



DREAMZZZ

71457





FR

DONNEZ
OU
RECYCLEZ



ASSOCIATION

OU



MAGASIN

OU



DÉCHÈTERIE

Adresses sur quefairedemesdechets.fr



LEGO.com/sustainable-packaging



BUILDER



Apple and the Apple logo are trademarks of Apple Inc., registered in the U.S. and other countries and regions. App Store is a service mark of Apple Inc. Google Play and the Google Play logo are trademarks of Google LLC. Tencent and the Tencent logo are trademarks of Tencent Inc.

Q LEGO.com/devicecheck

EN Ask parents' permission before going online | DE Eltern um Erlaubnis bitten, bevor du online gehst | FR Demande l'autorisation d'un parent avant d'aller en ligne | IT Chiedi il permesso ai tuoi genitori prima di andare online | ES Pídeles permiso a tus papás antes de conectarte a Internet | PT Pede autorização aos pais antes de acederes online | ZH 上网前应先征得父母的同意 | PL Poproś rodziców o zgodę, zanim wejdiesz do Internetu | CS Než půjdeš na internet, požádej rodiče o svolení | SK Skôr než půjdeš na internet, vypýtaj si povolenie od rodičov | HU Kérj szülői engedélyt, mielőtt online csatlakoznál! | RO Cere permisiunea părinților înainte de a te conecta online | BG Поискайте разрешение от родител, преди да влезете онлайн | LV Pirms došanās tiešsaistē palūdz atļauju vecākiem | ET Enne Interneti kasutamist küsi vanematelt luba | LT Prieš prisijungdami prie interneto, atsislauskite tėvų



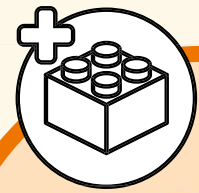
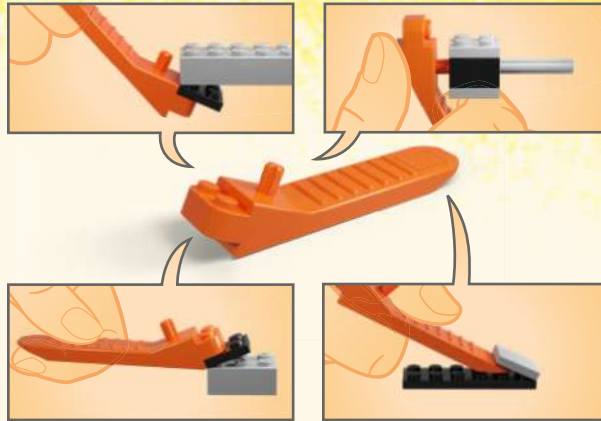

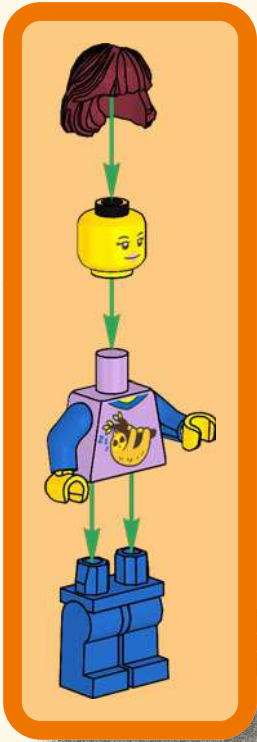
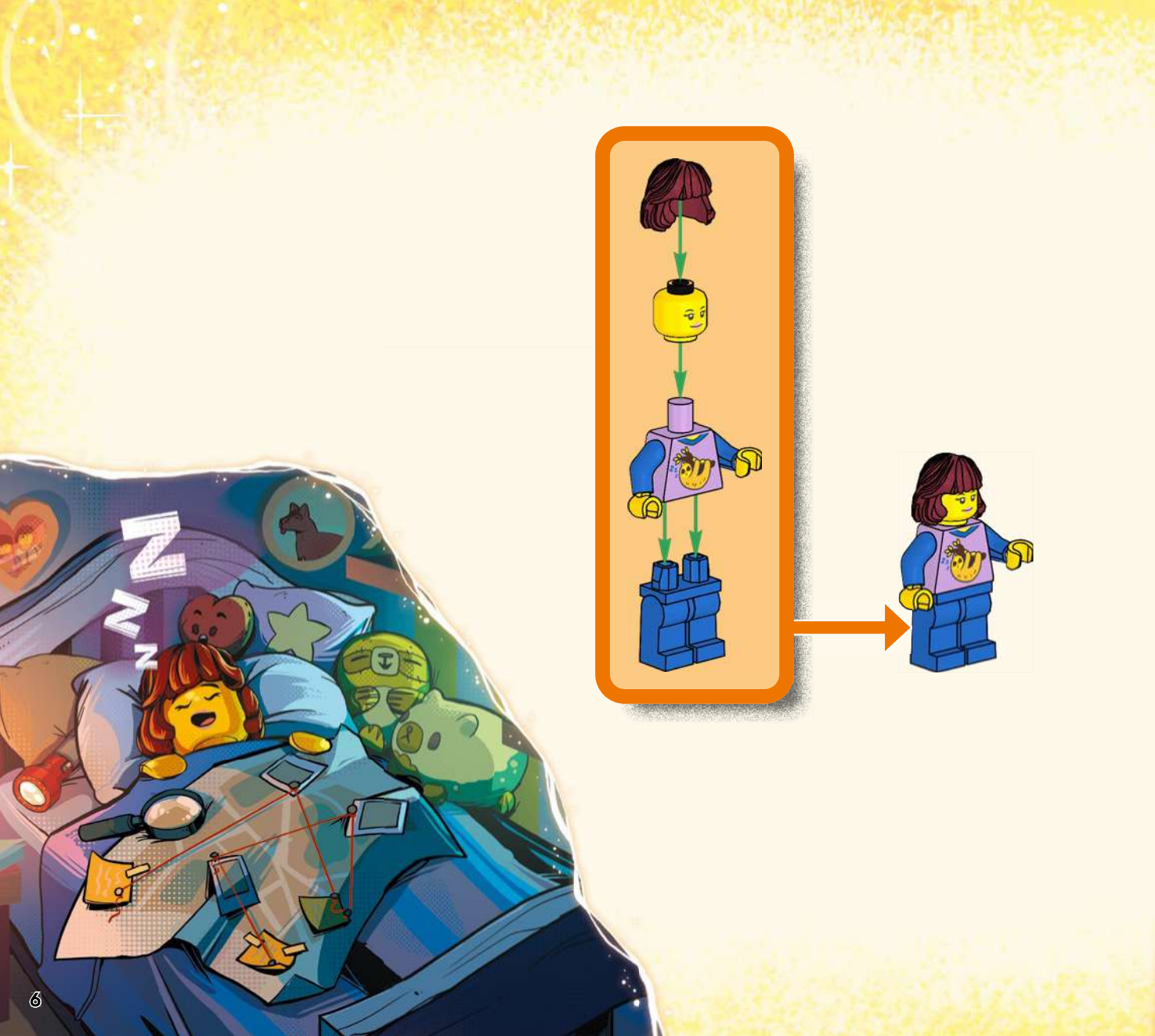



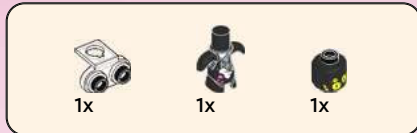

1





2



3

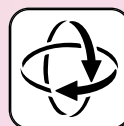



2x

4



1x

5

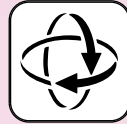

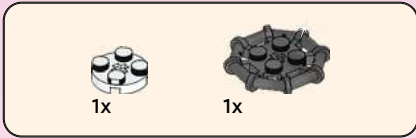

1

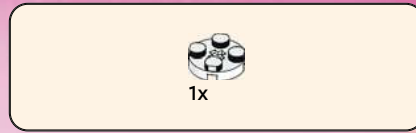

2

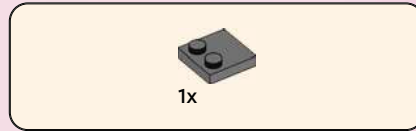

3





4

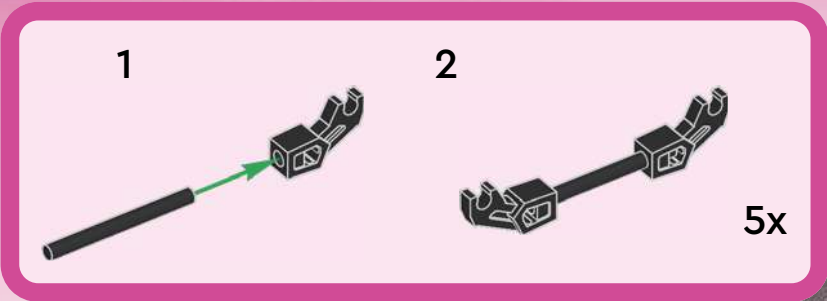

2

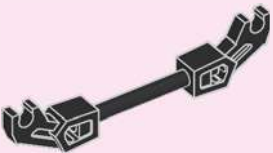

5x

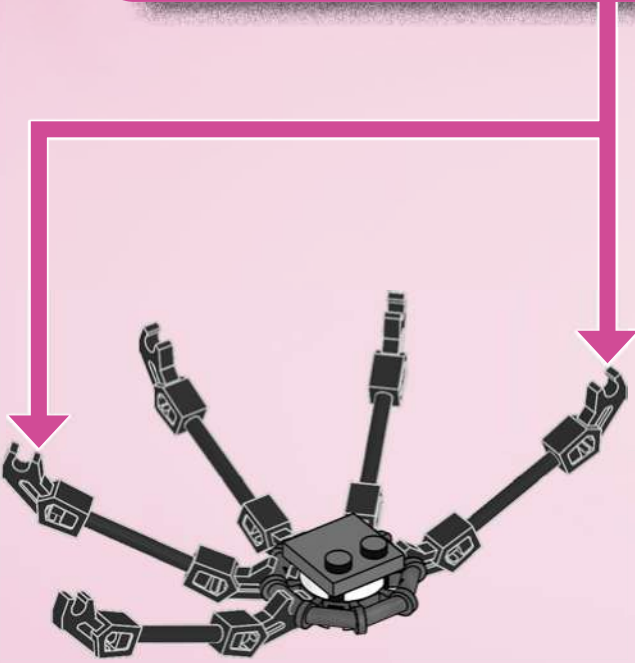



5

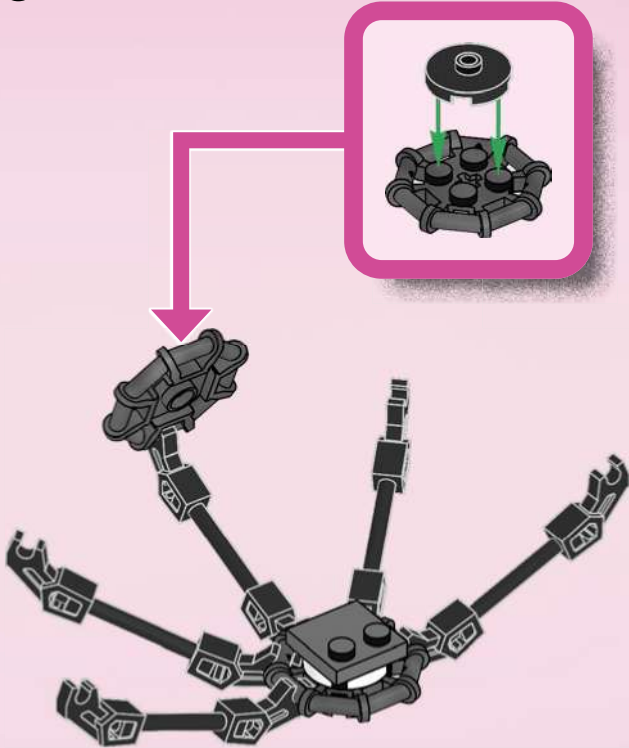

6





3x



3x

7

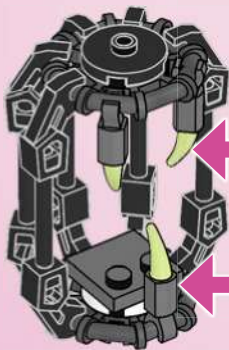
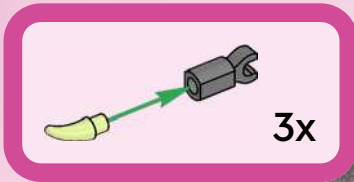

1x



1x



1x

8

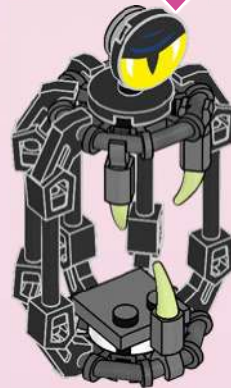
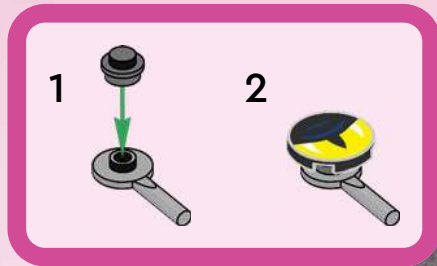



9

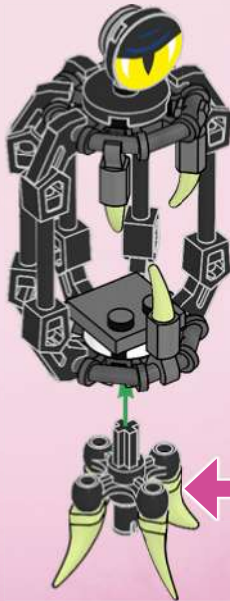
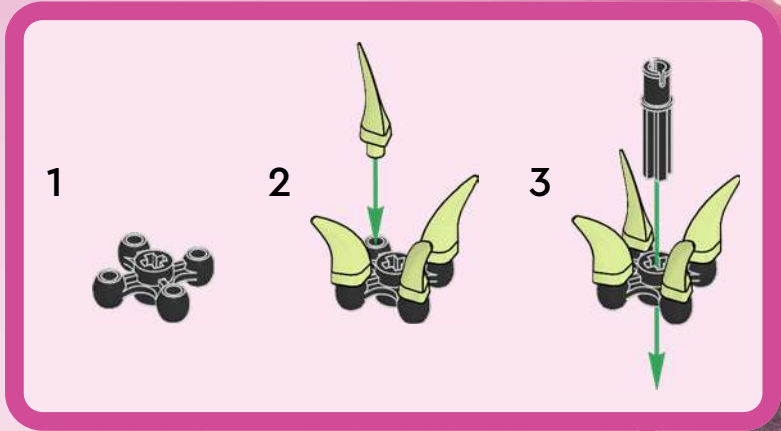

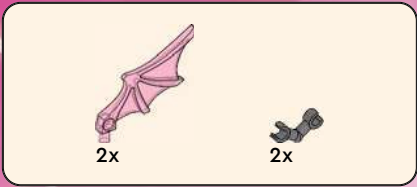

10

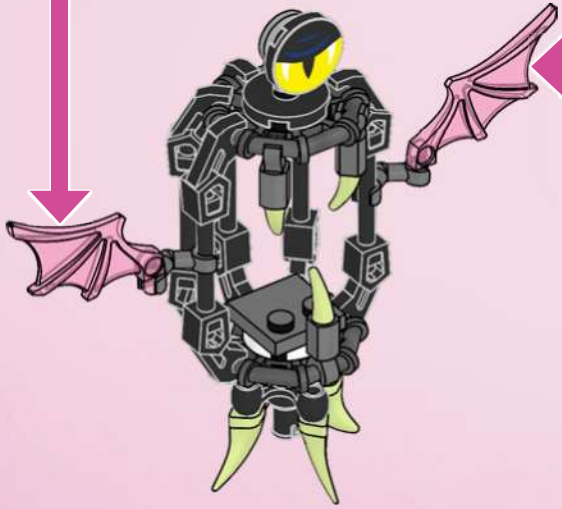
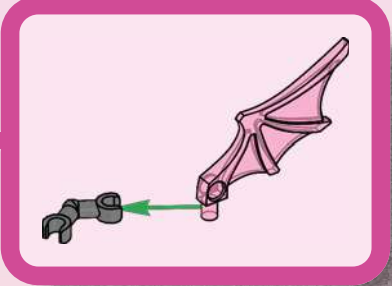
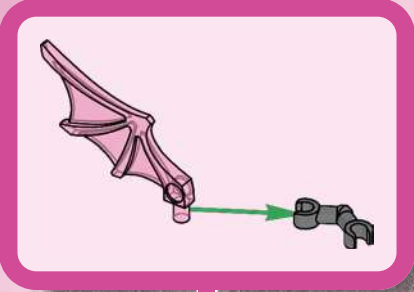

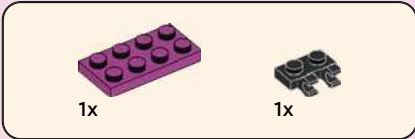
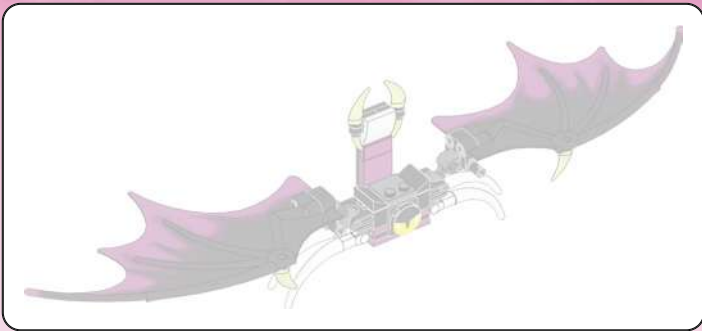

1



2



3





1x

4



2x

5



2x



1x

6



1x

7



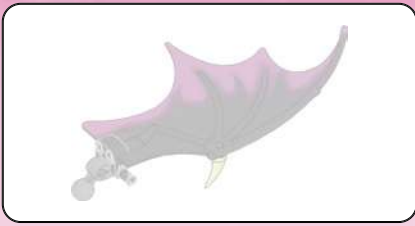

8



9

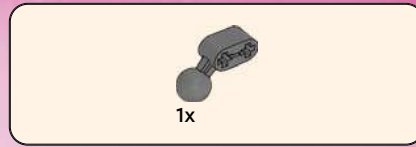

10

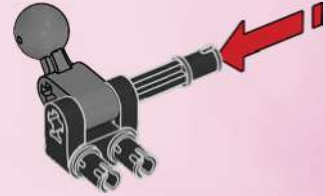

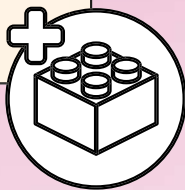

11

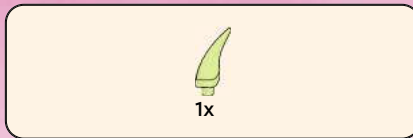

12



13

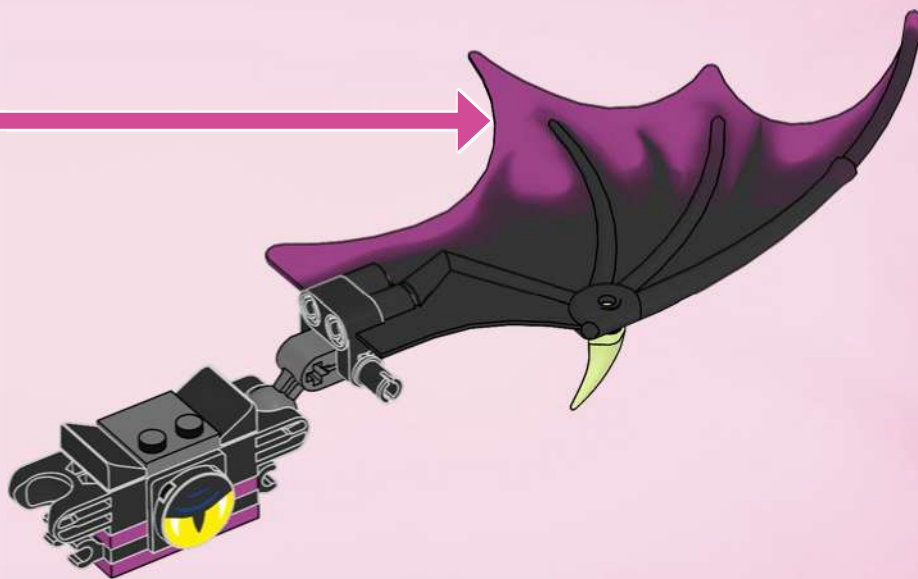

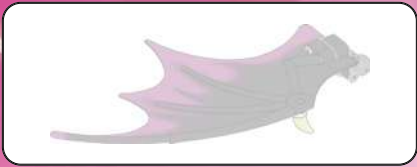

14



15

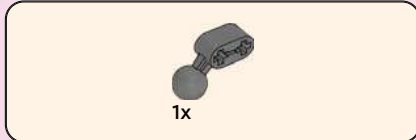

16

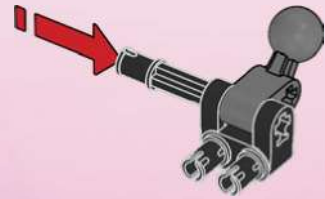

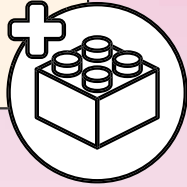
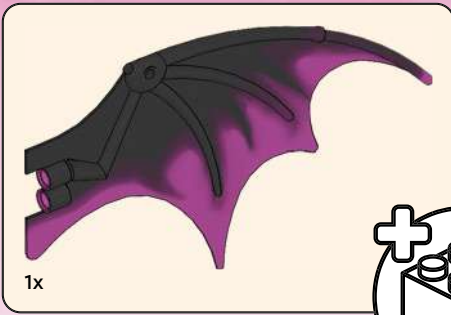

17





1x

18



19

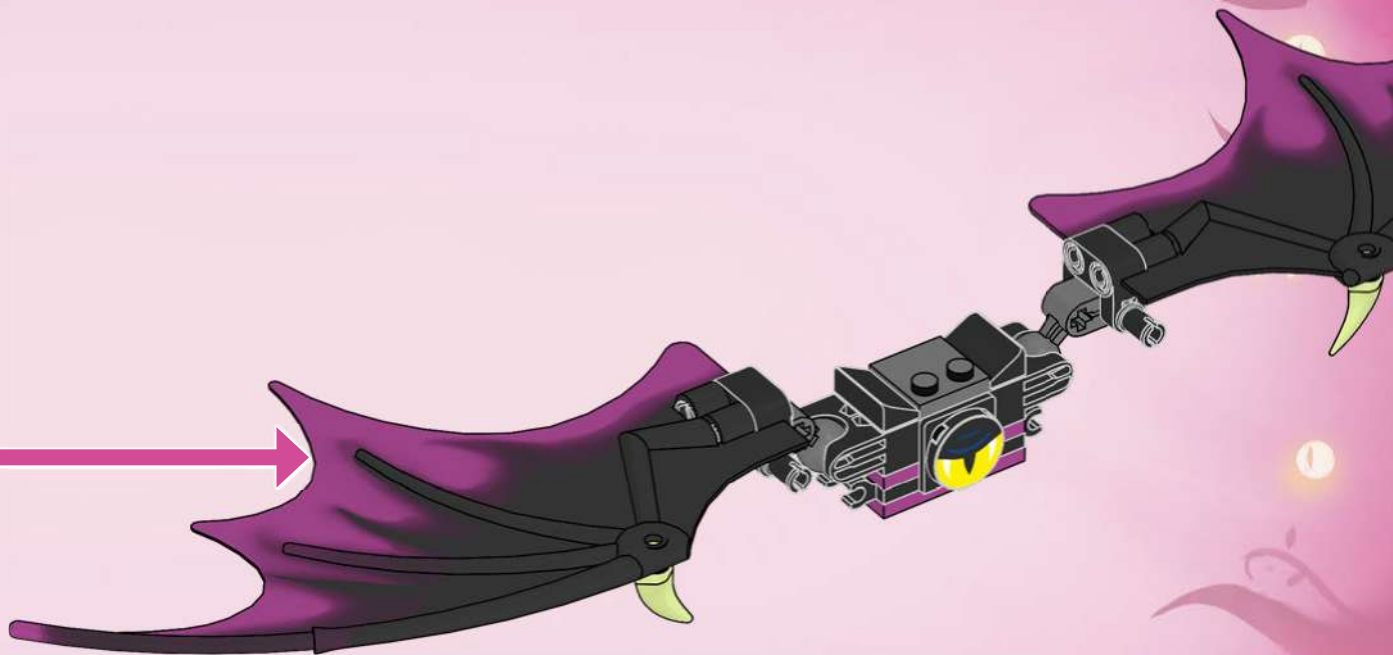



20

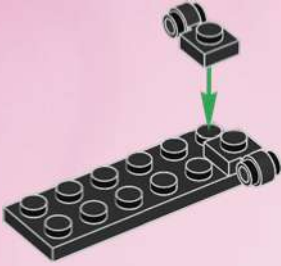

21

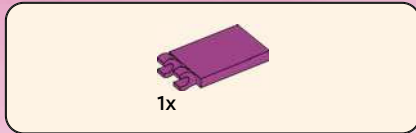

22

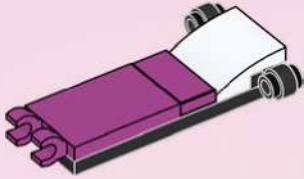

23

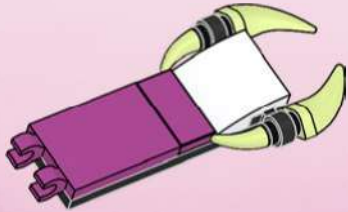

24

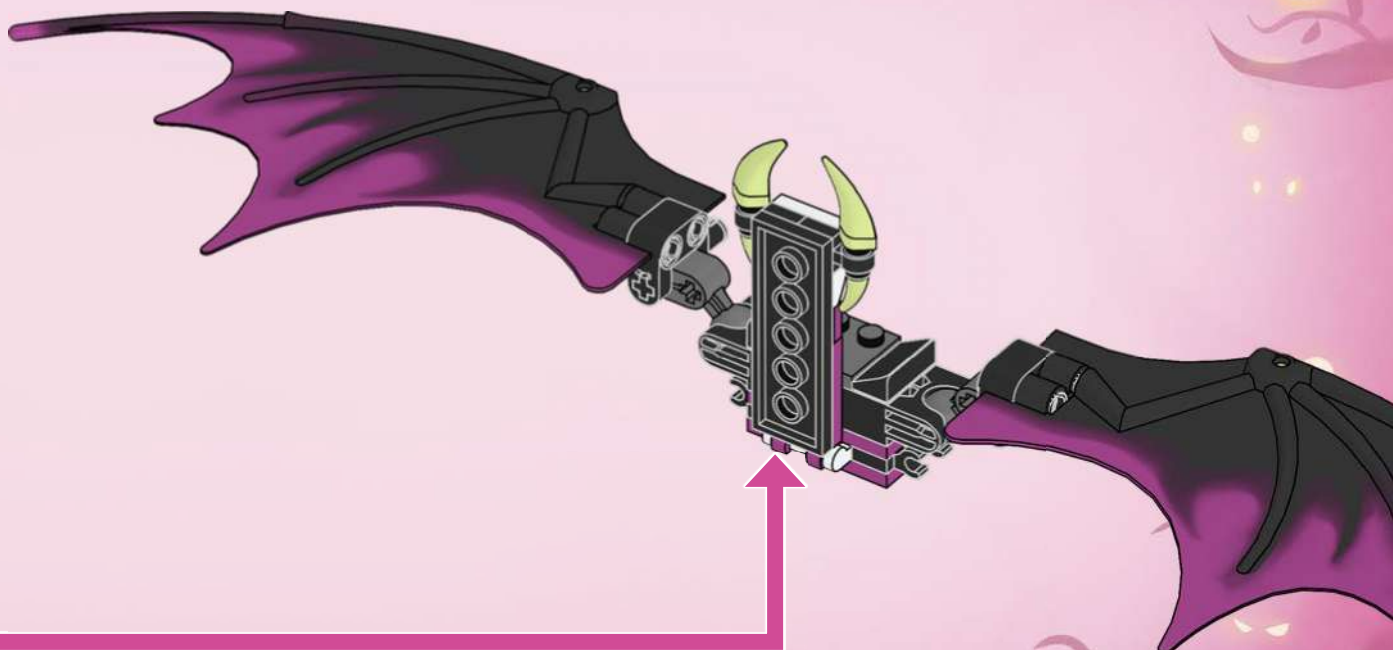

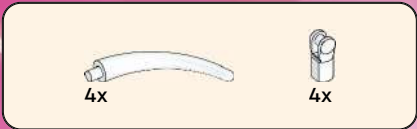

25

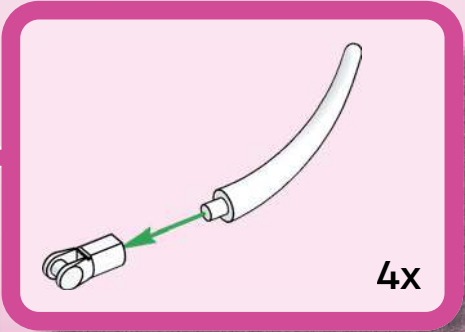
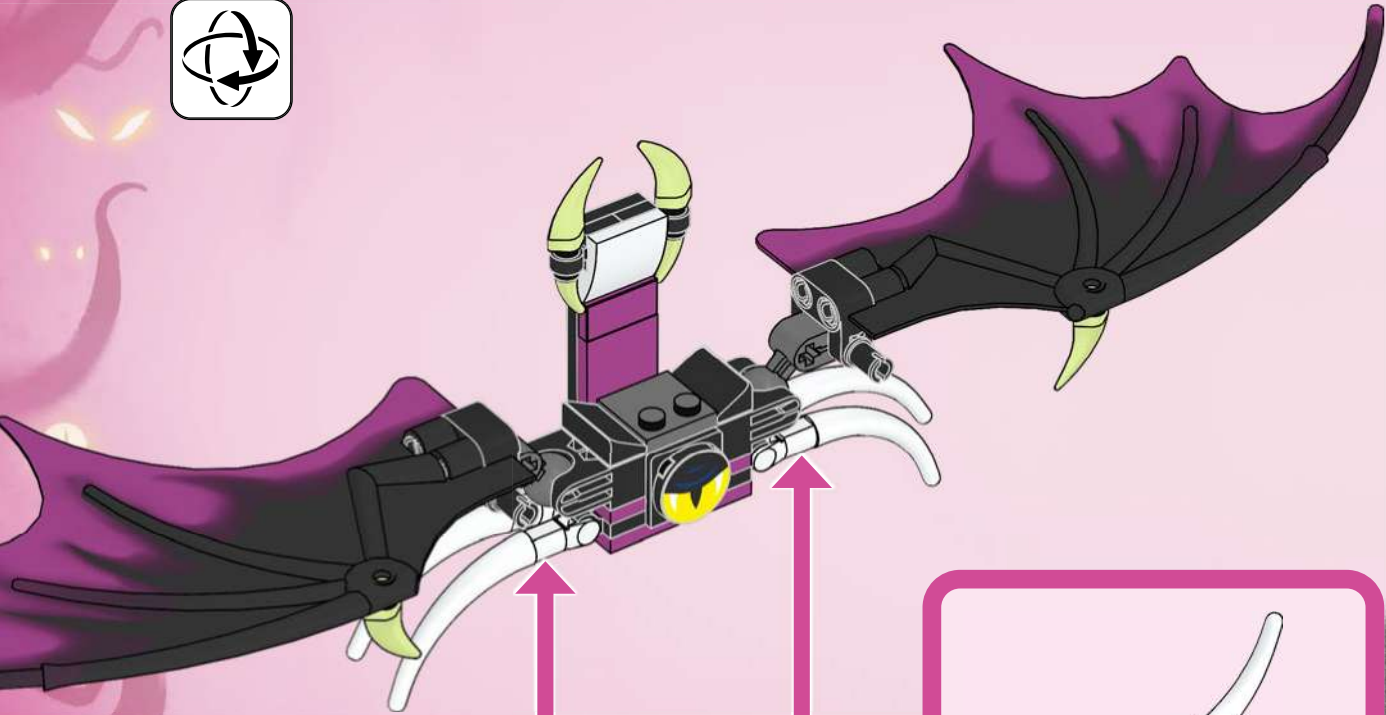

SWISSHH

FLAP

FLAP





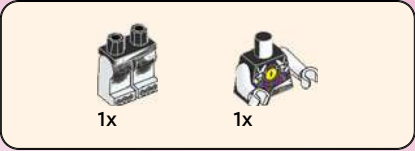

1

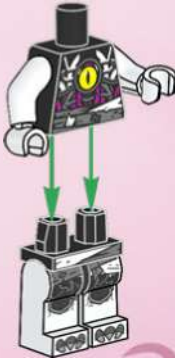



2

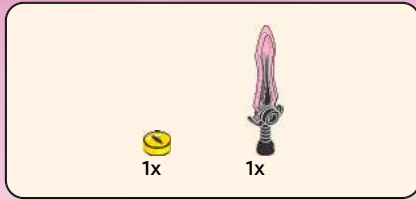

3





HAHA!!
HAHA!

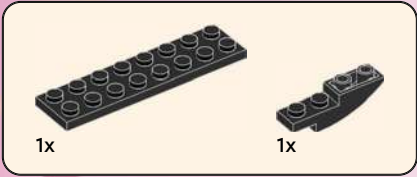
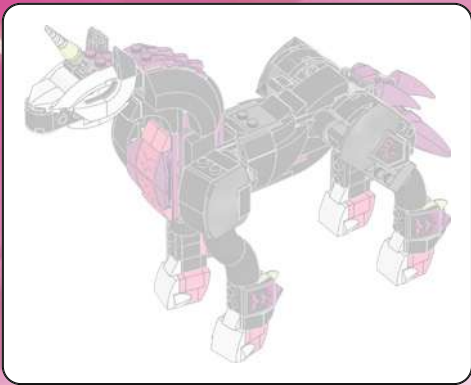

1

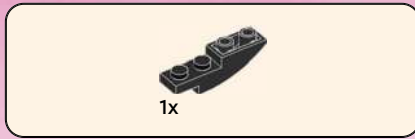
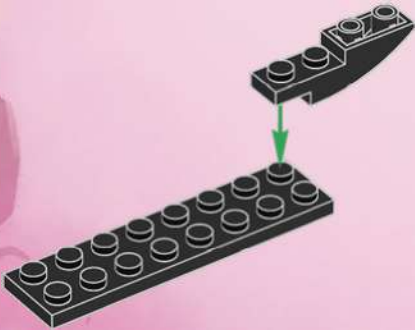

2

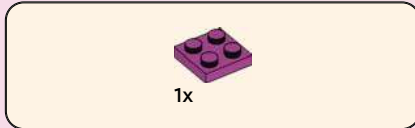
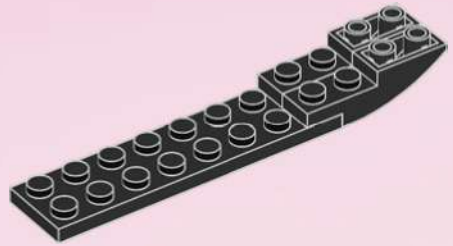

3

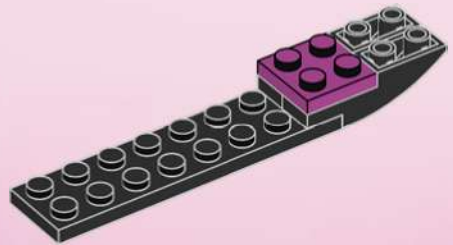

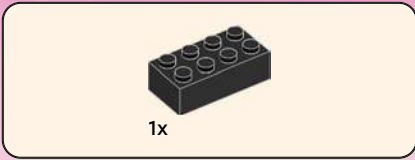

4

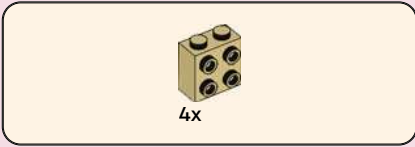
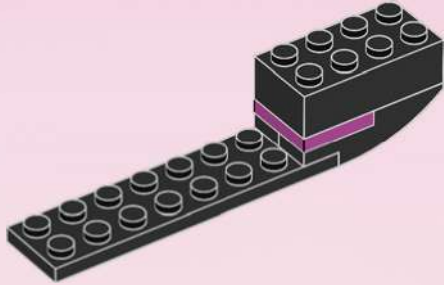

5

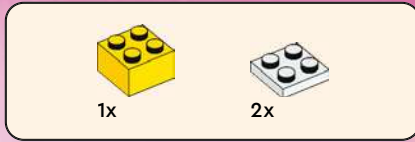
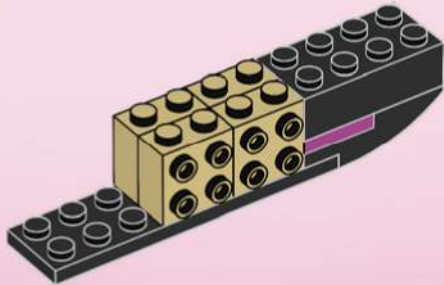

6

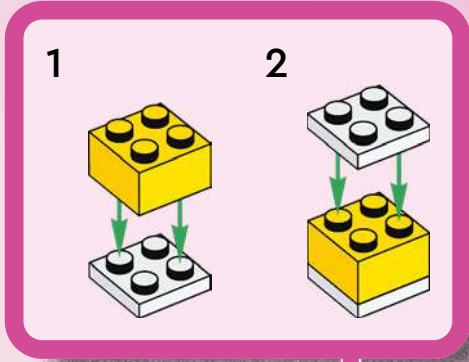



1x

7



2x

8

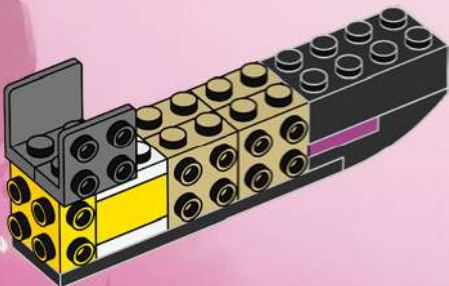

1x



1x

9

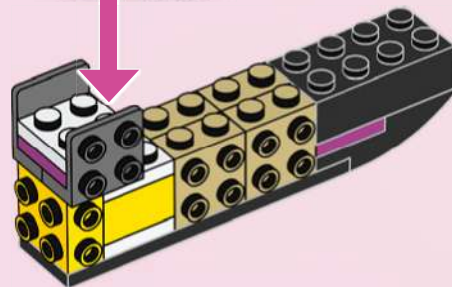
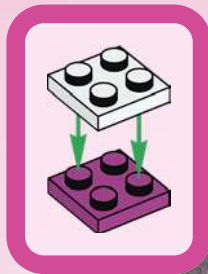

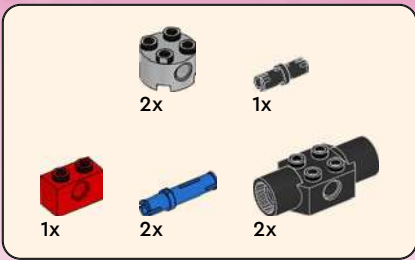

10

1

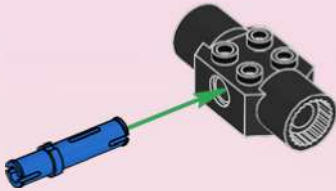

2

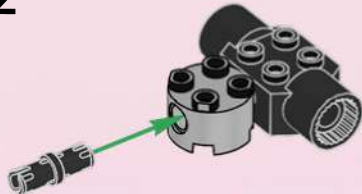

3

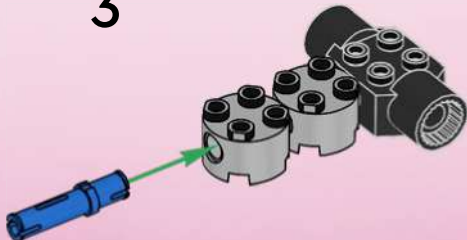

4



5

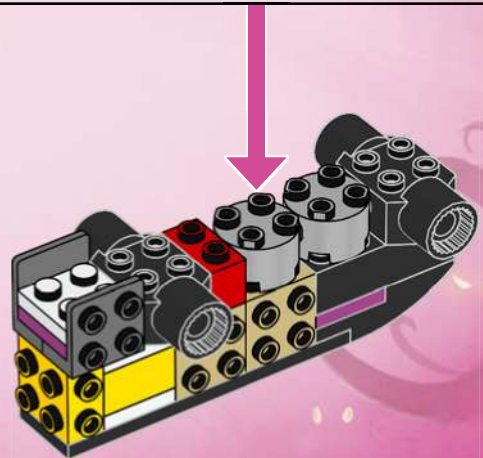

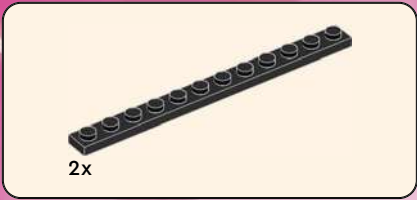

11

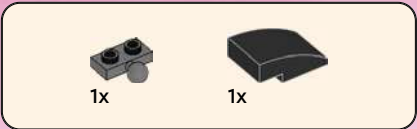
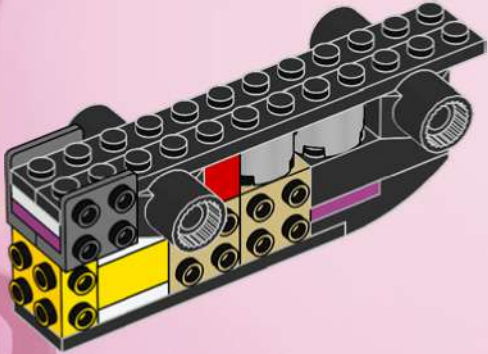

12

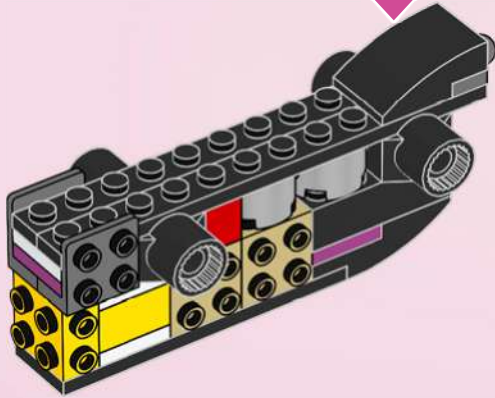



13

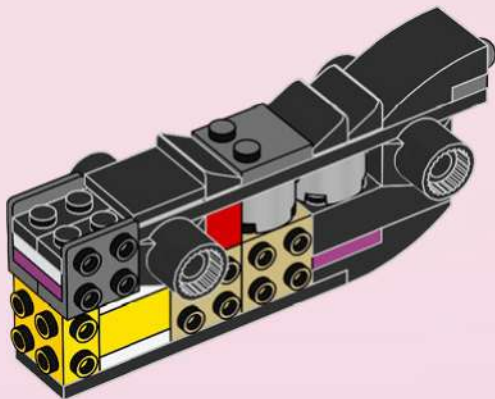

14



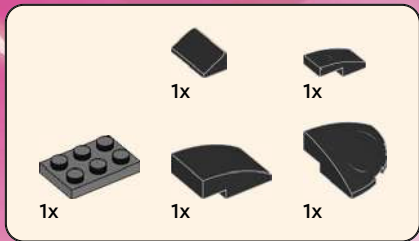

15

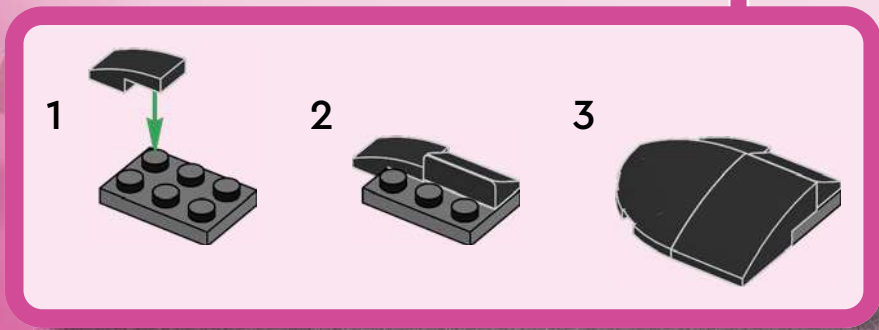
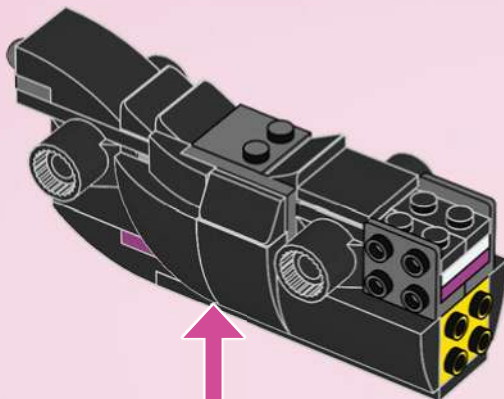

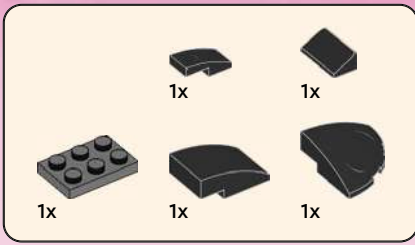

16

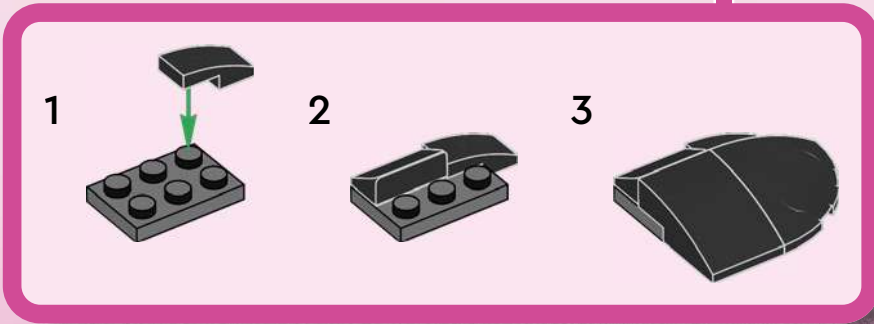
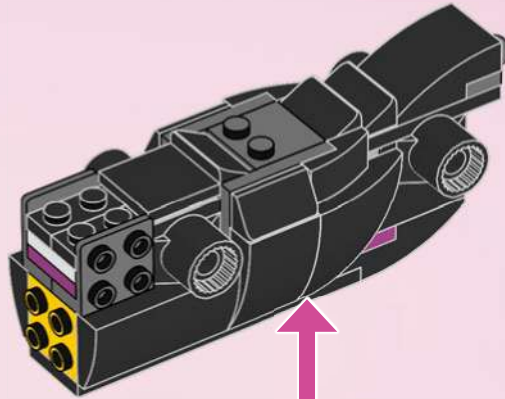



1x



1x

17



2x

18

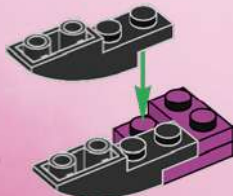

1x

19



2x

20





1x

21

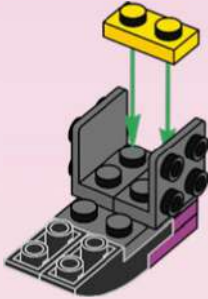

1x

22

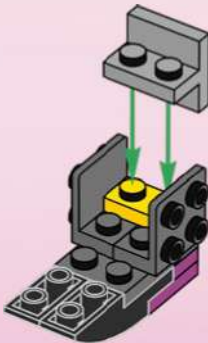

1x



1x

23

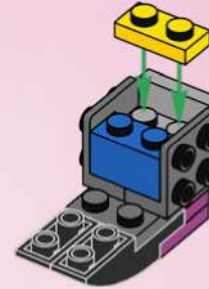

3x

24





1x



1x

25



1x

26



2x

27

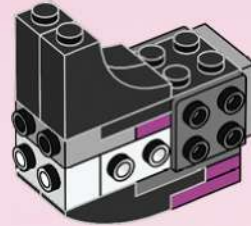

1x

28

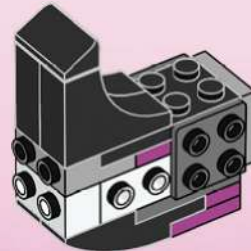

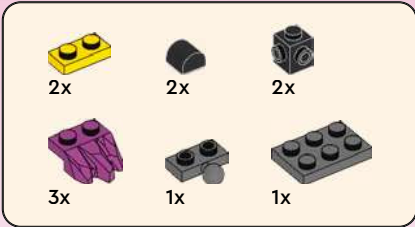

29

1

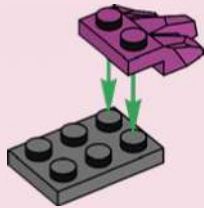

2

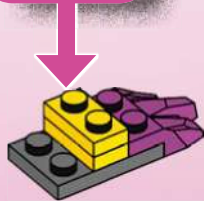
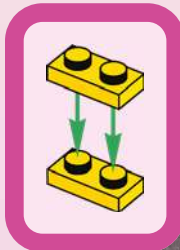

3



4



5



6



7

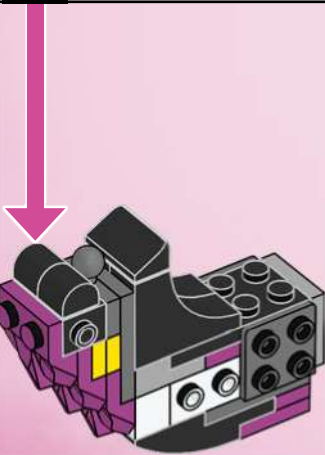

30

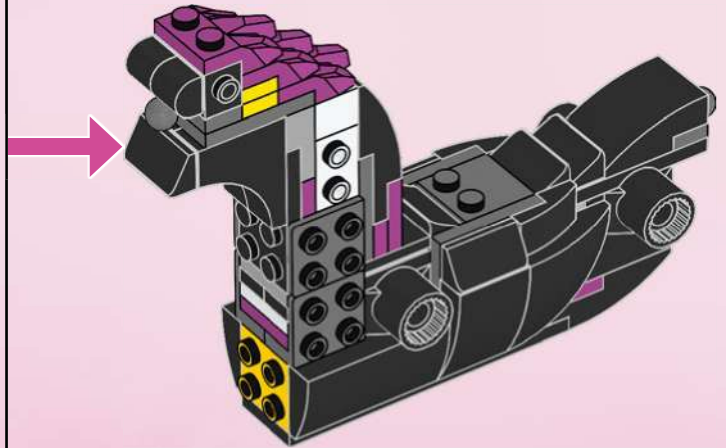

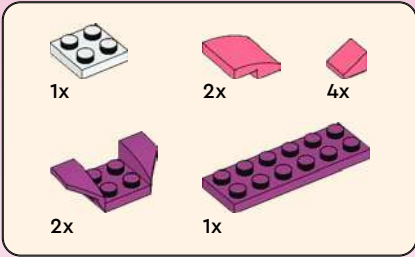

31

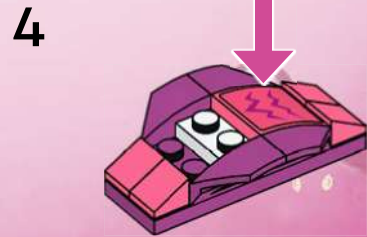
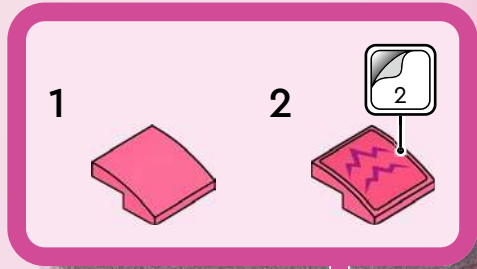
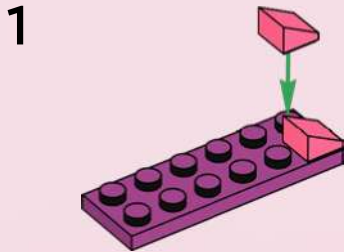

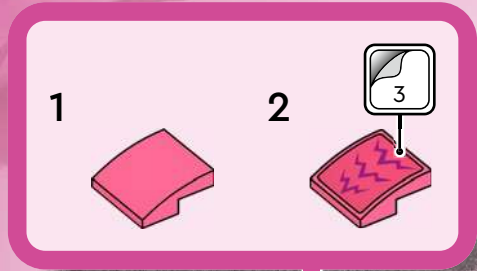

5

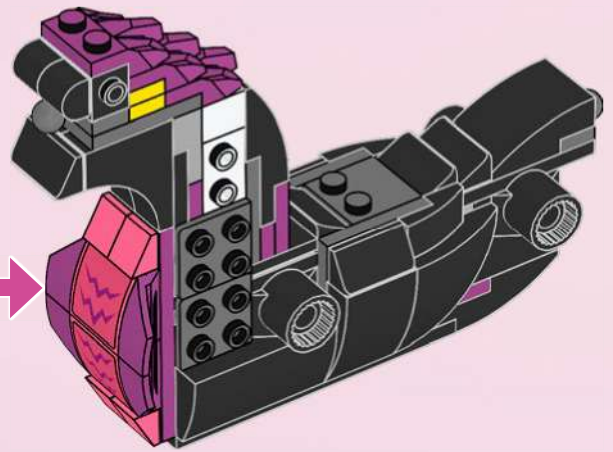
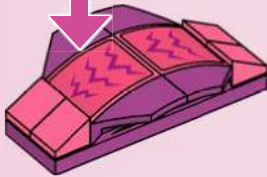



32

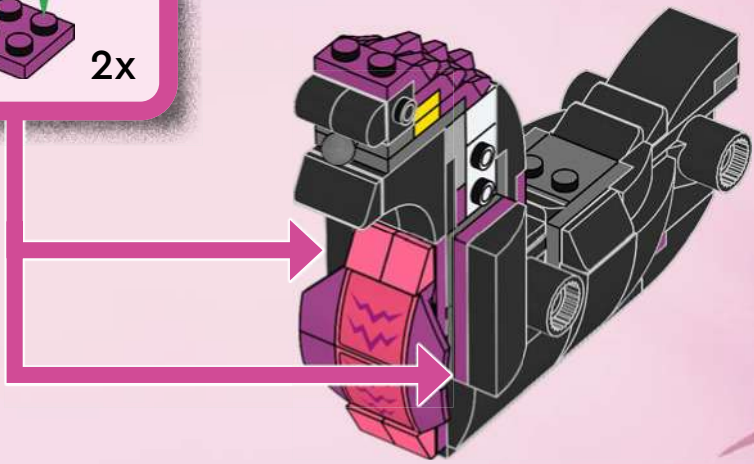
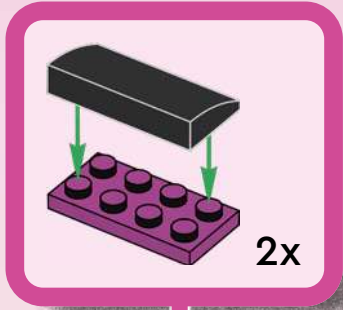



2x

33

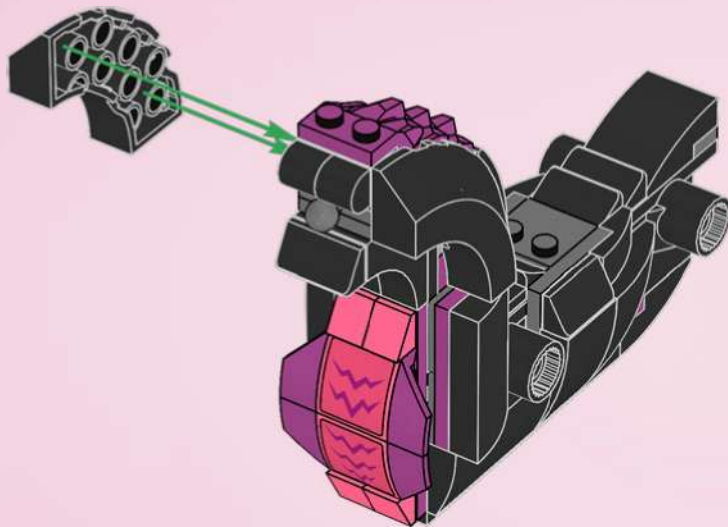





1x



1x

34

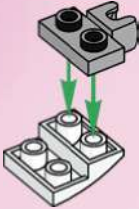

1x

35



1x

36



1x

37





2x

38



1x

39

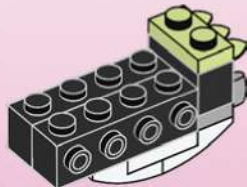

2x

40

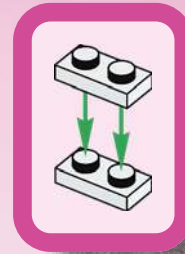

2x

41



2x





1x

42

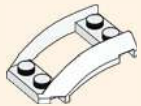

1x

43



1x

44

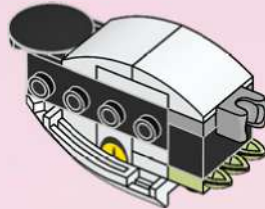

1x

45

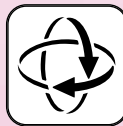



1x



1x

46

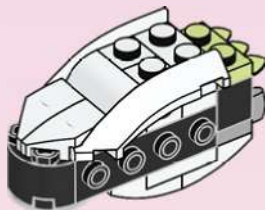

2x



1x

47

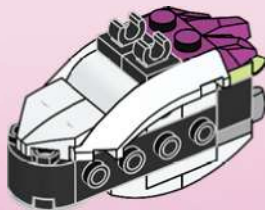

1x



1x



1x



1x

48

1

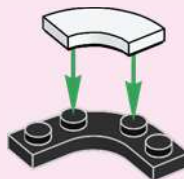

2

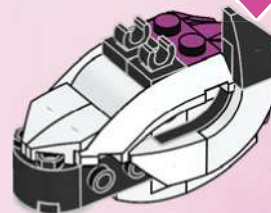



49

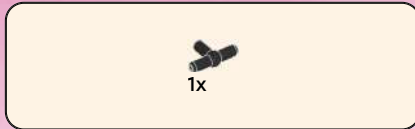
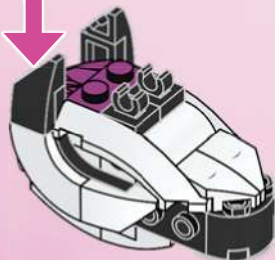
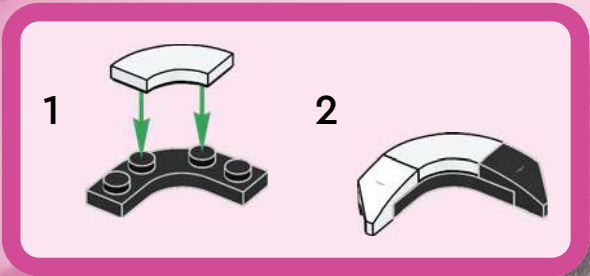

50

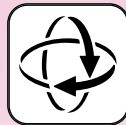

51





52

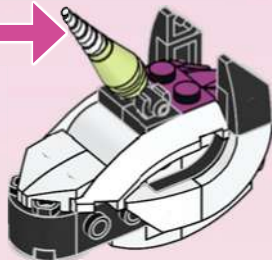

53

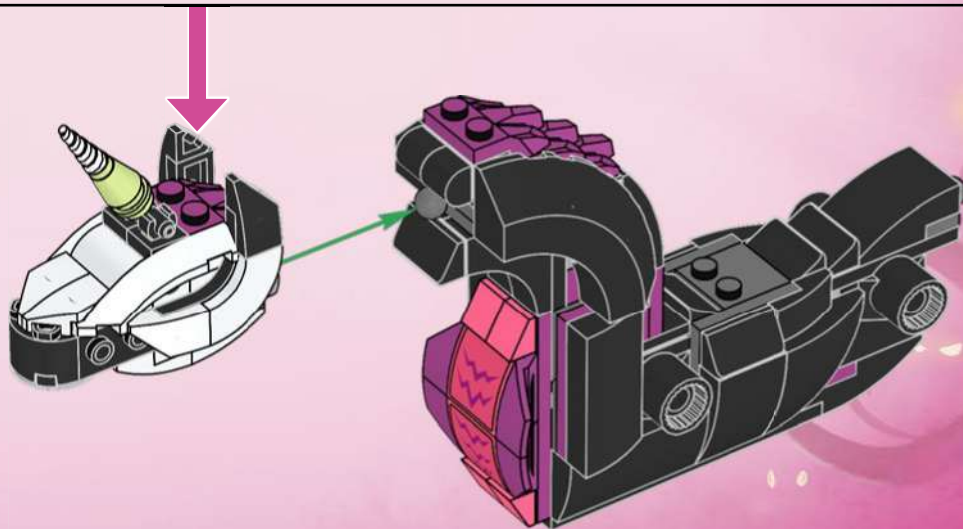



1x



1x

54

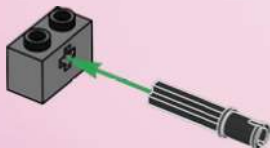

1x



1x

55

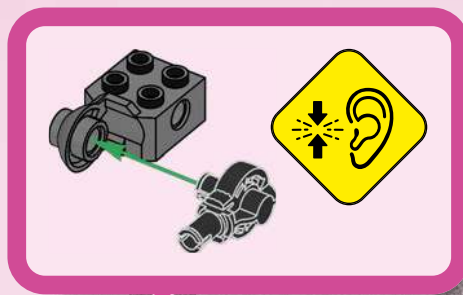



1x

56

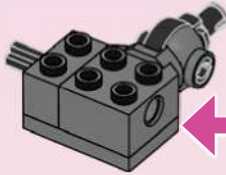

2x



1x

57



1x

58



1x



1x

59





1x

60



2x

61



1x



1x

62

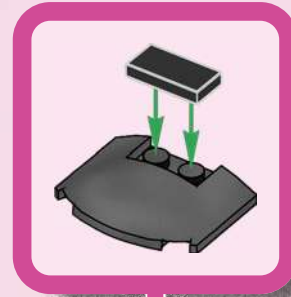

63

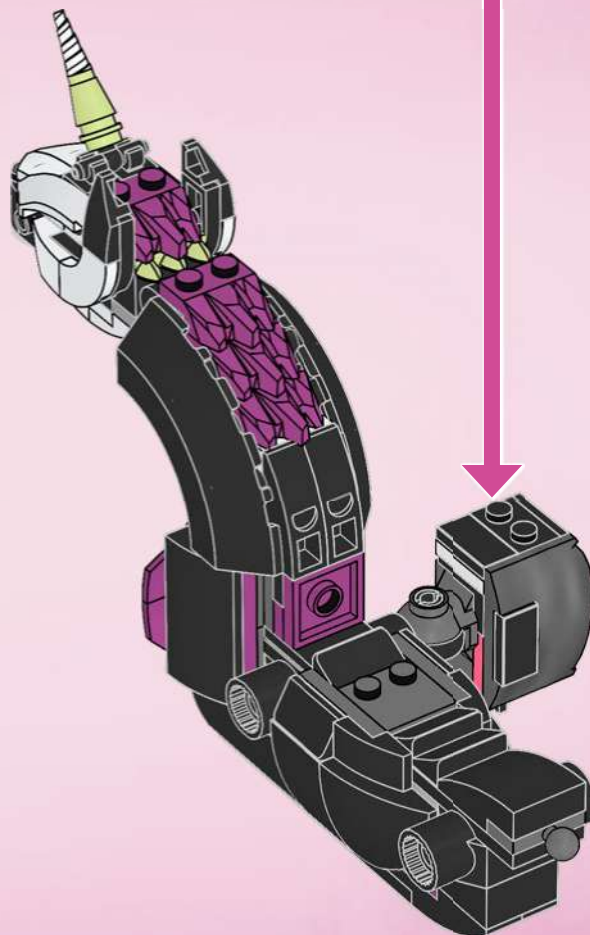

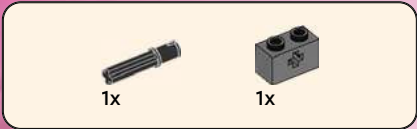

64

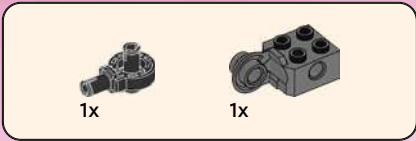
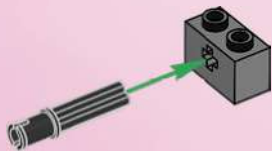

65

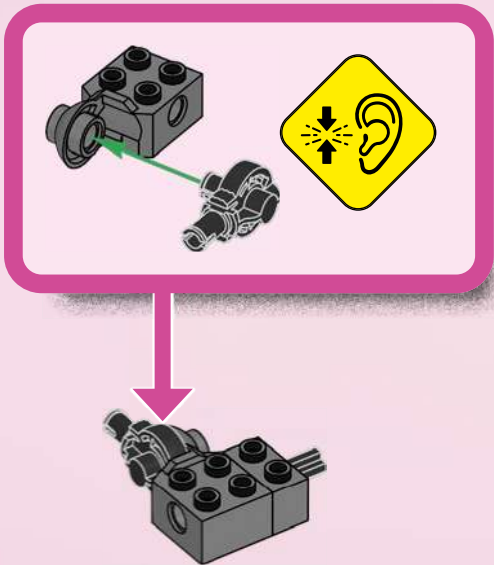



1x

66



2x



1x

67



1x

68



1x



1x

69





1x

70



2x

71



1x



1x

72

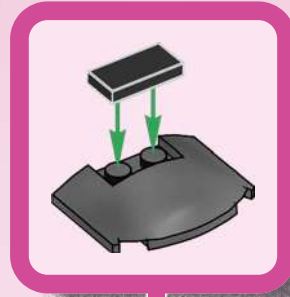

73

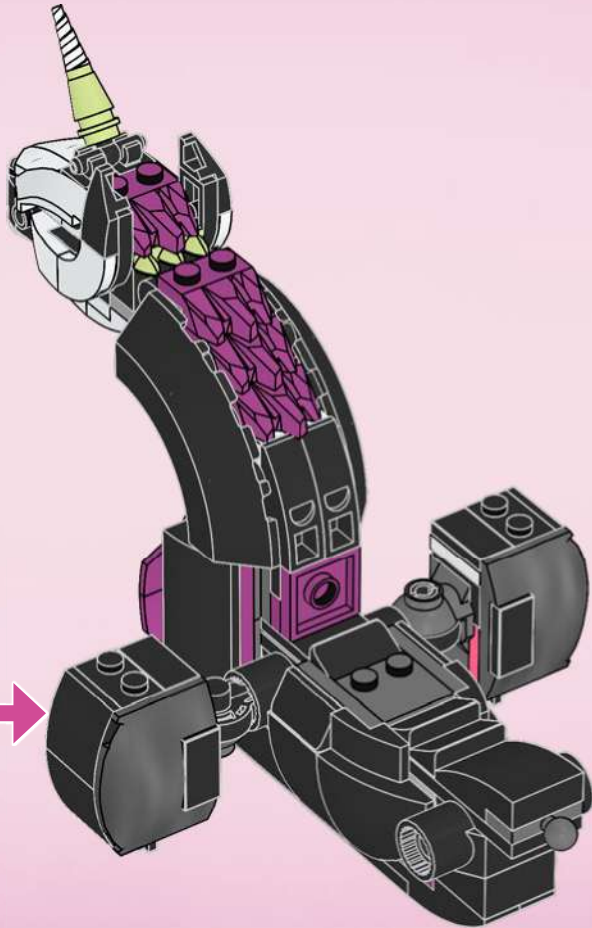

74





1x

75



2x

76



1x

77



1x

78





1x

79



1x



1x



1x

80

1



2



1x

81

1



2

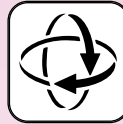

1x



1x

82



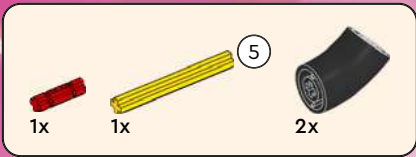

83

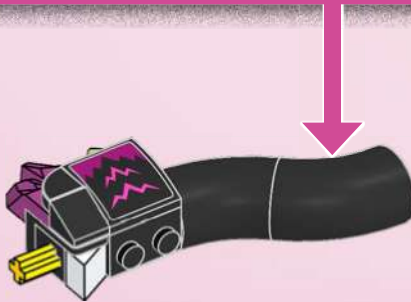

84

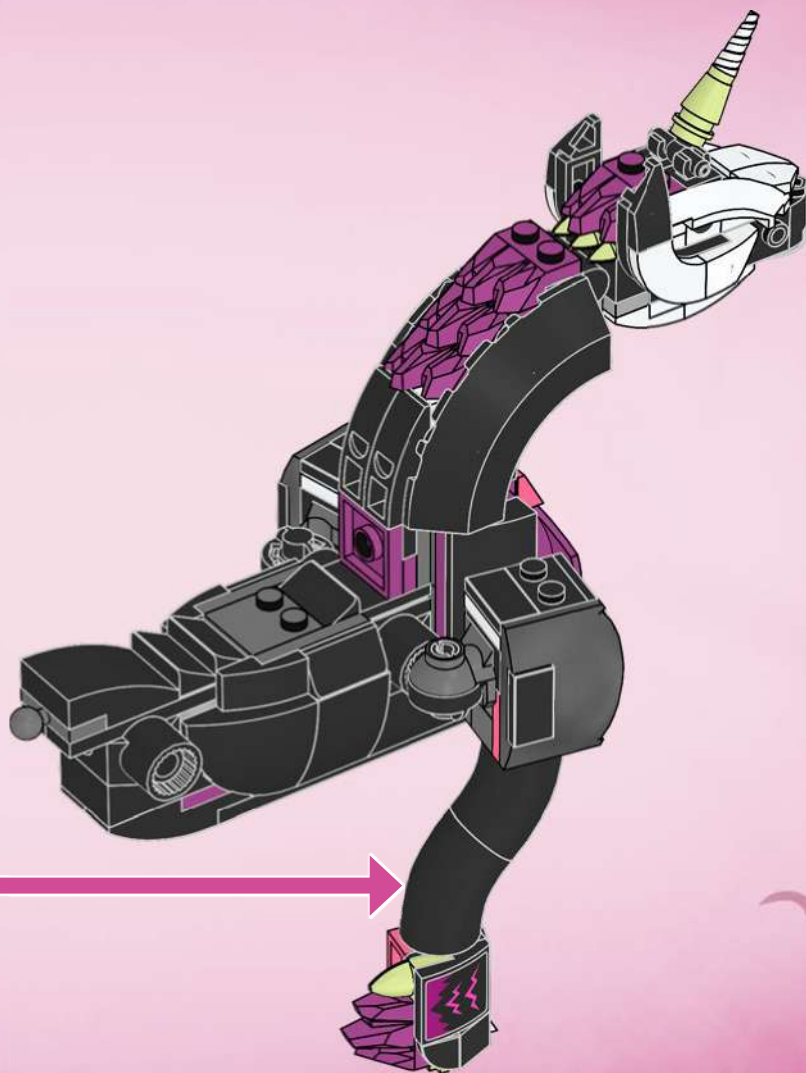



1x

85



2x

86



1x

87



1x

88





1x

89



1x



1x



1x

90

1



2



1x

91

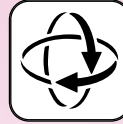

1



2



1x



1x

92



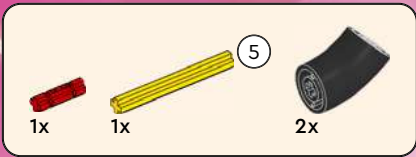

93



94

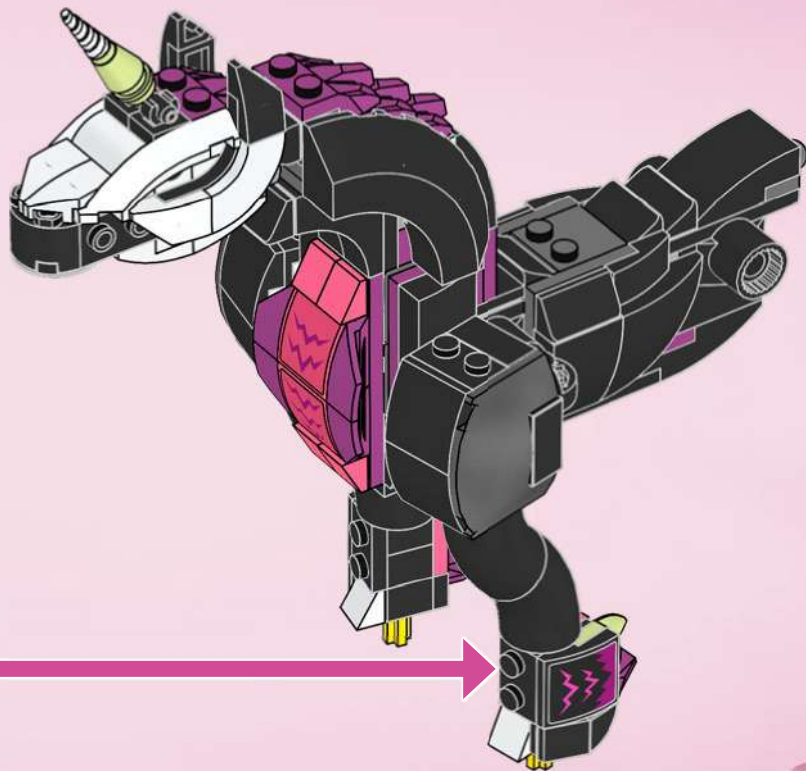



2x



4x



2x



2x



4x



4x

95

1



2



3



4



5



6



2x

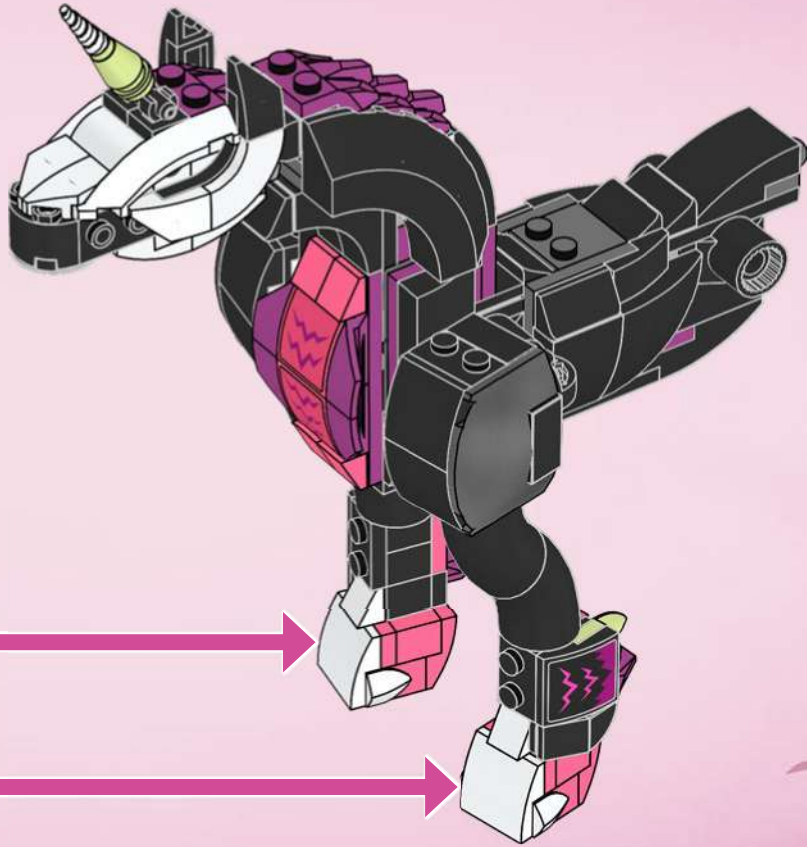





96

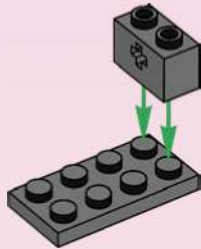

97

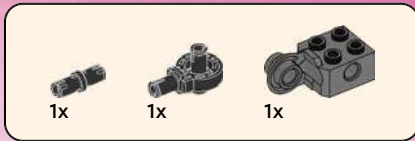

98

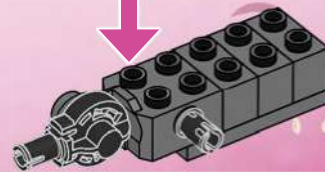
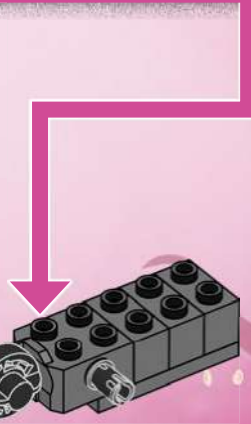
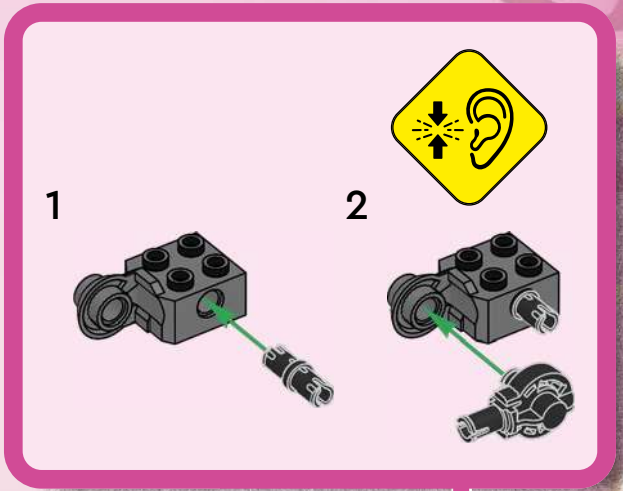

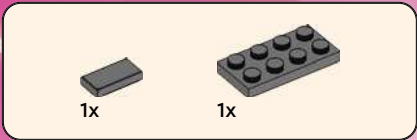

99

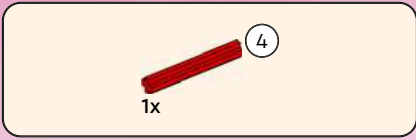
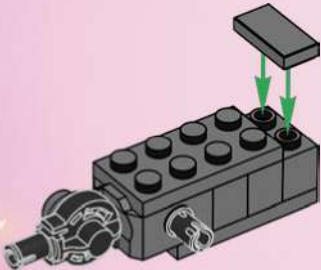

100

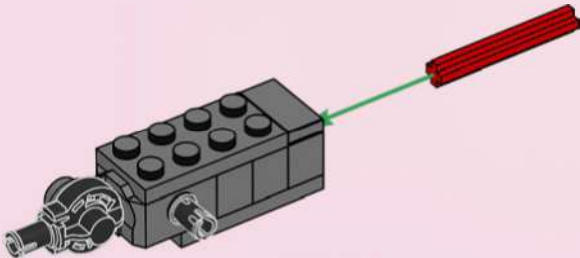

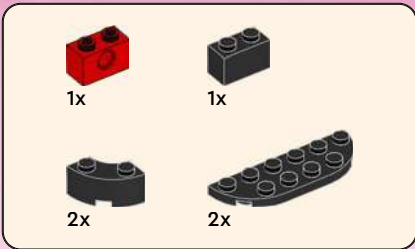

101

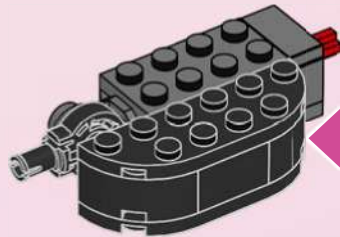
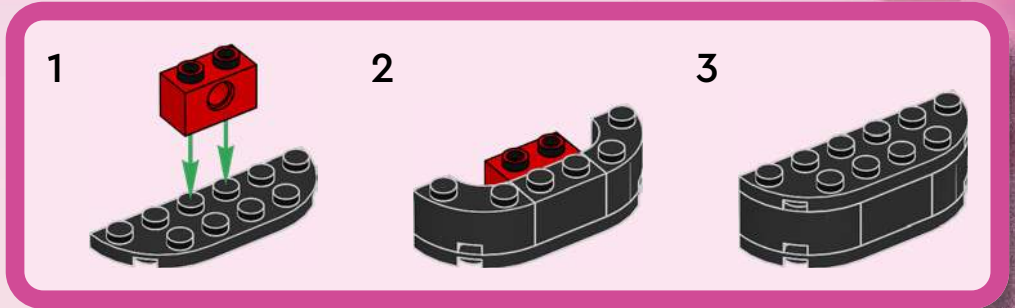

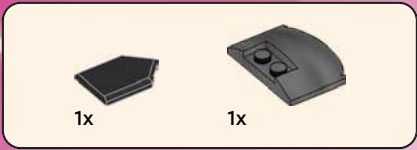

102

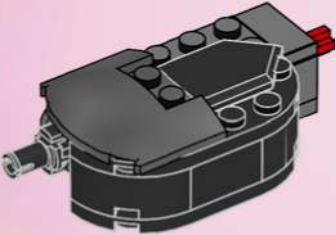

103

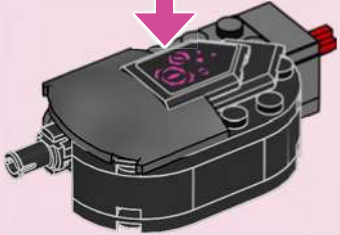
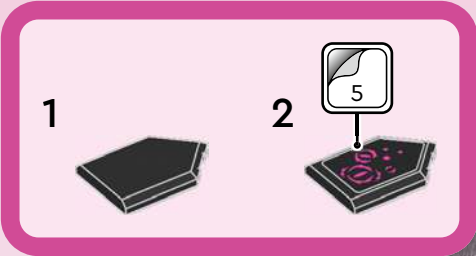

104



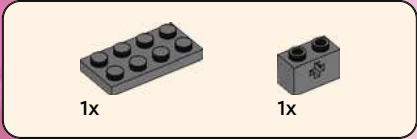

105

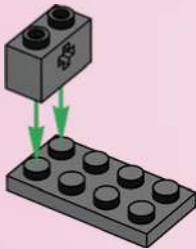

106

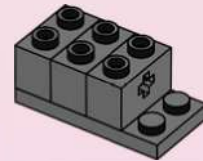



107

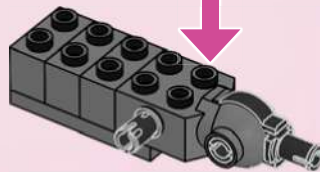
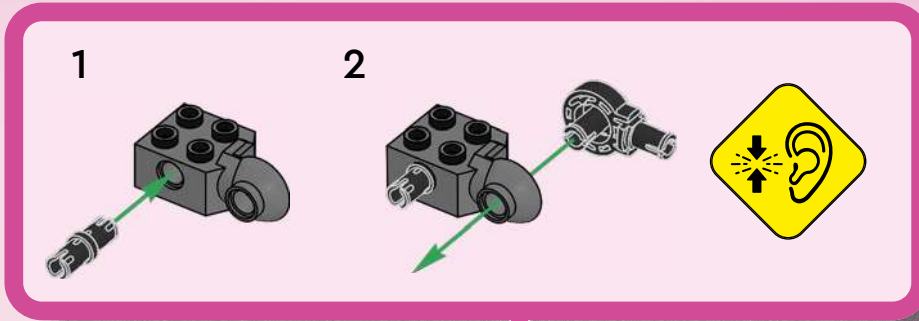

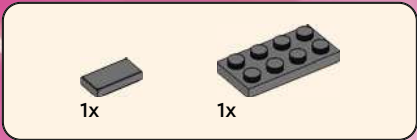

108

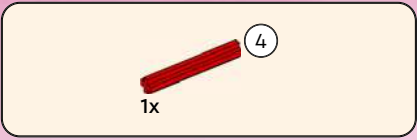
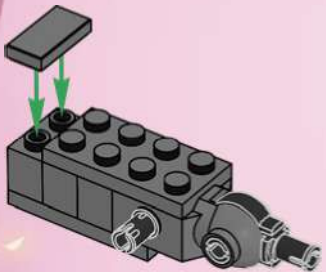

109

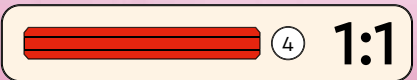
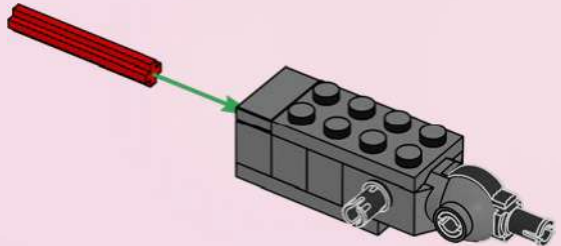

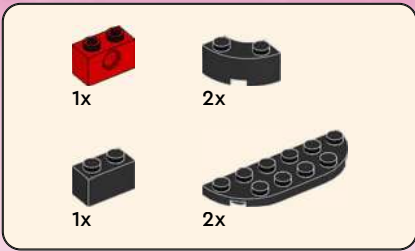

110

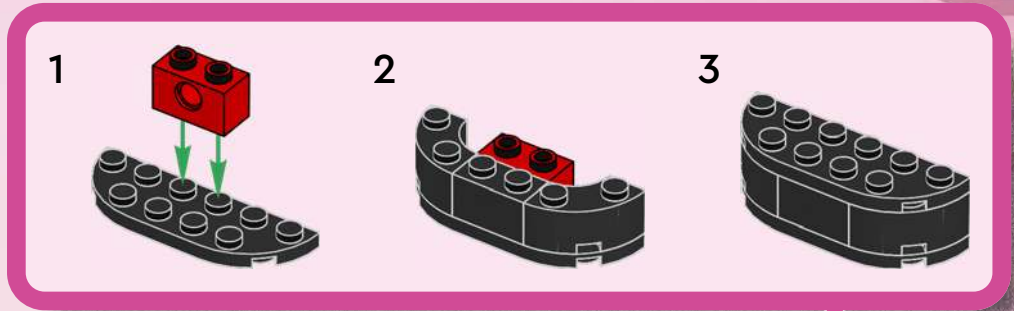

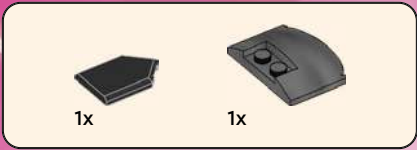

111

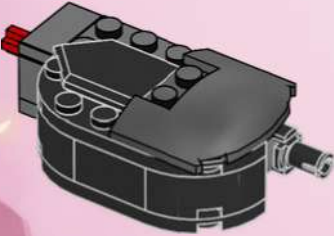

112

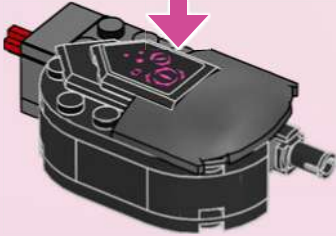

113

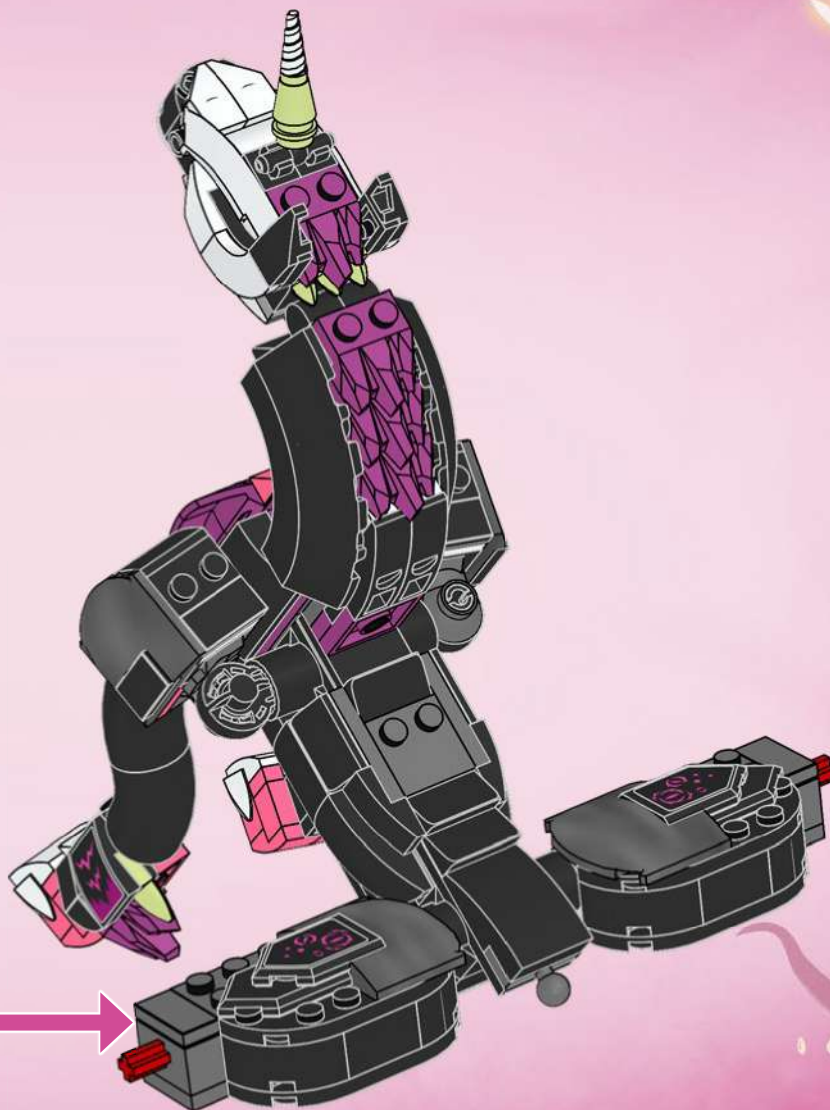

114

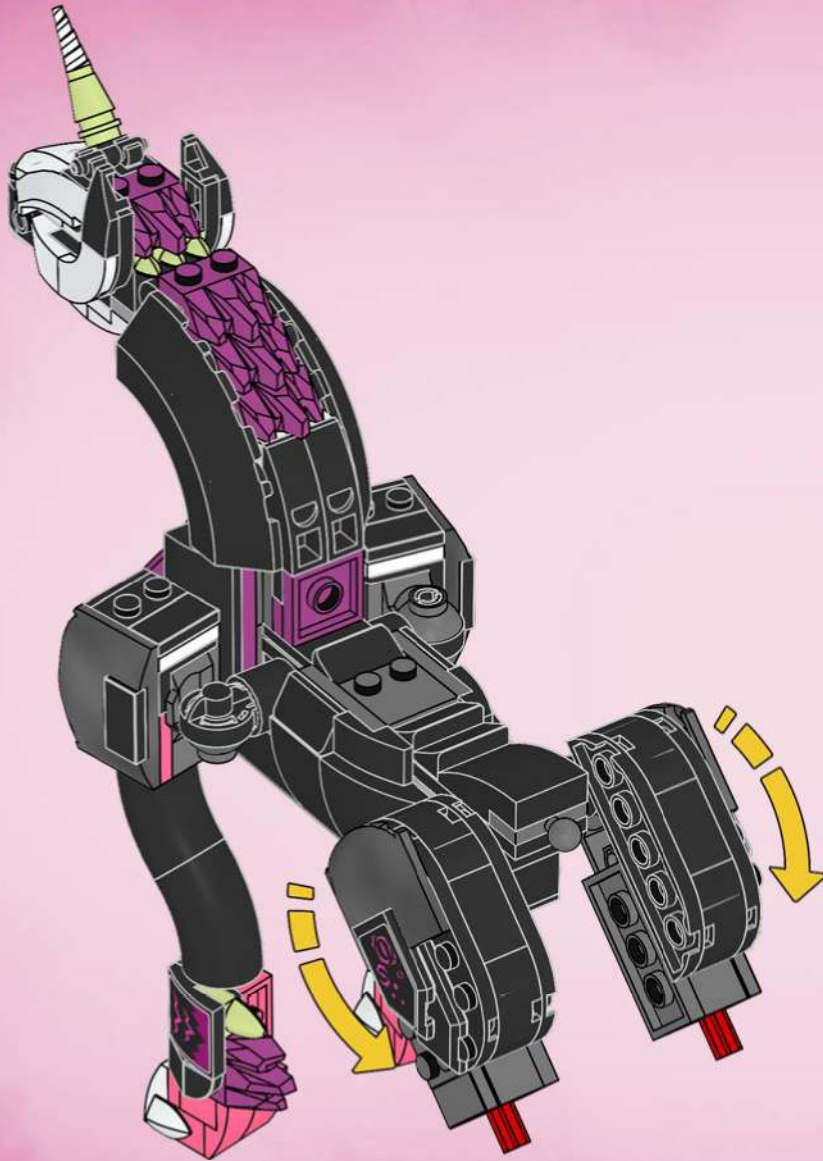



1x

115



2x

116



1x

117



1x

118





1x

119



1x



1x



1x

120

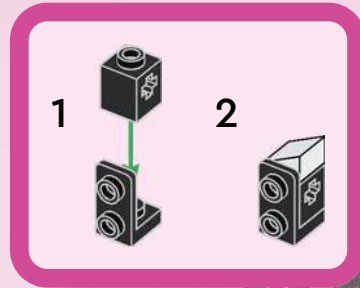



121

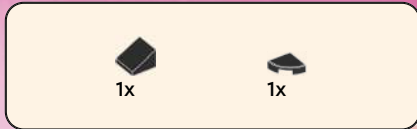

122



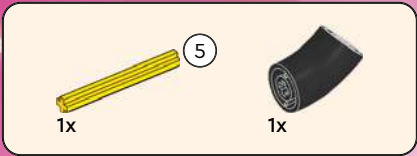

123

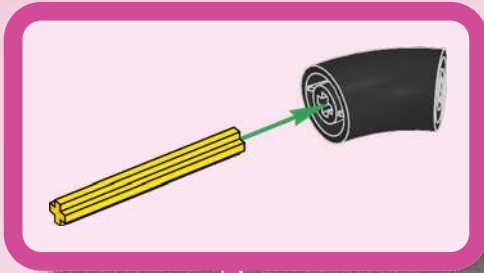

124

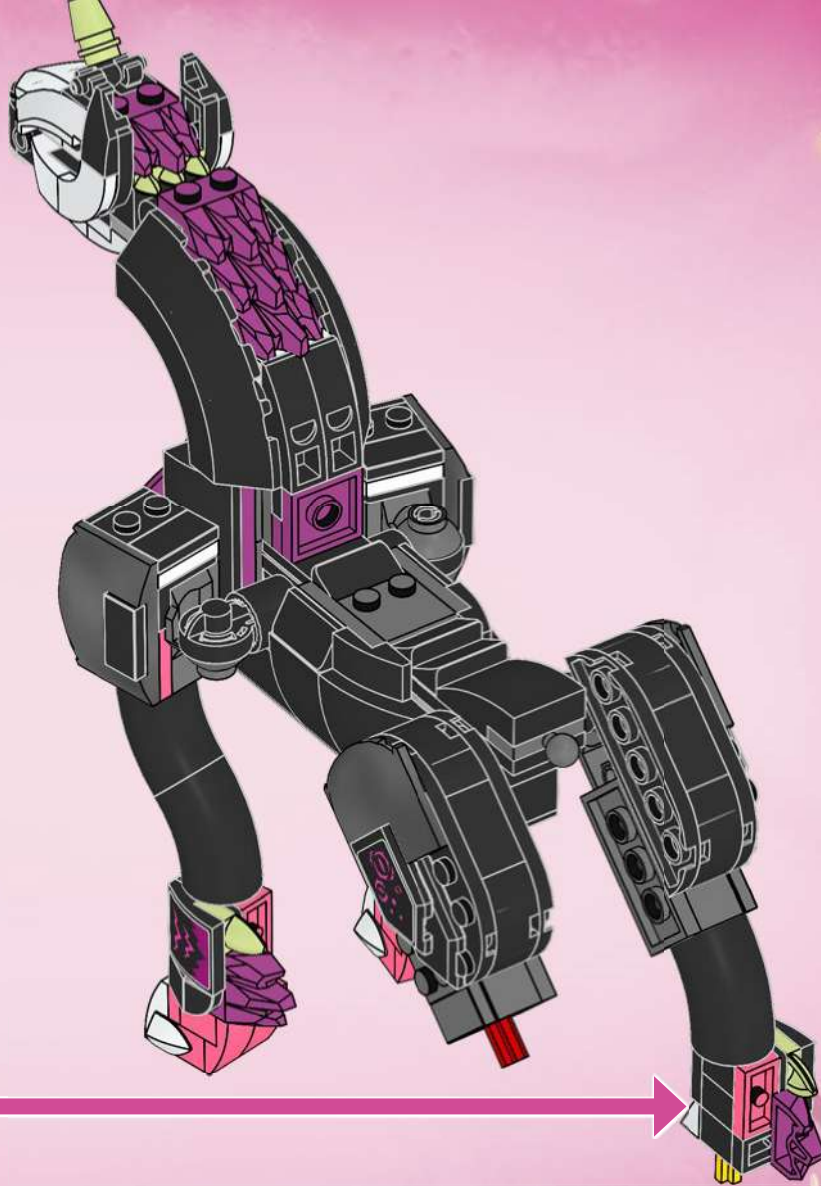



1x

125



2x

126



1x

127





1x

128



1x

129





1x



1x



1x

130

1



2

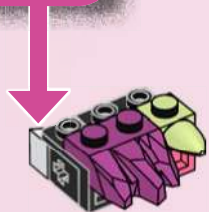



1x

131



1x



1x

132



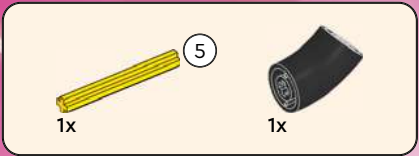

133

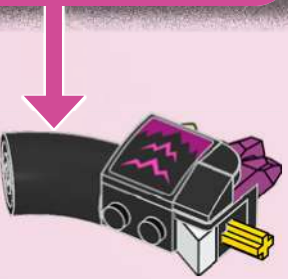
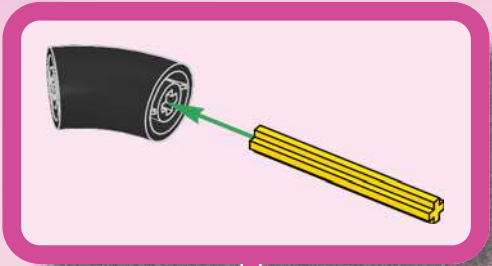

134

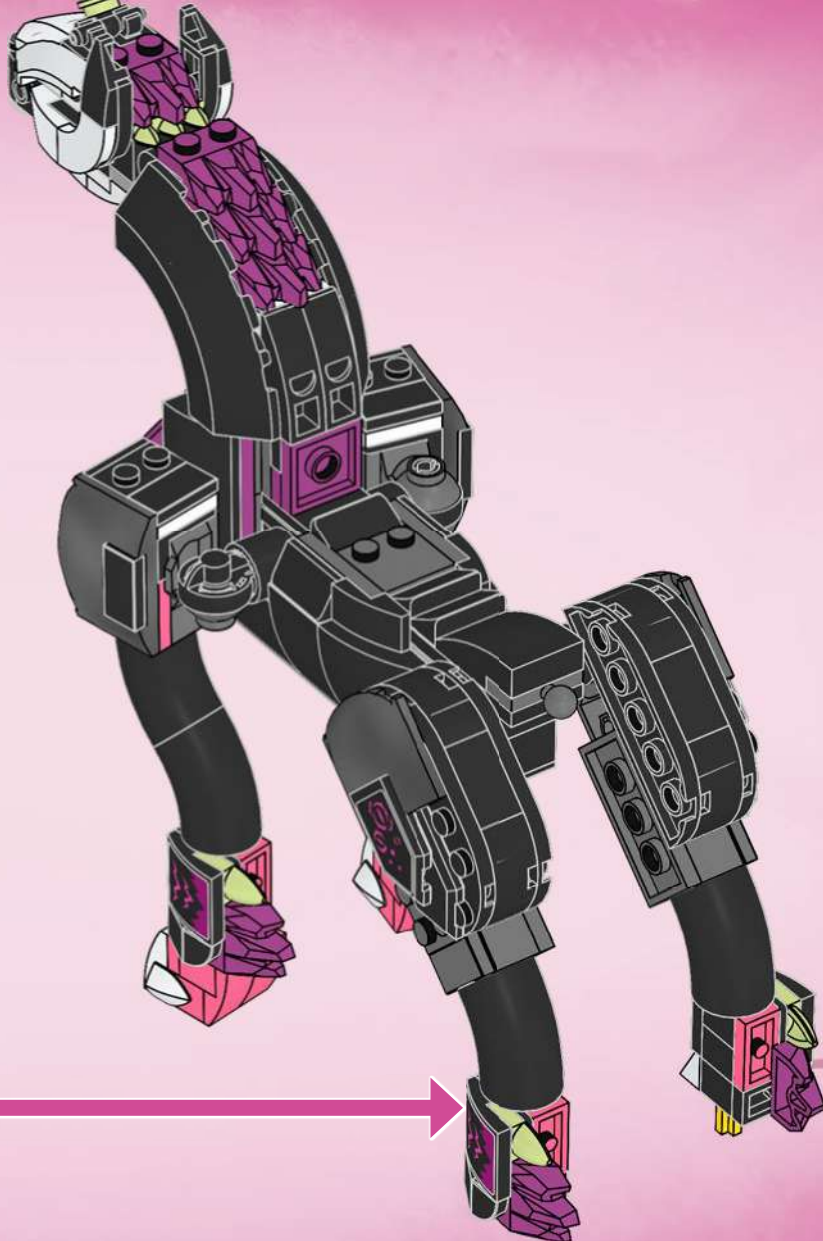



2x



2x



4x



2x



4x



4x

135

1



2



3



4

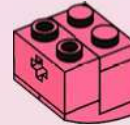

5



6



2x

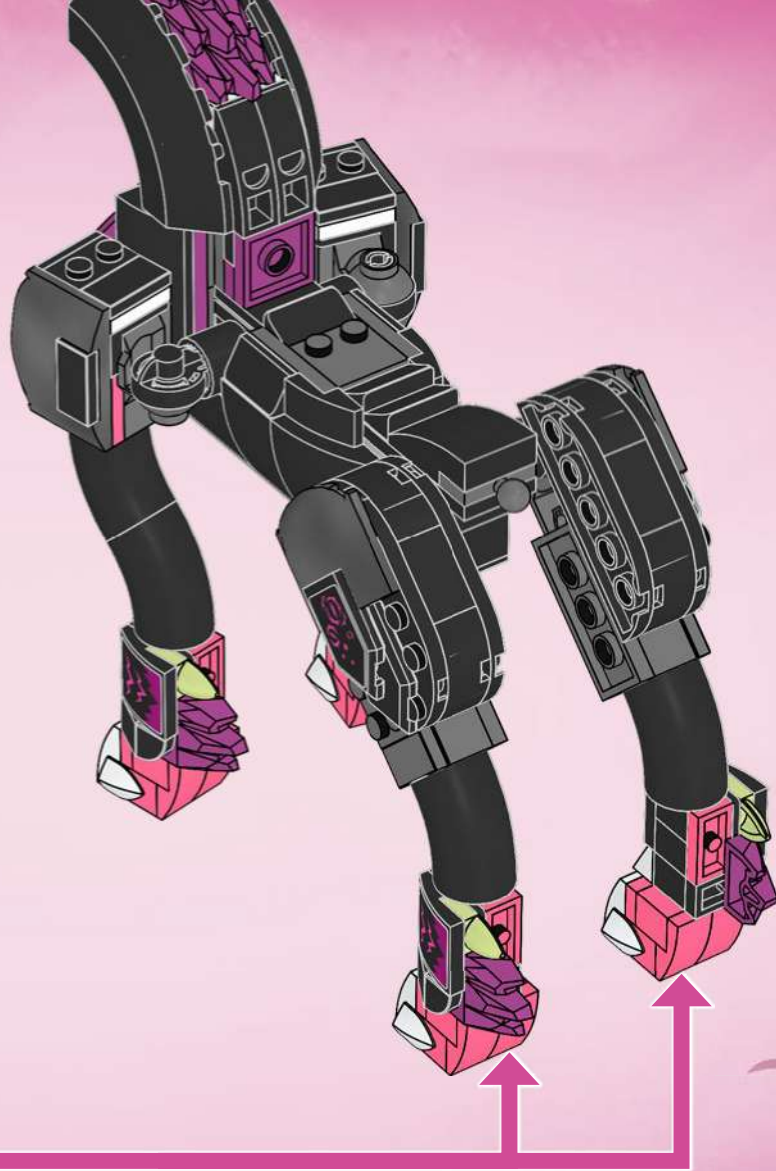



1x

136



2x

137



1x

138



1x

139





1x

140



2x

141

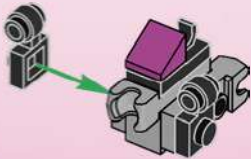

2x

142

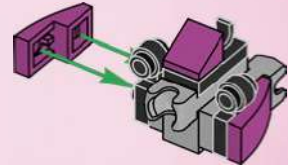

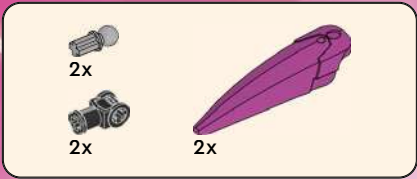

143

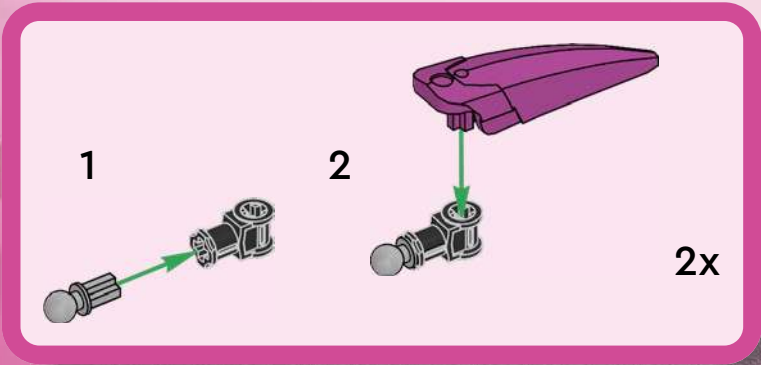
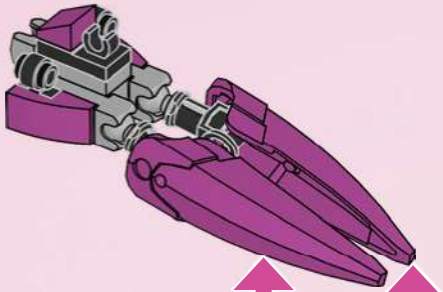

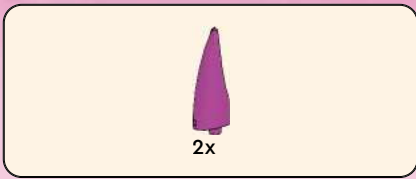

144

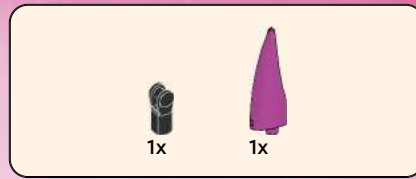
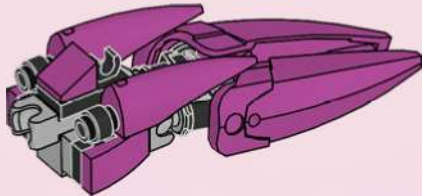

145

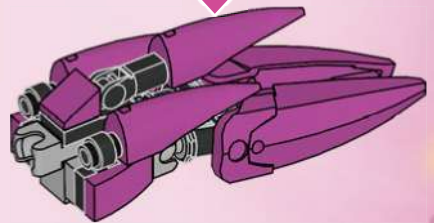
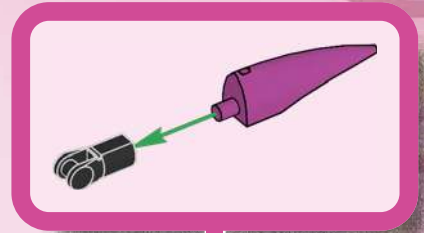

146

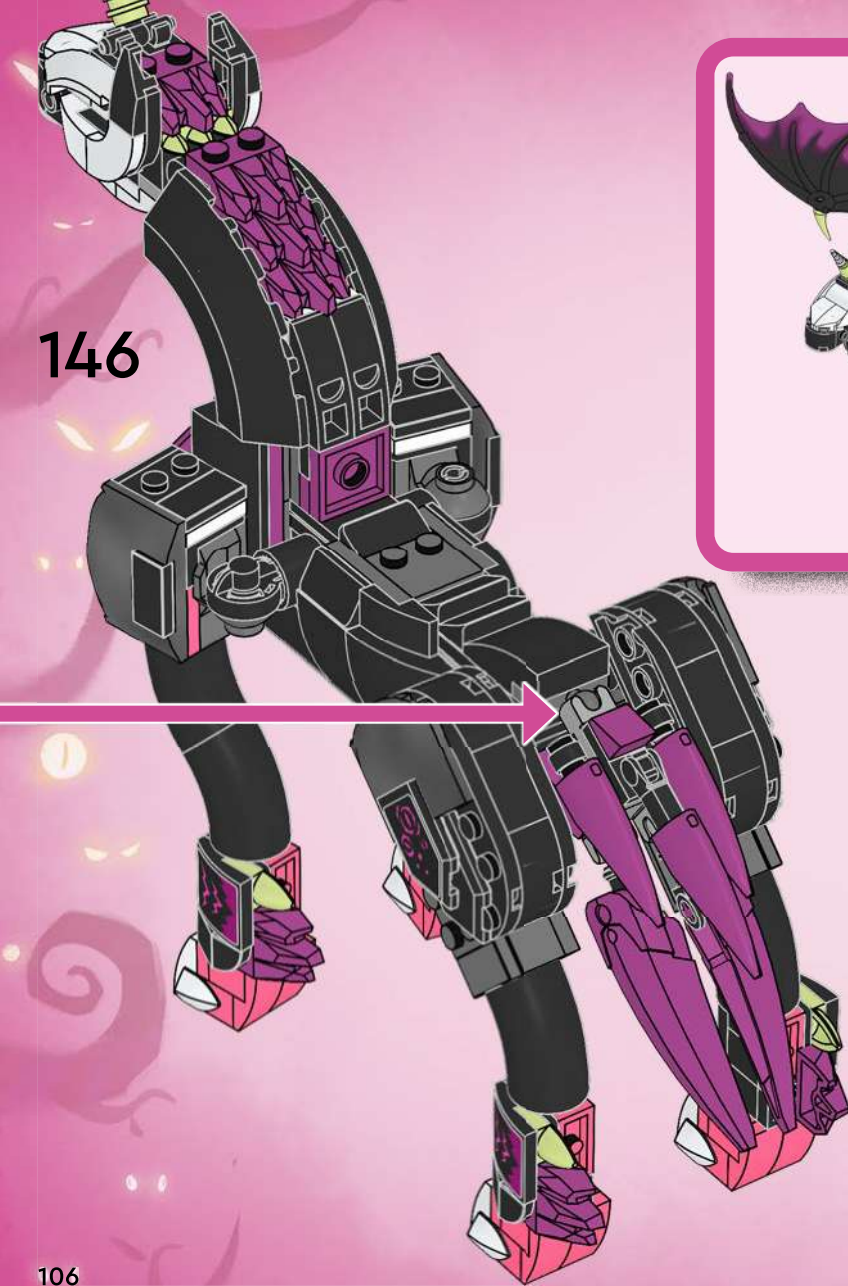





1

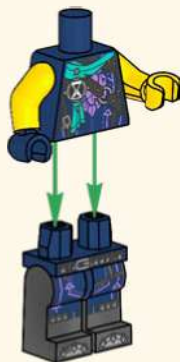

2



3



4

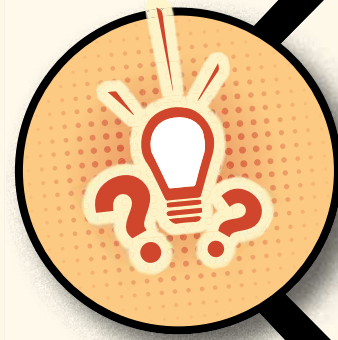





1x



1x

1

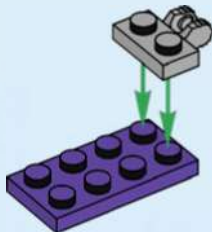



1x



1x

2

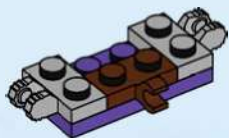

1x



2x

3

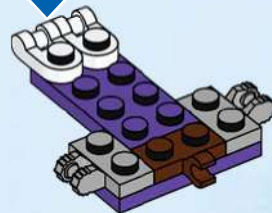
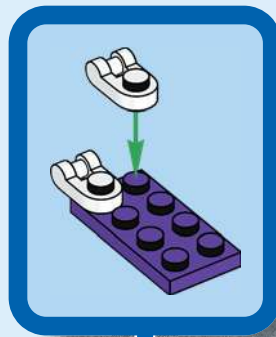



1x



1x

4

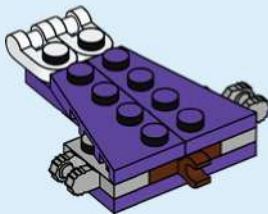



1x



2x

5

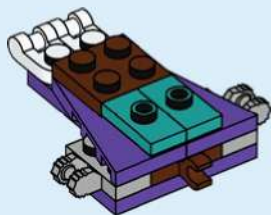

1x

6

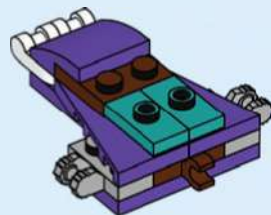



1x

7

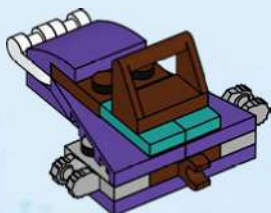

2x



2x

8

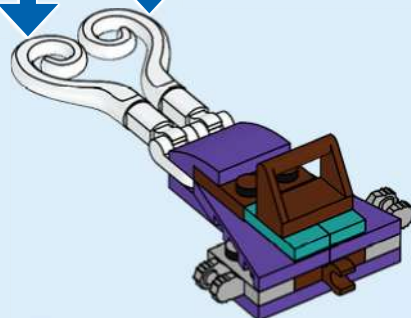
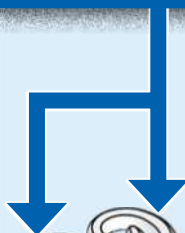
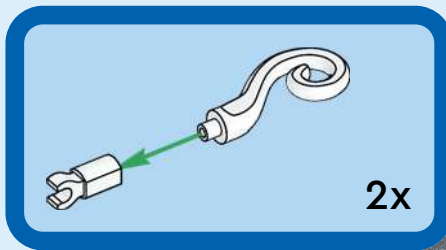



9



10

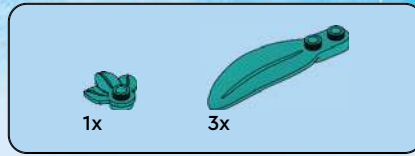

11

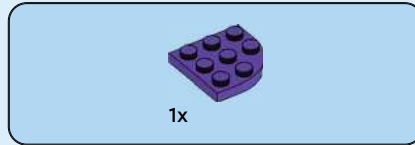

12



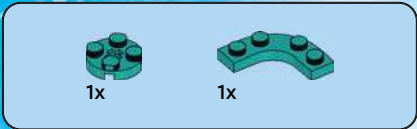

13

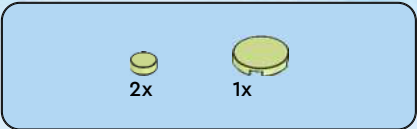
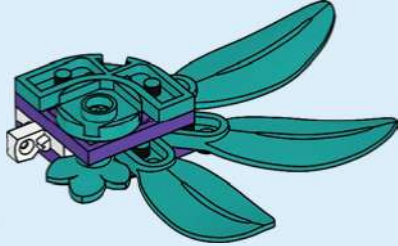

14

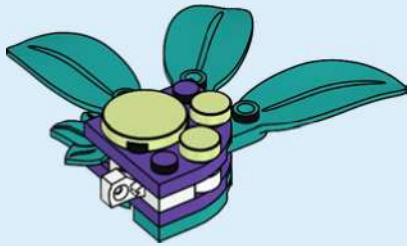

15

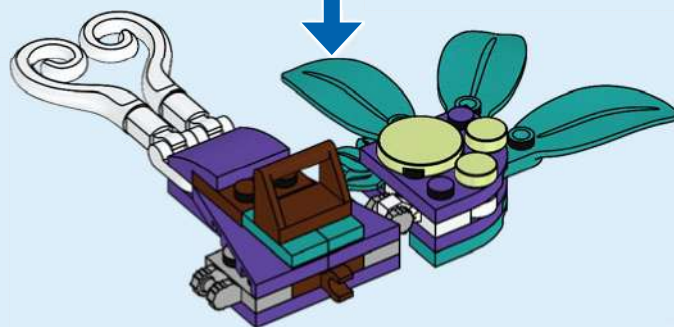

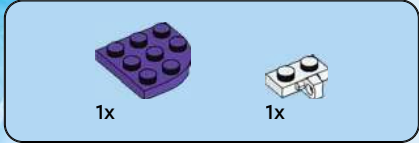
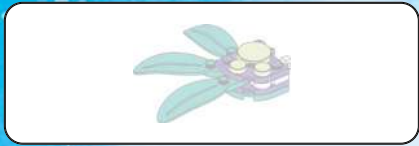

16



17

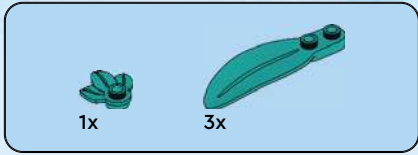

18

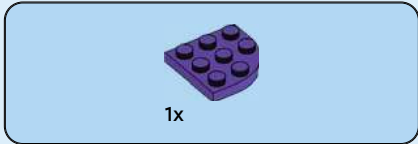
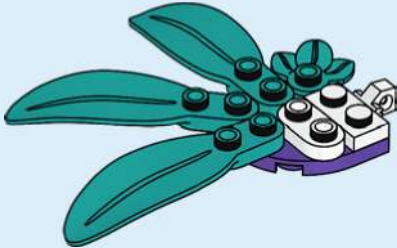

19

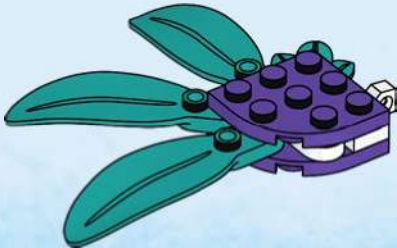



1x



1x

20

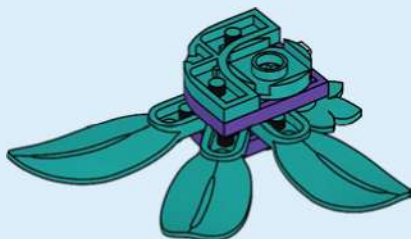

2x



1x

21

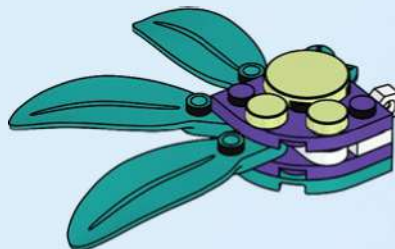

22

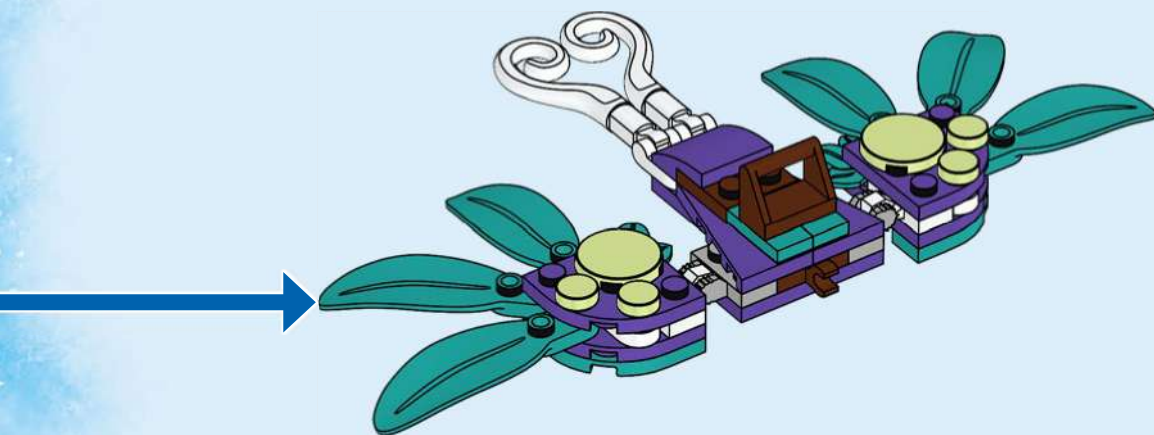

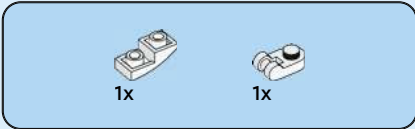

23

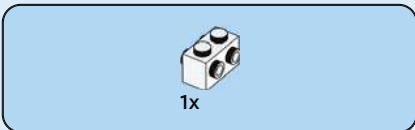
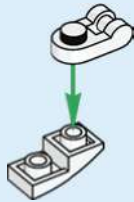

24



25

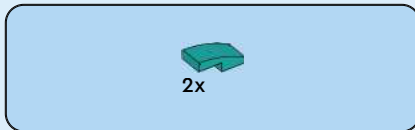
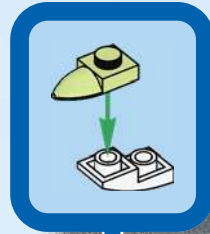

26

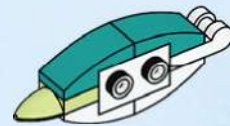



1x

27

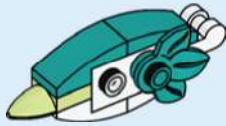

1x

28

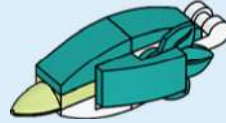

29

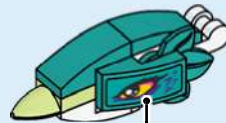



1x

30

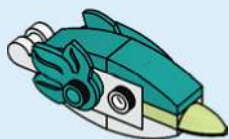
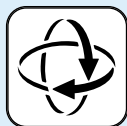

1x

31



32



33

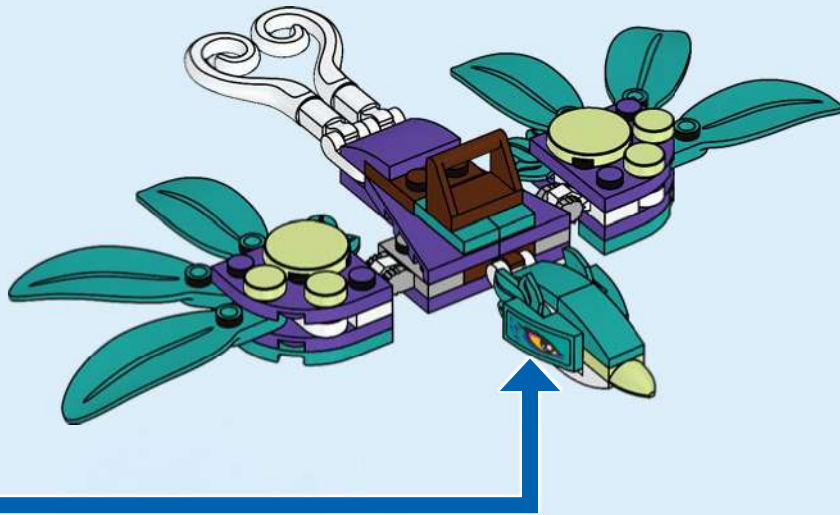



Swoosh

HEHE!!

FLAP

BYE!

FLAP

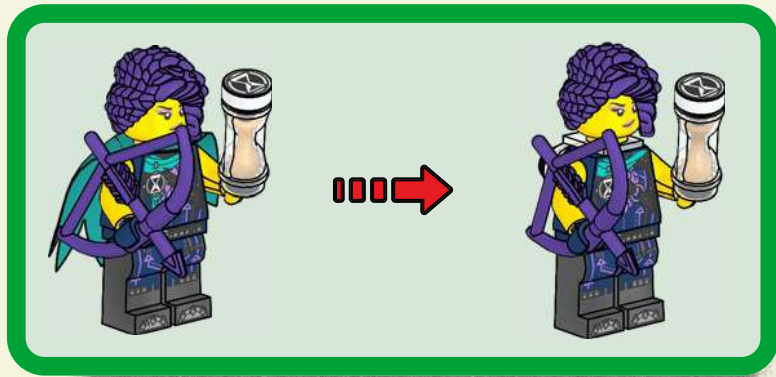

1



2

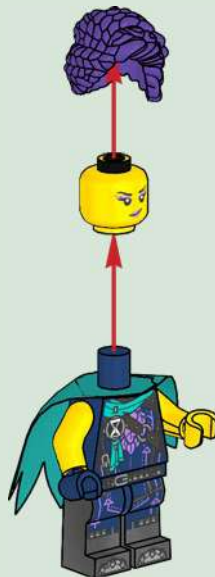

3



1

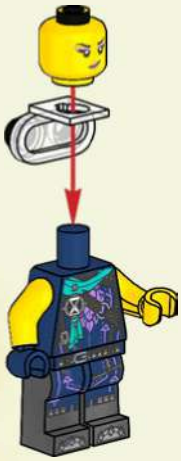

2



3



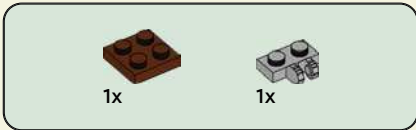
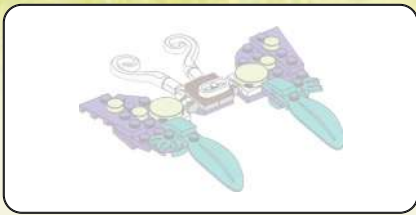

1x

1x

1



1x

2





2x

3



1x

4





5



6

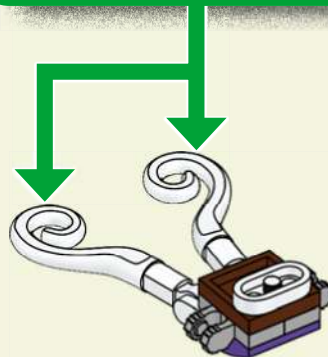
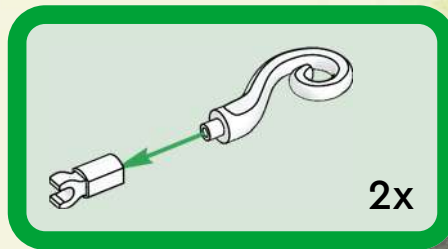

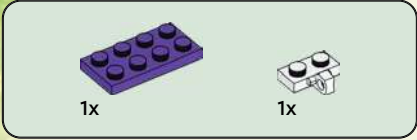

7

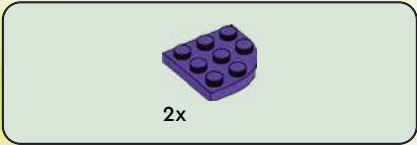
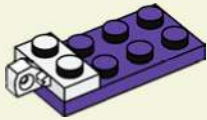

8

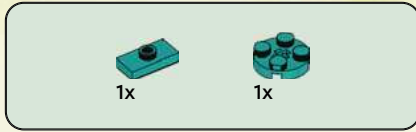

9

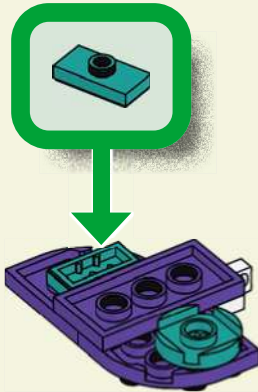

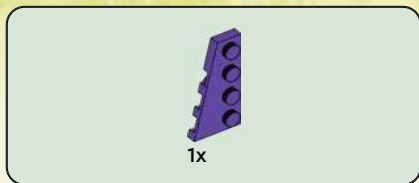

10

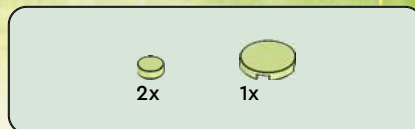

11

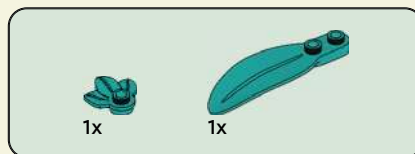
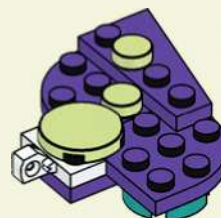

12

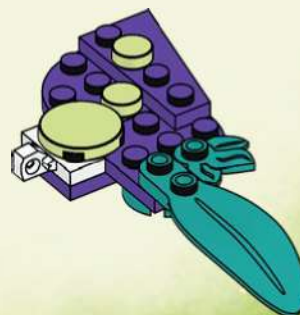



1x

13

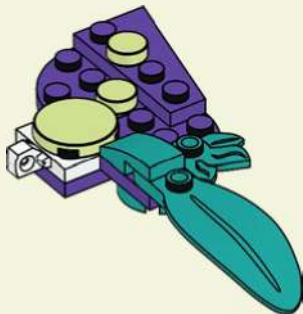

14

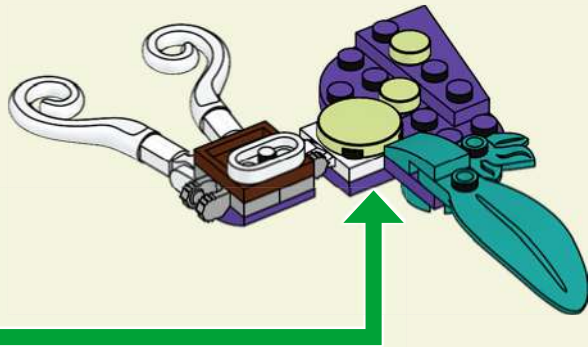

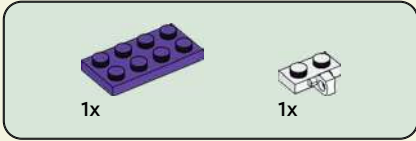
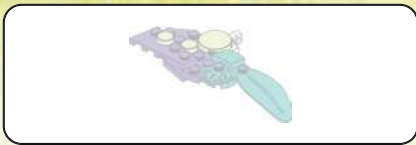

15

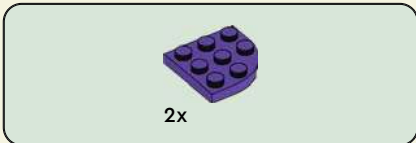
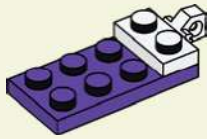

16



17

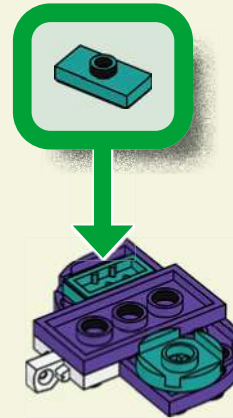
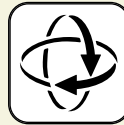

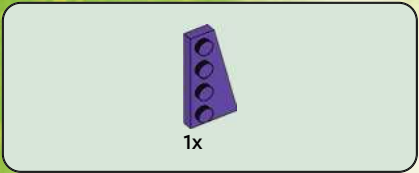

18

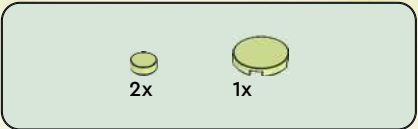
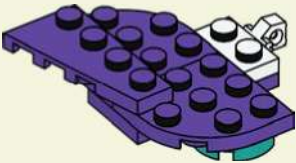

19

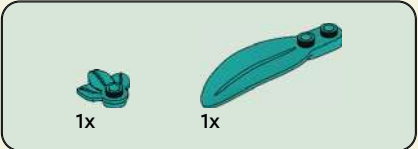
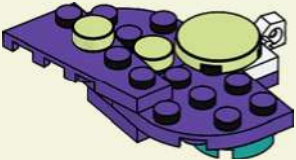

20

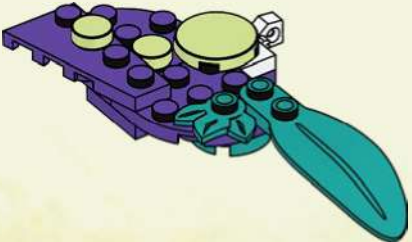



1x

21

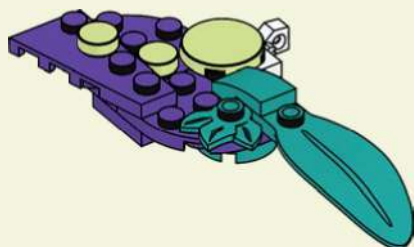

22

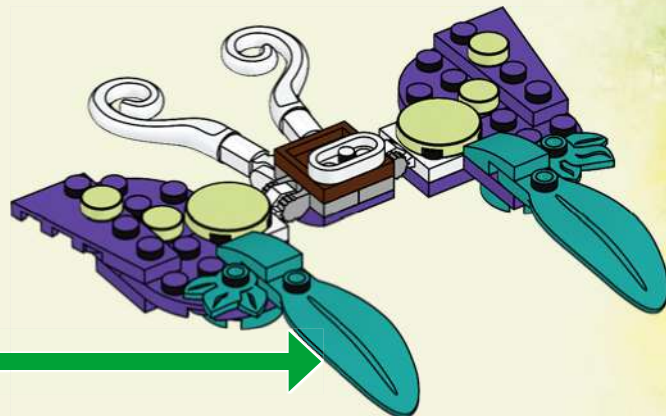



FIAP FLAP



SWOOM



HA!
HA!



OH!!





DREAMZZZ





71456



71457



71458



71461



71469



Watch series online
Schau dir die Serie online an
Regarde la série en ligne
Guarda la serie online
Mira la serie en Internet
Assistir à série online
在线观看剧

Oglądaj serial w internecie
Sleduj seriál online
Pozri si seriál online
Nézd a sorozatot online
Vizionează serialul online
Глядите сериала онлайн
Skaties seriālu tiešsaistē
Vaata sarja veebist
Žiūrėk serialą internetu



DREAMZZZ

WATCH
SERIES
ONLINE 



 [LEGO.com/DREAMzzz](https://www.lego.com/DREAMzzz)



Rebuild
the
world™



1x 6192793	1x 4667575	4x 6214334	1x 6321194	1x 6181713	1x 6000650		2x 6296186
2x 6341465	2x 6266253	2x 4142865	1x 6434239	8x 4548180	10x 6117973	2x 6439516	4x 6105963
4x 6322489	2x 6172927	3x 370021	1x 6435603	2x 6434233	2x 6310268	6x 6305216	1x 379526
1x 6434196	3x 6058177	2x 6129995	4x 6335388	7x 6279875	1x 6284188	5x 6116604	1x 303426
1x 6434236	2x 302301	1x 9341	2x 6273589	1x 4278359	1x 6195325	3x 6147790	1x 303426
4x 4504369	1x 6248827	1x 300423	12x 6344819	1x 6195325	4x 4213374	1x 6446694	2x 4514845
2x 6434241	1x 6442905	2x 6299413	4x 6172383	4x 6281993	1x 306826	4x 6039869	1x 4119479
2x 6213880	1x 4222017	1x 6434207	4x 4504382	1x 6434238	8x 6053077	4x 6039869	1x 6440804
8x 6046905	9x 302201	1x 6434234	1x 6181720	2x 6331716	4x 4567436	2x 6039869	2x 6166106
2x 6430887	5x 6047220	1x 6434228	2x 6187572	2x 6349281	5x 6089119	2x 6360825	1x 6430889
2x 6210272	2x 6210385	4x 302324	4x 6335317	10x 6276867	2x 6385597	2x 6325190	4x 6207783
3x 6174937	2x 6172674	1x 6310247	1x 6434240	3x 300426	4x 6245251	4x 4587844	1x 6424015
2x 6213881	1x 6135186	1x 300324	1x 6104209	2x 6047276	1x 6448722	1x 302026	1x 6240515
2x 403201	4x 6110023	4x 6130008	1x 6308032	1x 6347310	2x 6154860	1x 300126	1x 6240515

4

5

4x
6270179

2x
6210400

2x
6210399

4x
6249427

2x
6323161

1x
6435204

6x
6449584

2x
6328192

3x
6437507

1x
6177349

2x
6103415

1x
4611415

2x
6070763

8x
6439446

3x
6109930

2x
6329357

1x
6360042

4x
6037658

2x
6439445

1x
6186656



2x
6433445

1x
6434230

1x
6447374

5x
6275487

4x
6284598

1x
6256092

1x
6420918

8x
6267417

5x
6267420

2x
6424480

1x
6267421

1x
6448730

1x
6313124

1x
4211219

1x
4216695

1x
4211753

2x
6443149

2x
6372076

1x
4657459

2x
6266209

1x
6043656

1x
6258820

3x
6043639

1x
6469440

1x
6448731

1x
6361354

4x
6258098

8x
6439447

10x
6258094

8x
6438408

2x
6371787

1x
6430879

1x
6211334

1x
6211336

1x
6451947

1x
6182217

4x
6251900

2x
6030277

2x
6197967

4x
6349622

3x
6336970

1x
4210633

2x
6318697

2x
6039479

8x
6178919

2x
4211052

4x
6308045

3x
6309059

2x
4289258

6x
4211043

4x
6343337

4x
4211065



[LEGO.com/service](https://www.LEGO.com/service)

YOU COULD **WIN**



Scan this QR code or go to **LEGO.COM/PRODUCTFEEDBACK** and give us your short feedback about this LEGO® set for a chance to win a cool LEGO prize.

Terms and Conditions apply*

EN: YOU COULD WIN. Terms and Conditions apply* **DE: Du könntest GEWINNEN.** Es gelten die Teilnahmebedingungen* **FR: Tu pourrais GAGNER.** Des conditions s'appliquent* **IT: Potresti VINCERE tu.** Termini e condizioni sono applicabili* **ES: Puedes GANAR.** Aplican términos y condiciones* **PT: Poderá GANHAR.** Aplicam-se termos e condições* **ZH: 轻松获奖. 条款和条件适用*** **PL: Szansa na WYGRANĄ.** Obowiązują warunki korzystania* **CS: Máte šanci VYHRÁT.** Platí všeobecné smluvní podmínky* **SK: Máte šancu VYHRAŤ.** Platia všeobecné zmluvné podmienky* **HU: TE IS NYERHETSZ.** Felhasználási feltételek érvényesek* **RO: Ai putea CÂȘTIGA.** Se aplică termeni și condiții* **BG: Можете да СПЕЧЕЛИТЕ.** Има определени правила и условия* **LV: Tu vari LAIMĒT.** Ir spēkā noteikumi un nosacījumi.* **ET: Sul on võimalus VÕITA.** Kehtivad tingimused* **LT: Jūs galite LAIMĖTI.** Taikomos sąlygos*

*[LEGO.com/productfeedback-terms](https://www.lego.com/productfeedback-terms)