



SONIC™

THE HEDGEHOG

76991



1



 **FR**
DONNEZ
OU
RECYCLEZ

 OU  OU 

ASSOCIATION MAGASIN DÉCHÈTERIE

Adresses sur quefairedemesdechets.fr



LEGO.com/sustainable-packaging



BUILDER



Apple and the Apple logo are trademarks of Apple Inc., registered in the U.S. and other countries and regions. App Store is a service mark of Apple Inc. Google Play and the Google Play logo are trademarks of Google LLC. Tencent and the Tencent logo are trademarks of Tencent Inc.

Q [LEGO.com/devicecheck](https://www.lego.com/devicecheck)

EN Ask parents' permission before going online | **DE** Eltern um Erlaubnis bitten, bevor du online gehst | **FR** Demande l'autorisation d'un parent avant d'aller en ligne | **IT** Chiedi il permesso ai tuoi genitori prima di andare online | **ES** Pídeles permiso a tus papás antes de conectarte a Internet | **PT** Pede autorização aos pais antes de acederes online | **ZH** 上网前应先征得父母的同意 | **PL** Poproś rodziców o zgodę, zanim wejdiesz do Internetu | **CS** Než půjdeš na internet, požádej rodiče o svolení | **SK** Skôr než pôjdeš na internet, vypýtaj si povolenie od rodičov | **HU** Kérj szülői engedélyt, mielőtt online csatlakoznál! | **RO** Cere permisiunea părinților înainte de a te conecta online | **BG** Поискайте разрешение от родител, преди да влезете онлайн | **LV** Pirms došanās tiešsaistē palūdz atļauju vecākiem | **ET** Enne Interneti kasutamist küsi vanematelt luba | **LT** Prieš prisijungdami prie interneto, atsiklauskite tėvų

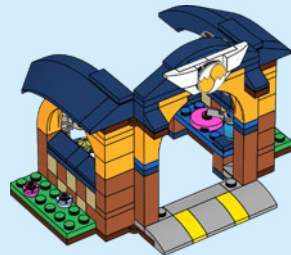
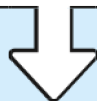
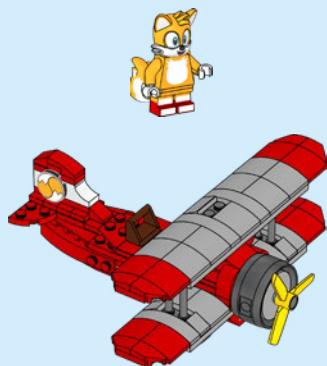
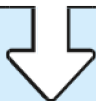
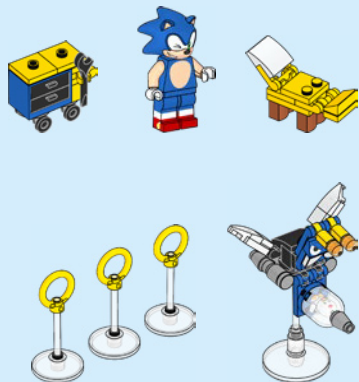
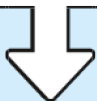

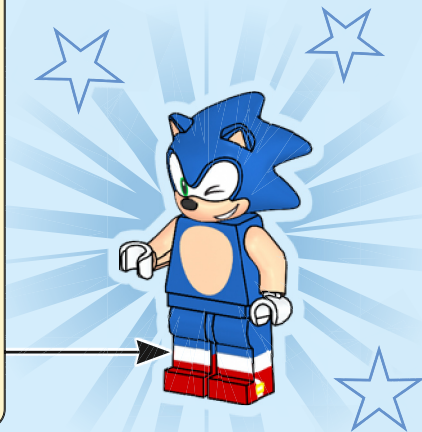
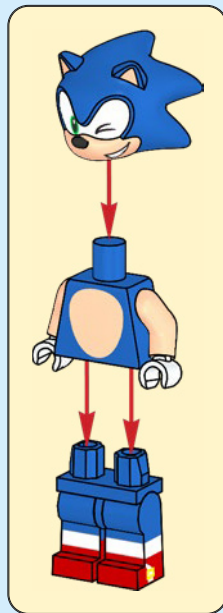

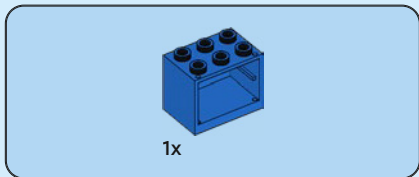

1

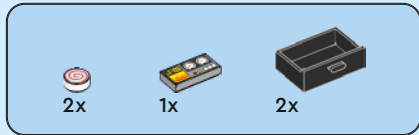
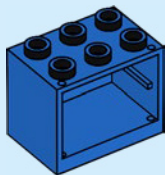

2

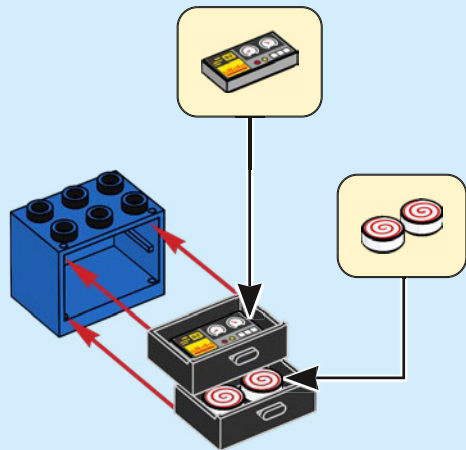



2x

3

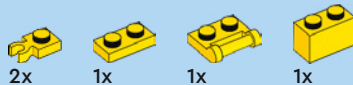
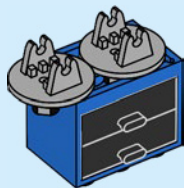

2x

1x

1x

1x

4

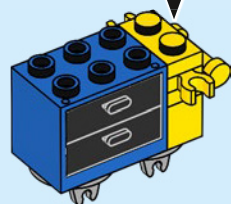
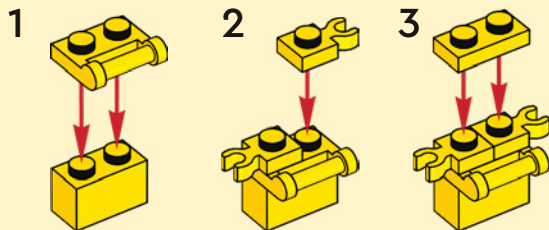



2x

5

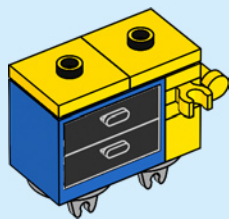

8





2x

6

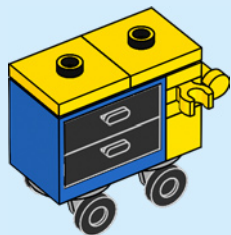

1x

7

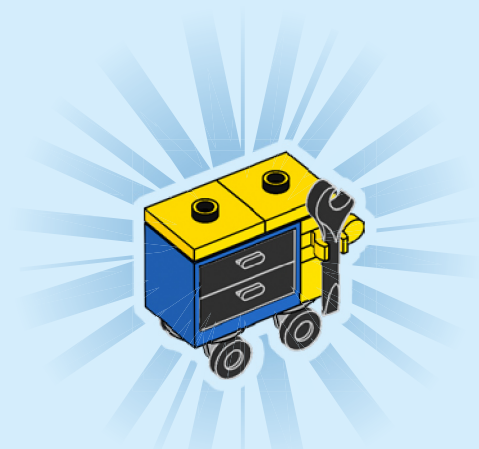

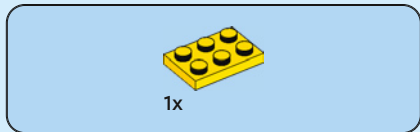
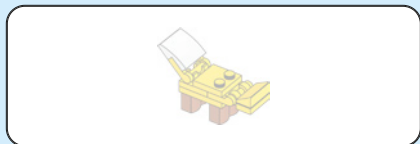

1



10

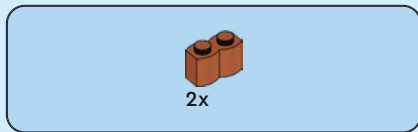

2

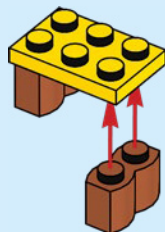



2x



1x

3

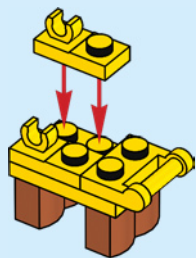

1x

4

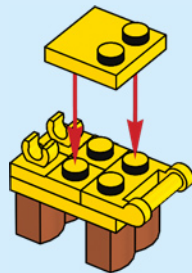



1x



1x

5

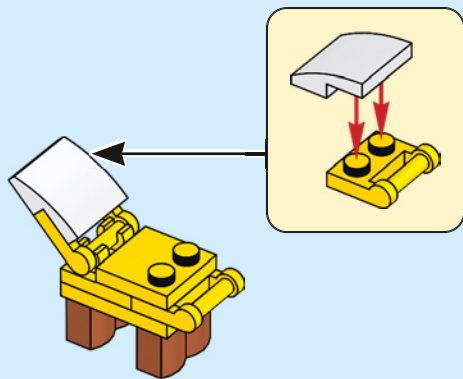

1x



1x

6

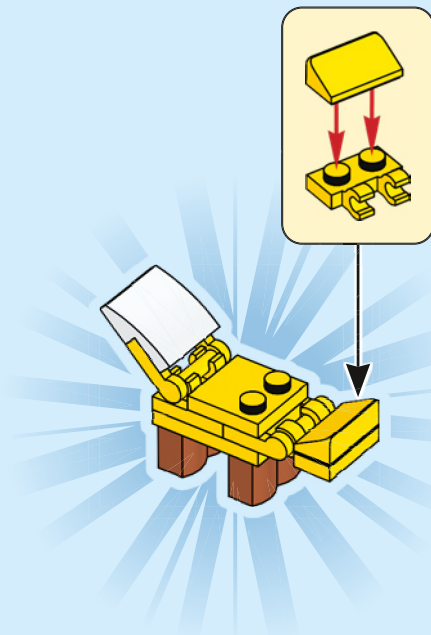

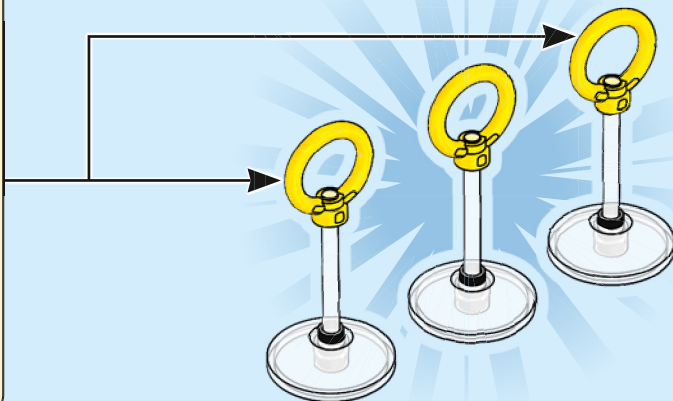
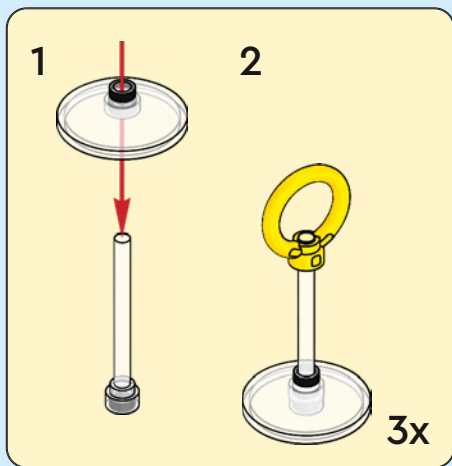
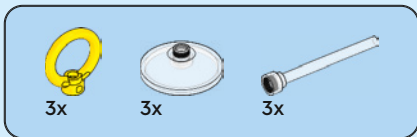

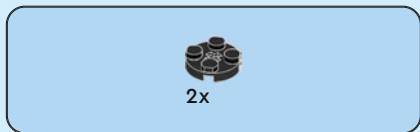

1

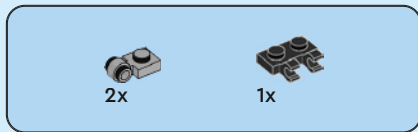
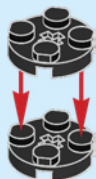

2

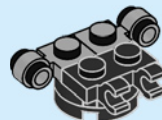



1x



1x

3

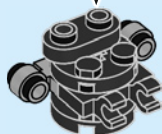
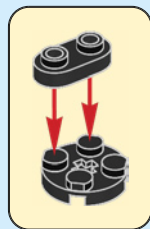

2x

4

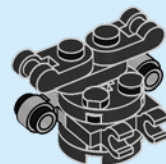



2x



1x

5

1

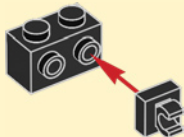

2

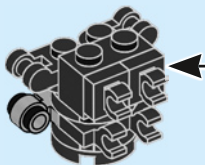
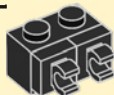

1x

6

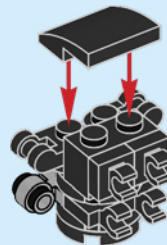



2x

7

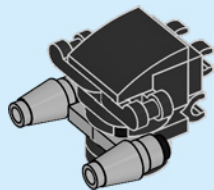

2x



2x

8

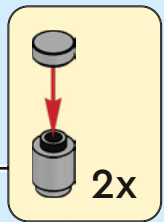
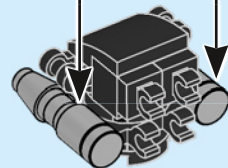

2x

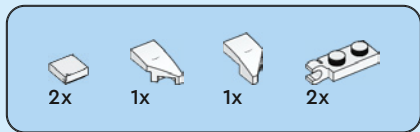

9

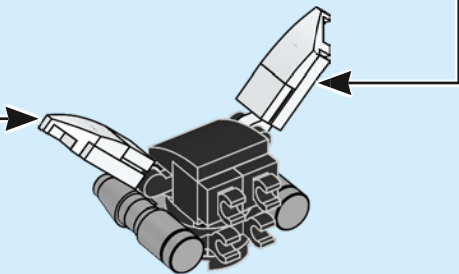
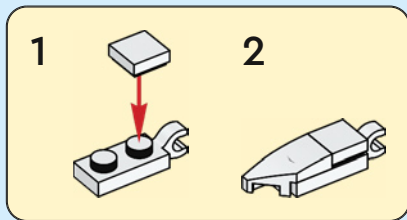
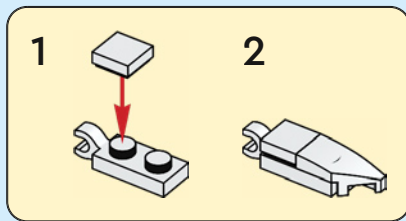

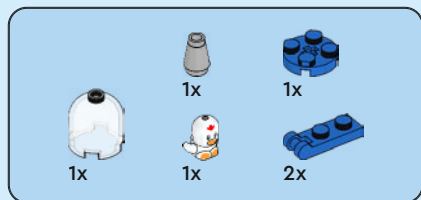

10

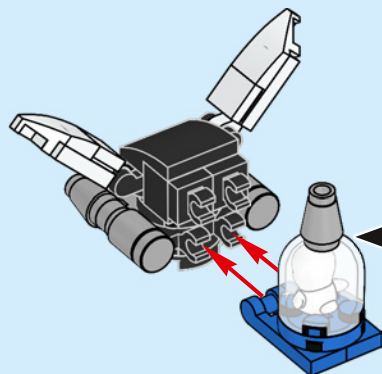
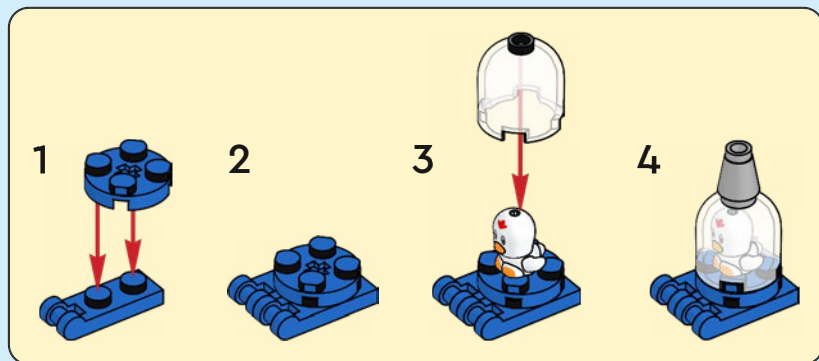



1x

11



2x

12

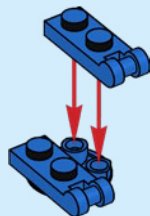



1x

13

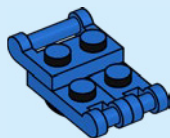

2x



1x

14





2x



2x

15

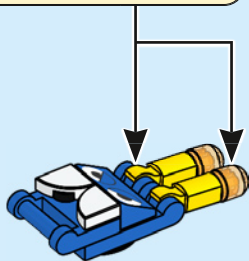
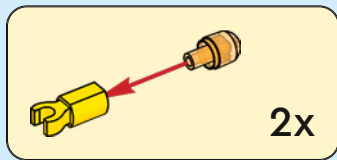

16

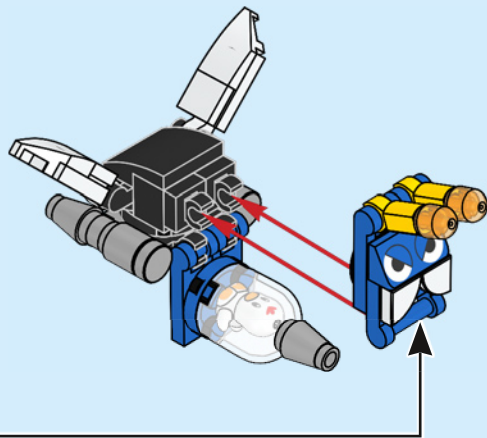

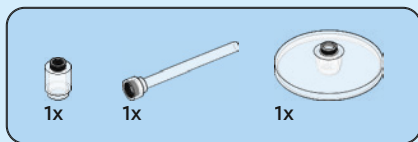

17

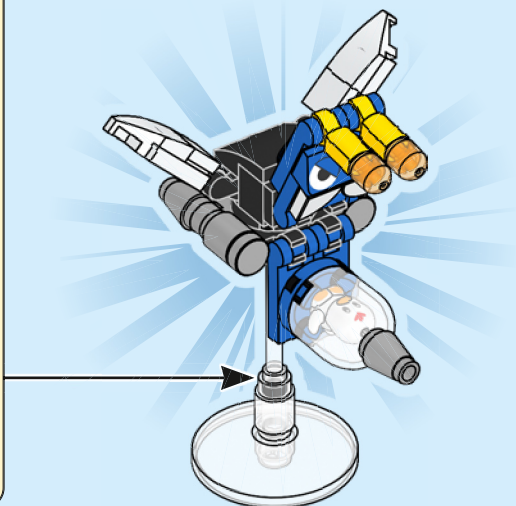
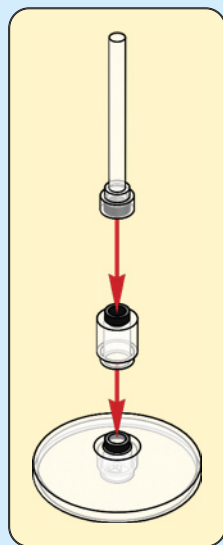



1

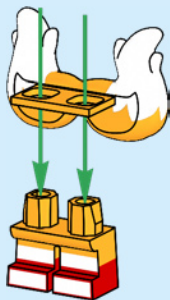

2

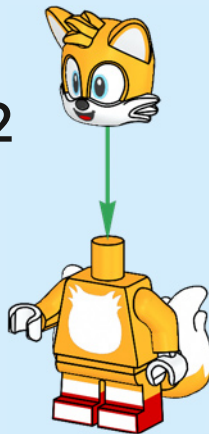

3



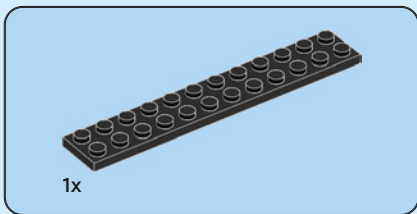
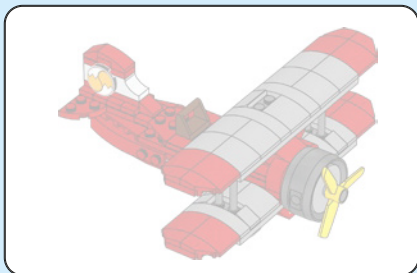

1

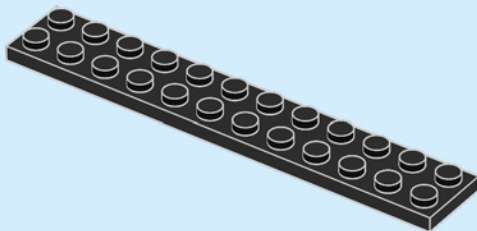

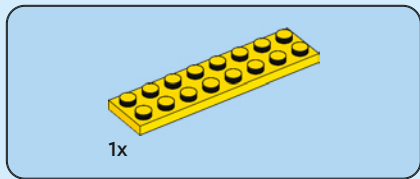

2

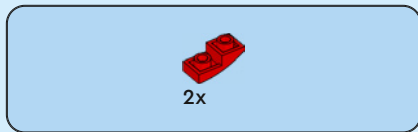
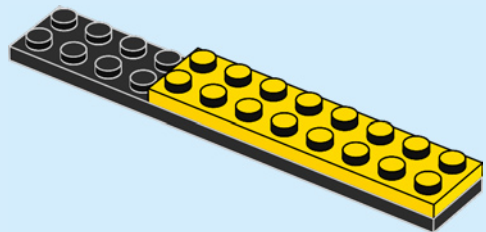

3

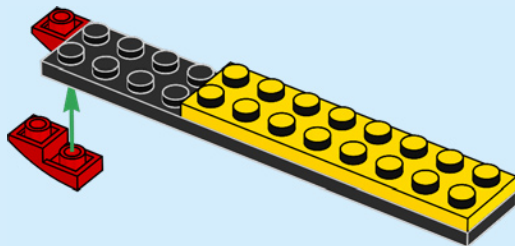



2x



1x

4

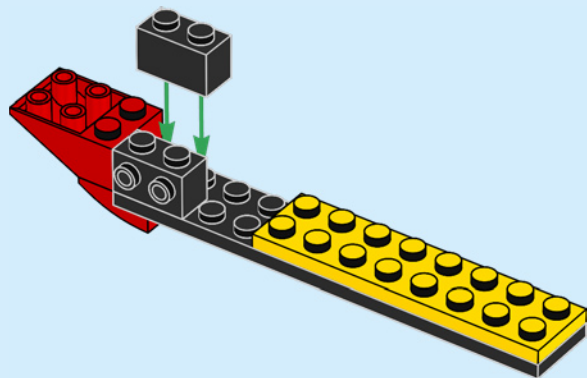

1x



2x

5

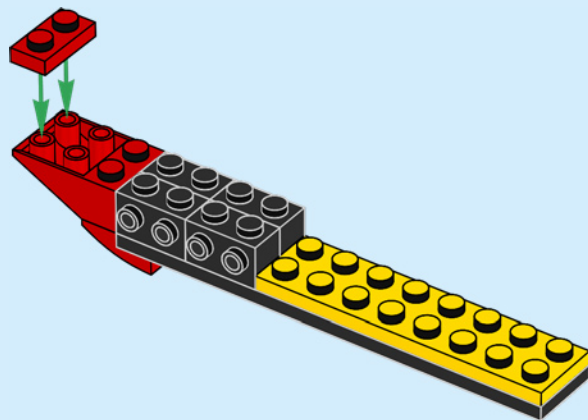

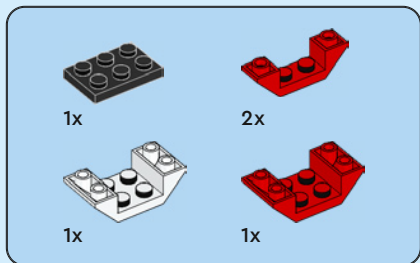

6

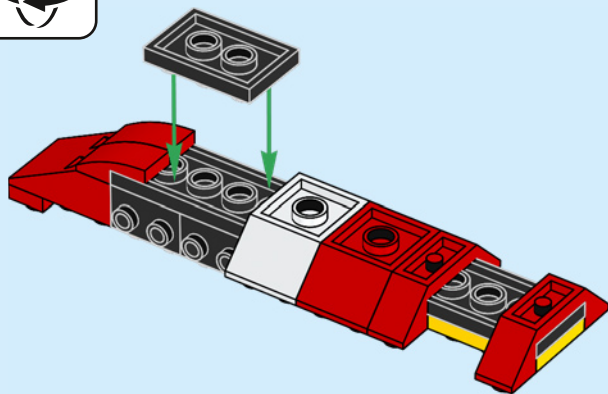

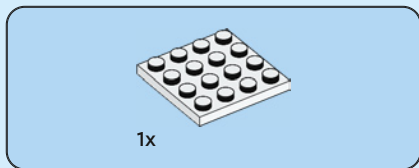

7

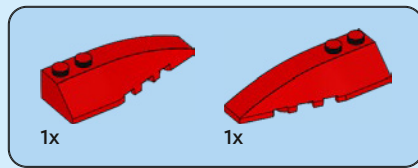
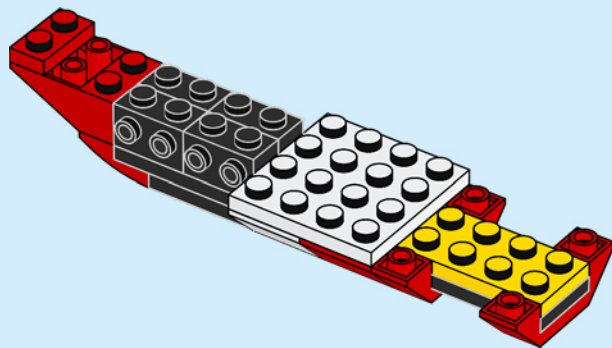

8

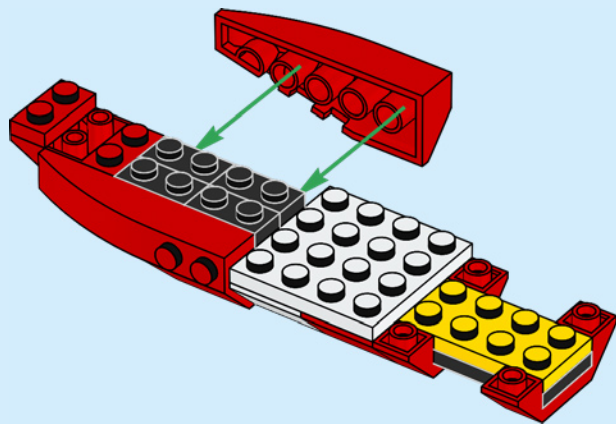

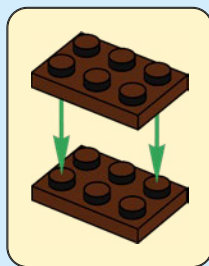
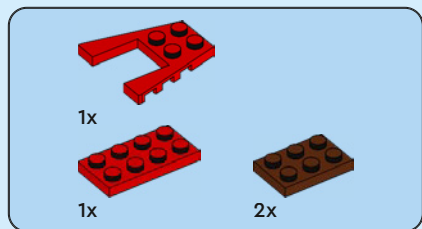

9

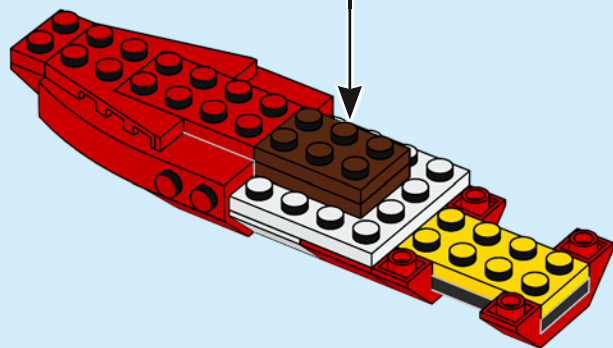

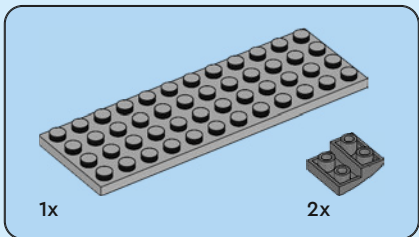
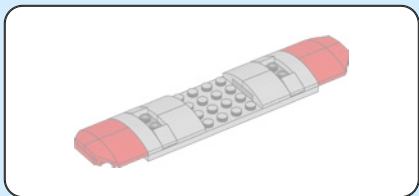

10

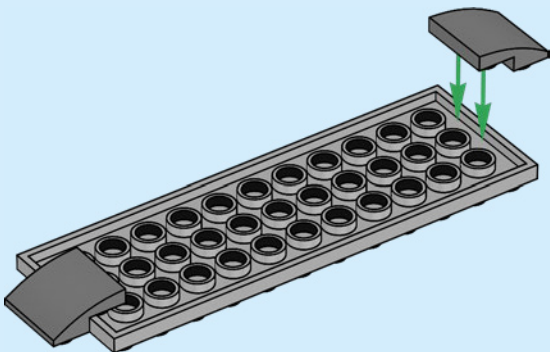



2x

11

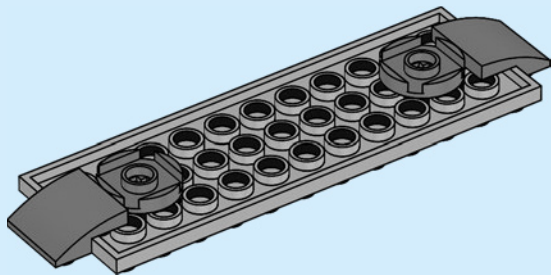

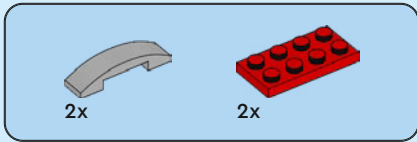

12

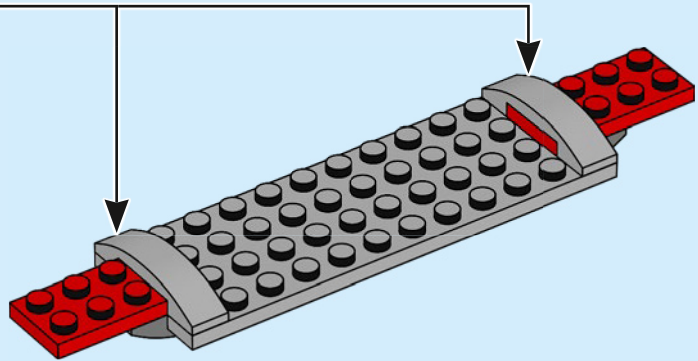
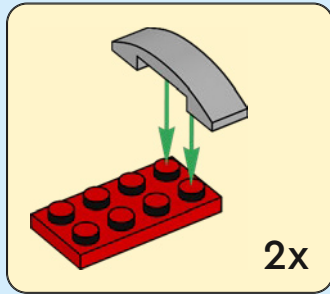



2x



2x



4x

13

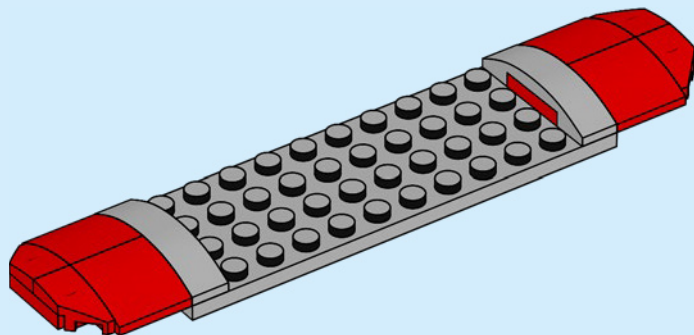



4x



2x

14

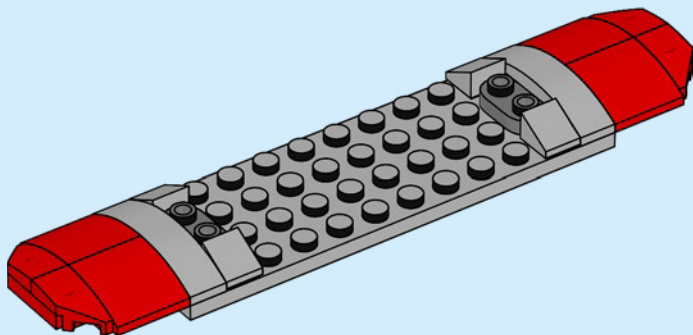



2x

15

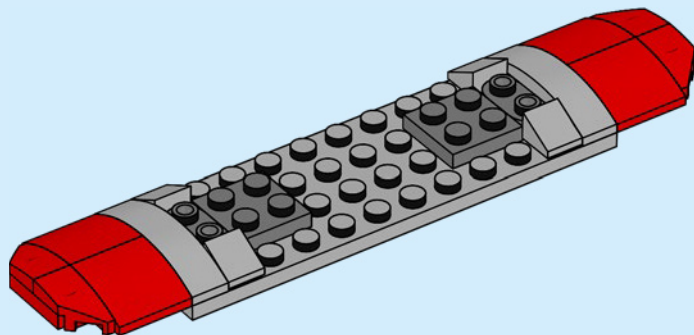



4x

16

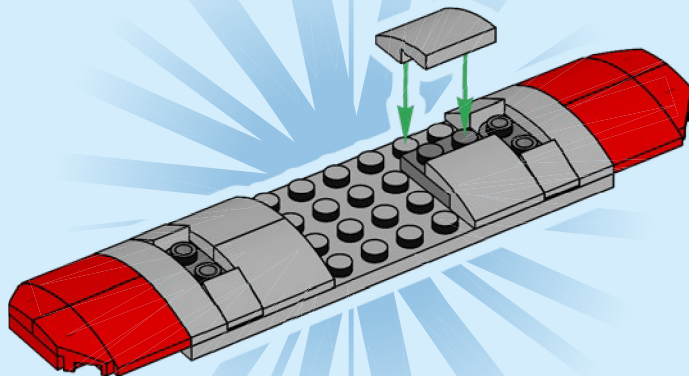

17

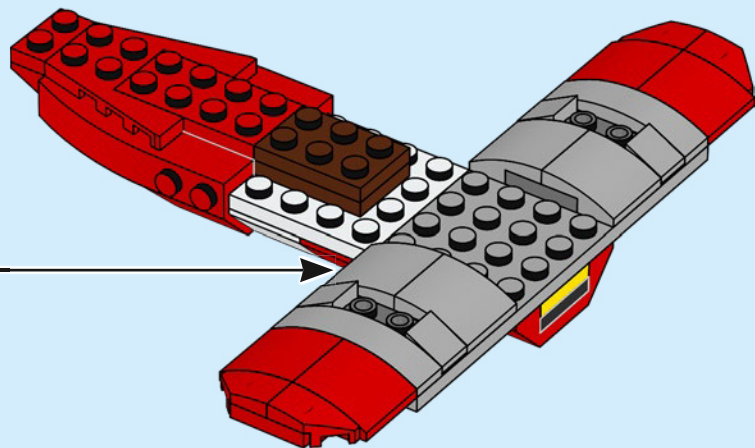

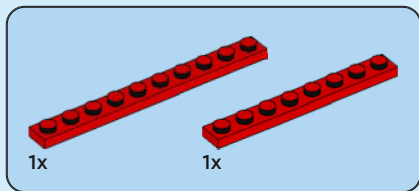

18

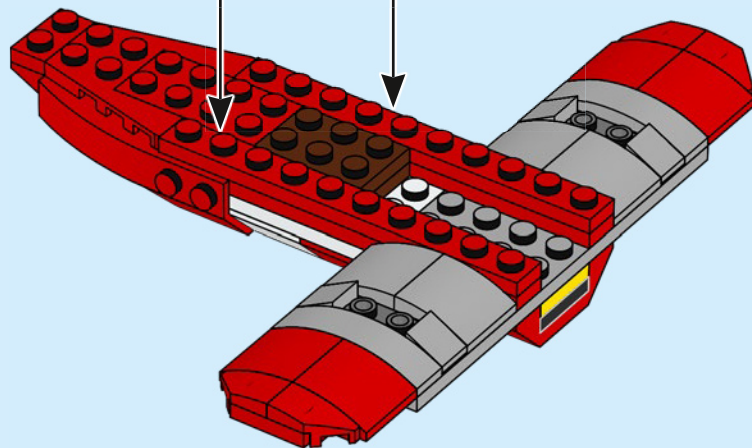
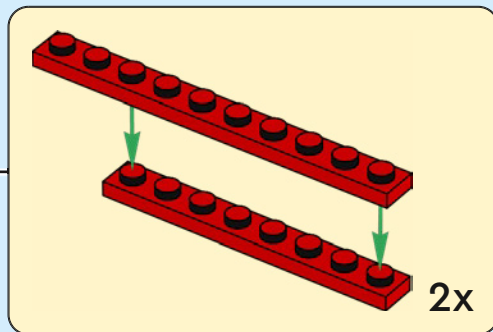

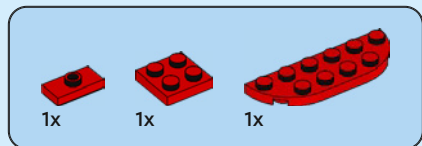

19

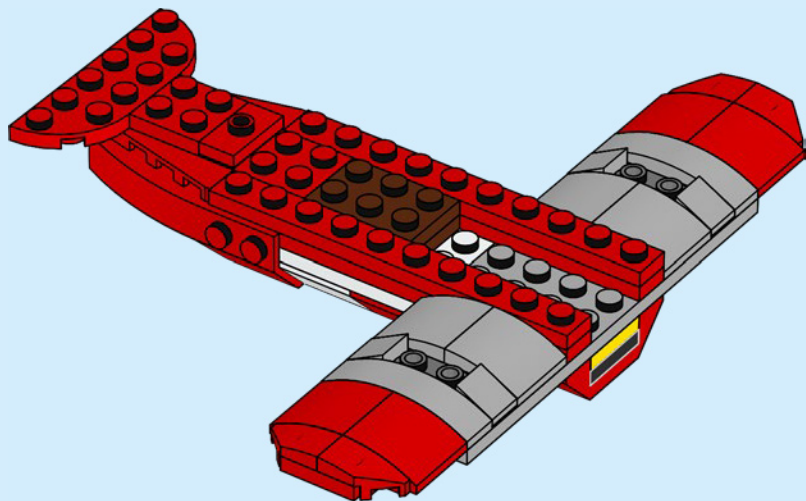



1x



1x

20

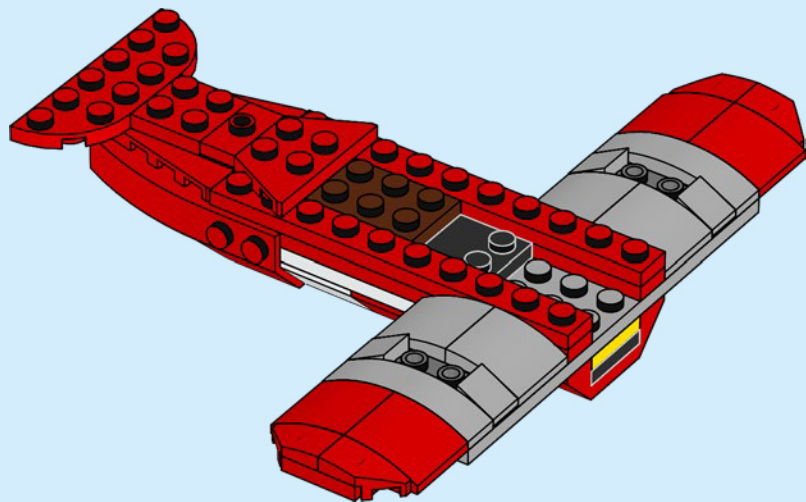

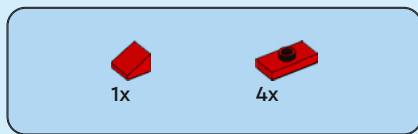

21

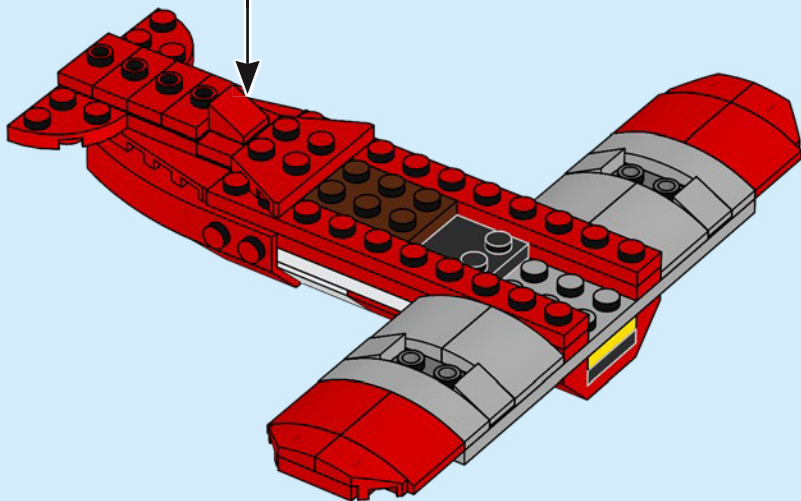
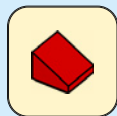



2x



1x

22

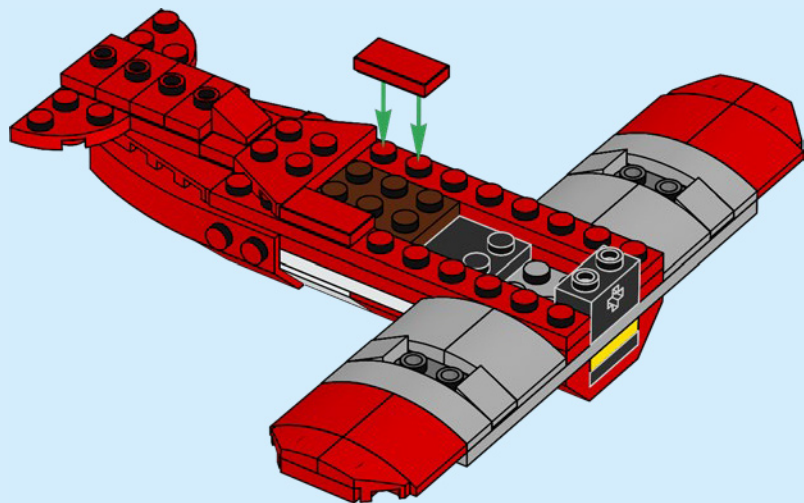



1x



2x

23

1



2

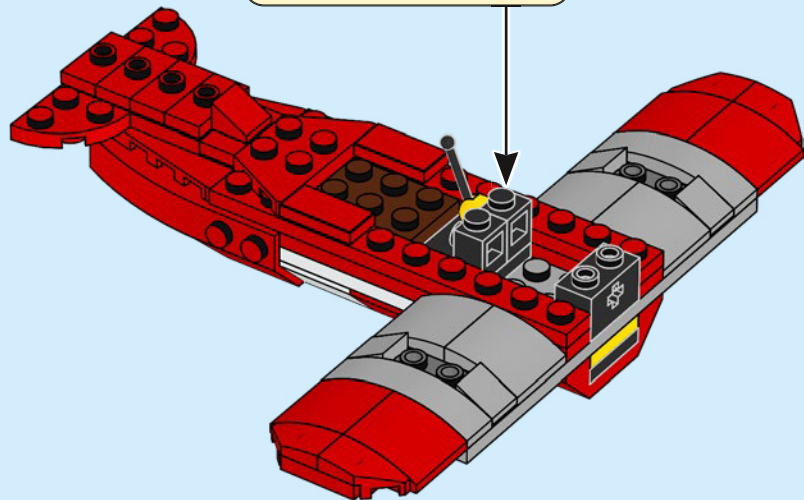

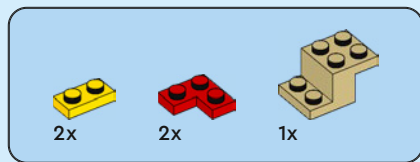

24

1

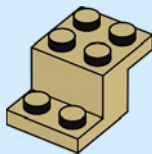

2

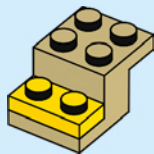

3

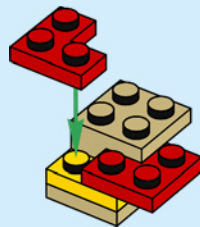

4

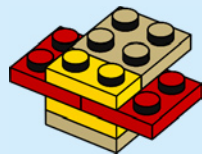

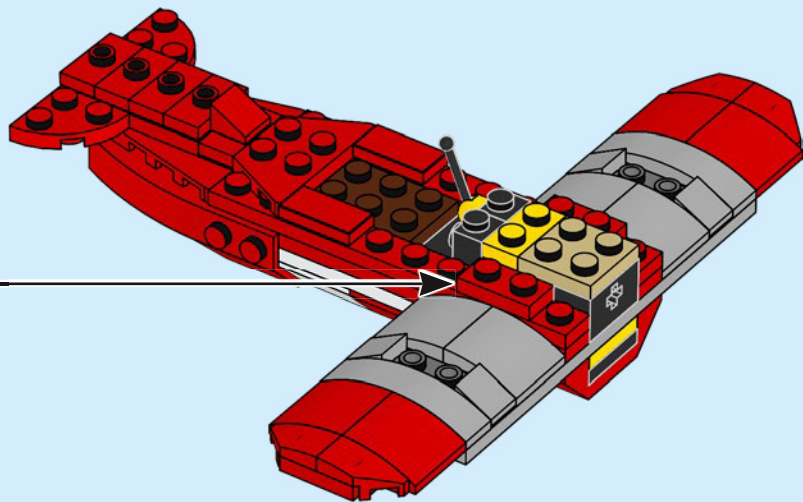



2x



1x

25

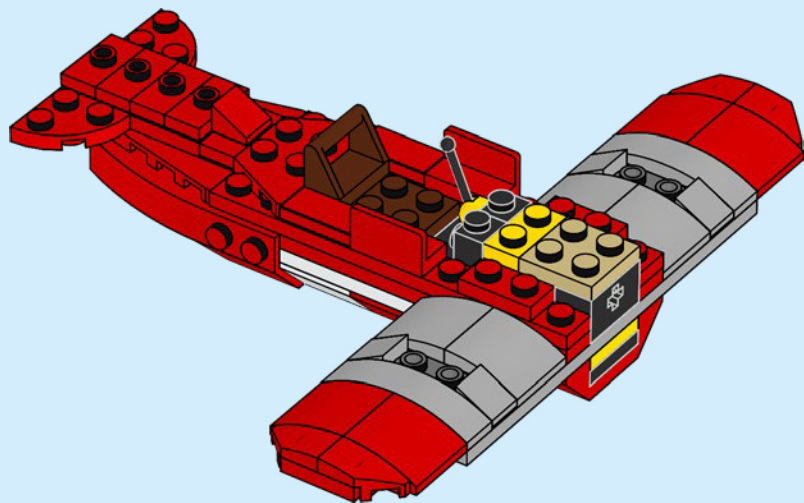



2x

26

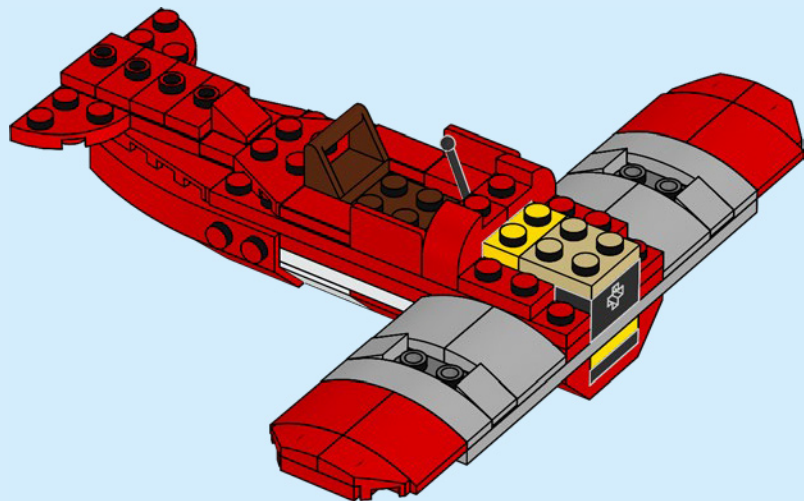



2x



2x

27

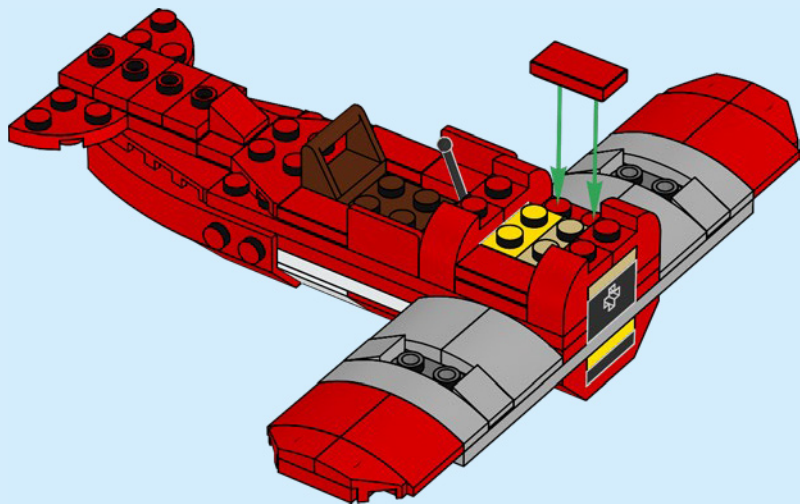

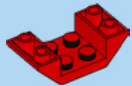

1x

28

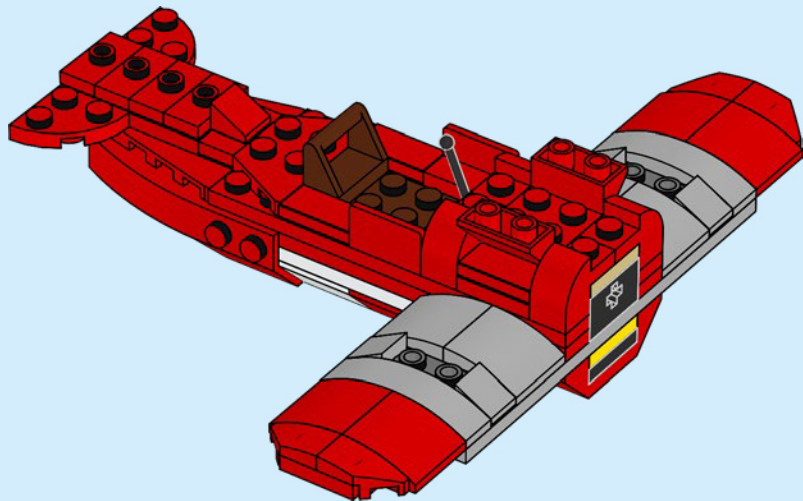



1x

29

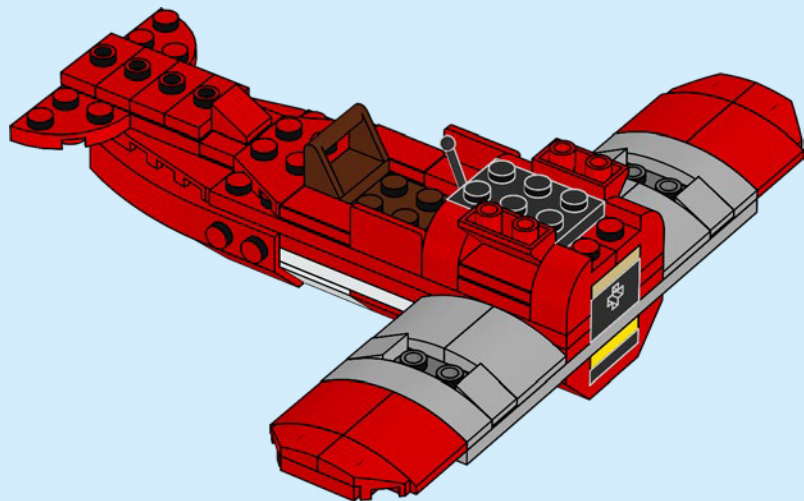



1x



1x



1x

30

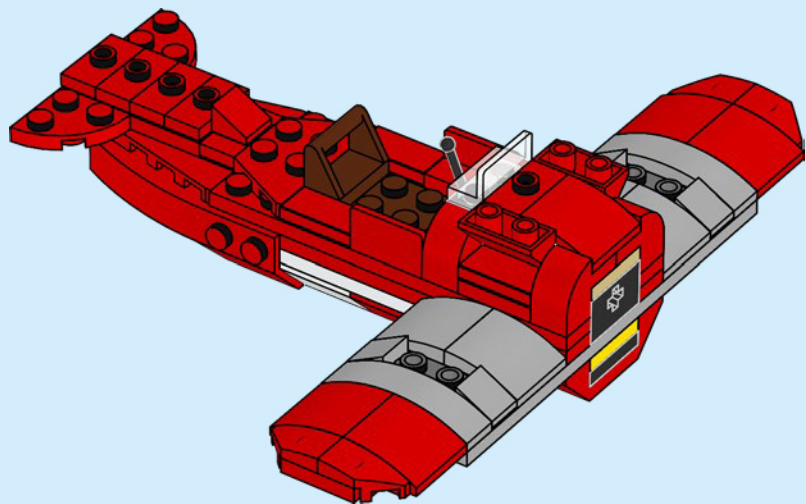



1x



1x

31

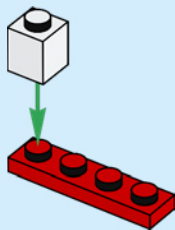



1x



1x

32

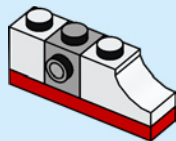

1x

33

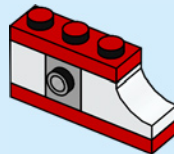



2x

34

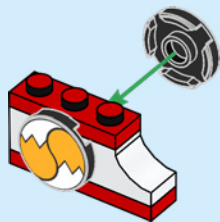

1x

35

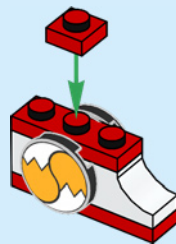



1x



1x

36



37

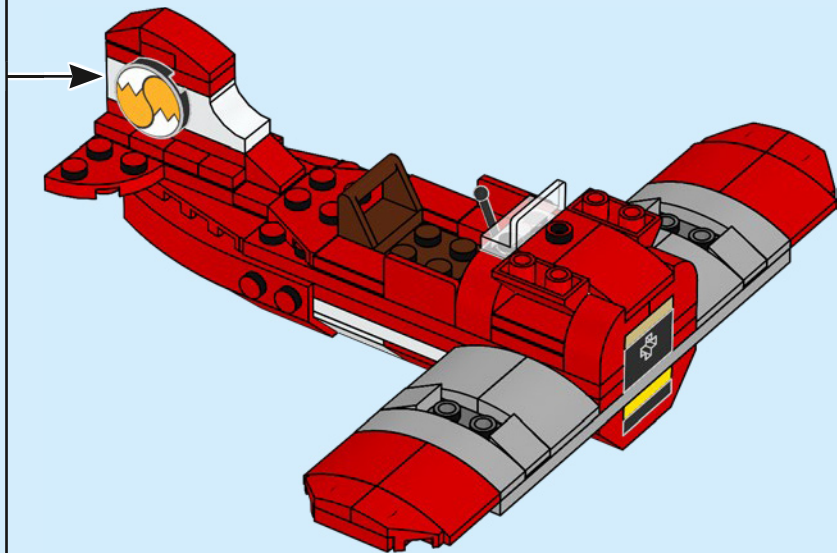



2x

38

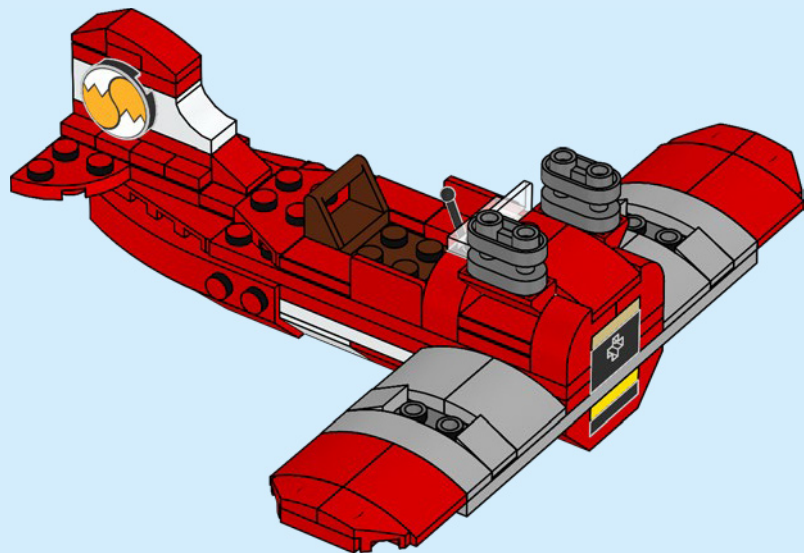

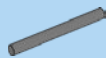

4x

39

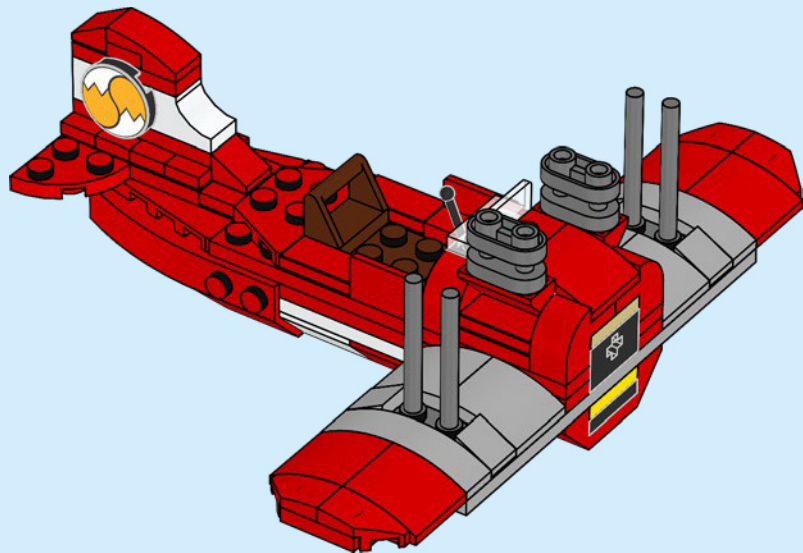

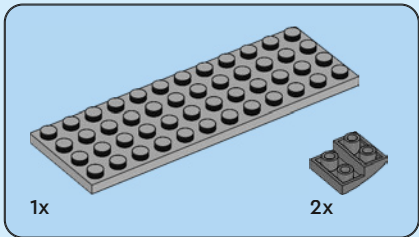
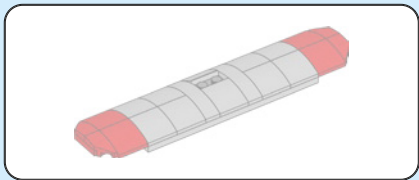

40

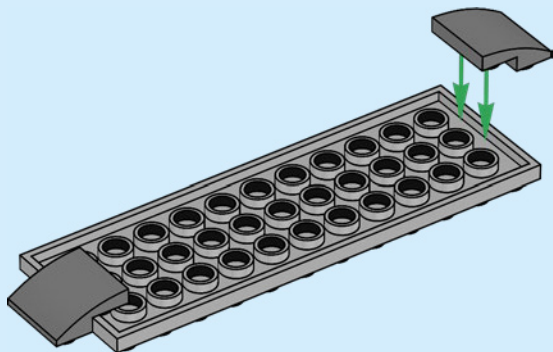



41

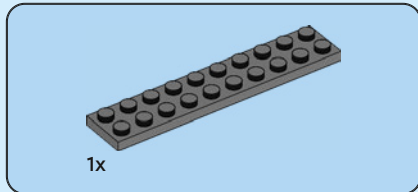
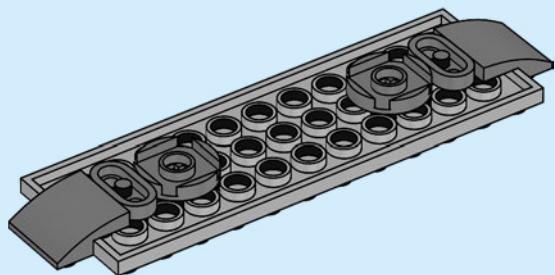

42

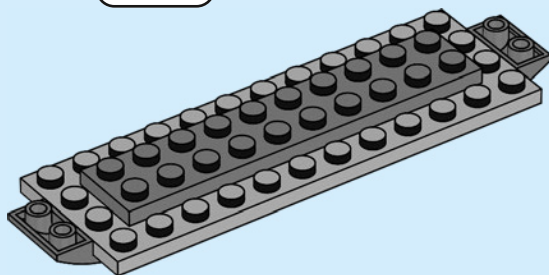

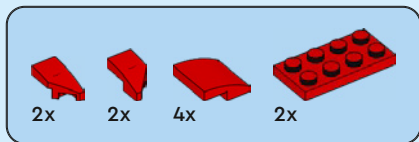

43

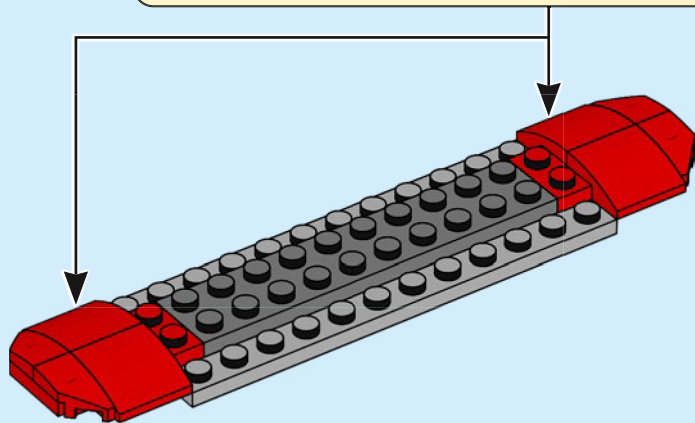
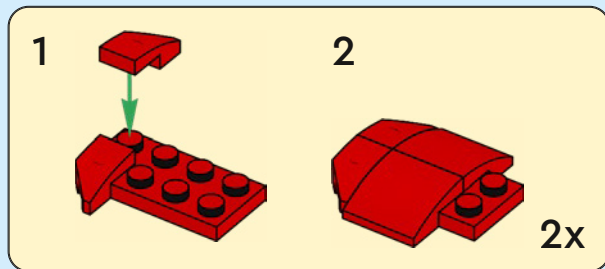



4x

44

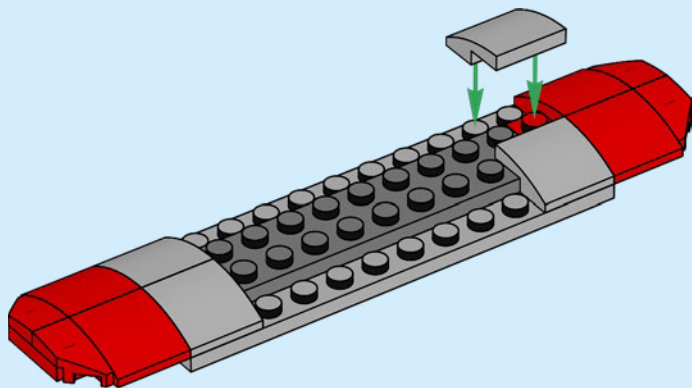



4x



2x

45

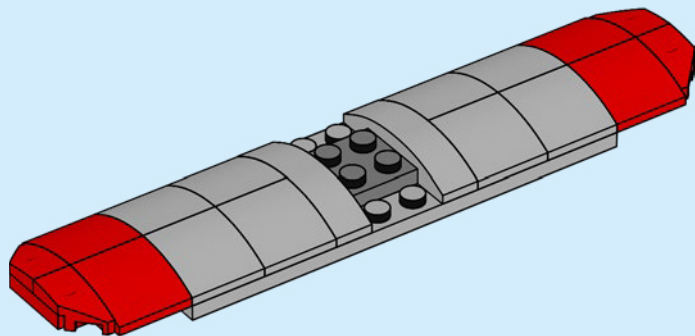



1x



1x

46

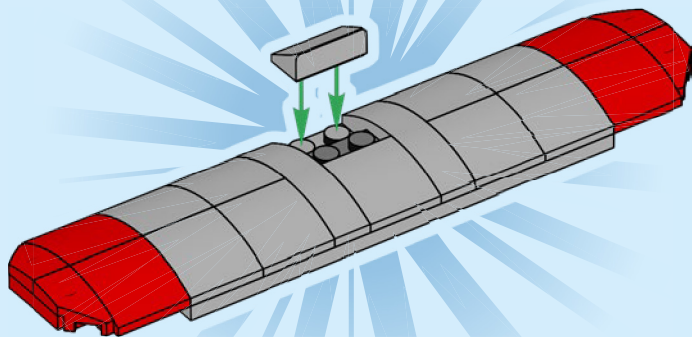

47

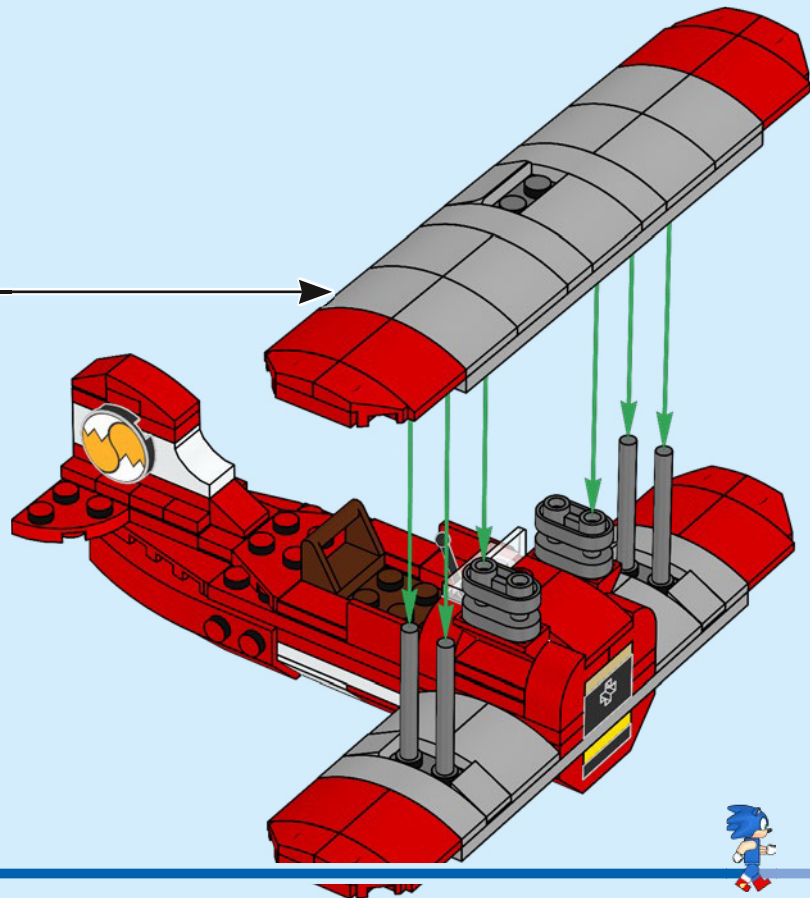

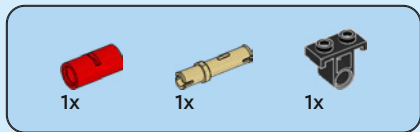

48

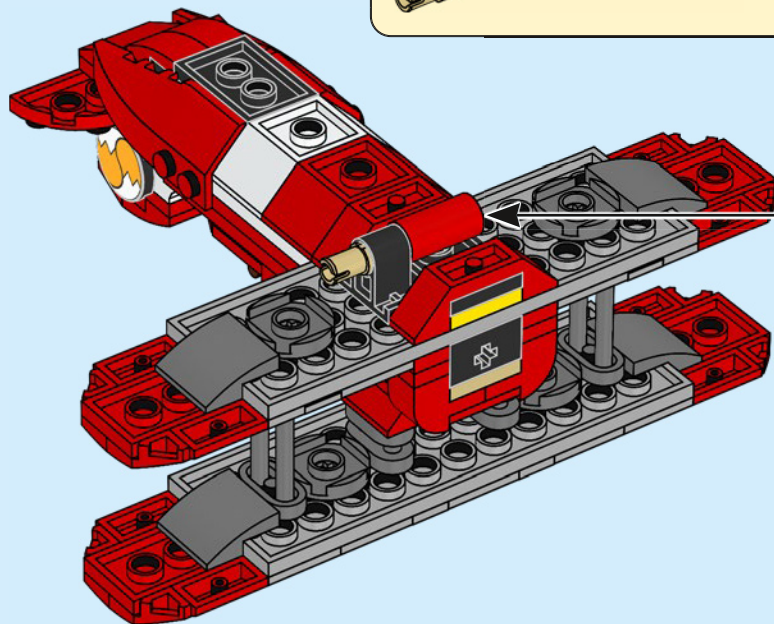
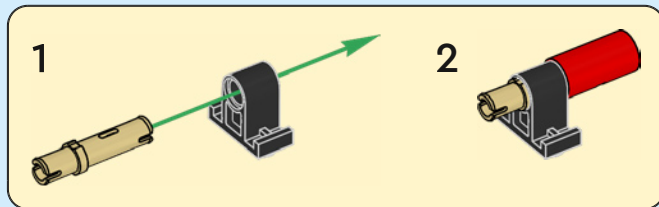



1x



1x

49

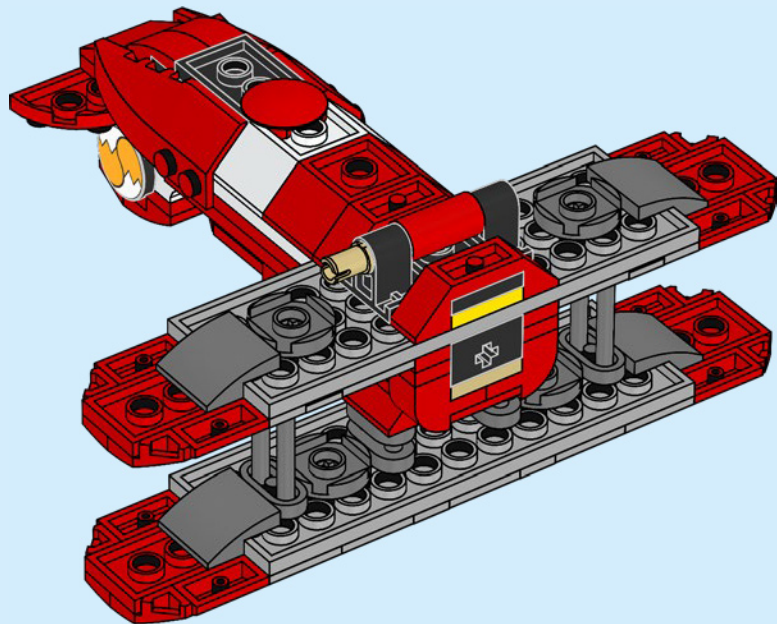



1x

50

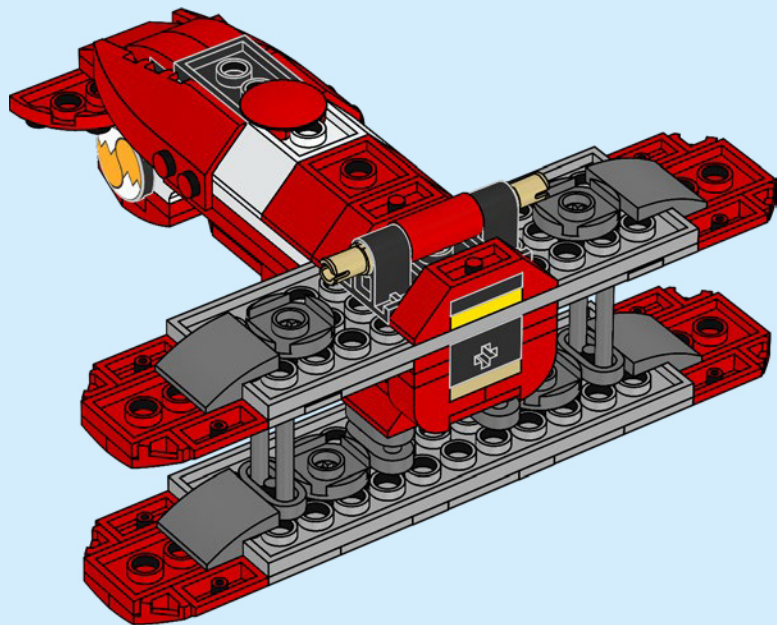



2x



2x

51



2x

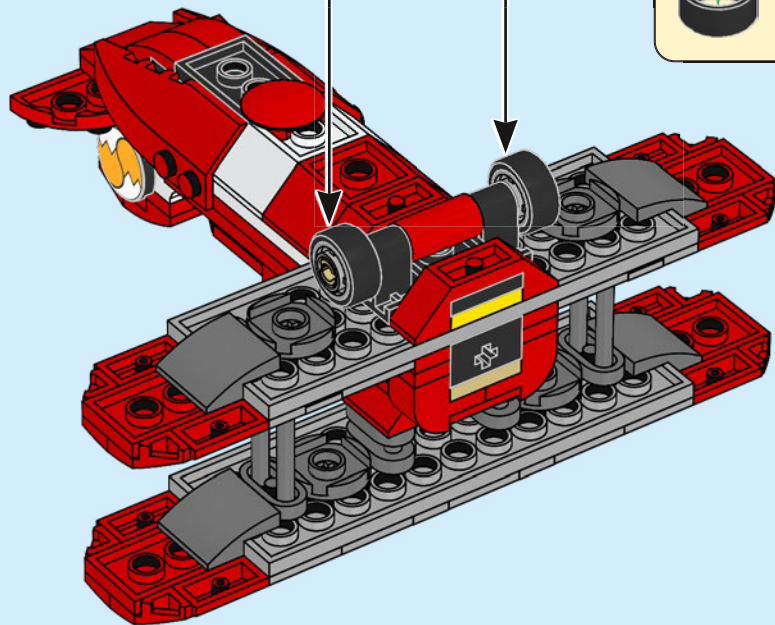

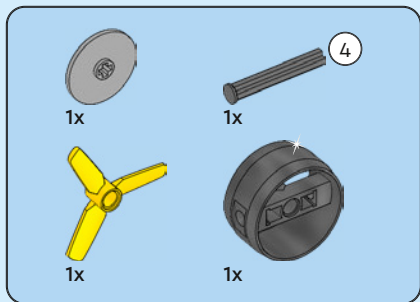

52

1

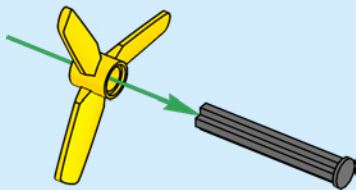

2

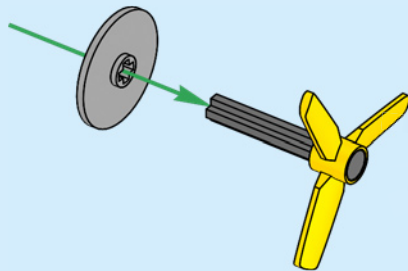

3

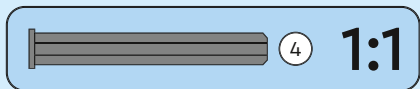

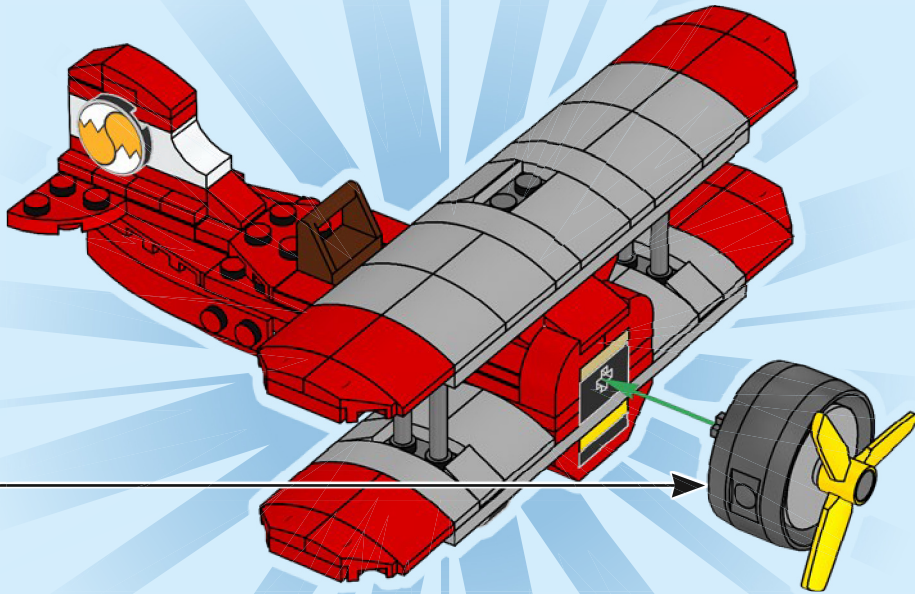



LEGO and the LEGO logo are trademarks of the LEGO Group. ©2023 The LEGO Group.
©SEGA. All rights reserved. SEGA is registered in the U.S. Patent and Trademark Office.
SEGA and SONIC THE HEDGEHOG are either registered trademarks or trademarks of
SEGA CORPORATION. 6493747

Rebuild
the
world™

