



# MINECRAFT

21243





[LEGO.com/sustainable-packaging](https://LEGO.com/sustainable-packaging)



# BUILDER



Apple and the Apple logo are trademarks of Apple Inc., registered in the U.S. and other countries and regions. App Store is a service mark of Apple Inc. Google Play and the Google Play logo are trademarks of Google LLC. Tencent and the Tencent logo are trademarks of Tencent Inc.

LEGO.com/devicecheck

EN Ask parents' permission before going online | DE Eltern um Erlaubnis bitten, bevor du online gehst | FR Demande l'autorisation d'un parent avant d'aller en ligne | IT Chiedi il permesso ai tuoi genitori prima di andare online | ES Pídeles permiso a tus papás antes de conectarte a Internet | PT pede autorização aos pais antes de acederes online | JA オンラインになる前にほご者の方のきよかをもらおう | ZH 上网前应先征得父母的同意 | KO 온라인 접속 전에 보호자 동의가 필요합니다 | RU Спроси разрешения у родителей, прежде чем заходить в интернет | PL Poproś rodziców o zgodę, zanim wejdiesz do Internetu | CS Než půjdeš na internet, požádej rodiče o svolení | SK Skôr než pôjdeš na internet, vypýtaj si povolenie od rodičov | HU Kérj szülői engedélyt, mielőtt online csatlakoznál! | RO Cere permisiunea părinților înainte de a te conecta online | BG Поискайте разрешение от родител, преди да влезете онлайн | LV Pirms došanās tiešsaistē palūdz atļauju vecākiem | ET Enne Interneti kasutamist küsi vanematelt luba | LT Prieš prisijungdami prie interneto, atsiklauskite tėvų

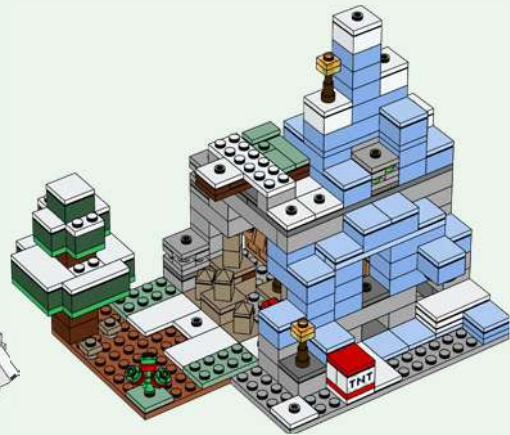
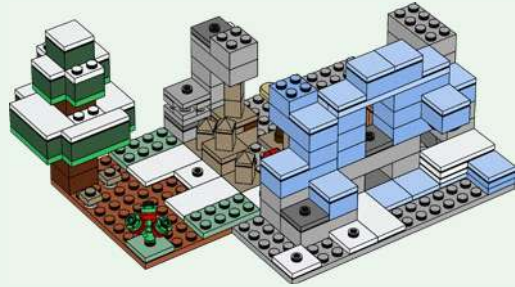
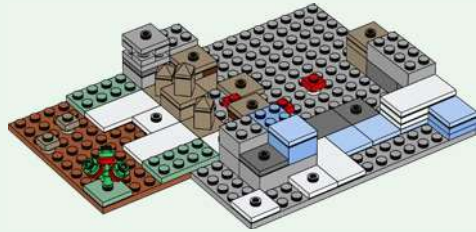

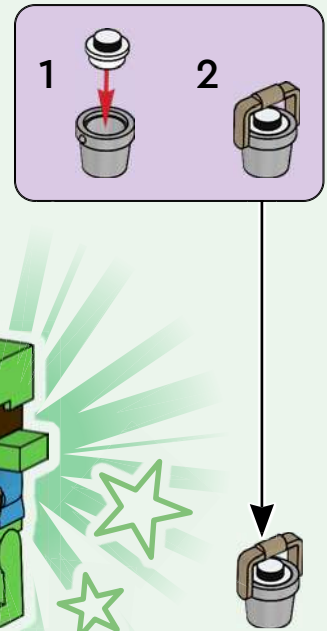
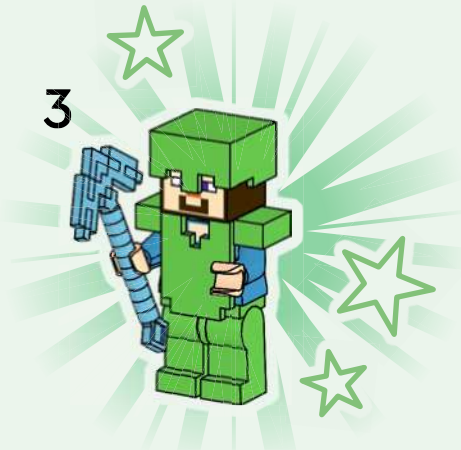
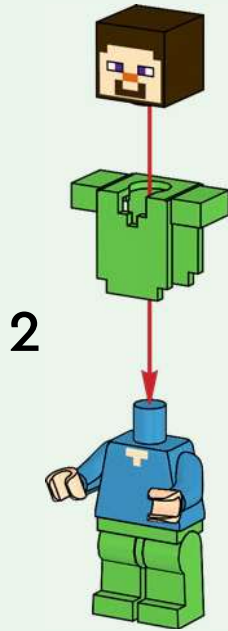
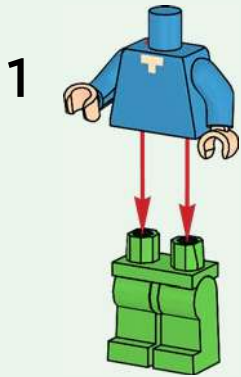
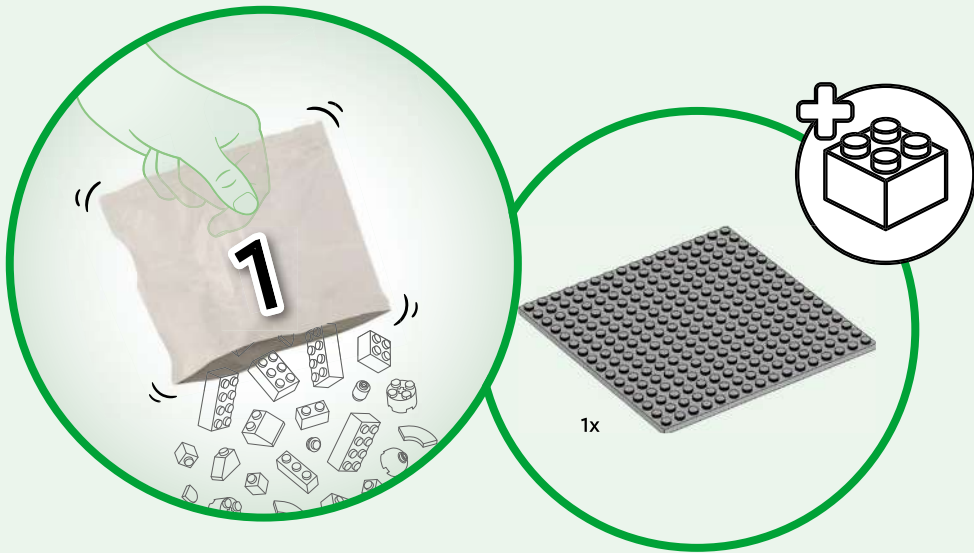



2x

1

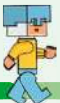
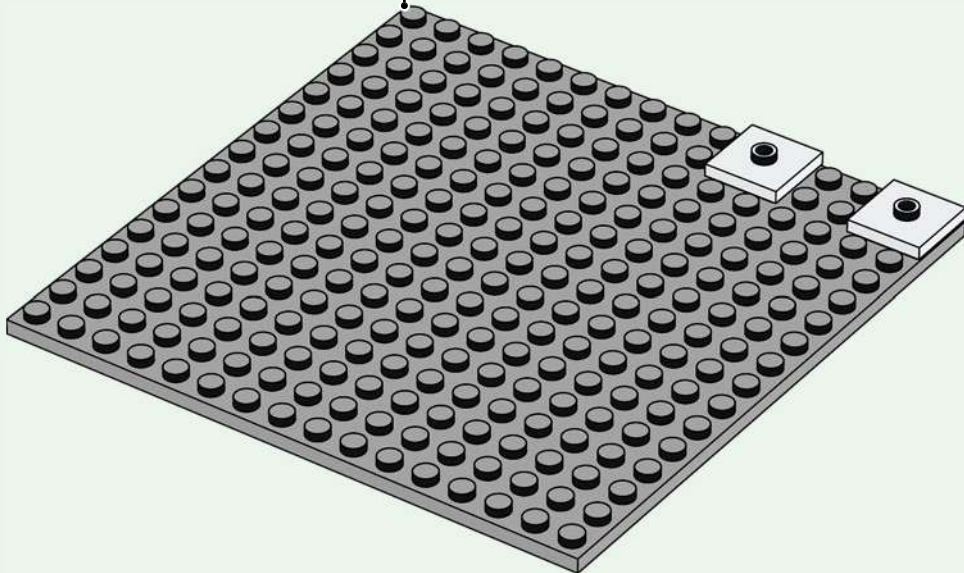
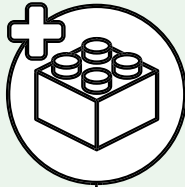

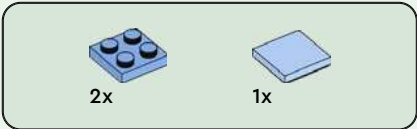

2

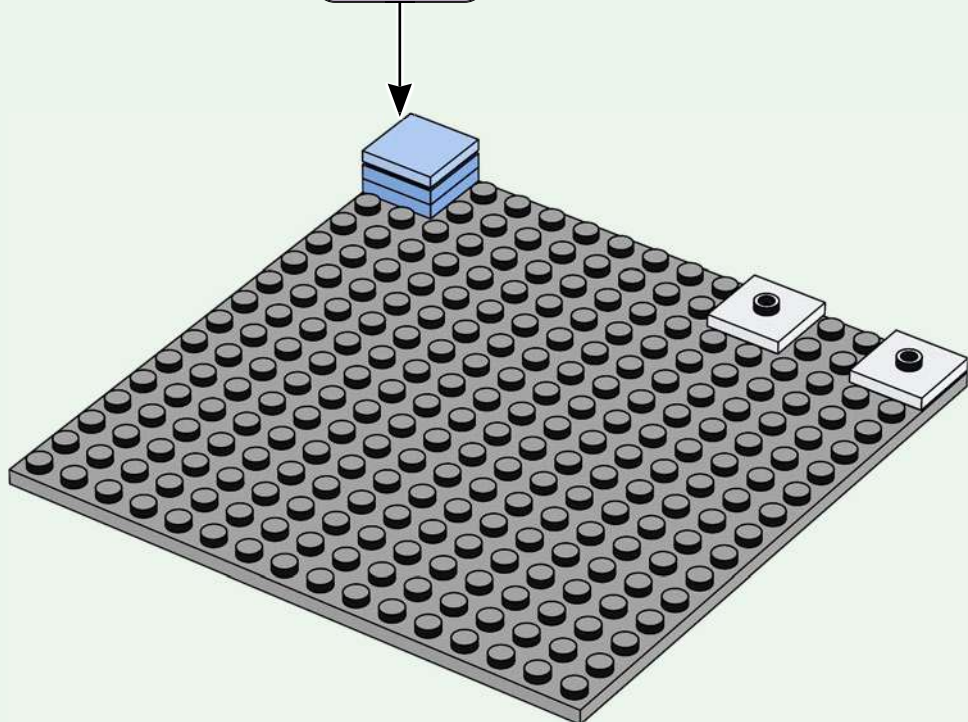
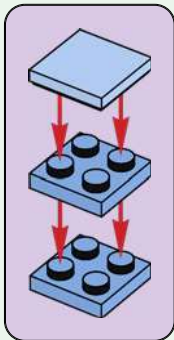

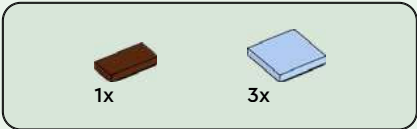

3

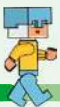
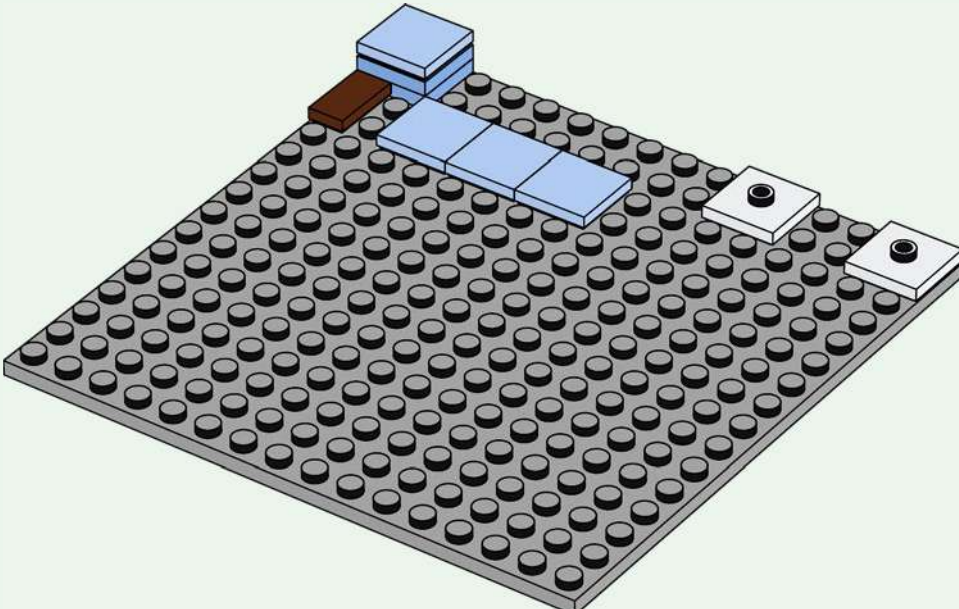



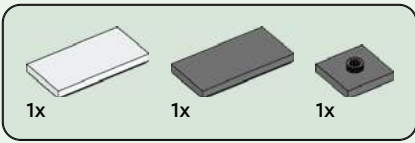

4

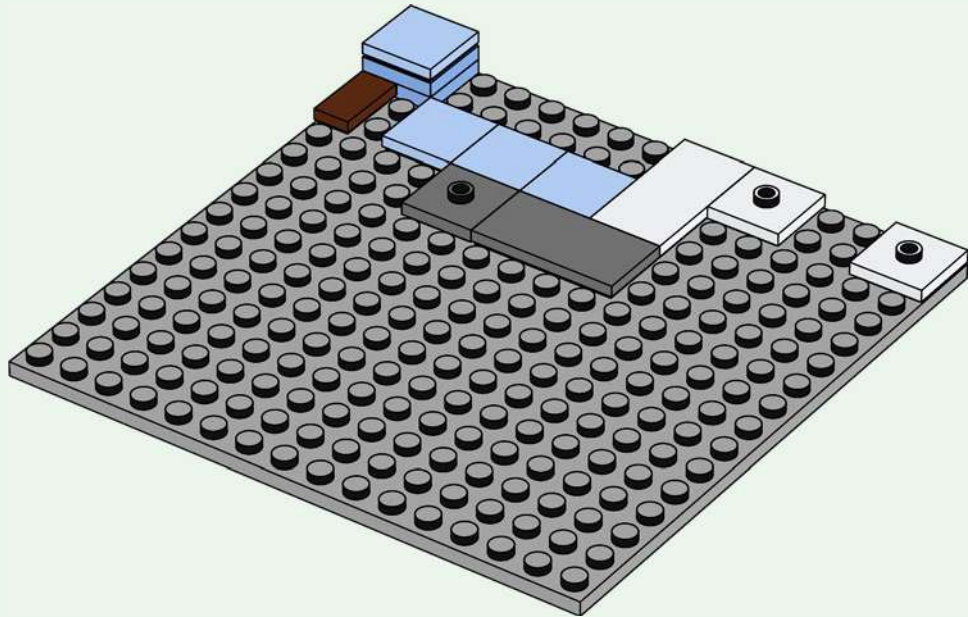



2x

5

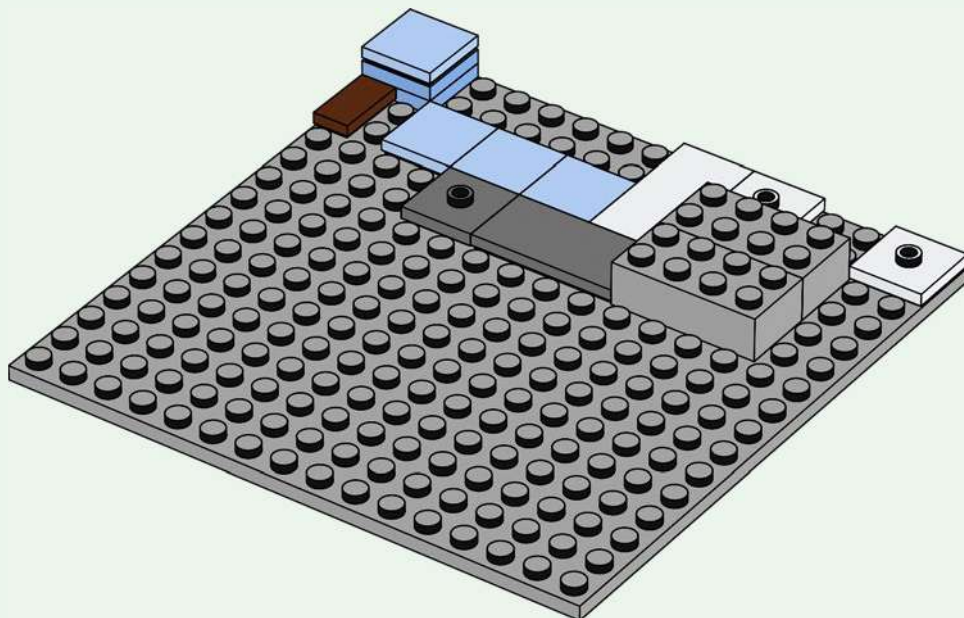

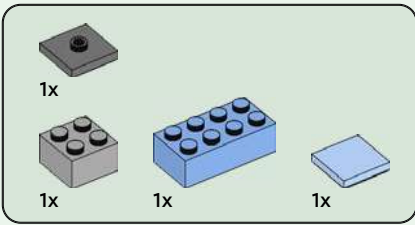

6

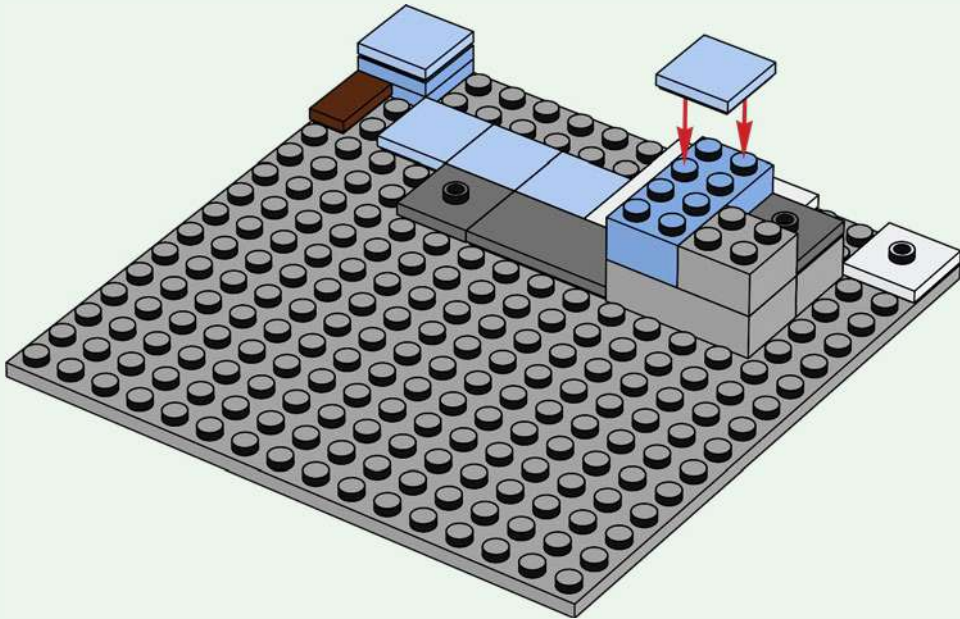

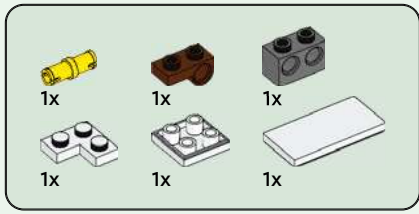

# 7

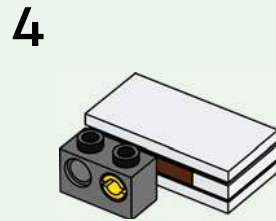
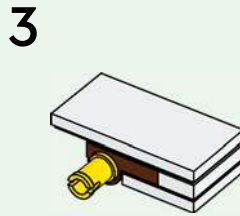
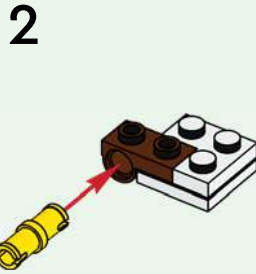
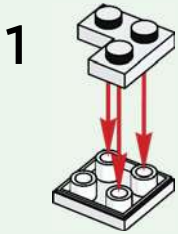

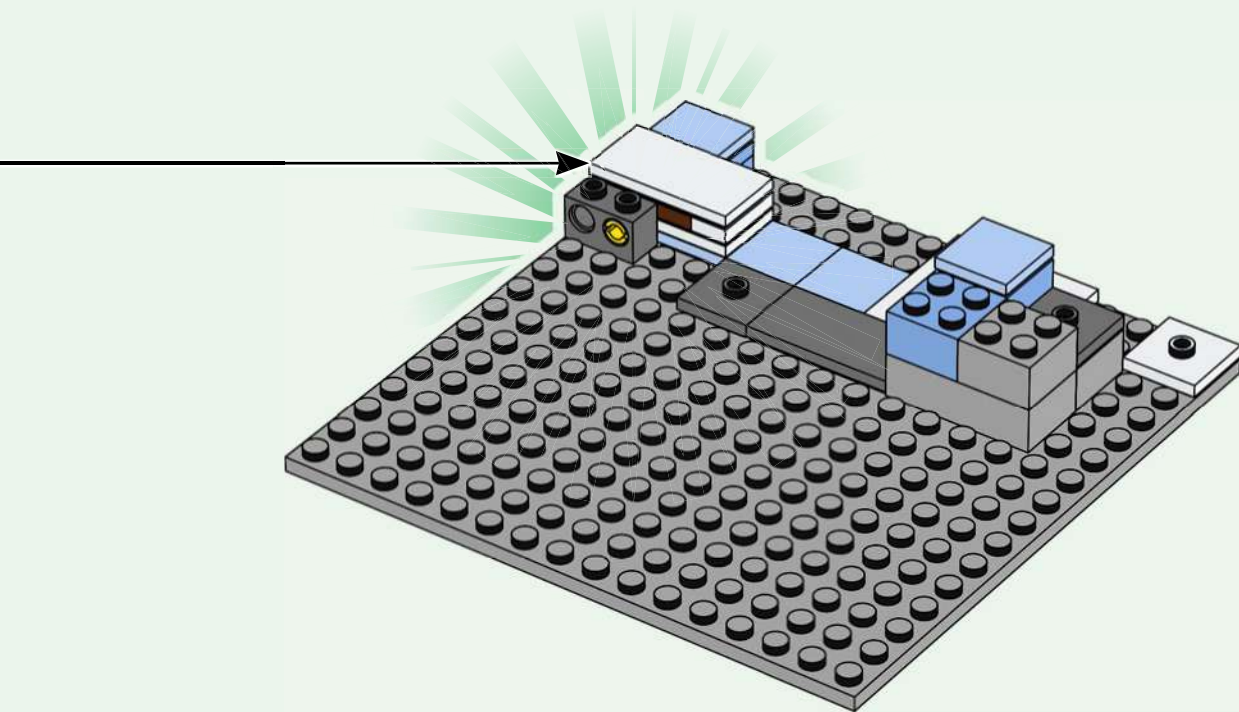



1x

8

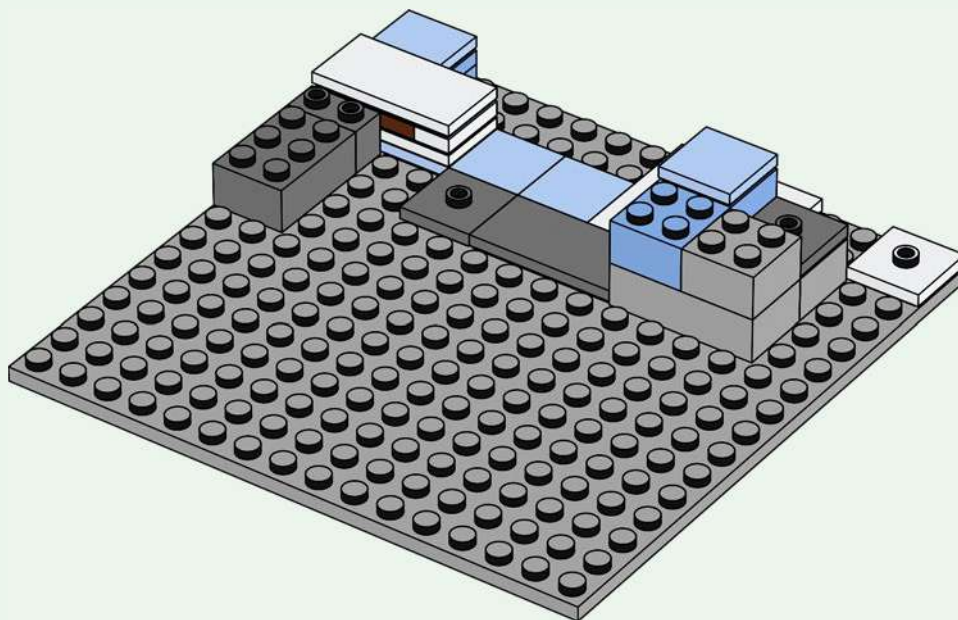

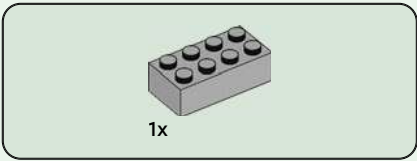

9

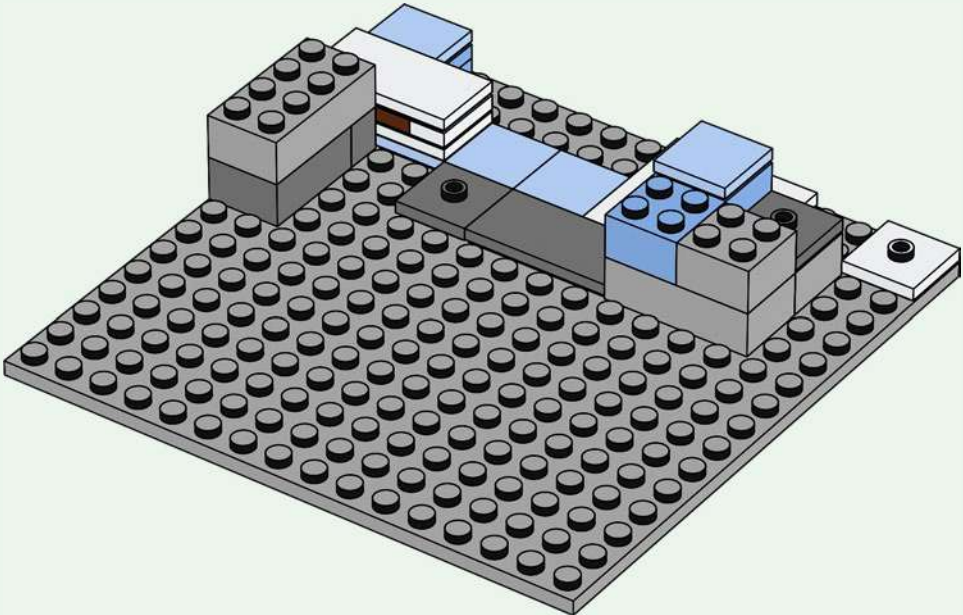

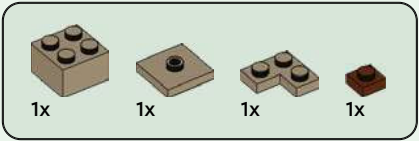

10

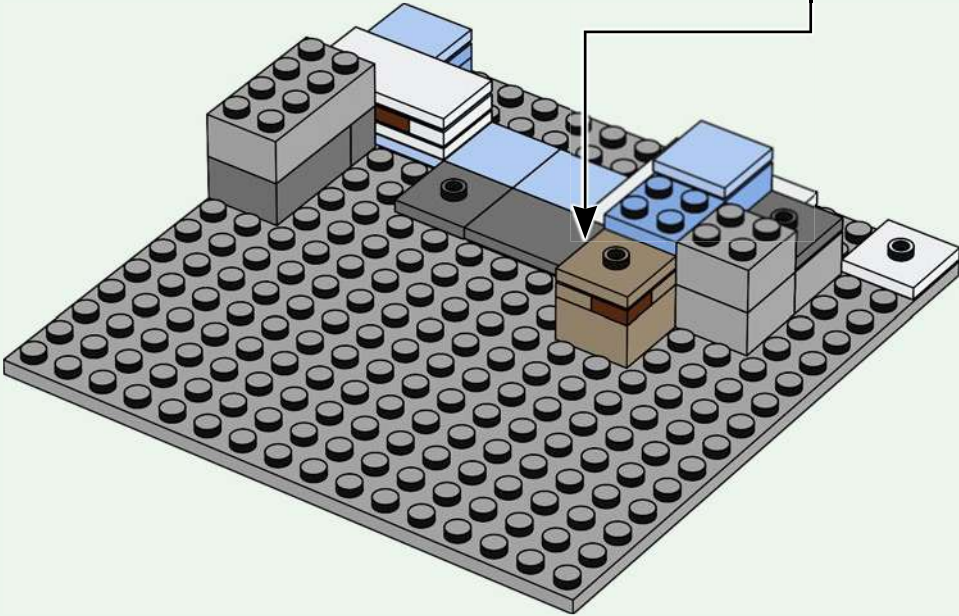
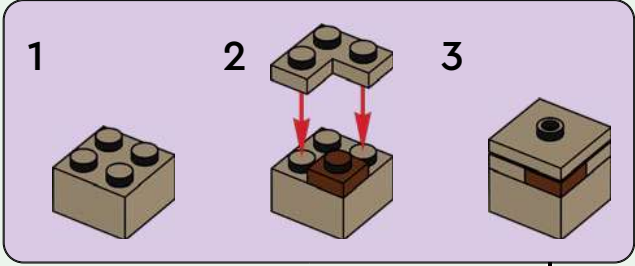





3x



3x

11

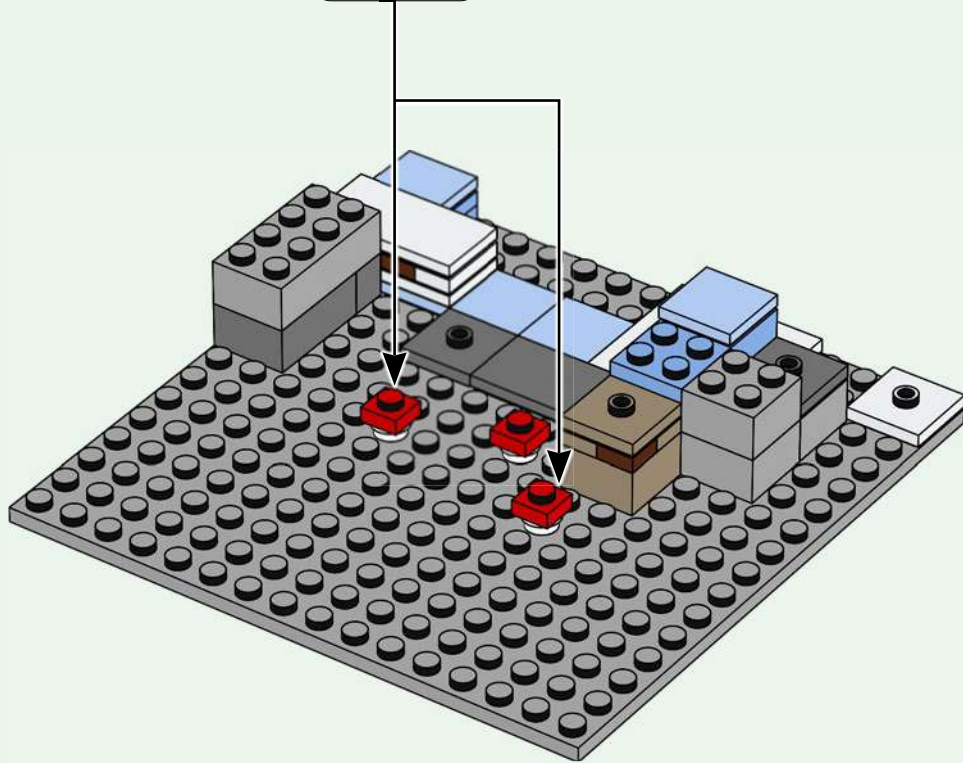
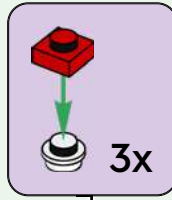



1x



1x

12

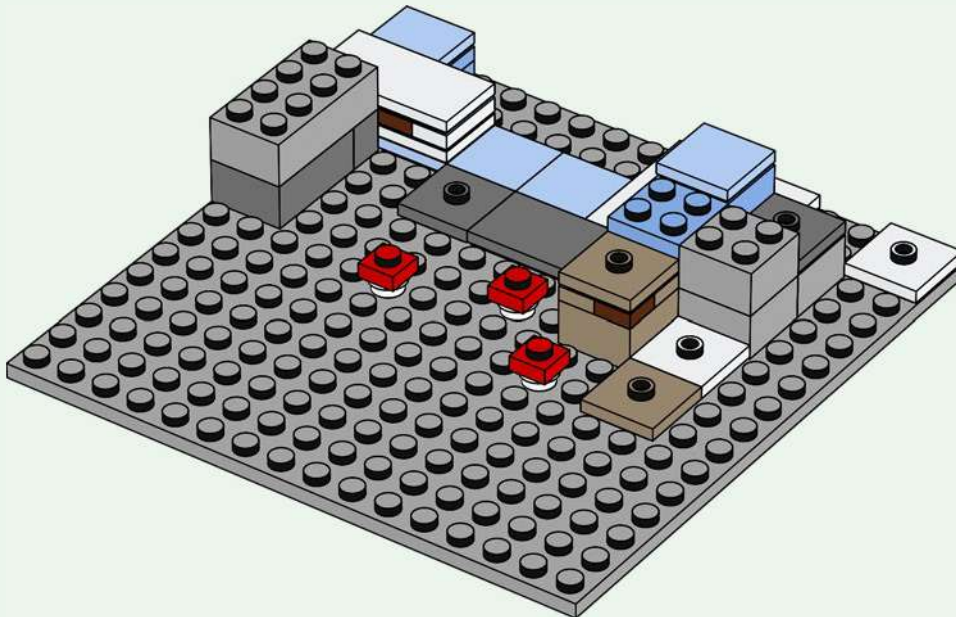

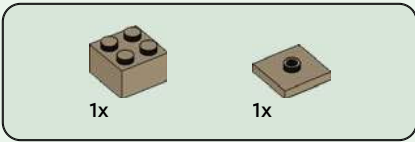

13

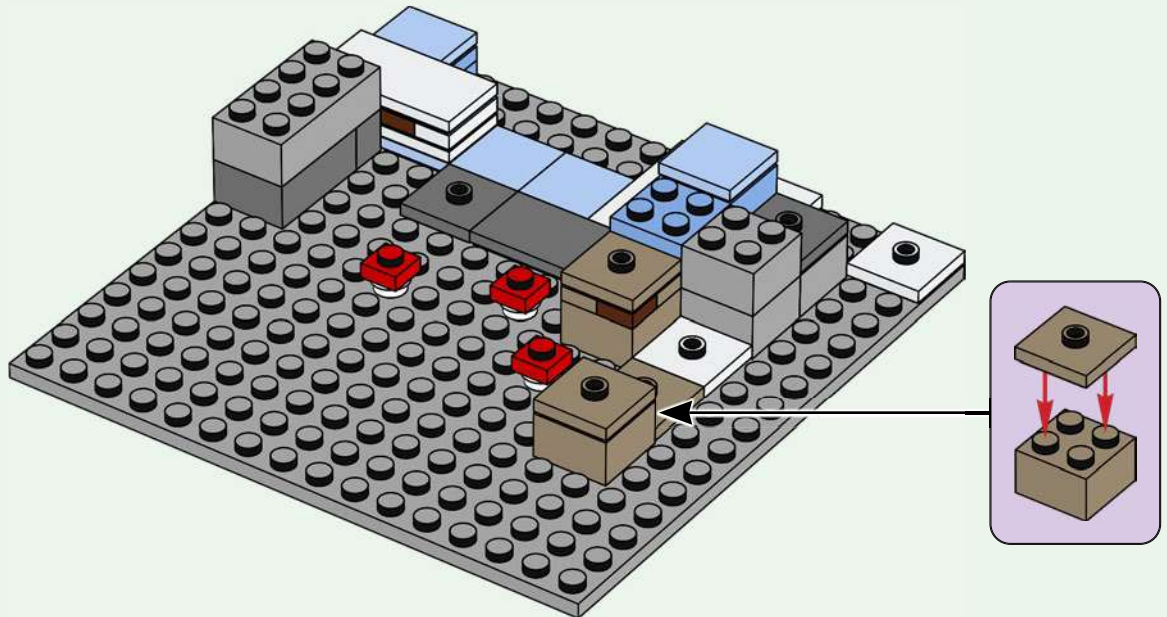



2x

# 14

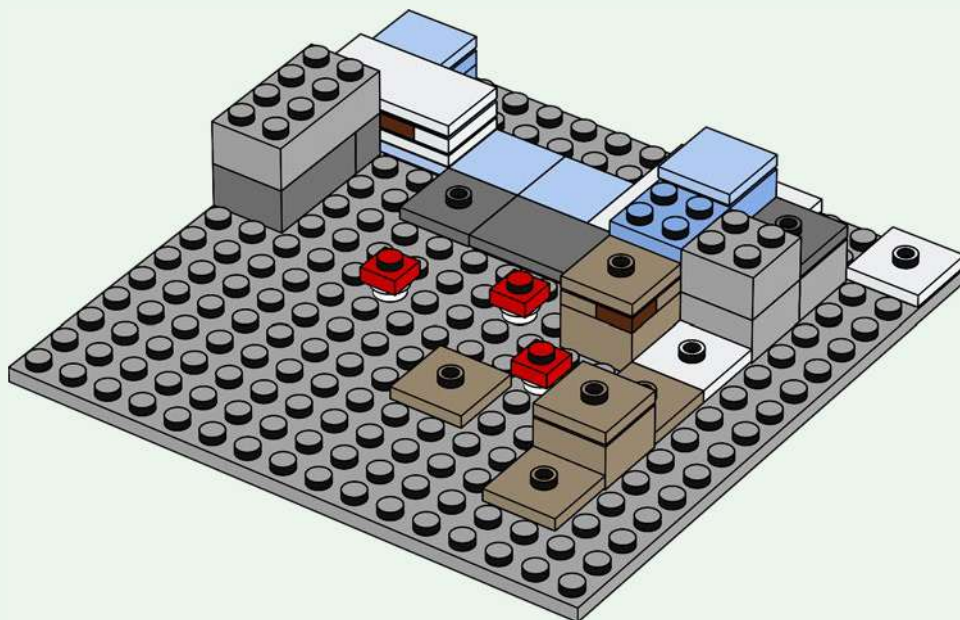

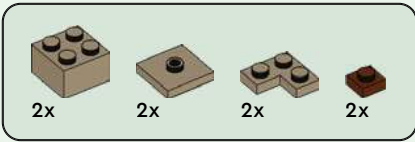

15

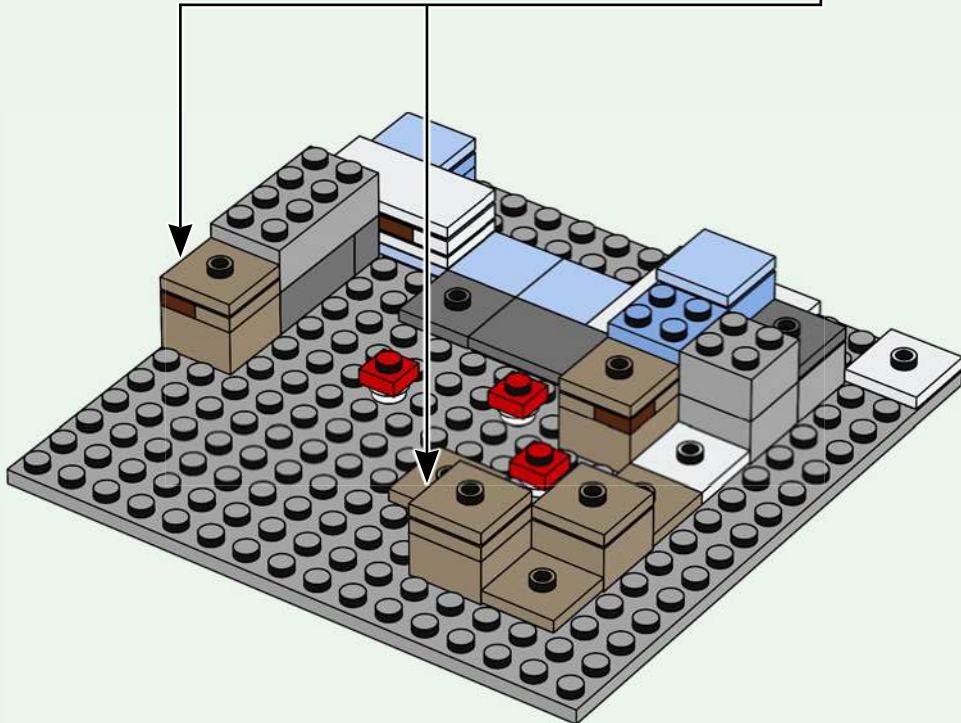
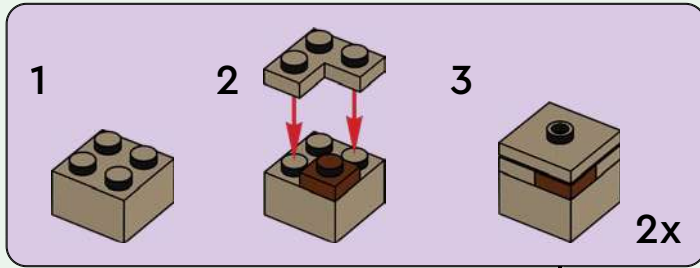



3x



3x

16

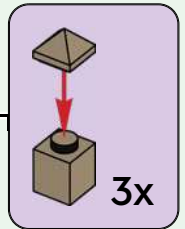
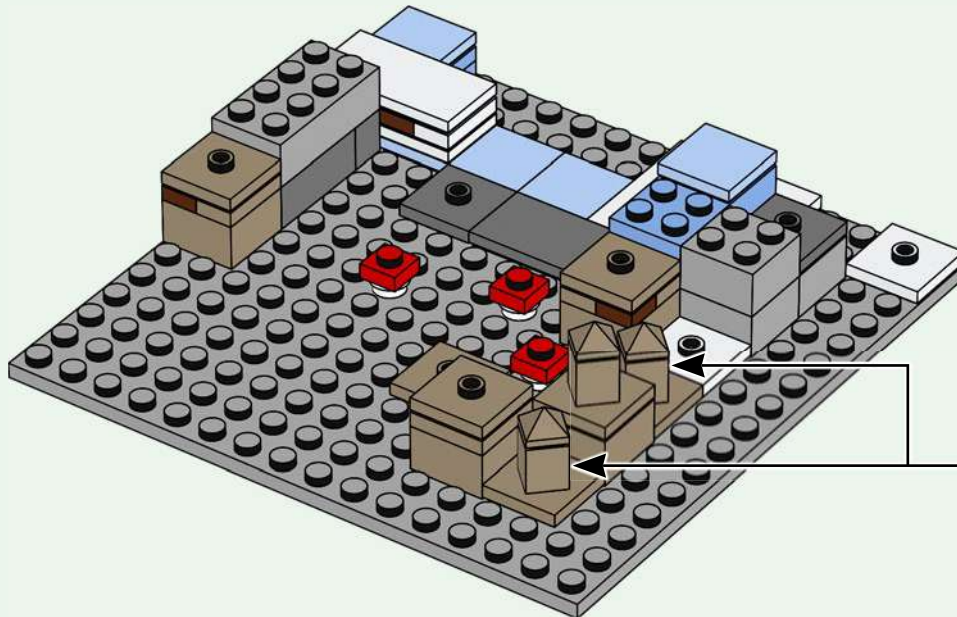

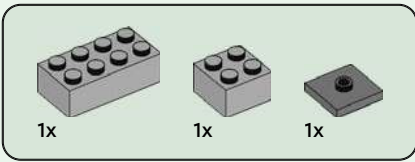

17

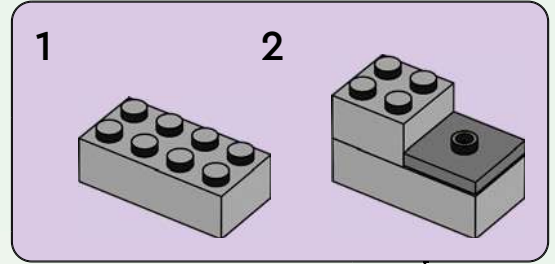

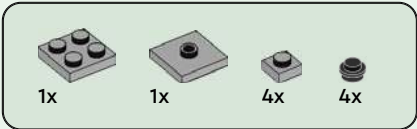

18

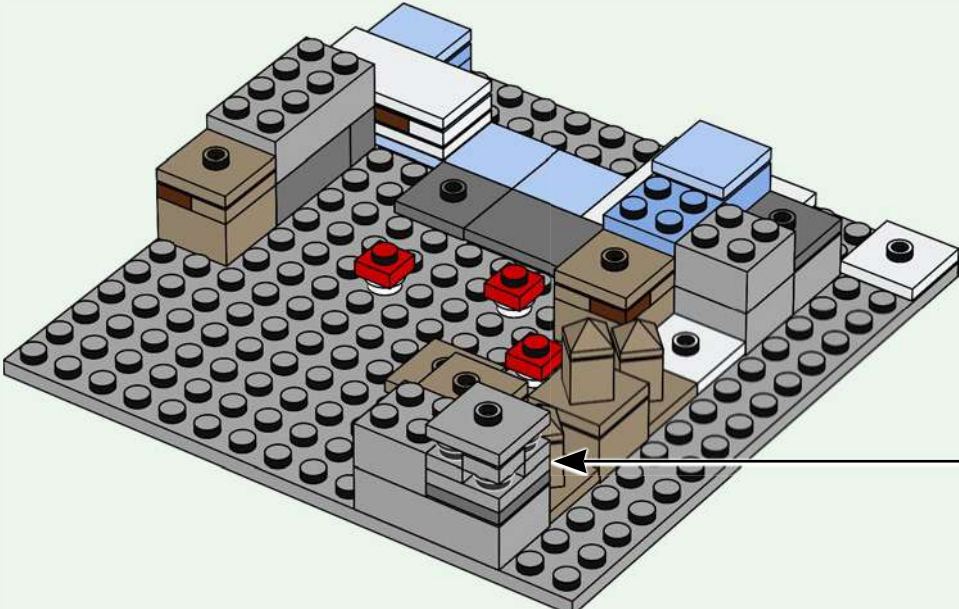
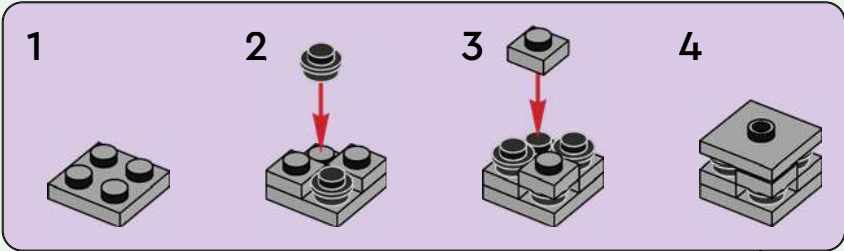



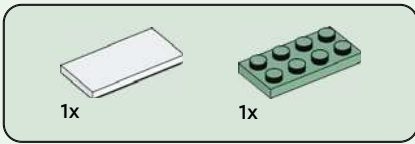

19

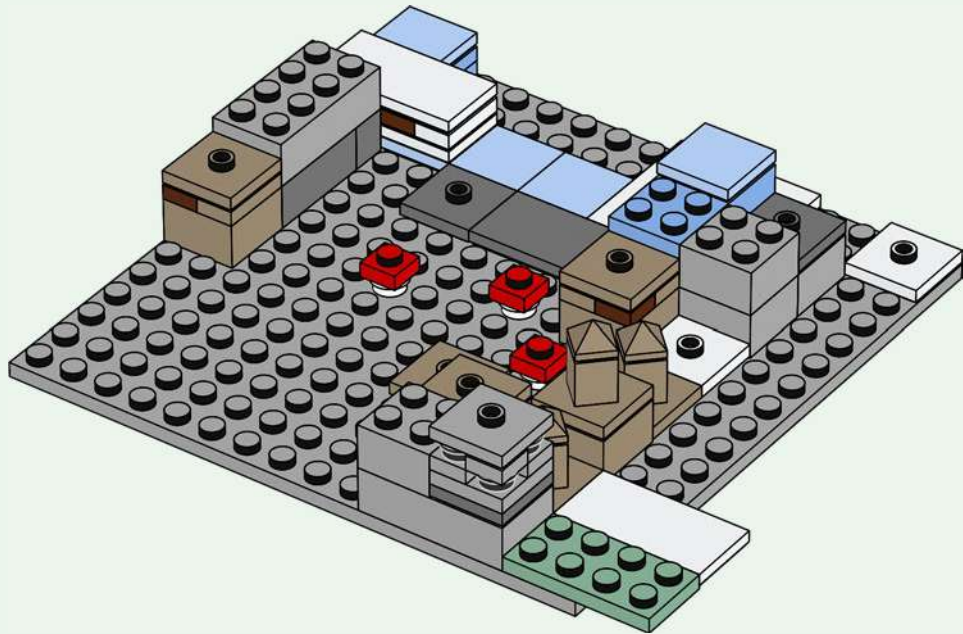

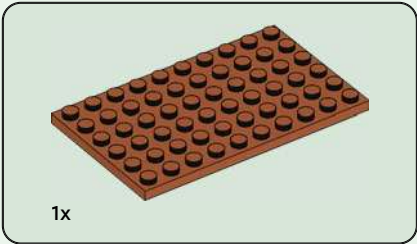

20

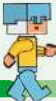
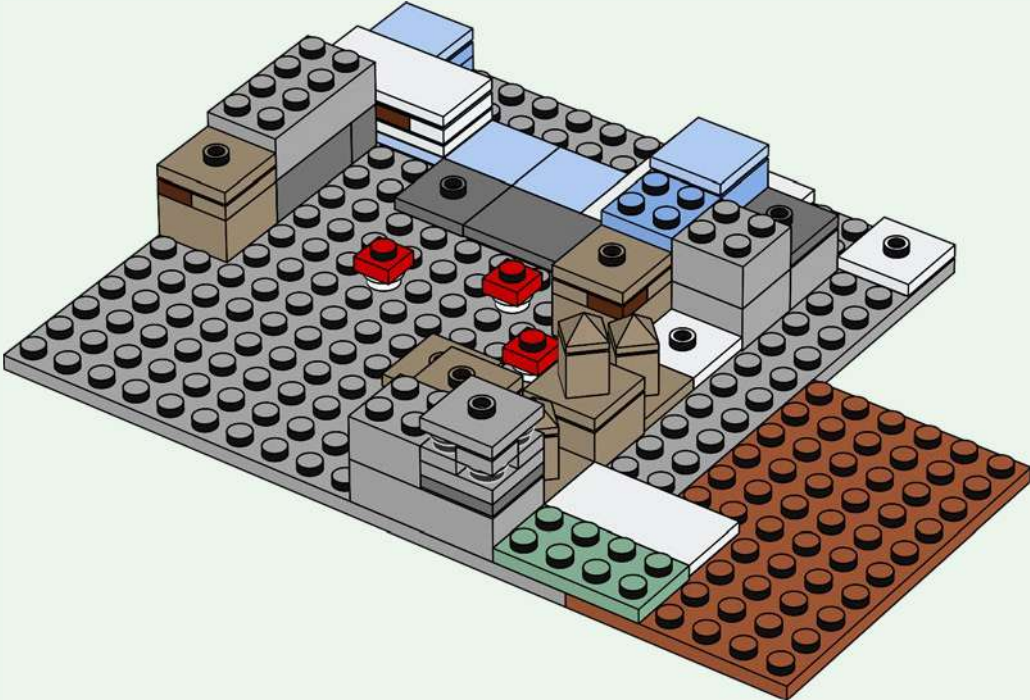

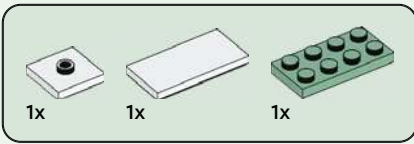

21

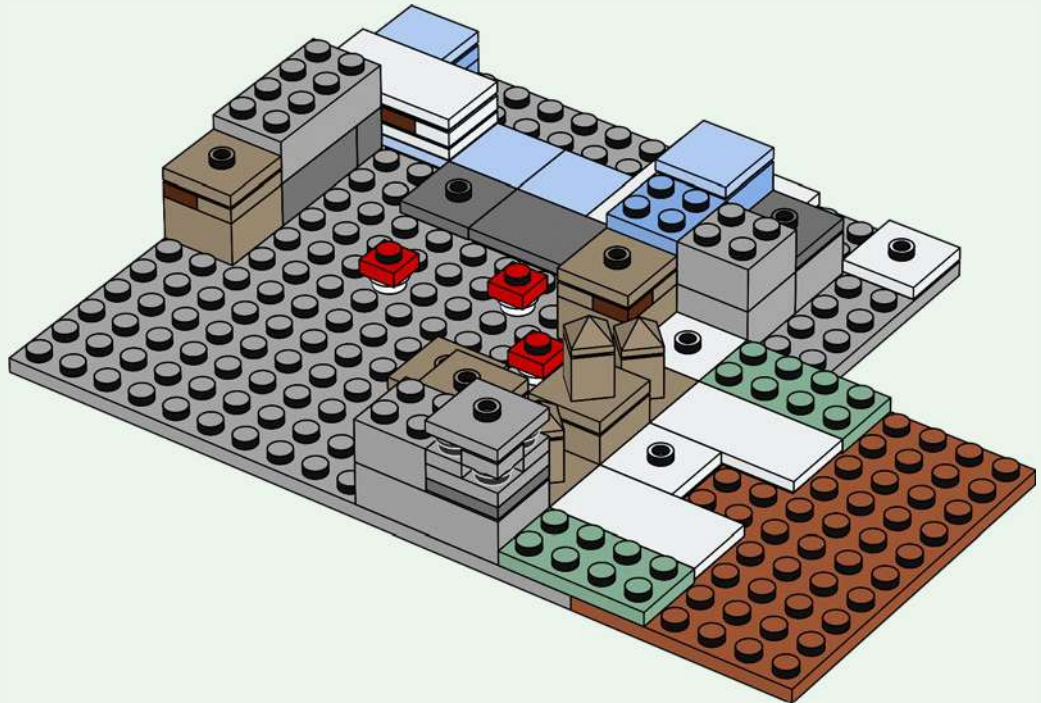

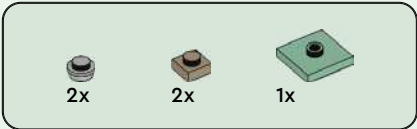

22

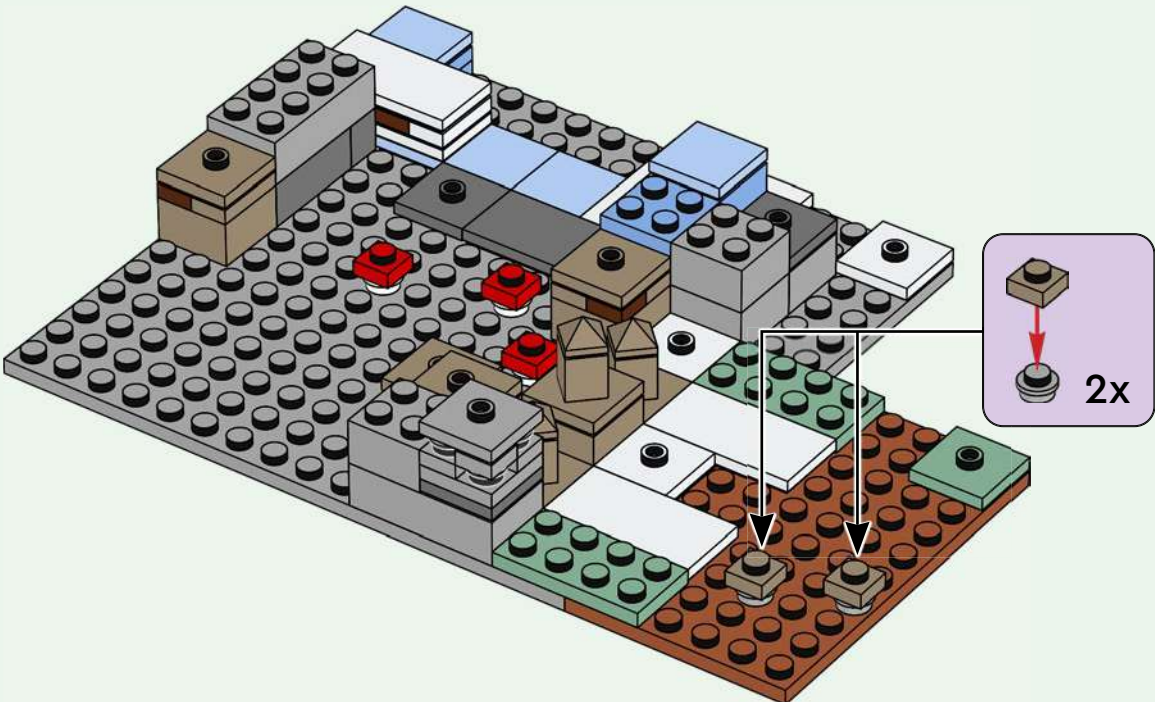



23

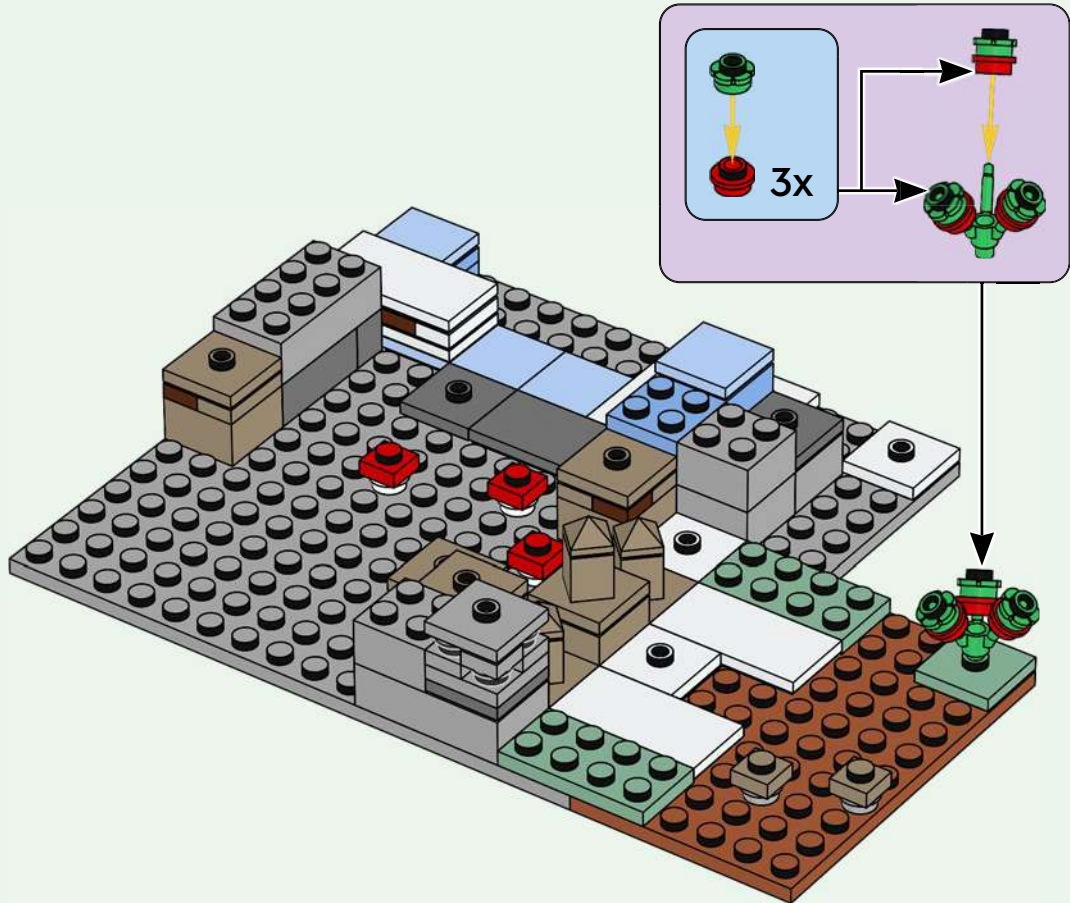

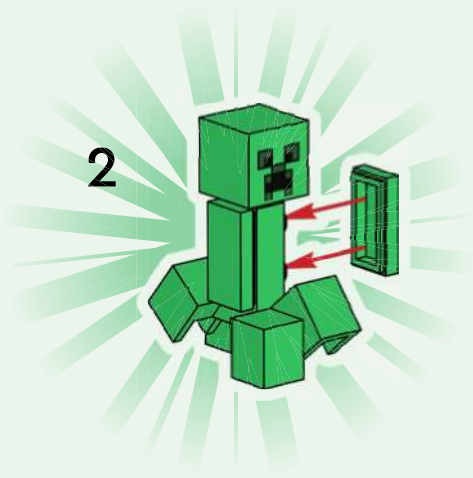
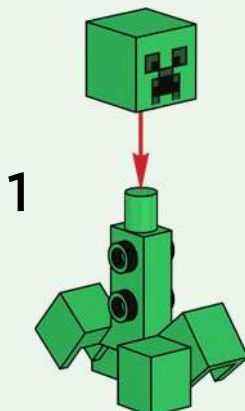

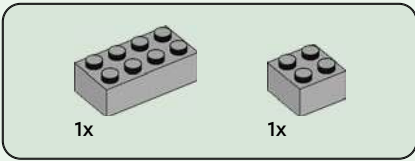

24

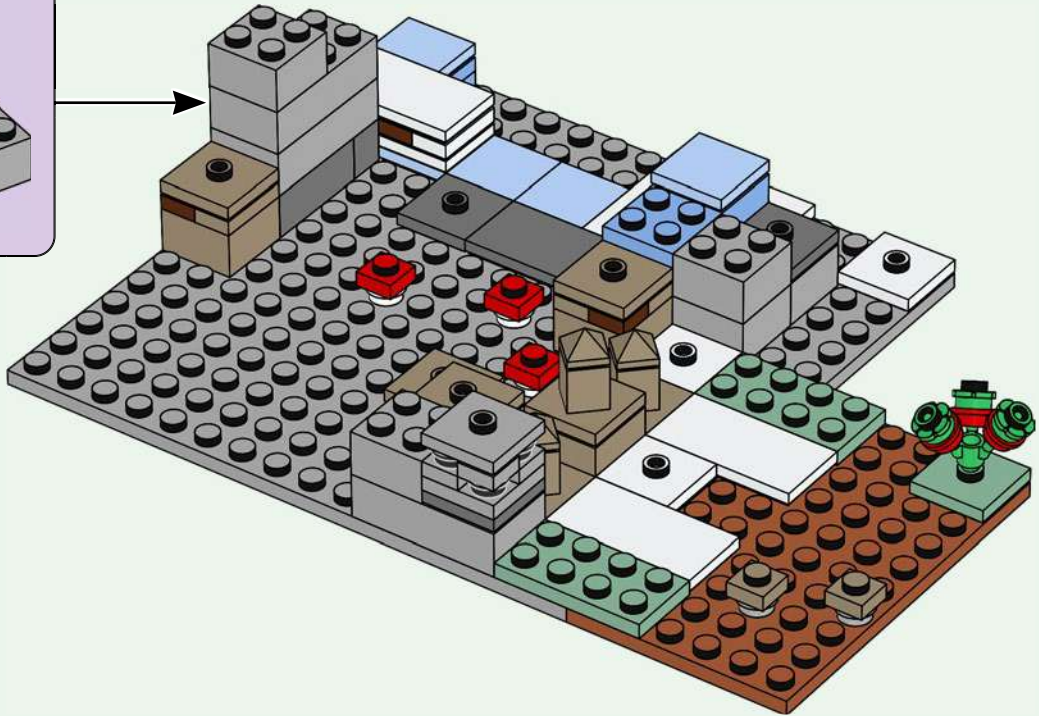
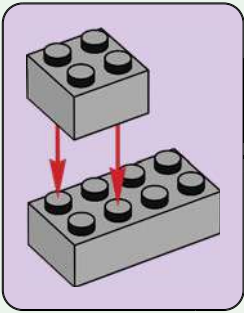

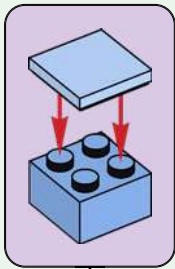
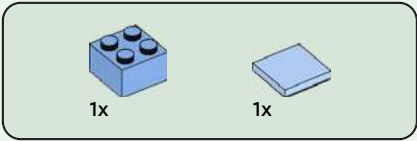

25

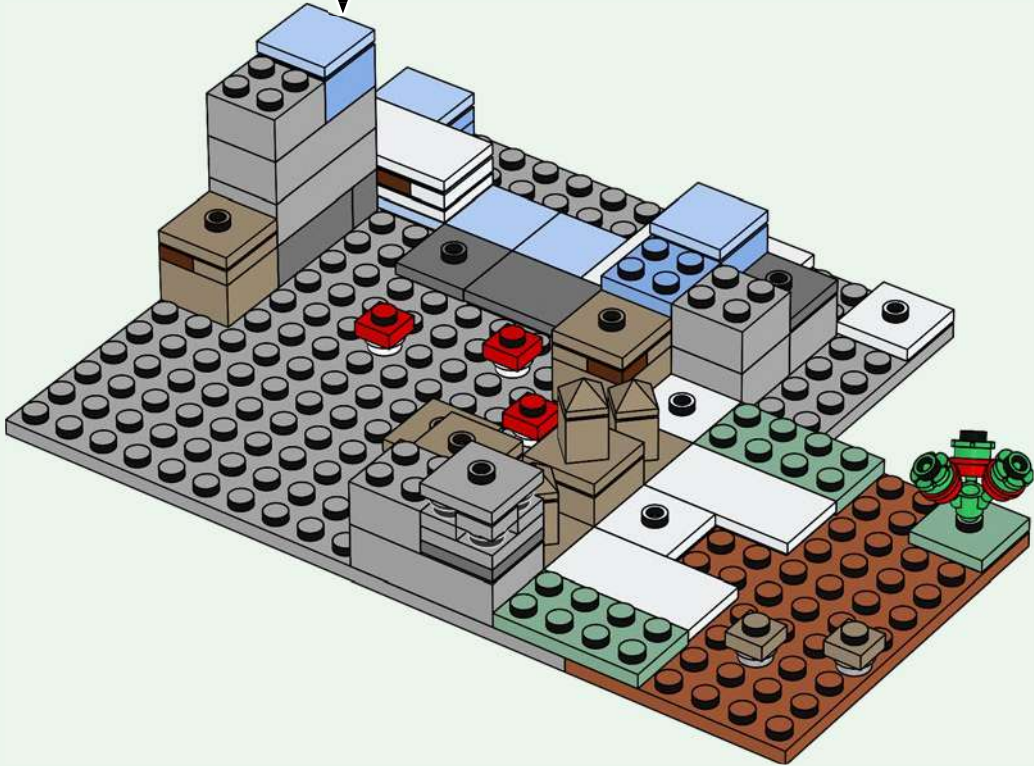



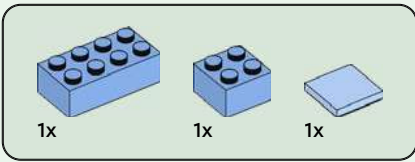

26

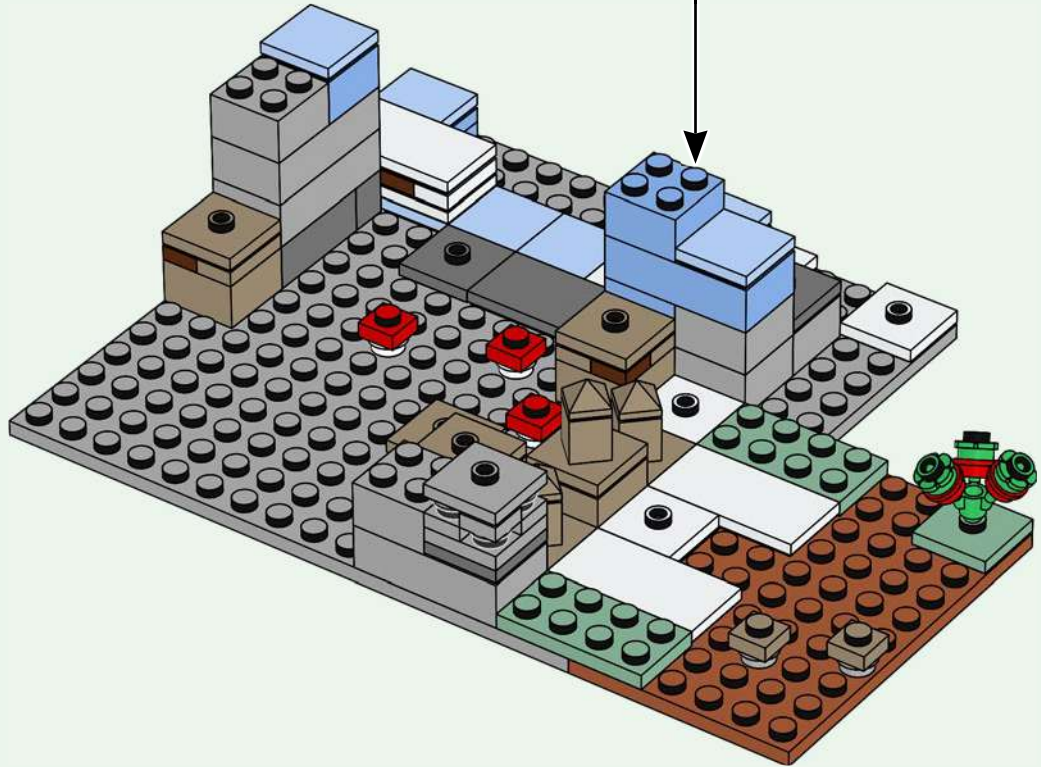
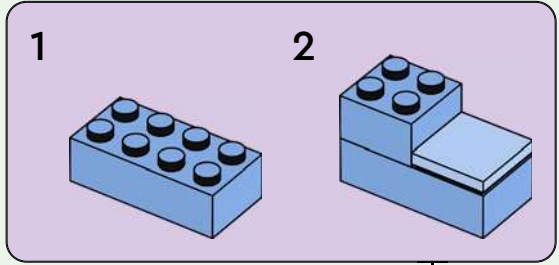

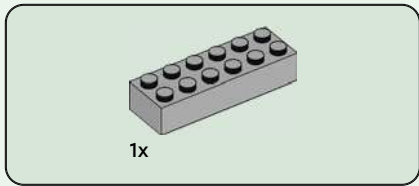

27

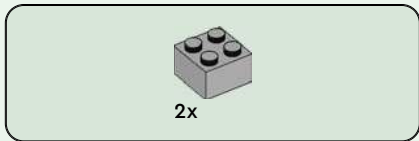
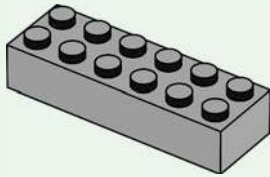

28

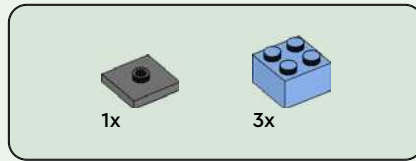
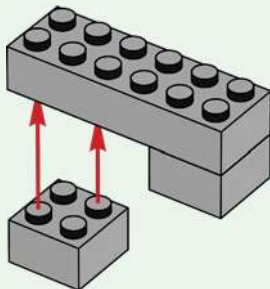

29

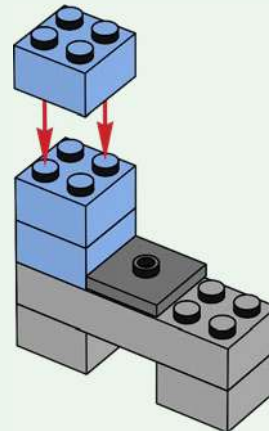

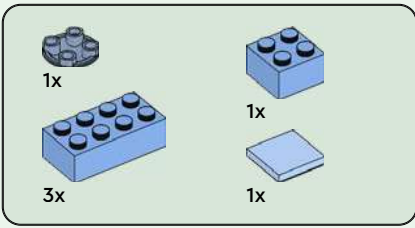

30

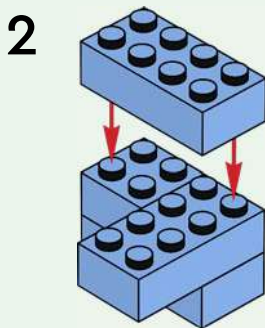
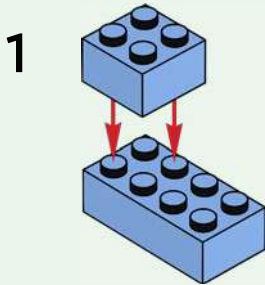

3

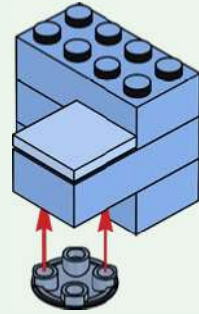

31

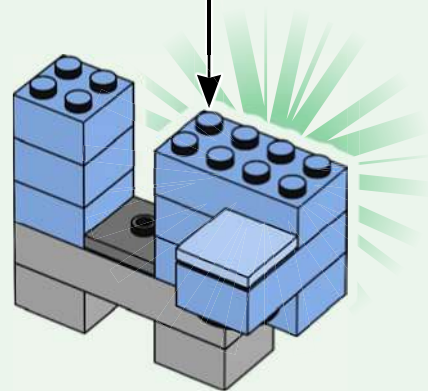

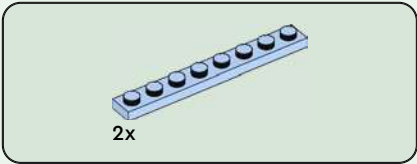

32

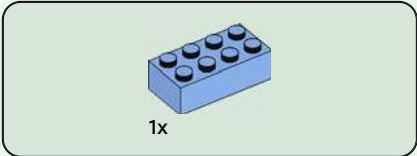
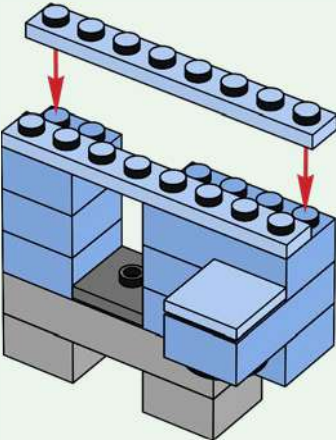

33

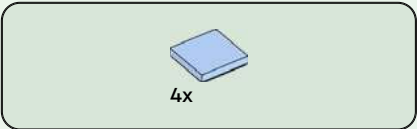
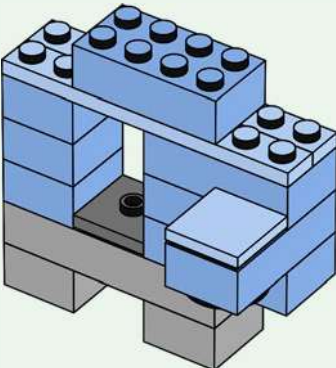

34

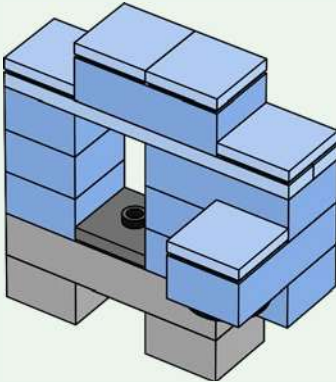

35

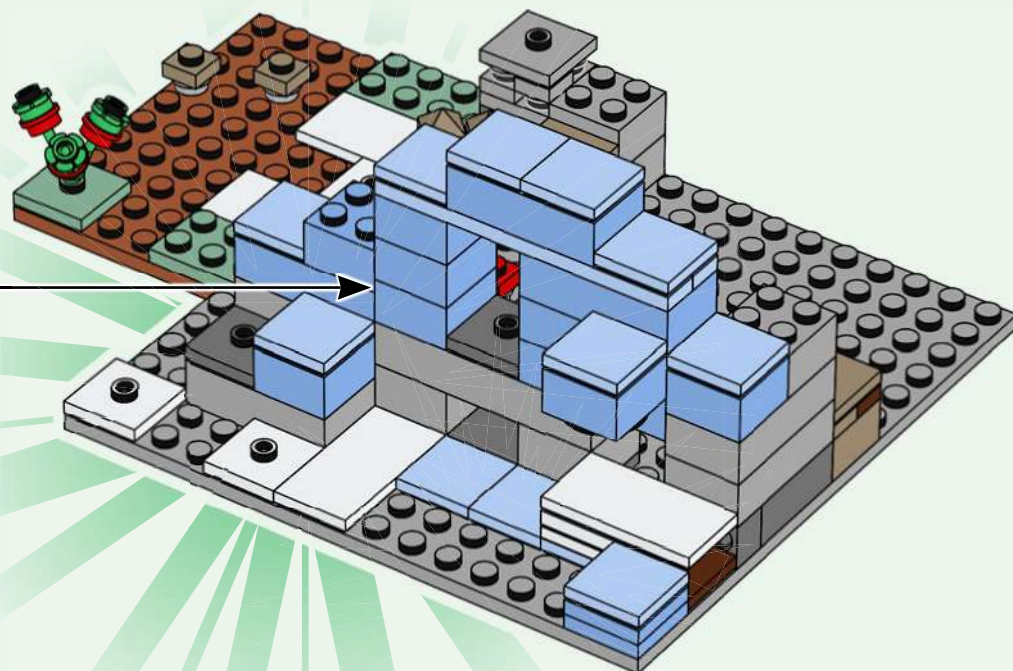



36

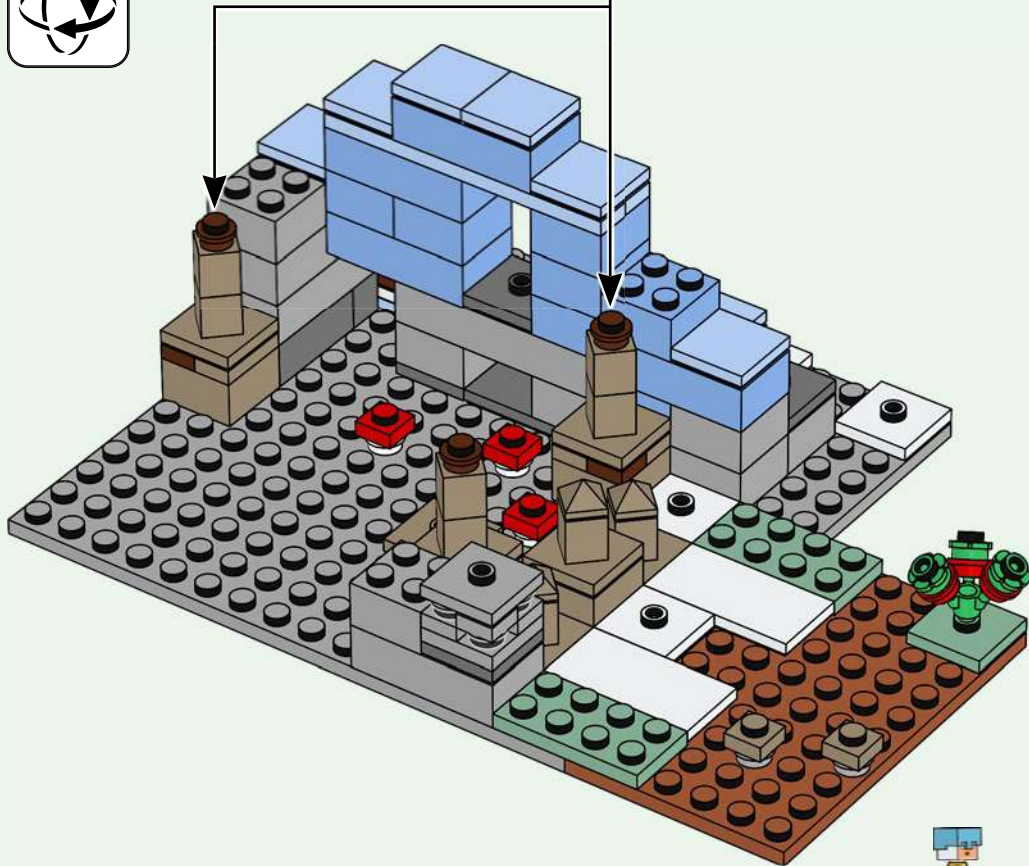
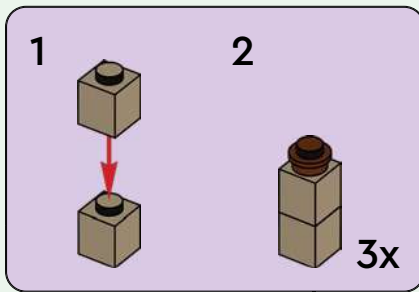

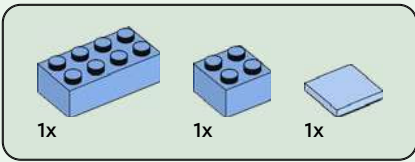

37

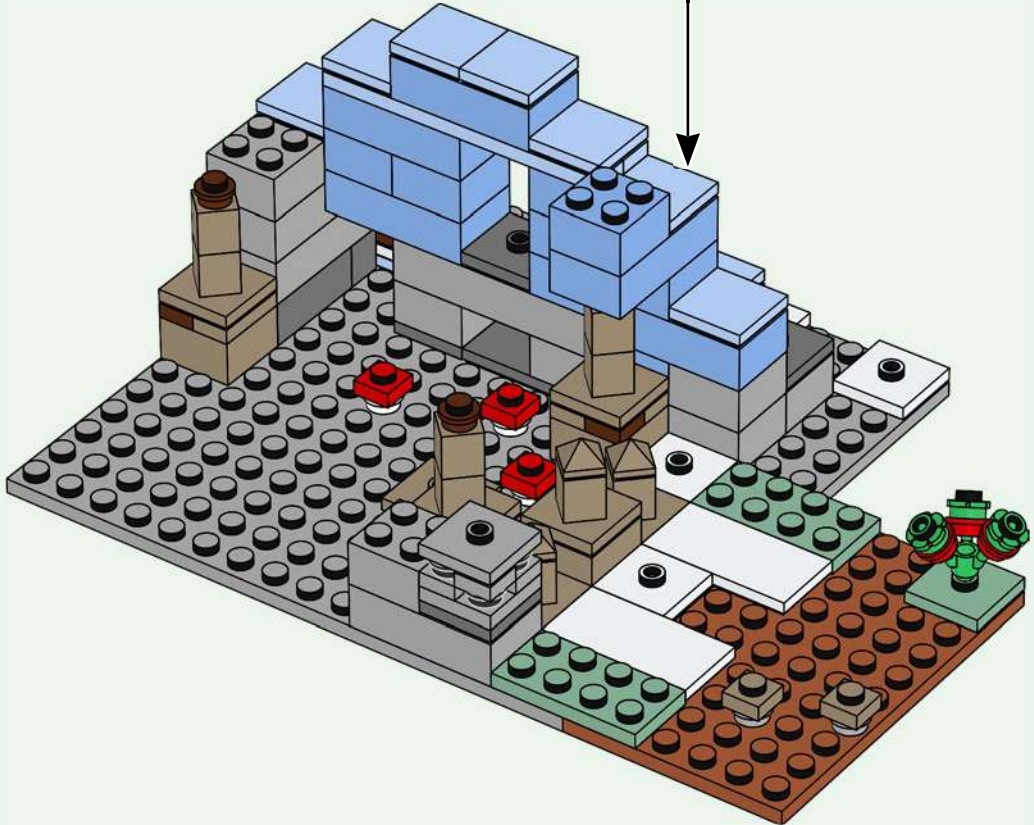
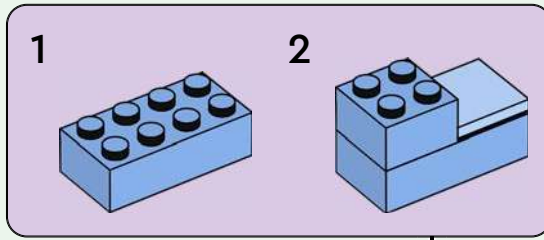



2x

# 38

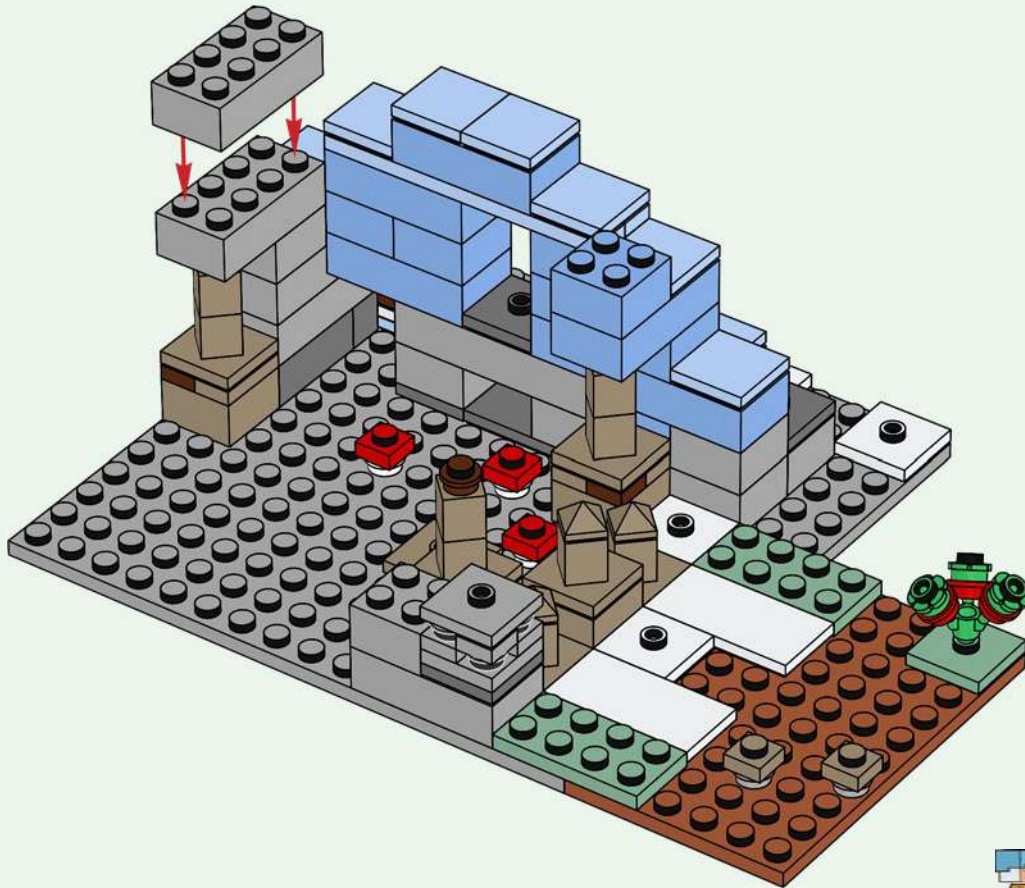





2x

39

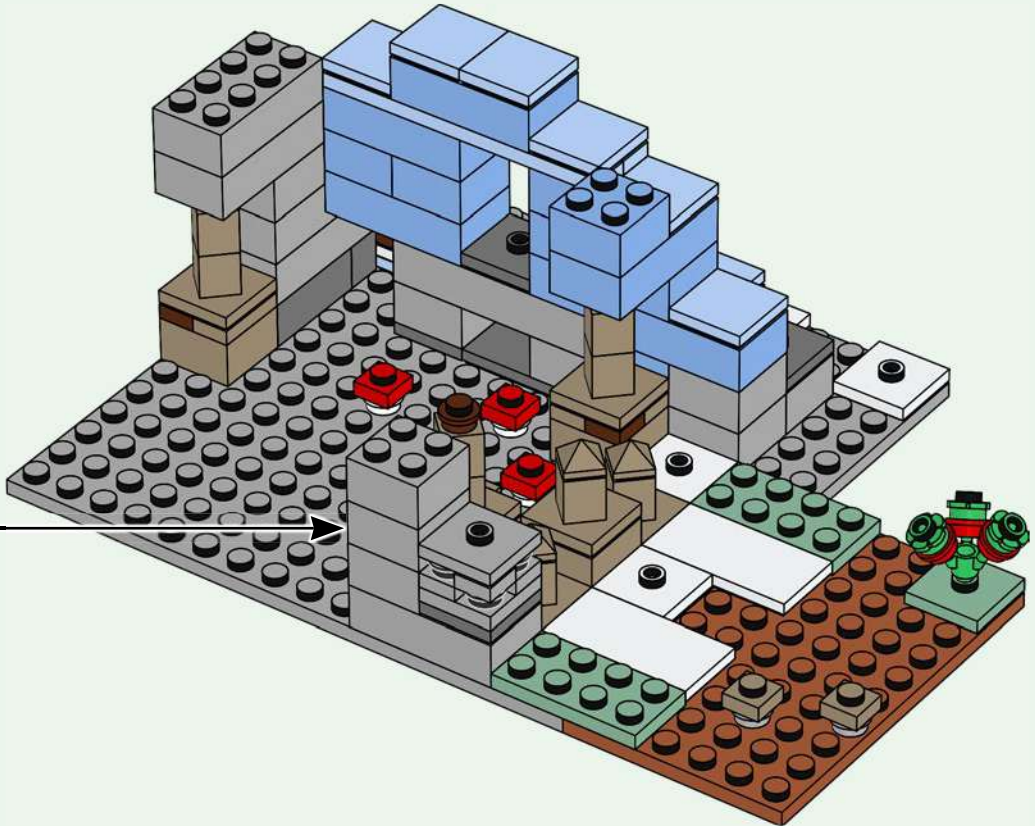
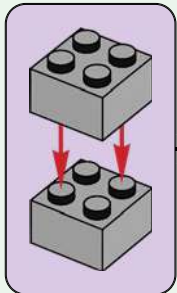

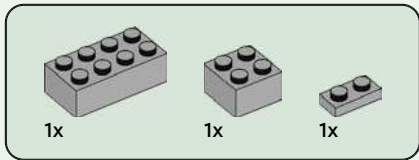

40

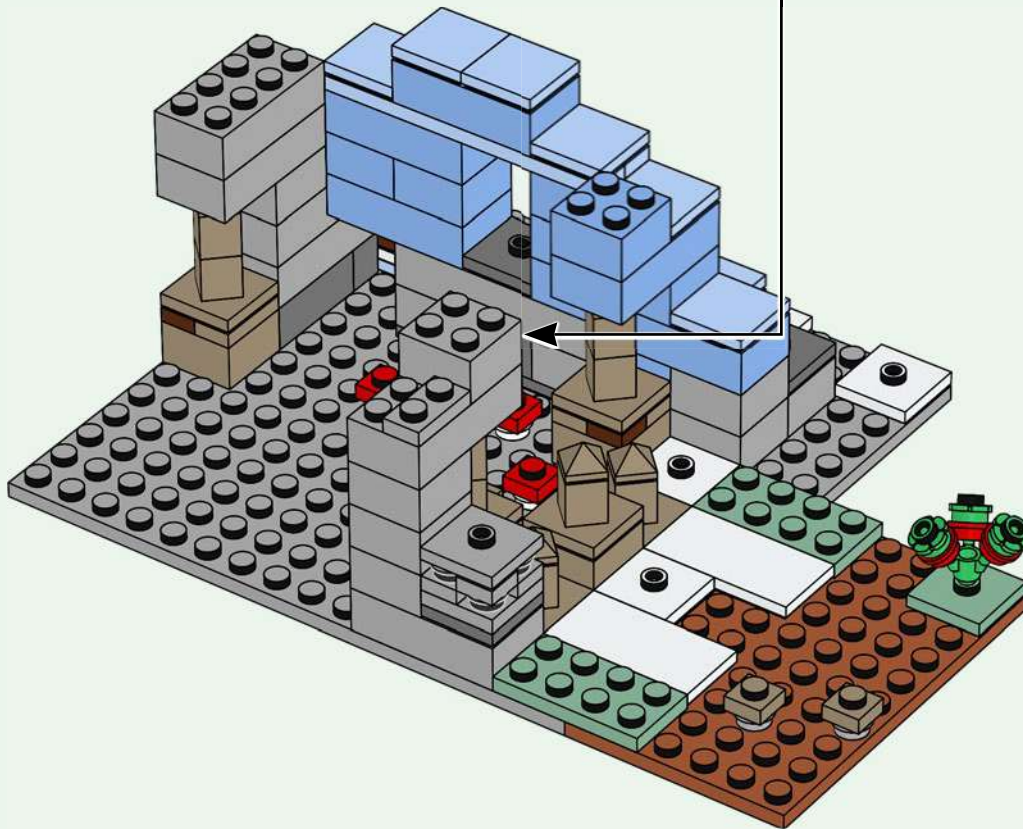
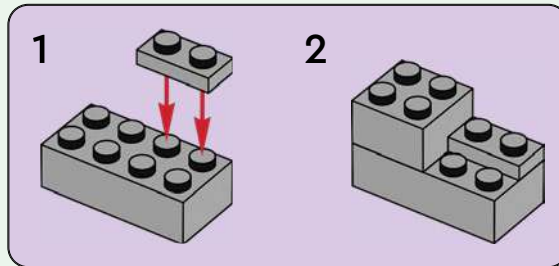

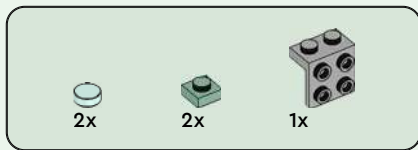

41

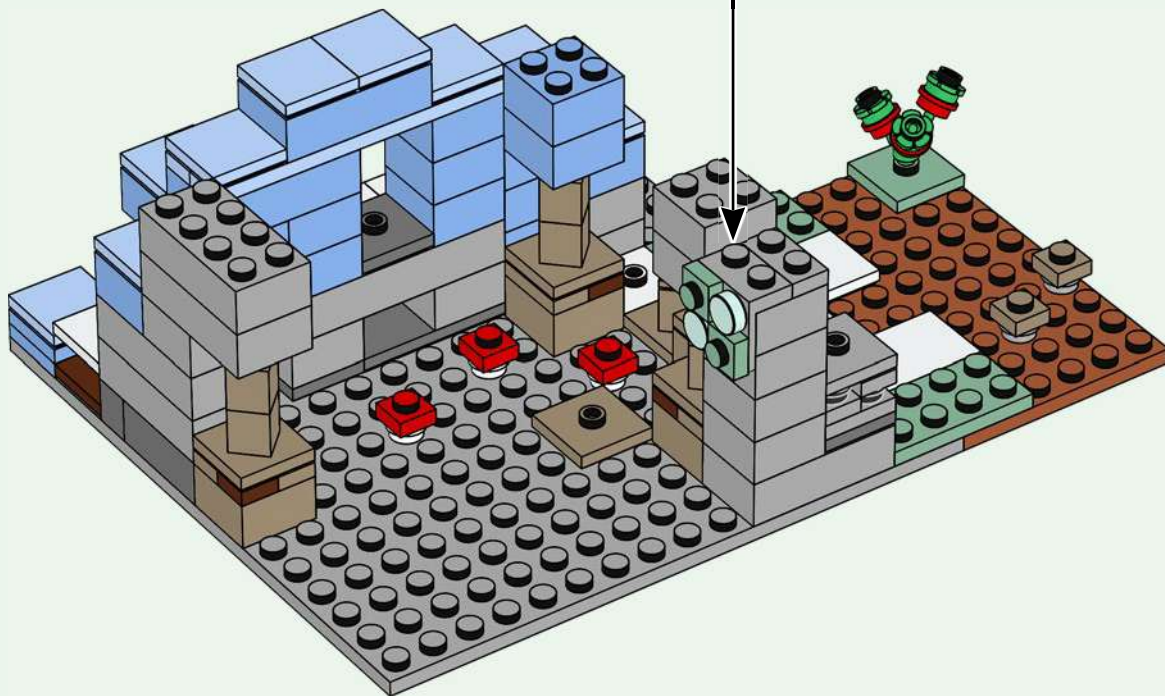
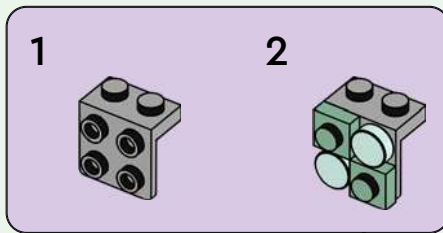



1x

42

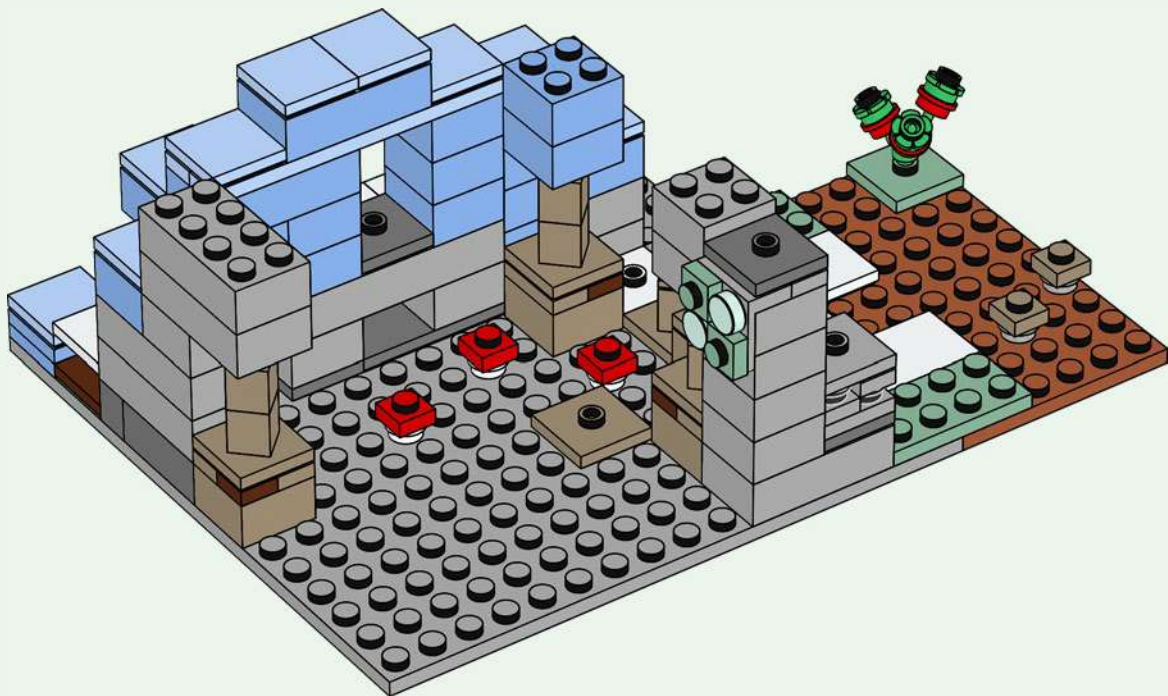



43

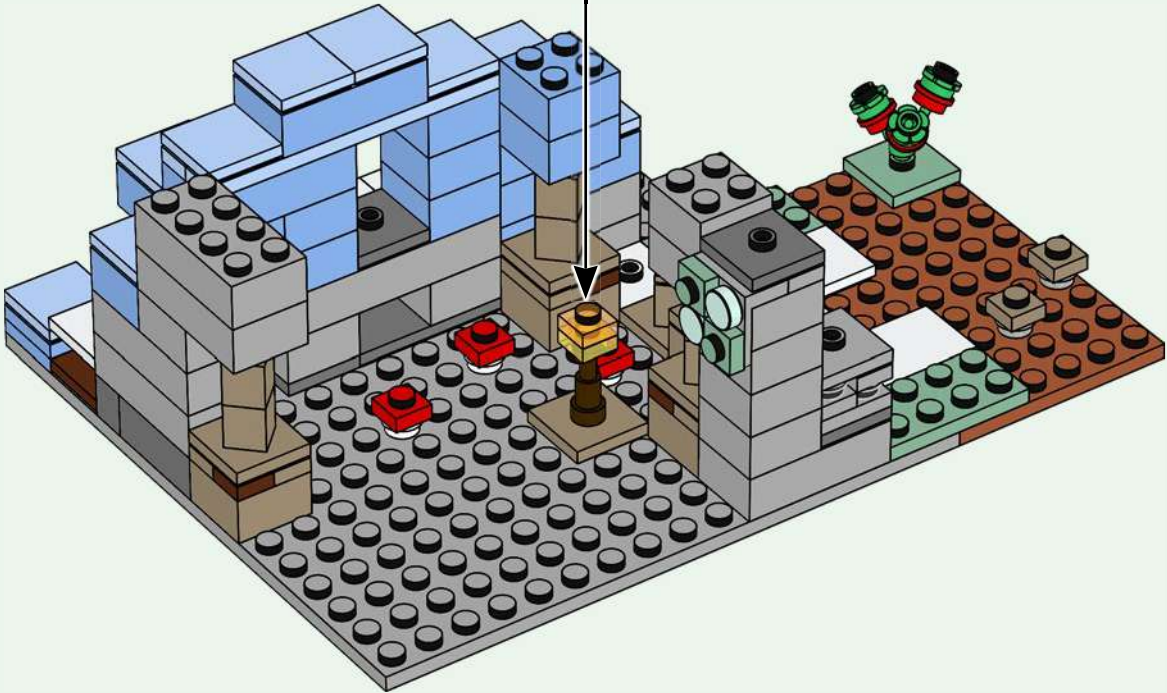
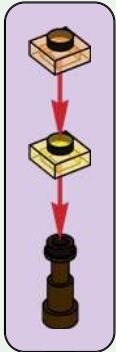



44

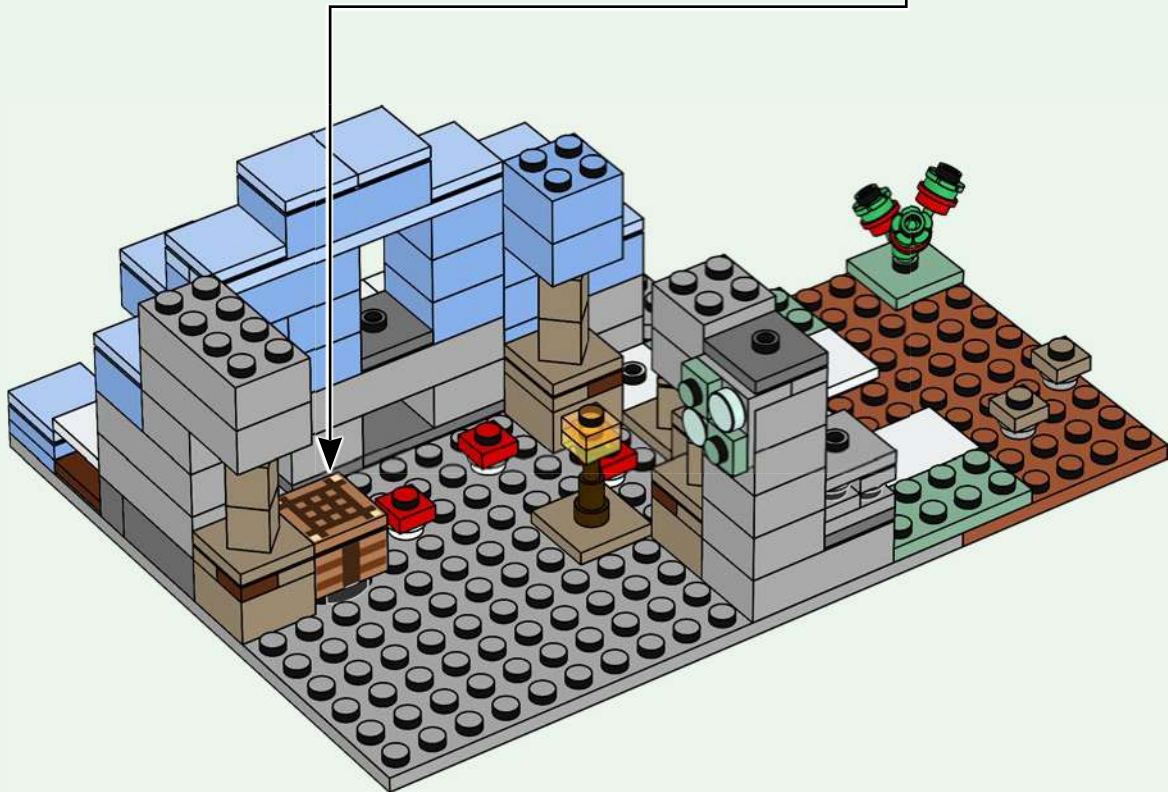
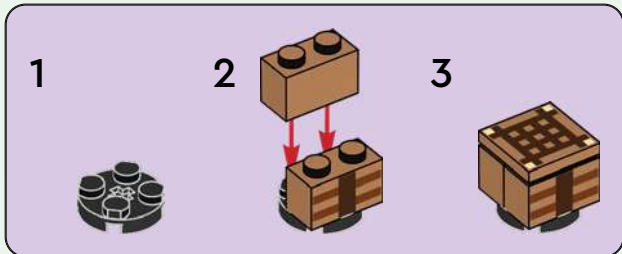

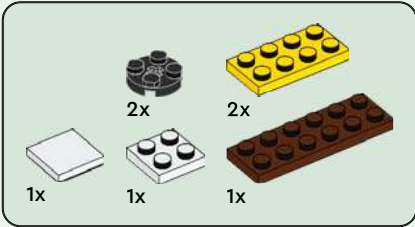

45

1



2

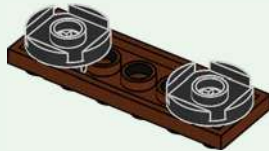

3

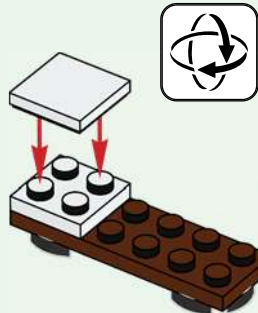

4

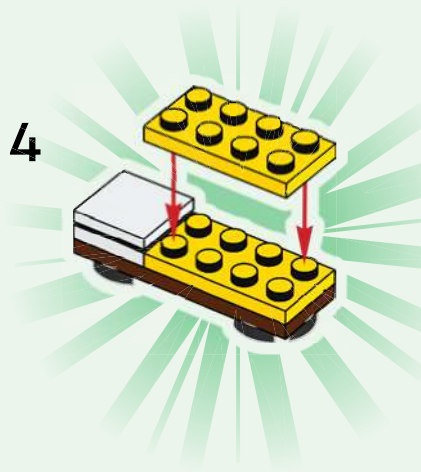

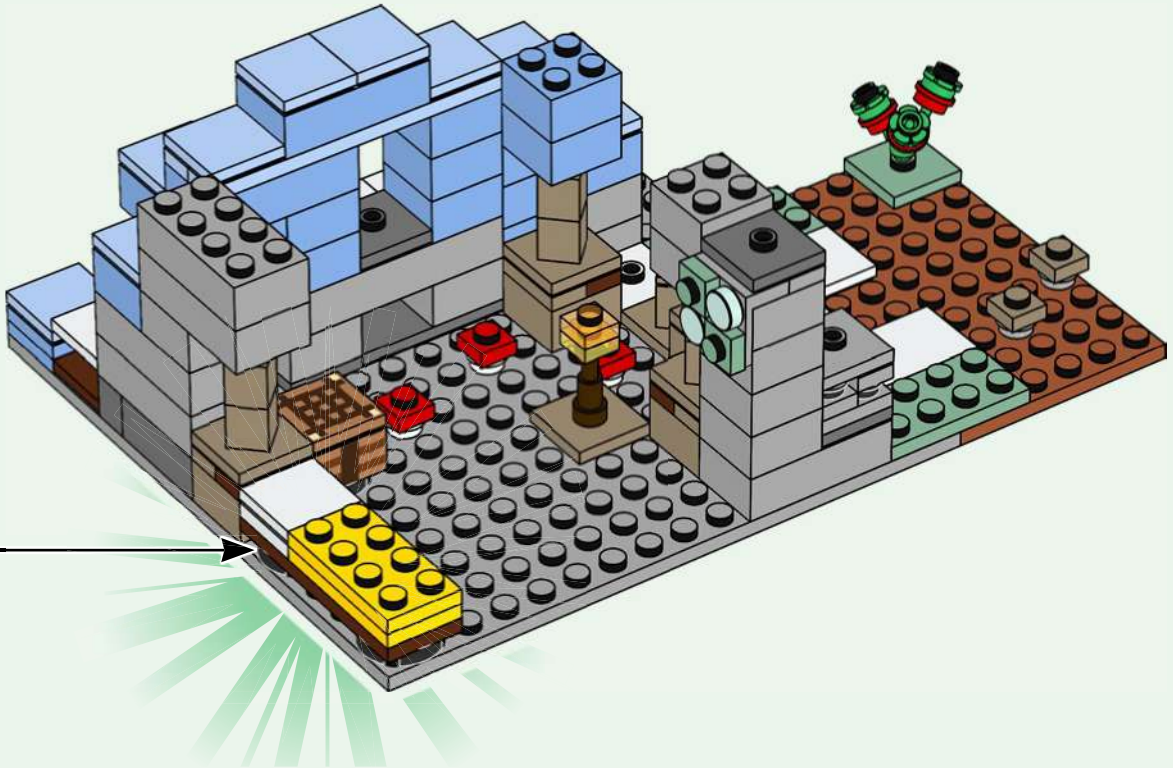



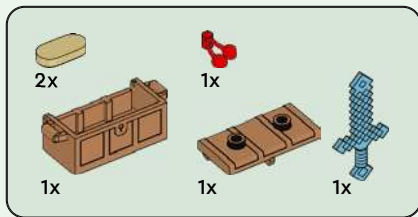

46

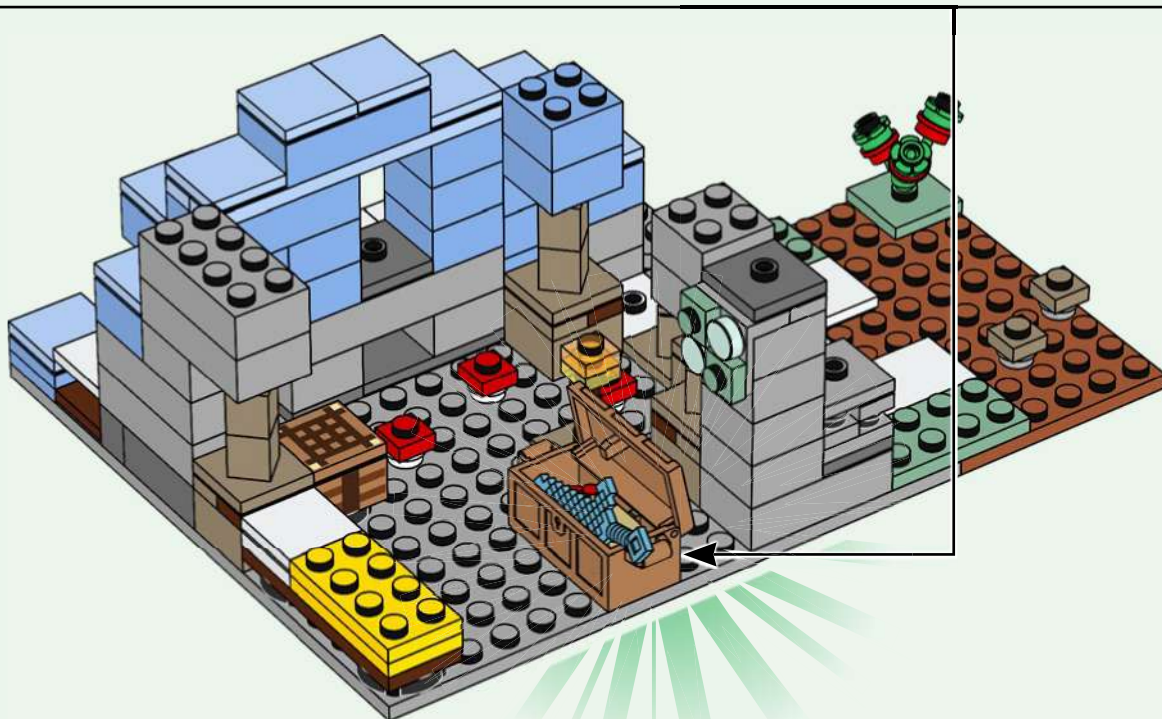
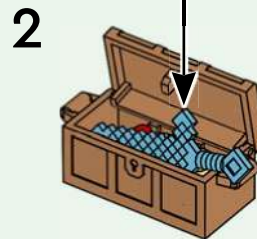
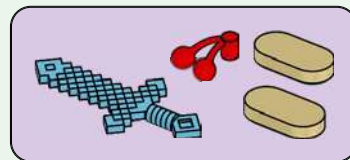
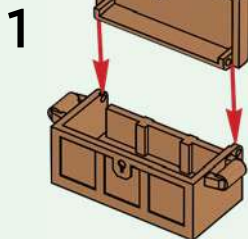

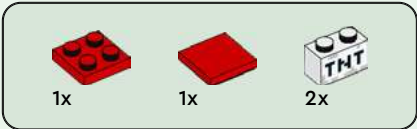

47

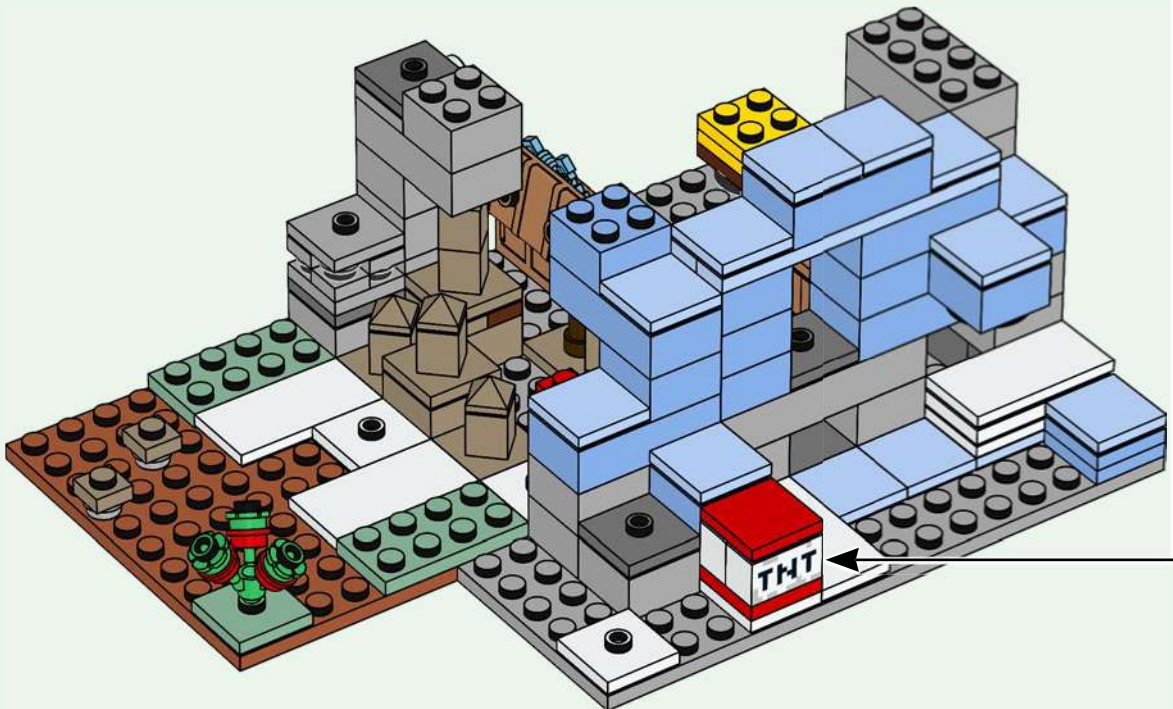
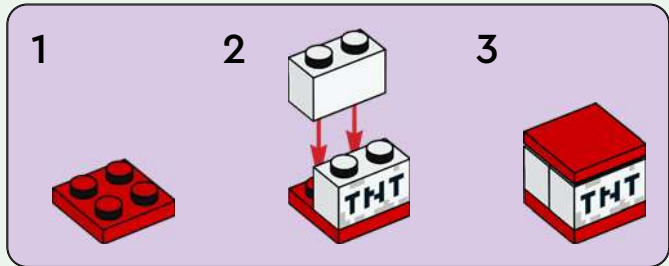
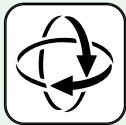

48

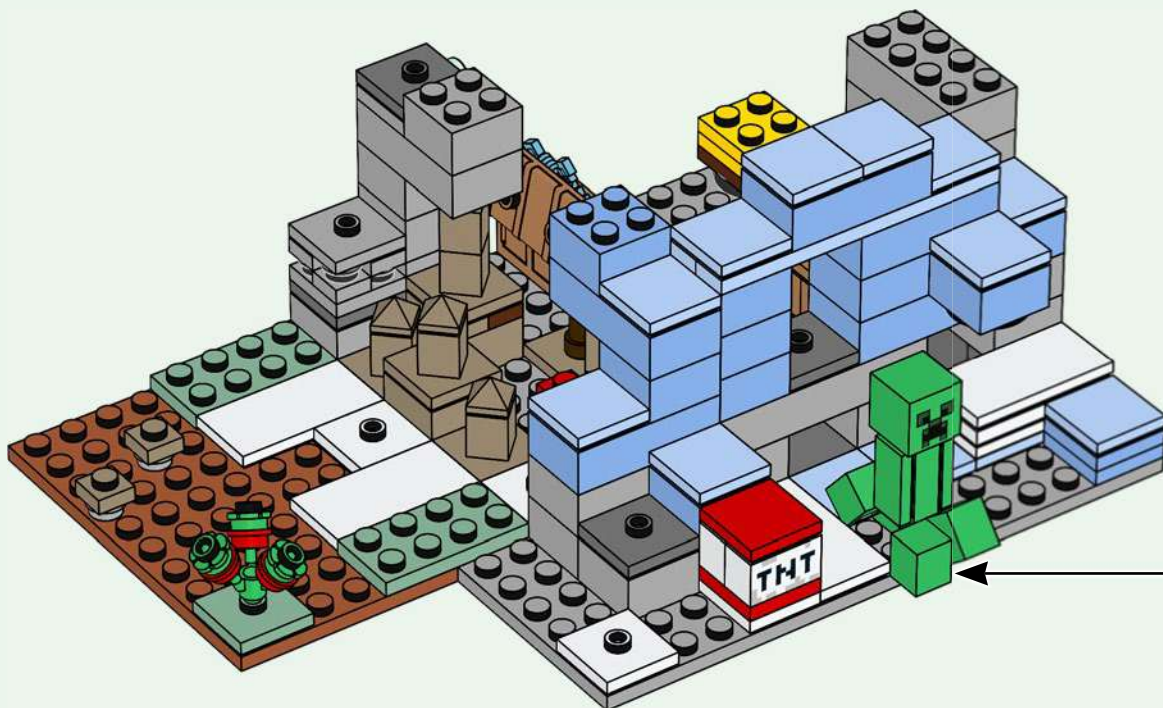
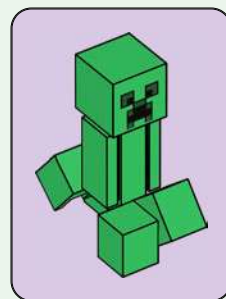

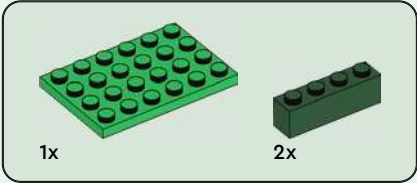
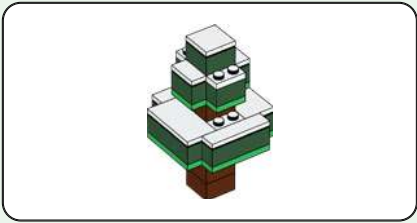

49

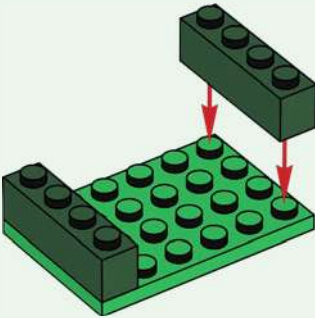

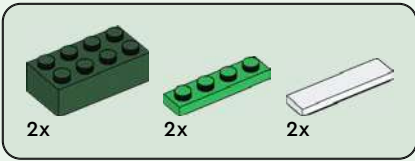

50

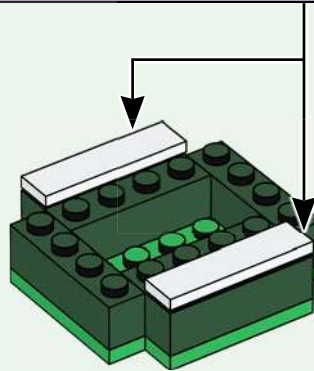
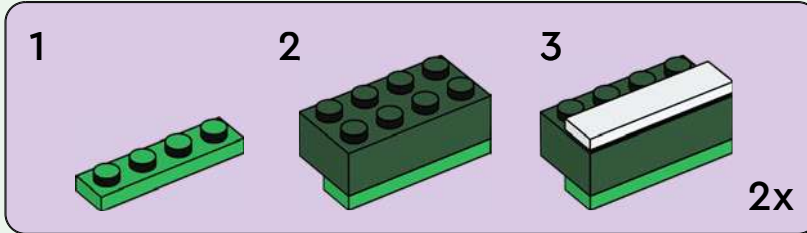

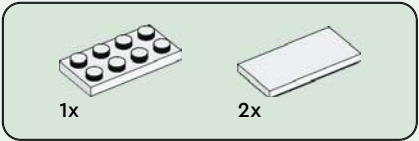

51

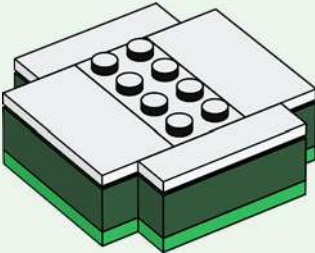



1x

52

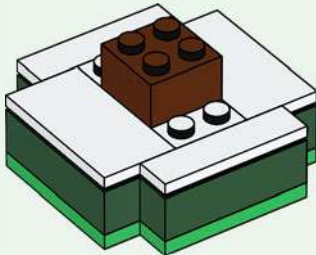

1x



2x

53

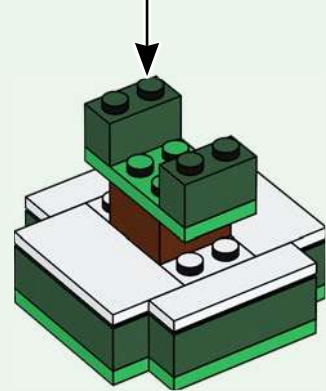
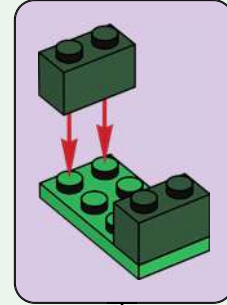

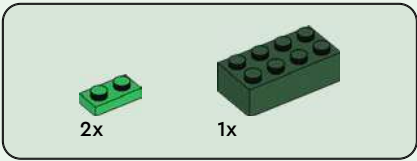

# 54

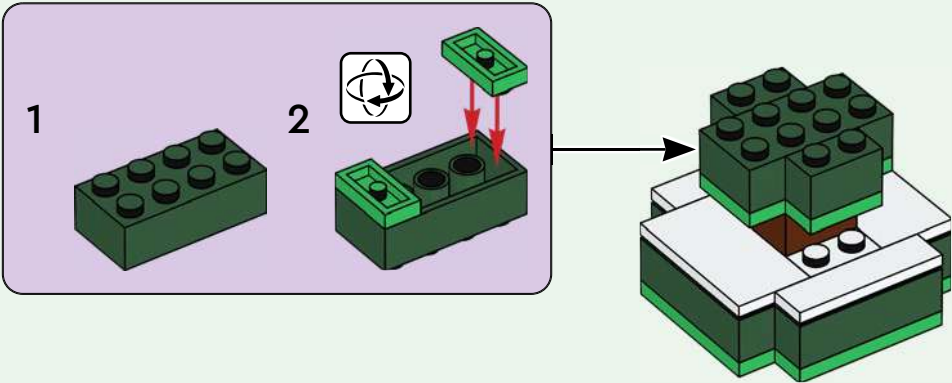



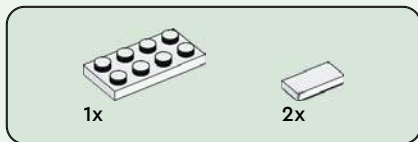

55

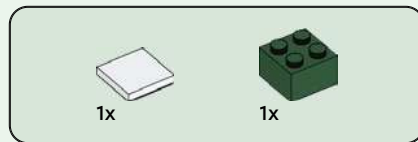
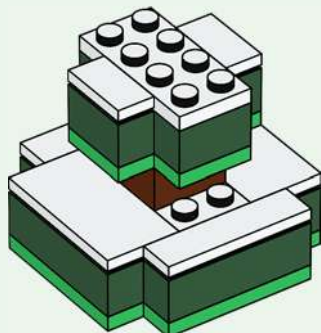

56

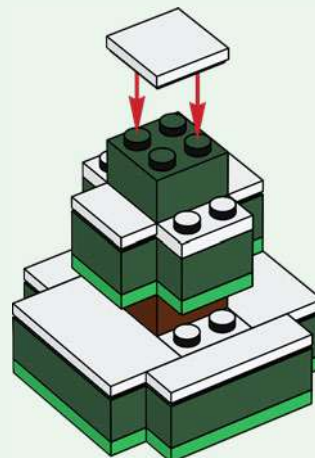



3x

57

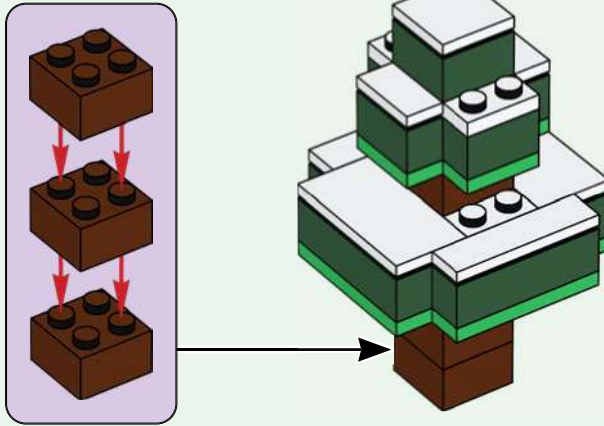

58

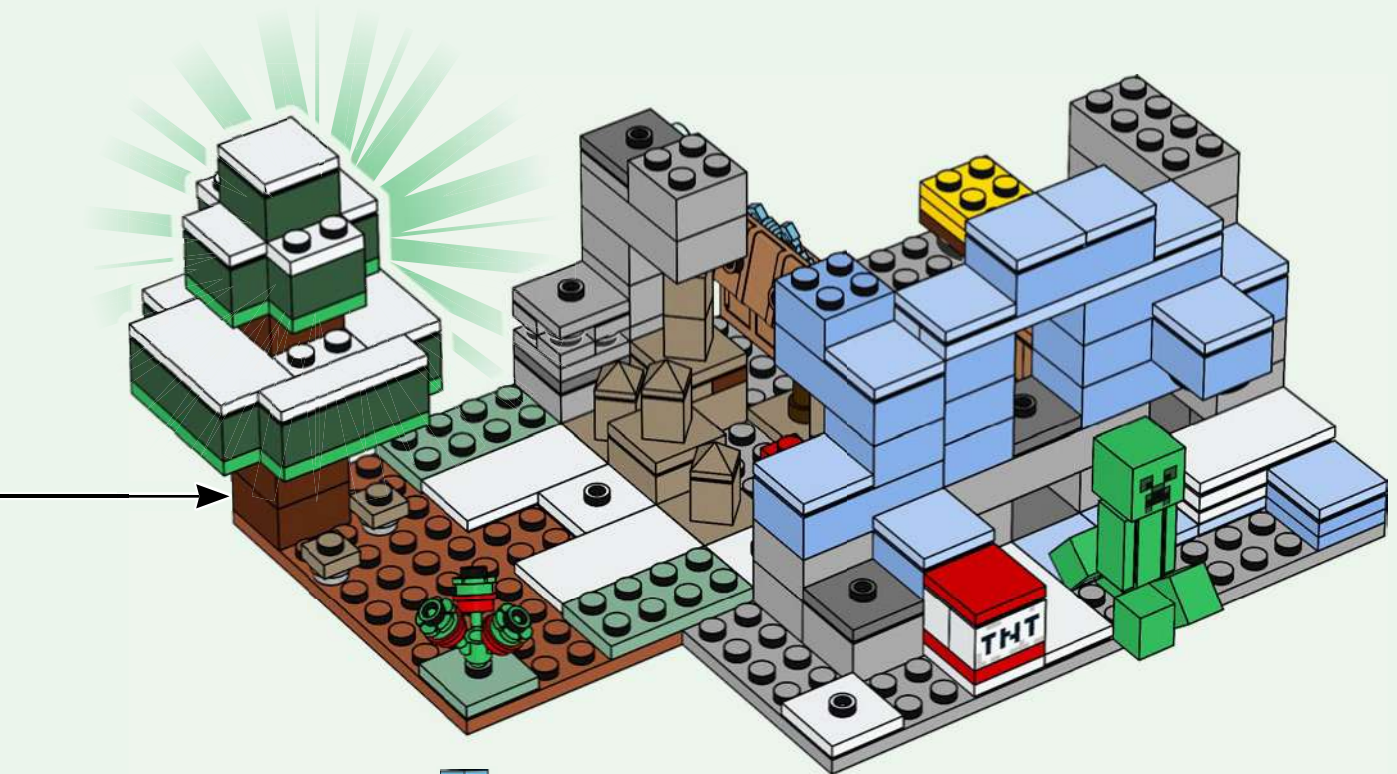



1



2

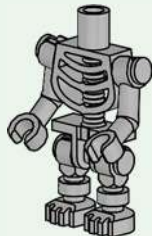

3

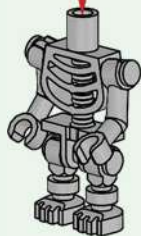

4

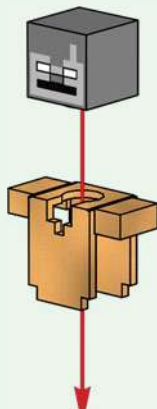
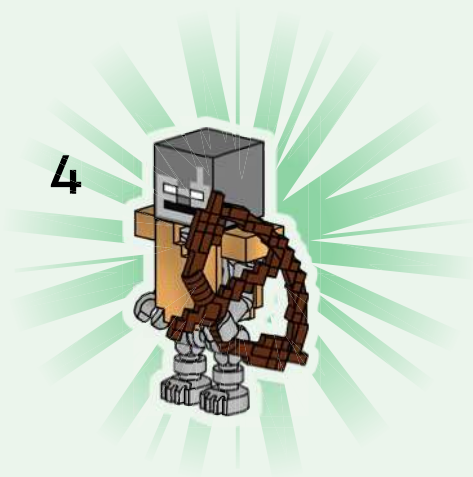

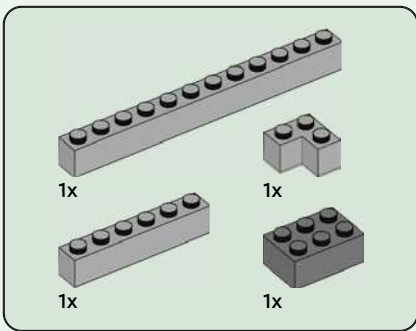

59

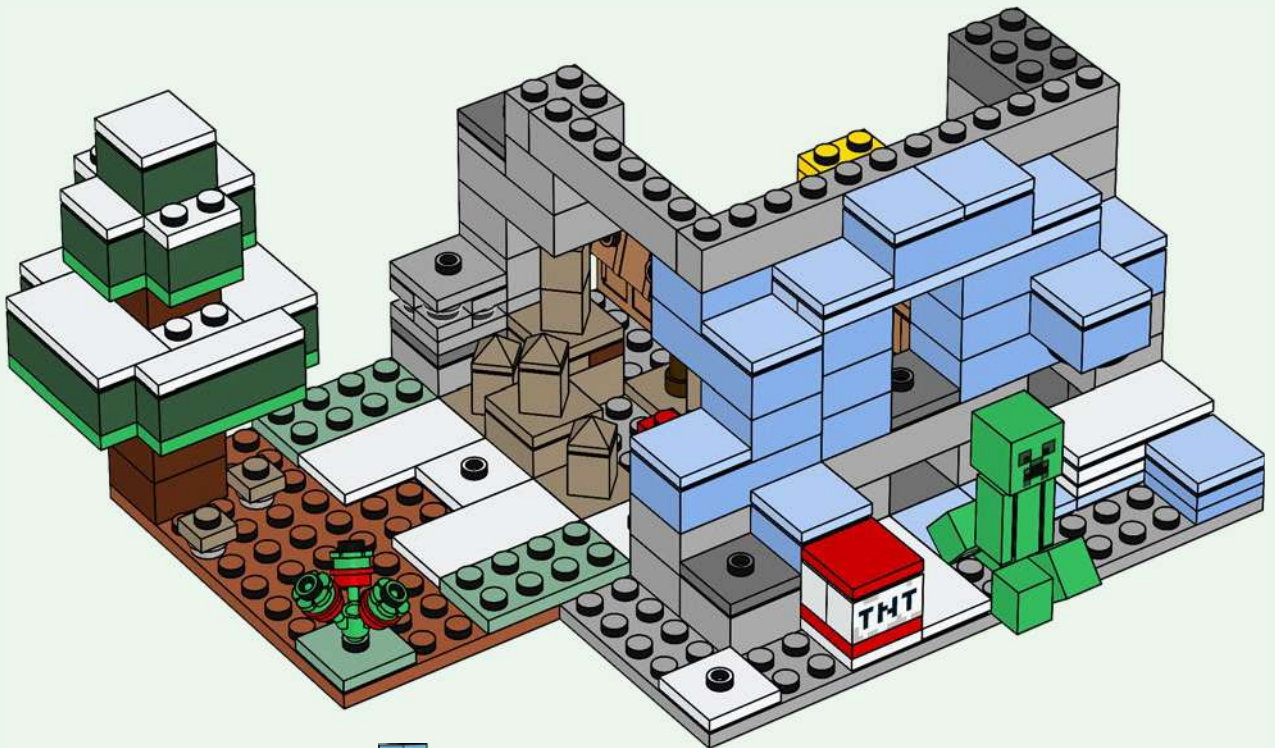

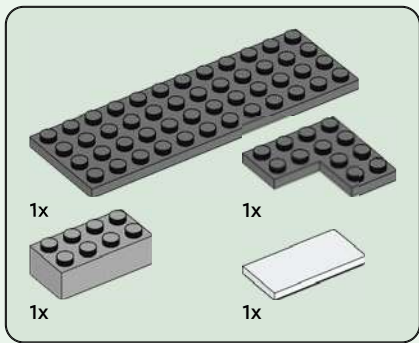

60

1

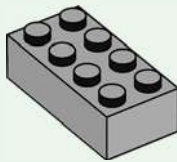

2

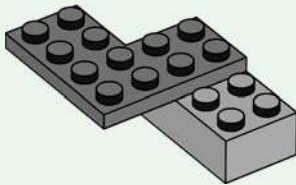

3

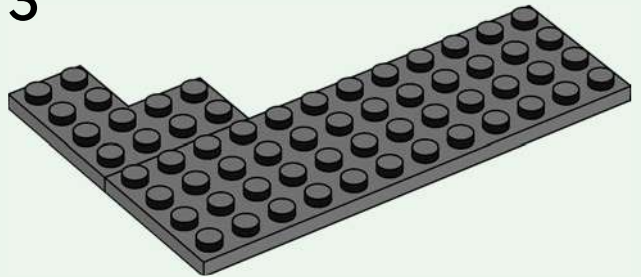

4

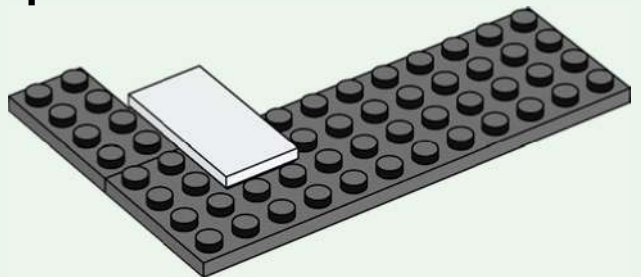

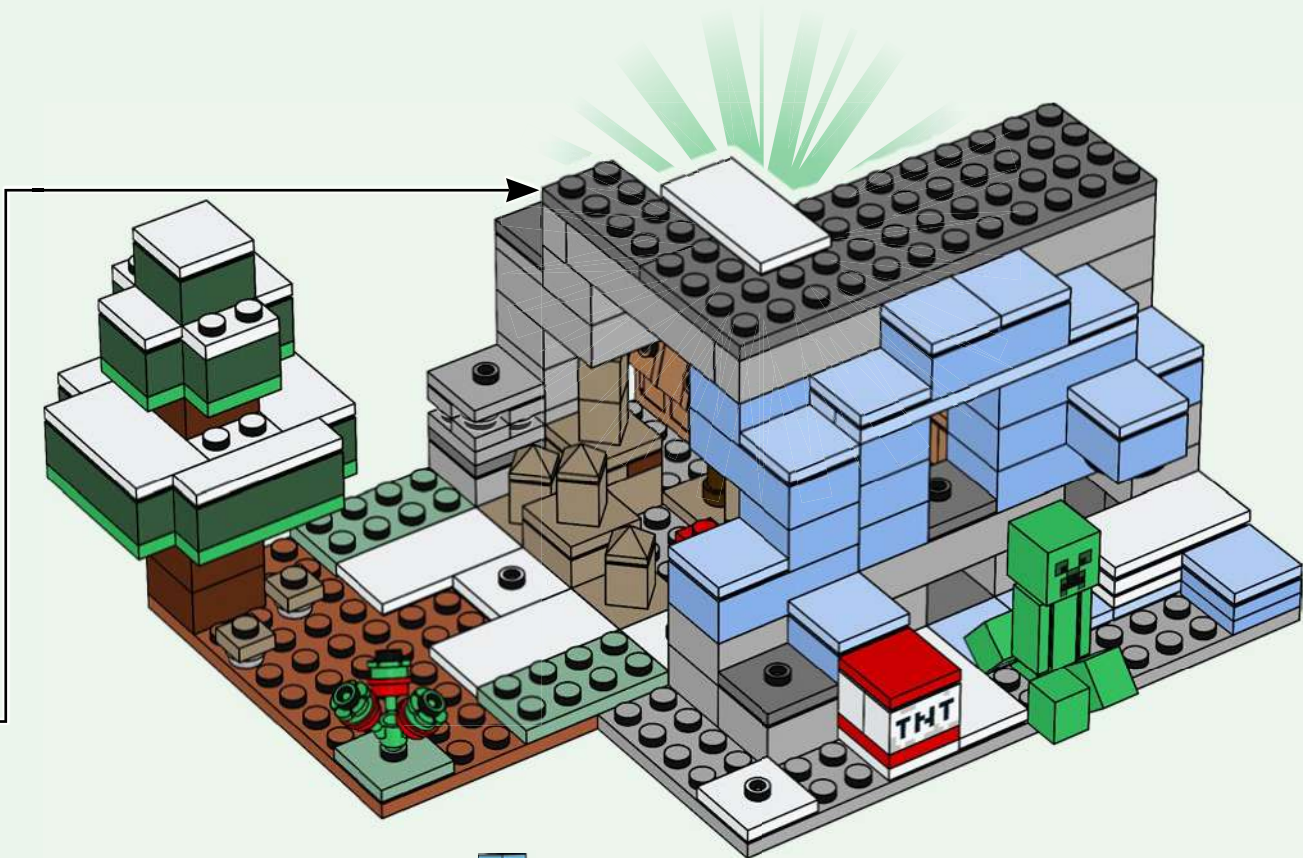

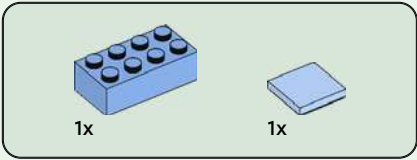

61

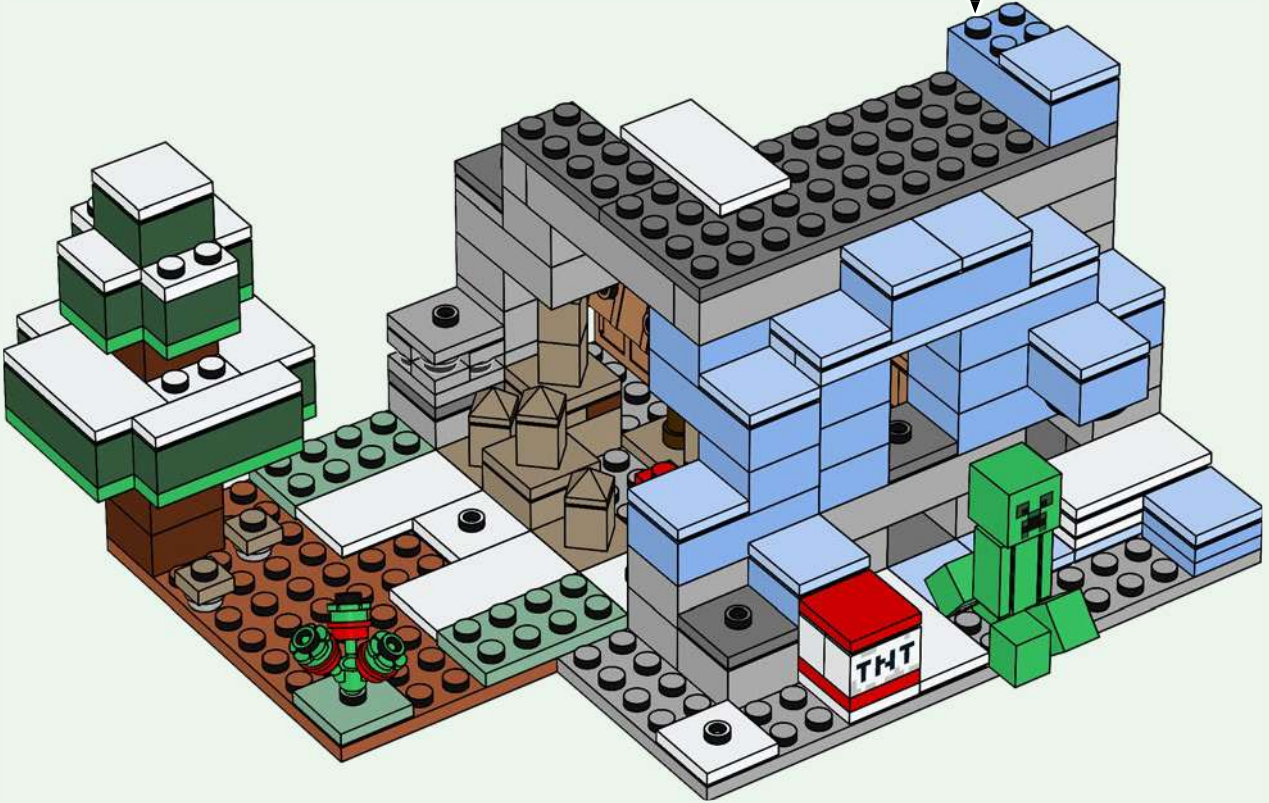
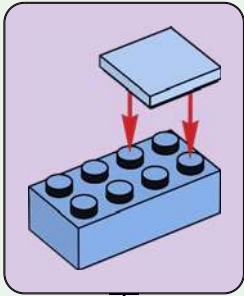



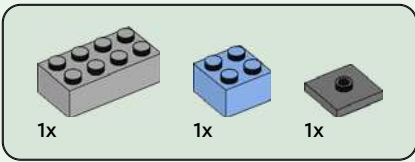

62

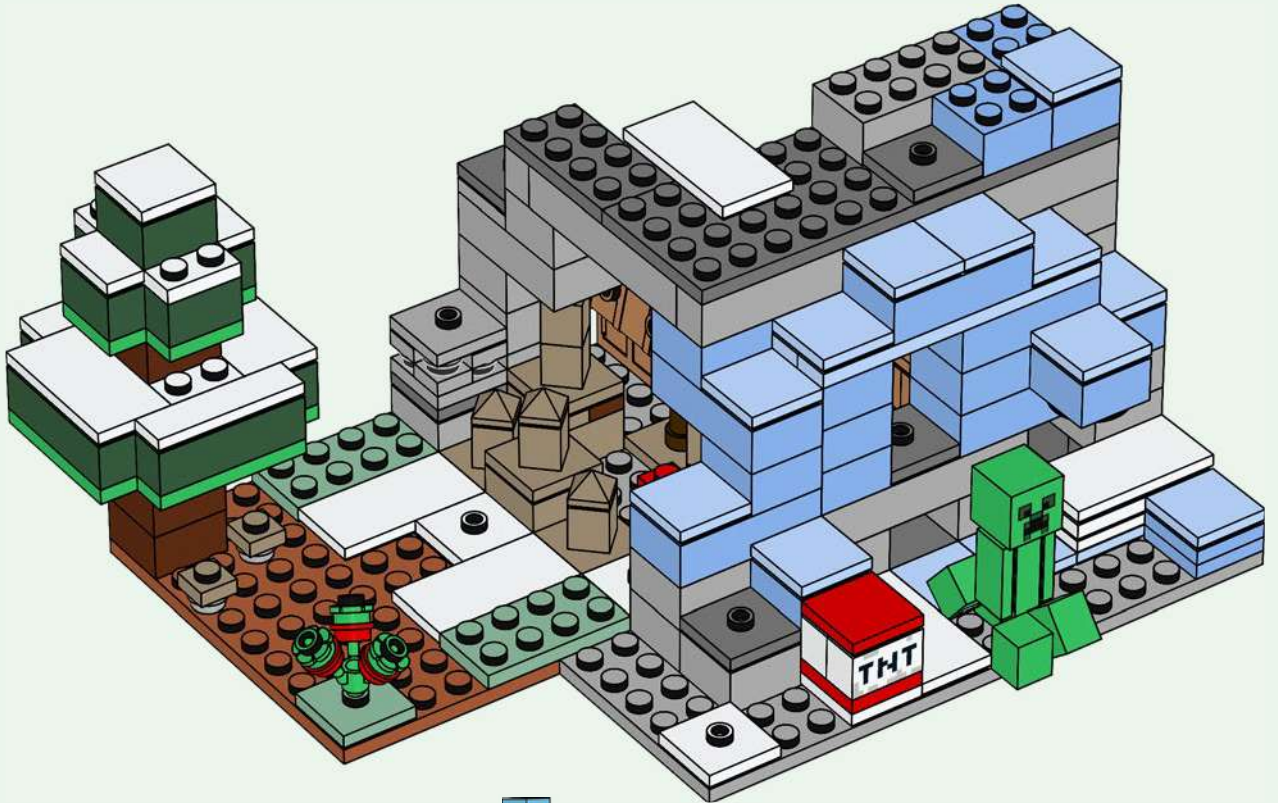

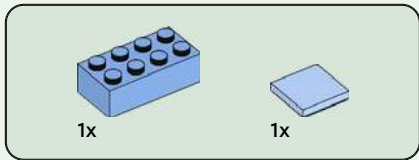

63

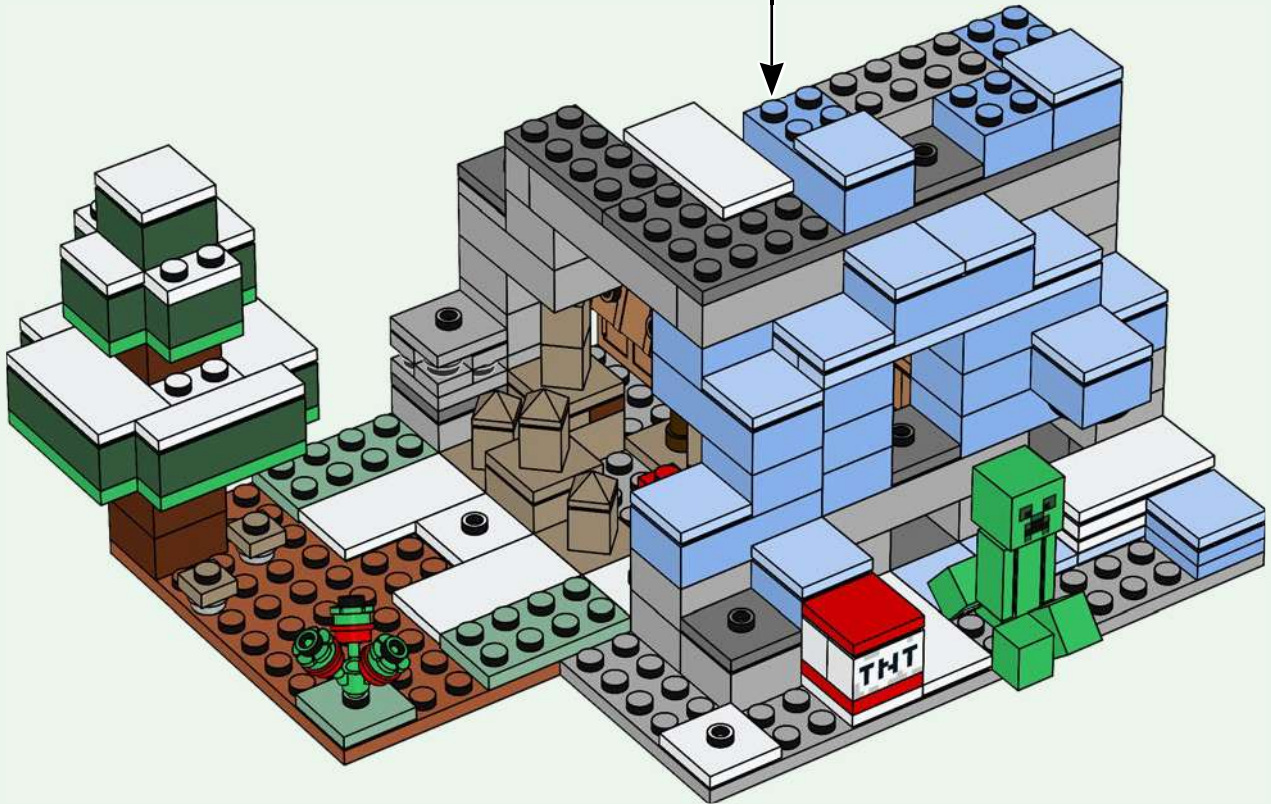
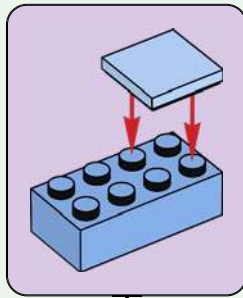



2x

64

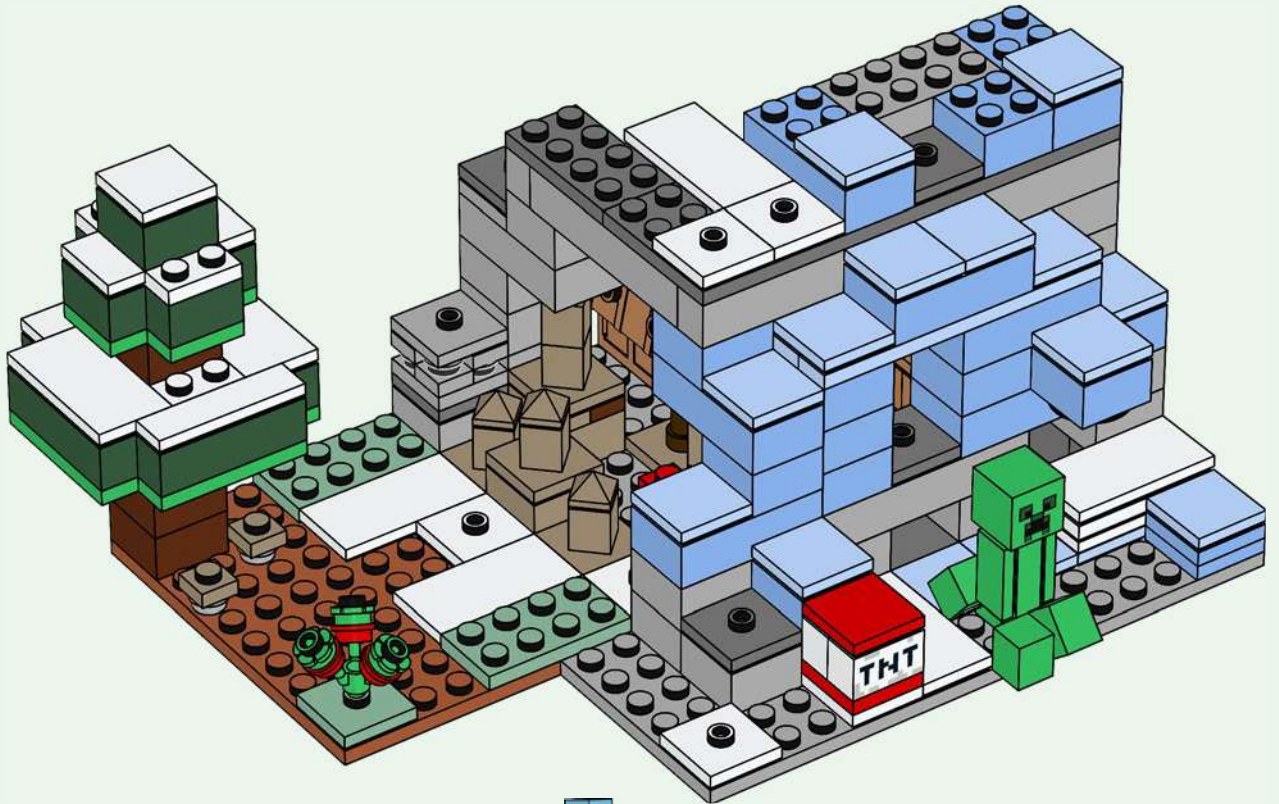

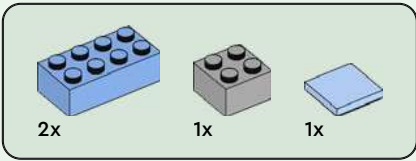

65

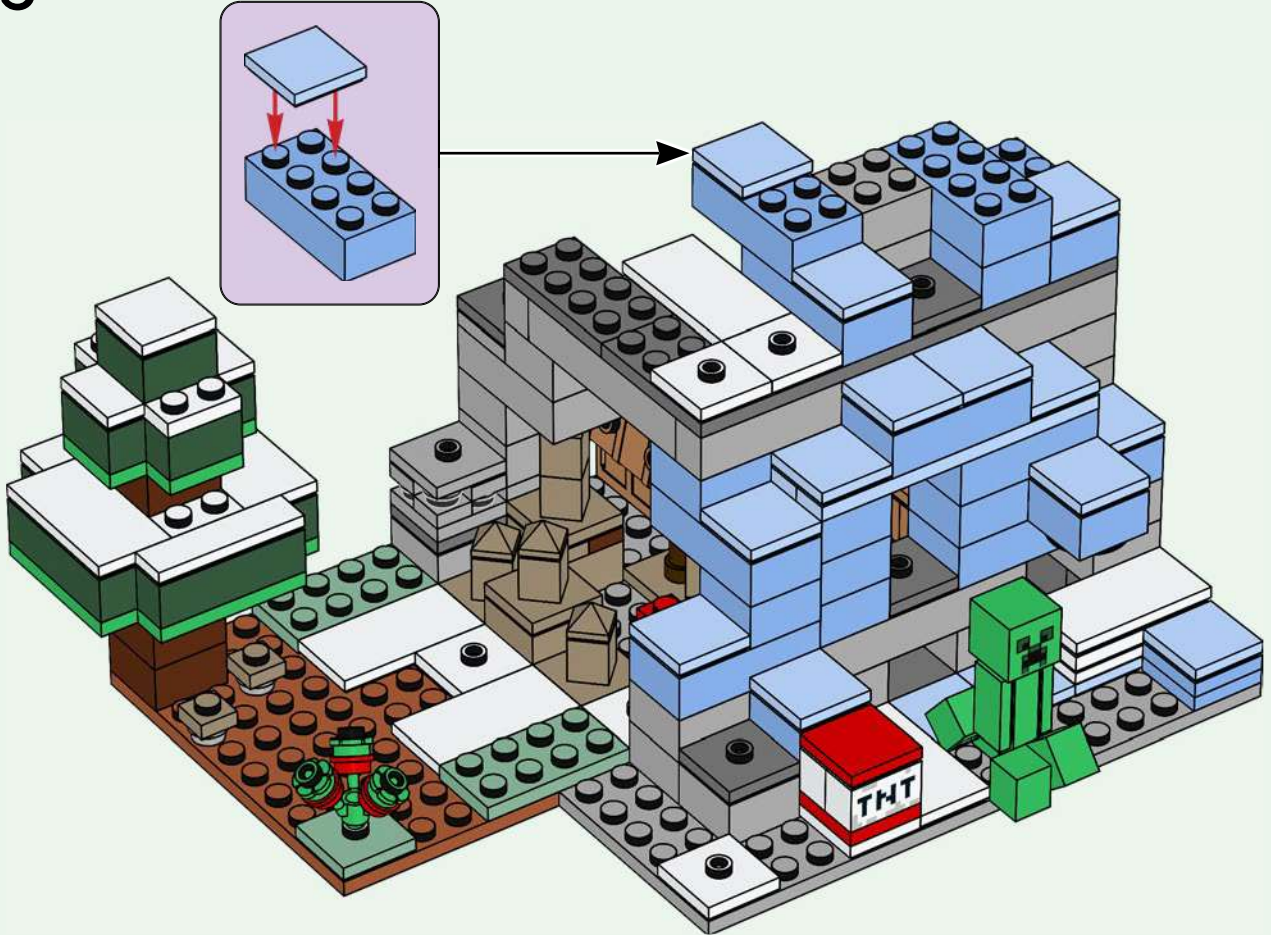

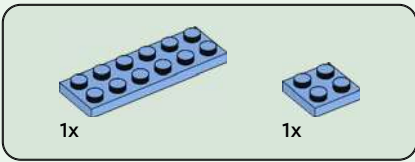

66

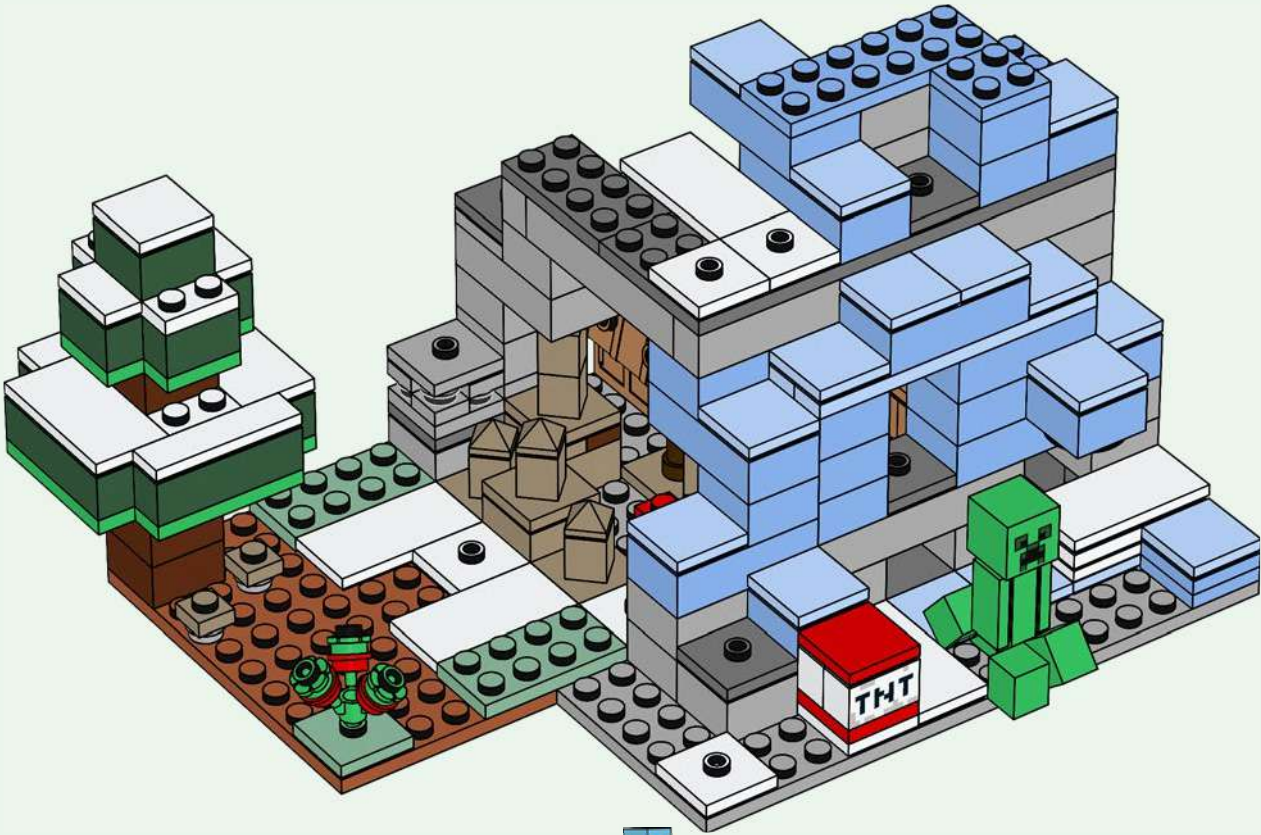

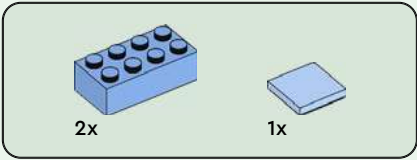

67

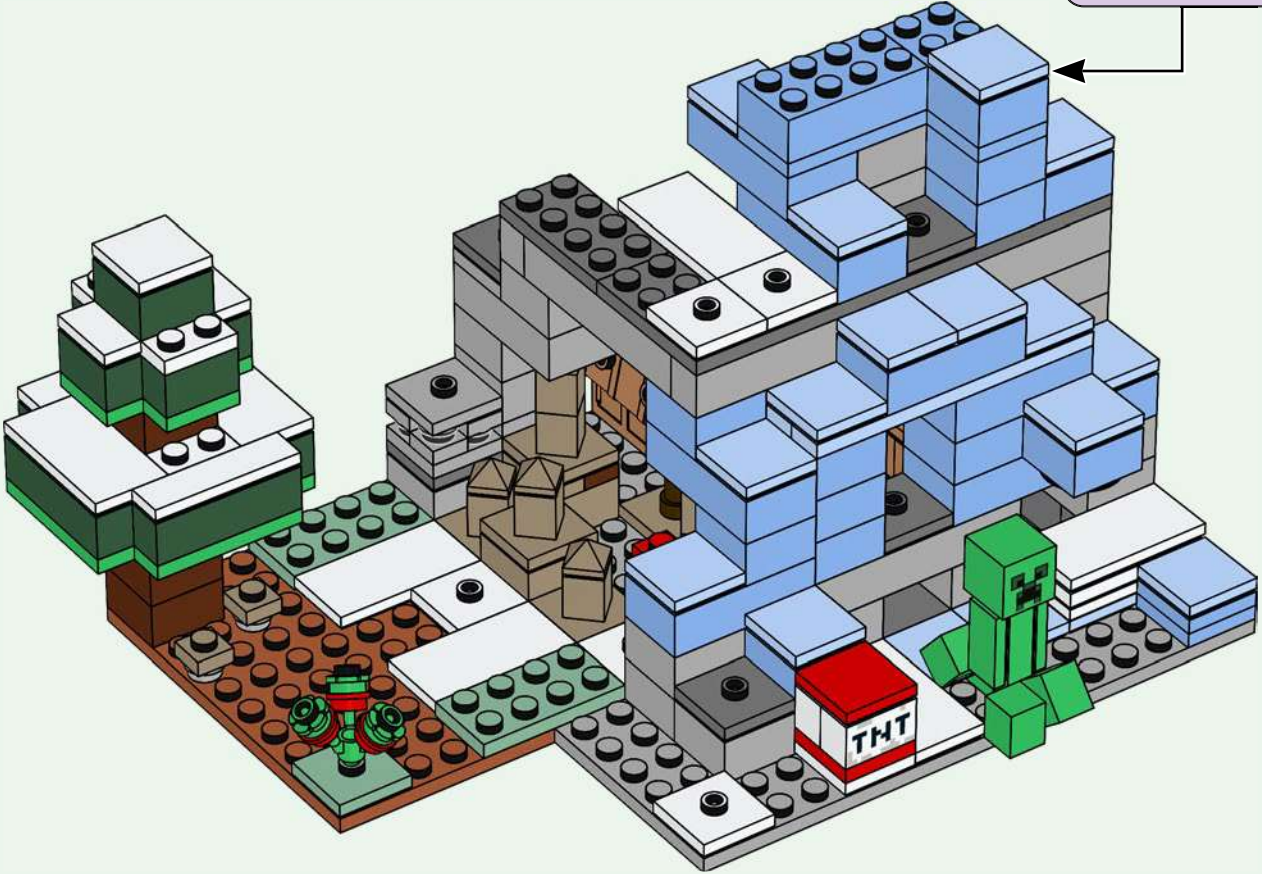
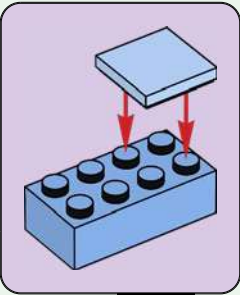



1x

68

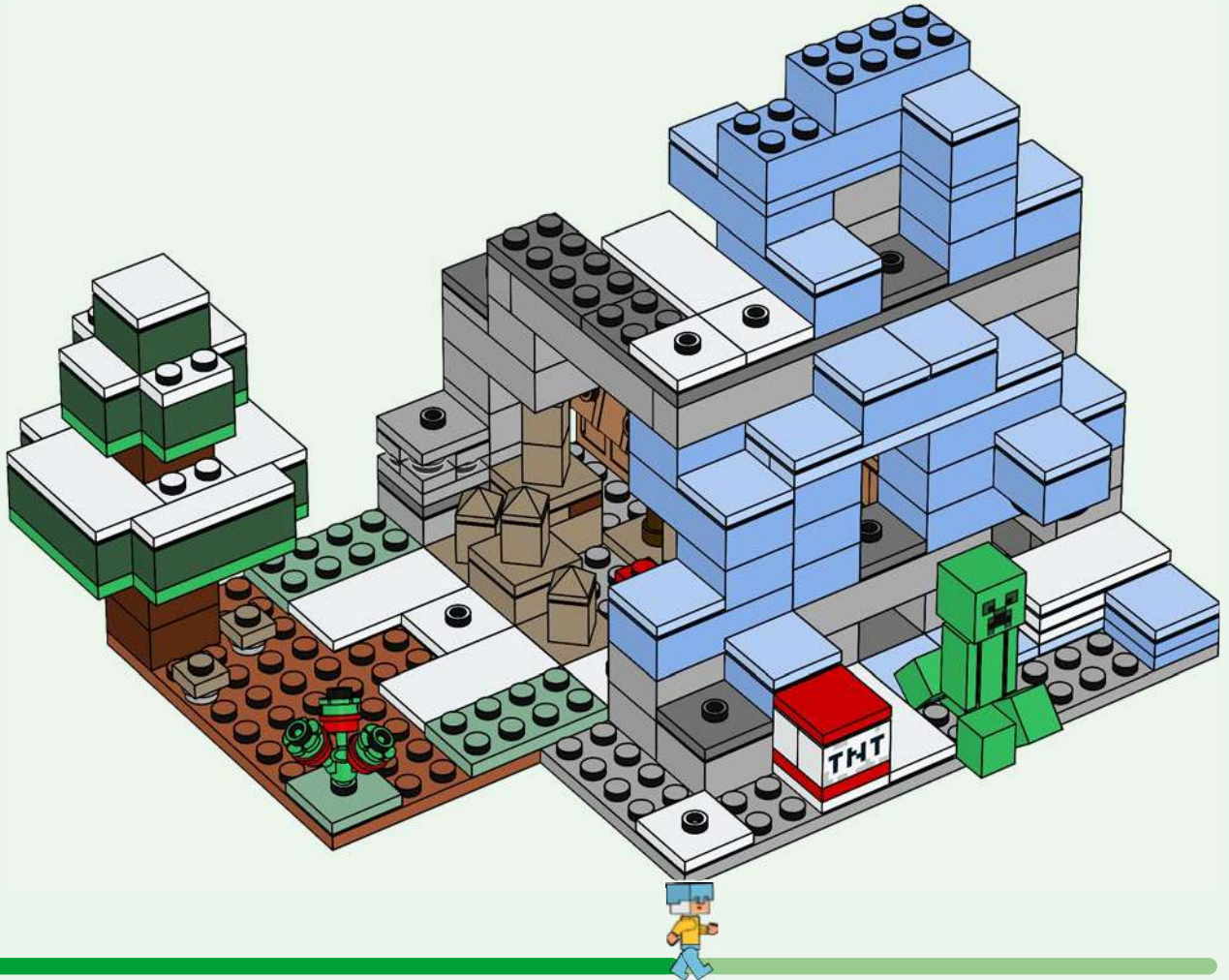



3x

69

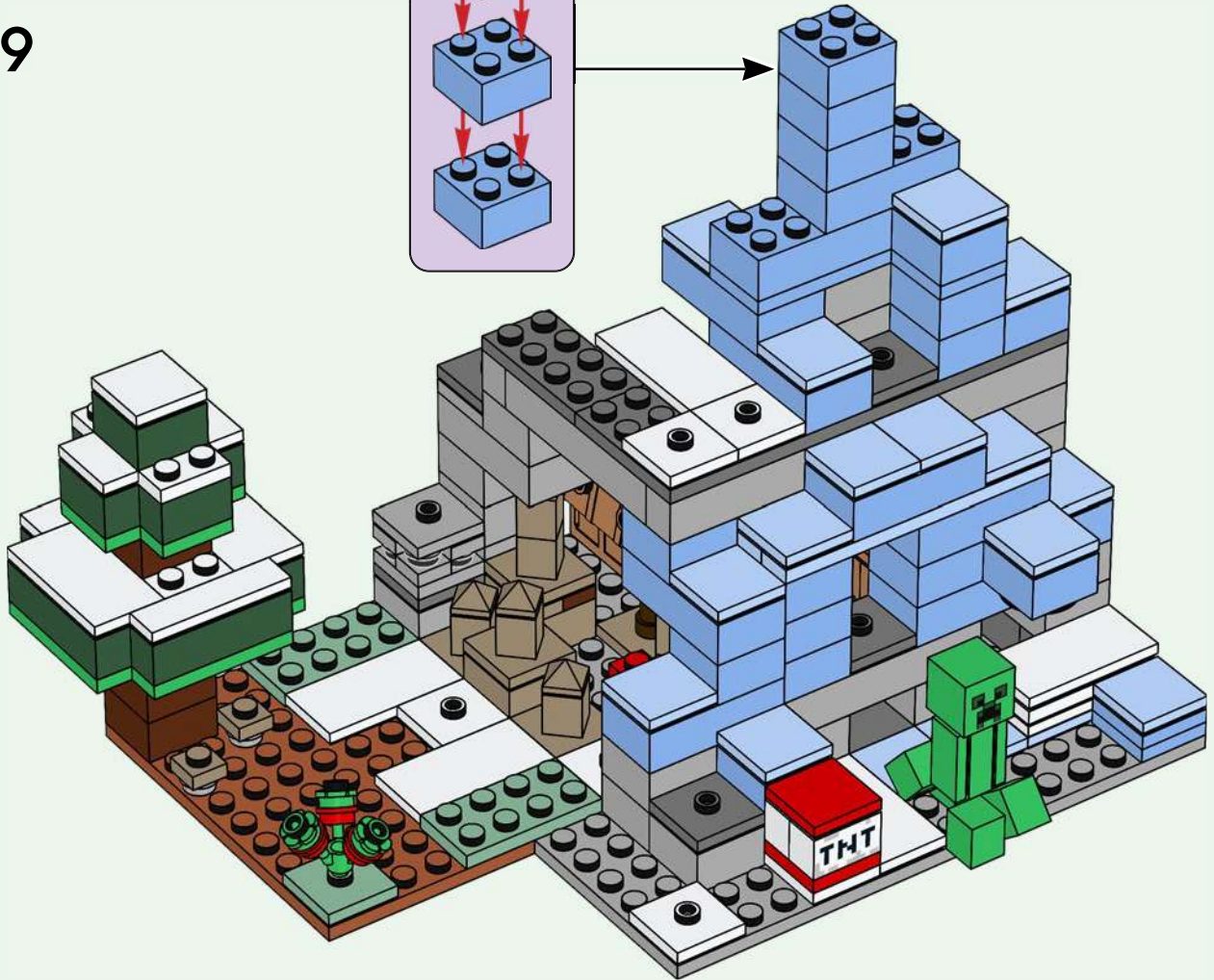
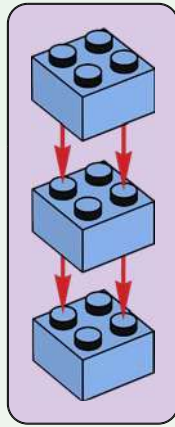



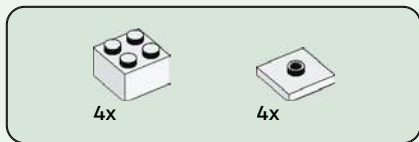

70

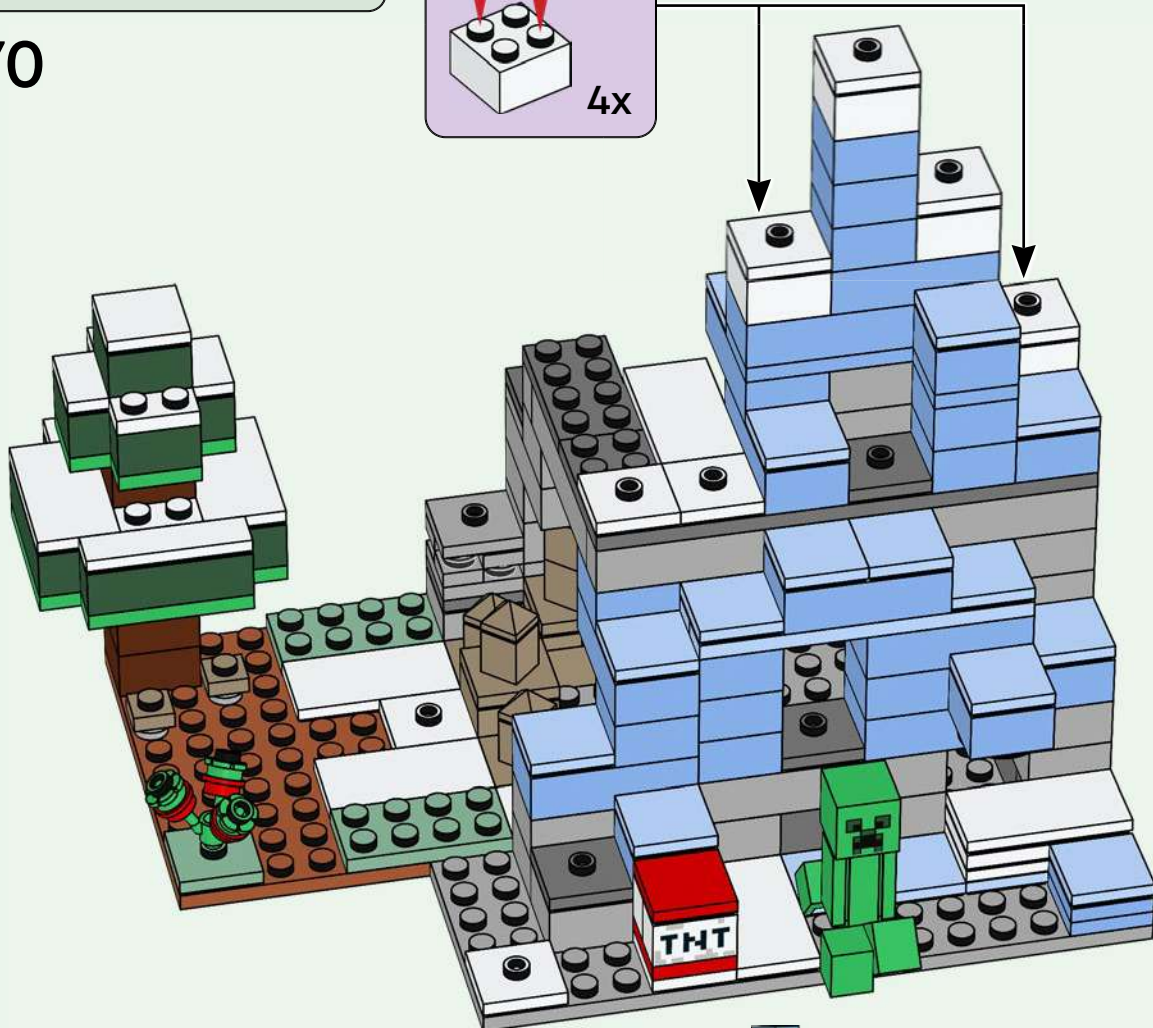
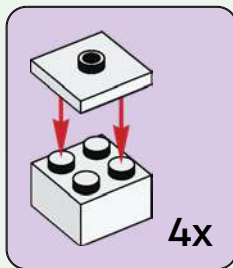

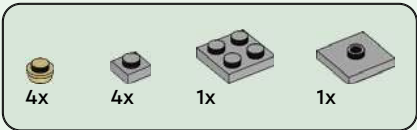

71

1



2

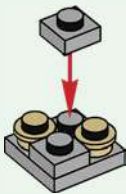

3

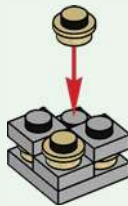

4

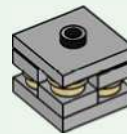

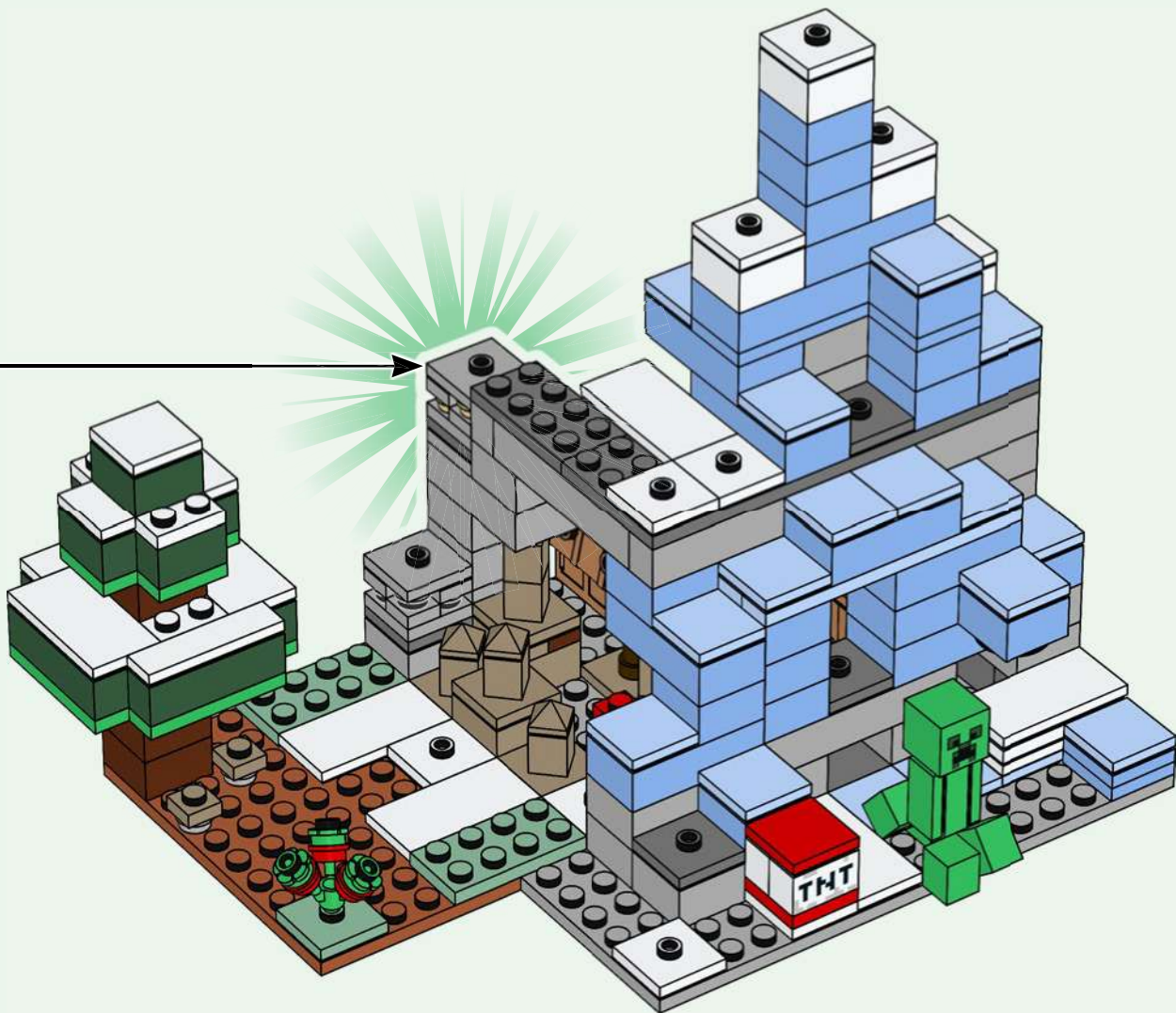

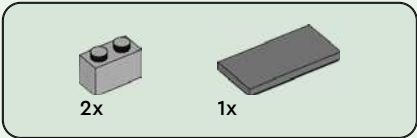

72





1x

73



3x

74

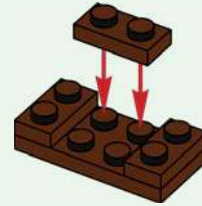



75

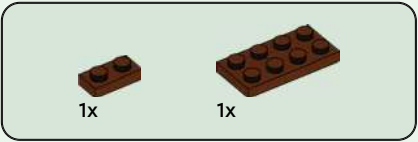
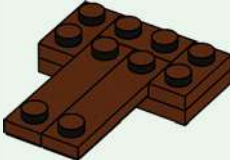

76

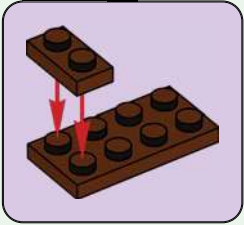
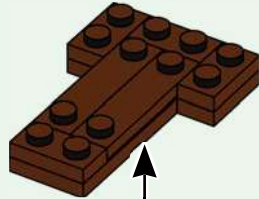



1x



1x

# 77

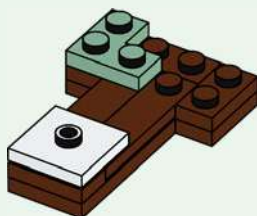

1x



2x

# 78

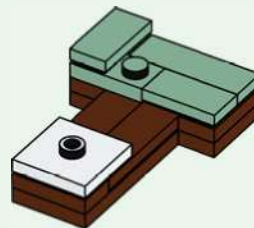

79

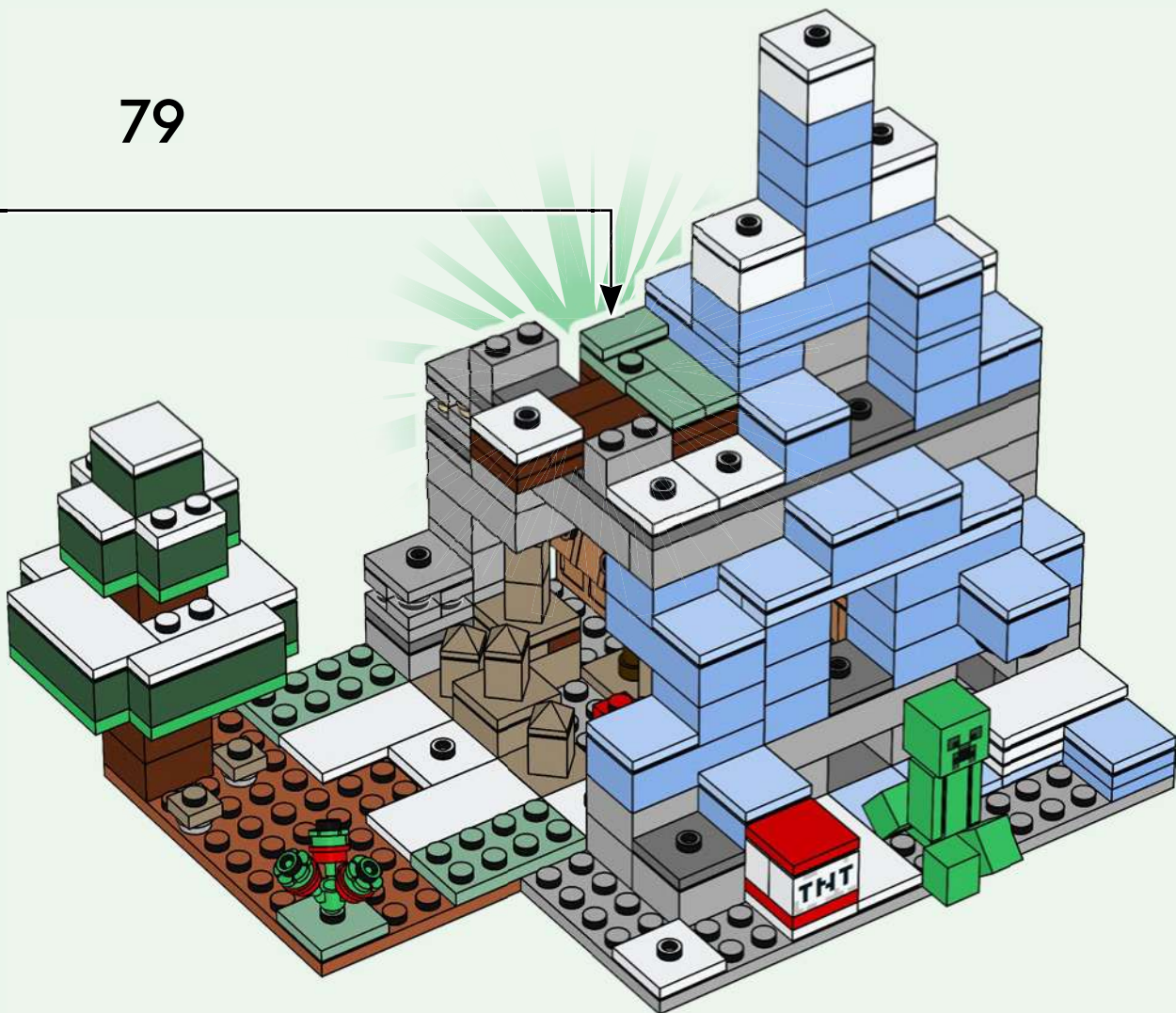





1x

80

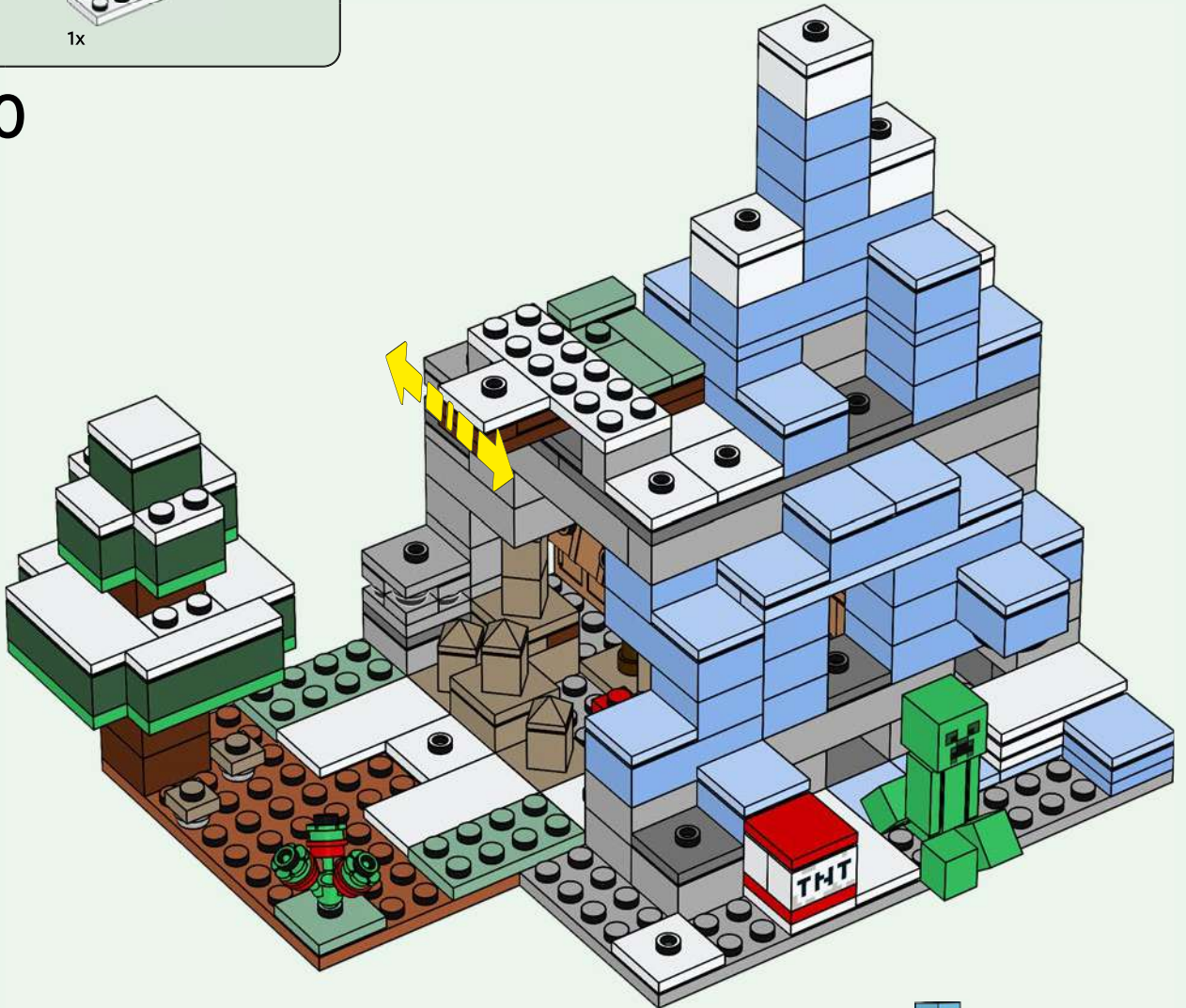

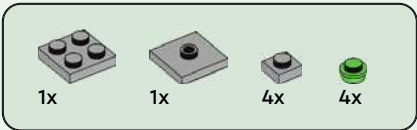

81

1



2

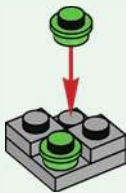

3

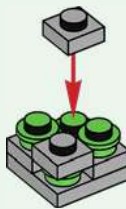

4

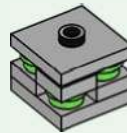

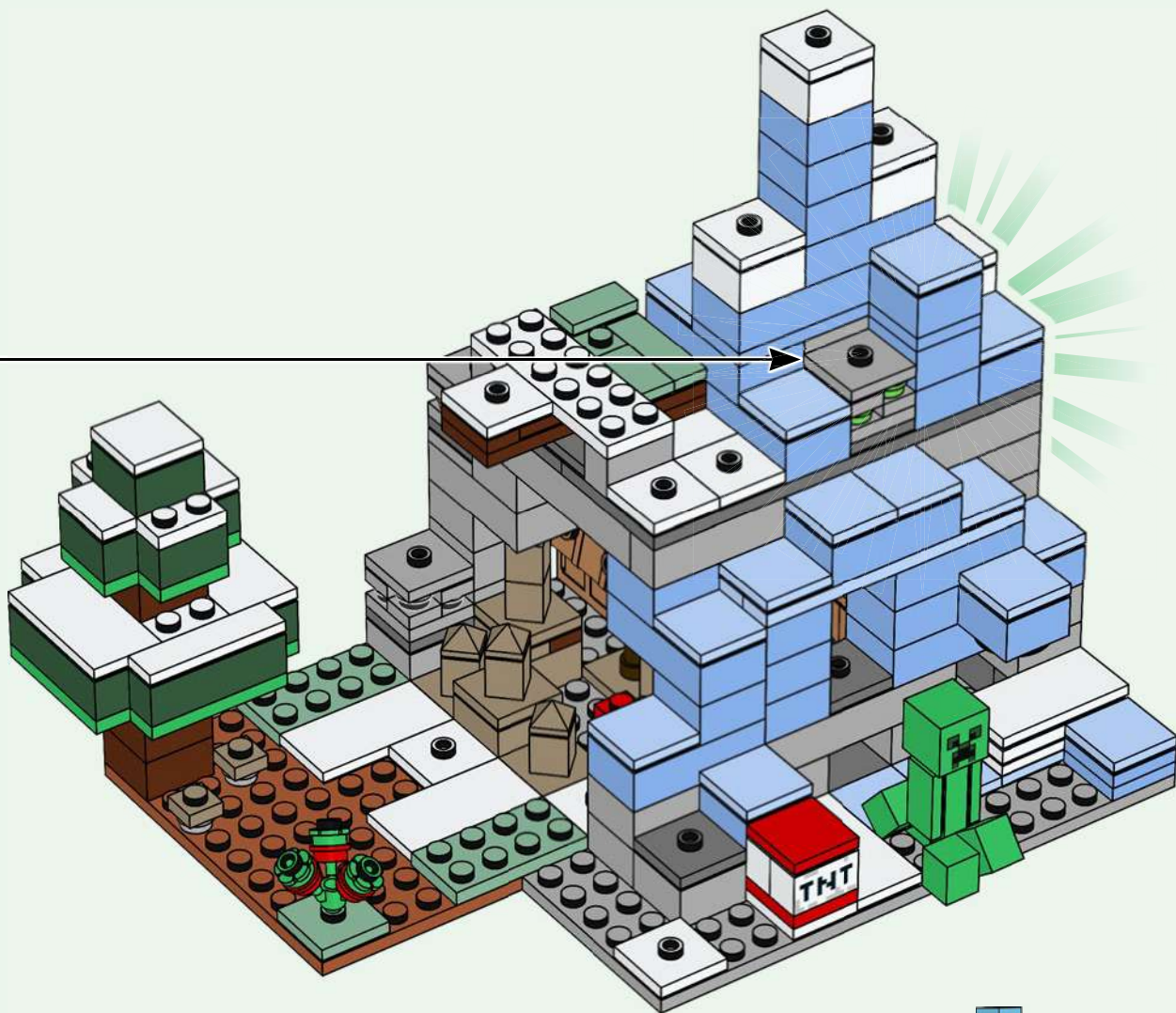



1x

82



2x

83



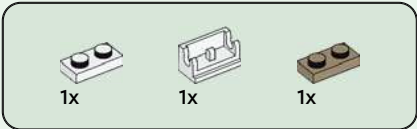

84

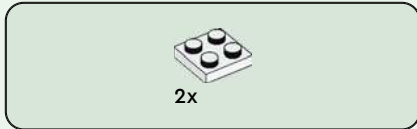
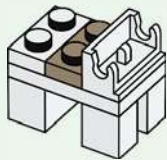

85

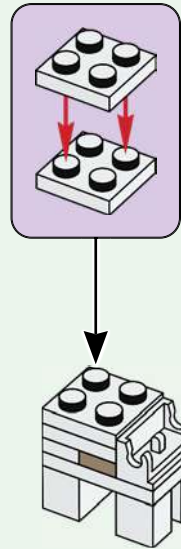

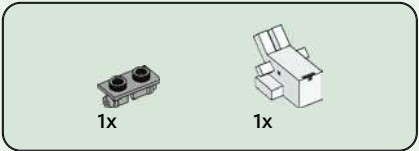

86

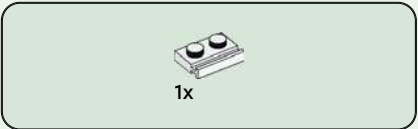
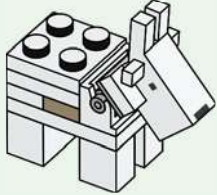
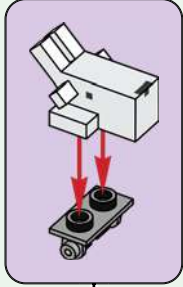

87

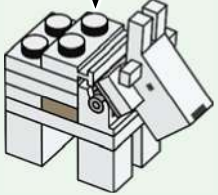
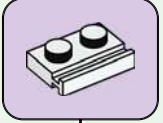

88

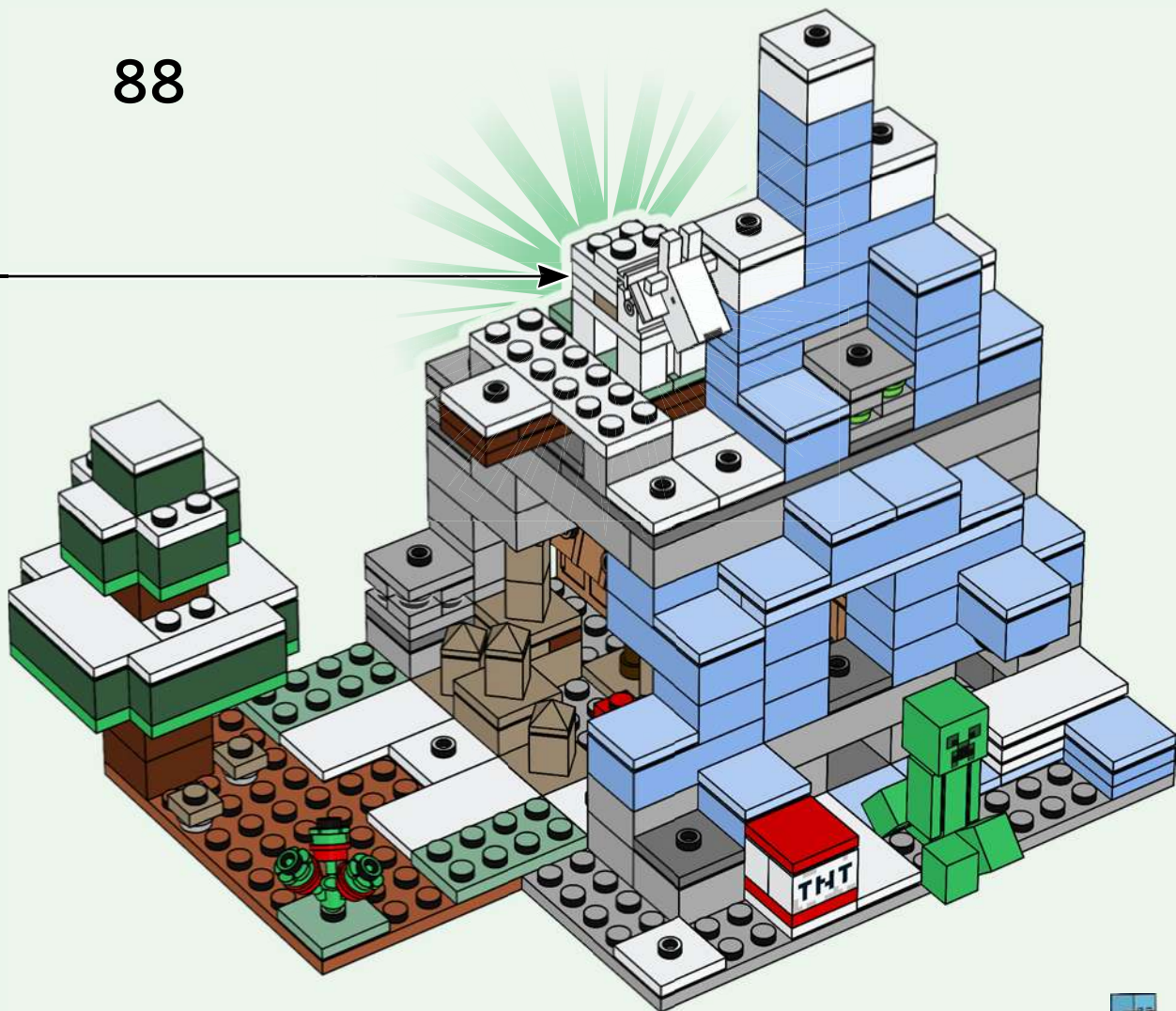



89

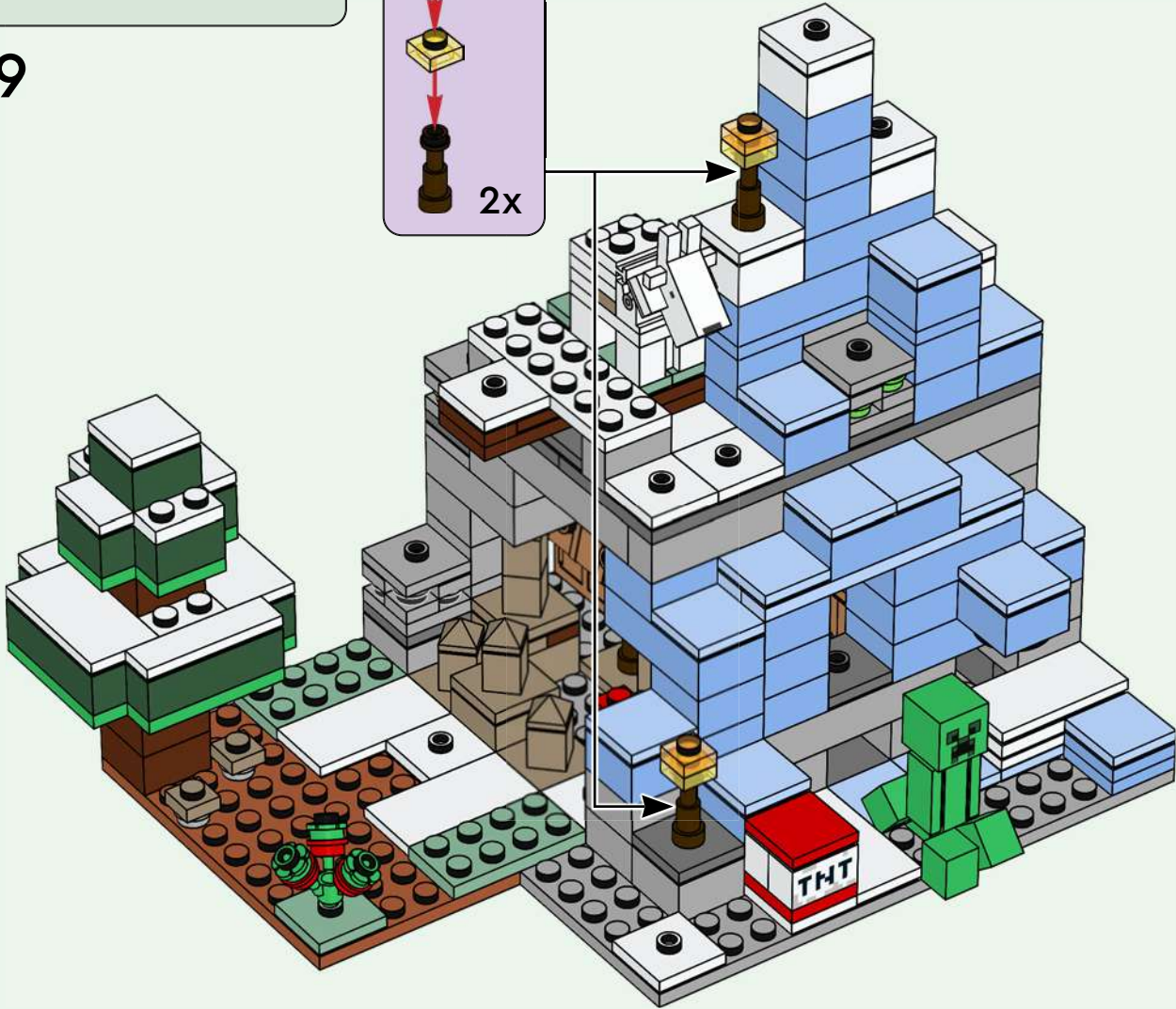
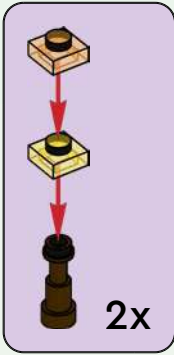





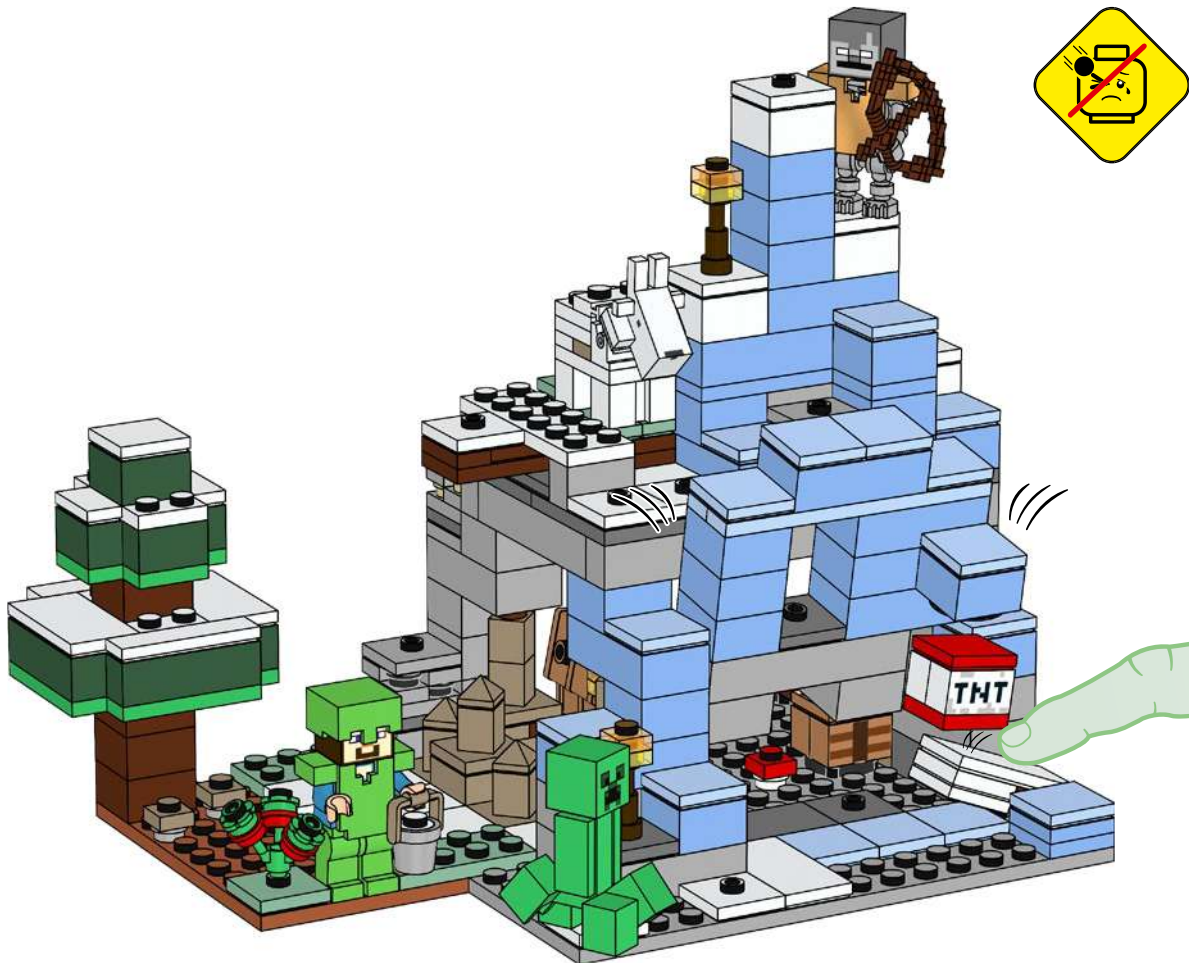

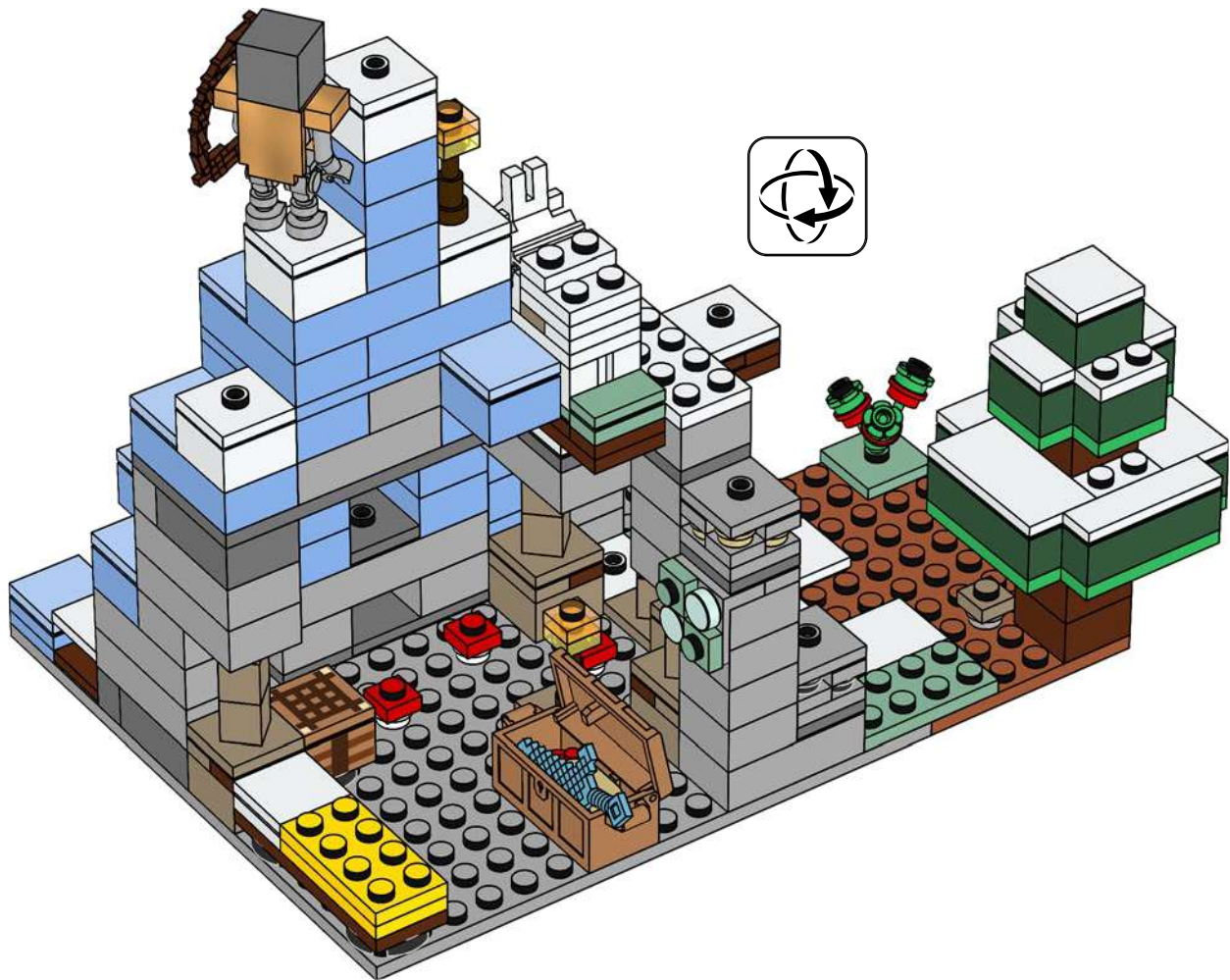



# MINECRAFT

21243



21244



21241



21245





# MINECRAFT

21242



21246

2x  
6322818



1x  
6104050



2x  
6097024



1x  
6097003



1x  
6394960



1x  
6102984



17x  
6162894



2x  
6372125



1x  
6093623



1x  
6426170



1x  
4210762



6x  
6126083



2x  
4211105



2x  
4560184



1x  
4539429

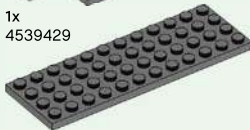

1x  
4210706

4x  
614126



3x  
403226



2x  
6099189



2x  
4616578



1x  
6282619



1x  
6186826



1x  
6202626



2x  
6249817



11x  
4201235



3x  
4653540



14x  
4205058



1x  
6101858



1x  
6263971



1x  
6338355



1x  
6400307



1x  
6162384



3x  
4538950



2x  
4245570



1x  
6214611



2x  
4245571



3x  
4260493

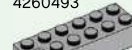

1x  
4211795



1x  
4211522

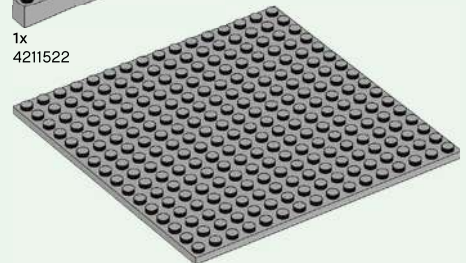

1x  
4620130



3x  
6252045



3x  
6405699



9x  
6001824



2x  
4549436



1x  
6245275



1x  
4528604



7x  
6126075



4x  
4255416



3x  
4550168



1x  
6093629



 [LEGO.com/service](https://www.LEGO.com/service)

4x  
614101

1x  
302301

2x  
4264360

1x  
393701

2x  
306901

2x  
6097028

1x  
6397842

1x  
4249563

3x  
302201

11x  
6126046

2x  
306801

4x  
300301

1x  
242001

1x  
6013866

1x  
302101

2x  
243101

7x  
4560178

2x  
302001

1x  
379501

4x  
4161734

2x  
6397819

3x  
6223427

1x  
6100565

3x  
302421

1x  
302221

1x  
306821

1x  
6331822

2x  
302024

4x  
6109808

3x  
6135287

1x  
6368255

1x  
6162485

1x  
6269971

2x  
302328

2x  
306928

1x  
6336574

1x  
6424003

1x  
6192875

2x  
371028

1x  
302028

1x  
4116671

3x  
6252040

3x  
4216581

3x  
4221744

4x  
4211150

1x  
4211151

1x  
6192310

1x  
6089103

4x  
4211210

2x  
6257604

2x  
4211186

1x  
4211247

2x  
6423983

2x  
4211525

2x  
6252203

1x  
6057487

12x  
4211399

1x  
4211470

1x  
4211398

2x  
4211388

1x  
6117967

1x  
6435715

3x  
4211397

3x  
6126082

9x  
4211387

1x  
4211349

10x  
4211385

1x  
4211393

YOU COULD **WIN**



Scan this QR code or go to **LEGO.COM/PRODUCTFEEDBACK** and give us your short feedback about this LEGO® set for a chance to win a cool LEGO prize.

Terms and Conditions apply\*

**DE: Du könntest GEWINNEN.** Es gelten die Teilnahmebedingungen\* **FR: Tu pourrais GAGNER.** Des conditions s'appliquent\* **IT: Potresti VINCERE tu.** Termini e condizioni sono applicabili\* **ES: Puedes GANAR.** Aplican términos y condiciones\* **PT: Poderá GANHAR.** Aplicam-se termos e condições\* **JA: プレゼント付き! 利用規約が適用されます\*** **ZH: 轻松获奖. 条款和条件适用\*** **KO: 상품의 주인이 되어보세요. 소정의 약관이 적용됩니다\*** **RU: Вы можете ВЫИГРАТЬ.** Действуют положения и условия\* **PL: Szansa na WYGRANĄ.** Obowiązują warunki korzystania\* **CS: Máte šanci VYHRÁT.** Platí všeobecné smluvní podmínky\* **SK: Máte šancu VYHRAŤ.** Platia všeobecné zmluvné podmienky\* **HU: TE IS NYERHETSZ.** Felhasználási feltételek érvényesek\* **RO: Ai putea CÂȘTIGA.** Se aplică termeni și condiții\* **BG: Можете да СПЕЧЕЛИТЕ.** Има определени правила и условия\* **LV: Tu vari LAIMĒT.** Ir spēkā noteikumi un nosacījumi.\* **ET: Sul on võimalus VÕITA.** Kehtivad tingimused\* **LT: Jūs galite LAIMĖTI.** Taikomos sąlygos\*  
\*LEGO.com/productfeedback-terms

LEGO and the LEGO logo are trademarks of the LEGO Group. ©2023 The LEGO Group.



© 2023 Mojang AB. All Rights Reserved. Minecraft, the Minecraft logo, the Mojang Studios logo and the Creeper logo are trademarks of the Microsoft group of companies.

6448773