



Friends™

41752





[LEGO.com/sustainable-packaging](https://LEGO.com/sustainable-packaging)



# BUILDER



Apple and the Apple logo are trademarks of Apple Inc., registered in the U.S. and other countries and regions. App Store is a service mark of Apple Inc.

Google Play and the Google Play logo are trademarks of Google LLC.

Tencent and the Tencent logo are trademarks of Tencent Inc.

[LEGO.com/devicecheck](https://www.lego.com/devicecheck)

**EN** Ask parents' permission before going online | **DE** Eltern um Erlaubnis bitten, bevor du online gehst | **FR** Demande l'autorisation d'un parent avant d'aller en ligne | **IT** Chiedi il permesso ai tuoi genitori prima di andare online | **ES** Pídeles permiso a tus papás antes de conectarte a Internet | **PT** Pede autorização aos pais antes de acederes online | **JA** オンラインになる前に ほか者の方のきよかをもらおう | **ZH** 上网前应先征得父母的同意 | **KO** 온라인 접속 전에 보호자 동의가 필요합니다 | **RU** Спроси разрешения у родителей, прежде чем заходить в интернет | **PL** Poproś rodziców o zgodę, zanim wejdiesz do Internetu | **CS** Než půjdeš na internet, požádej rodiče o svolení | **SK** Skôr než pôjdeš na internet, vypýtaj si povolenie od rodičov | **HU** Kérj szülői engedélyt, mielőtt online csatlakoznál! | **RO** Cere permisiunea părinților înainte de a te conecta online | **BG** Поискайте разрешение от родител, преди да влезете онлайн | **LV** Pirms došanās tiešsaistē palūdz atļauju vecākiem | **ET** Enne Interneti kasutamist küsi vanematelt luba | **LT** Prieš prisijungdami prie interneto, atsklauskite tėvų

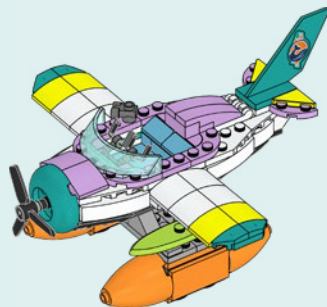
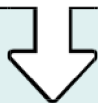
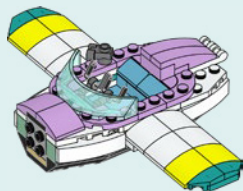
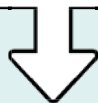





# ZAC

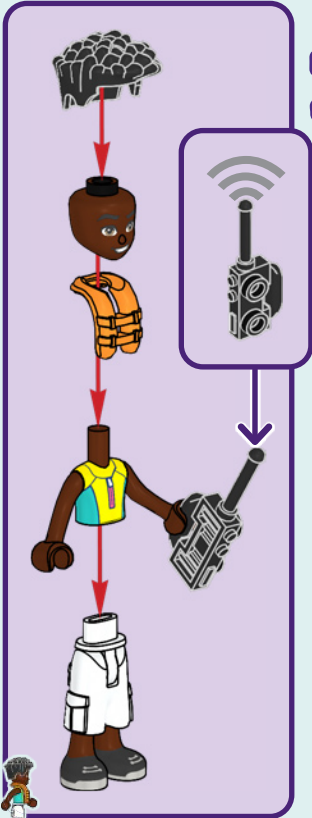

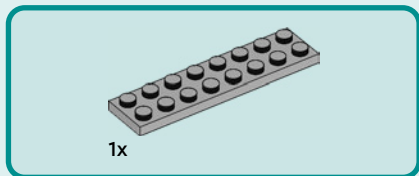

1

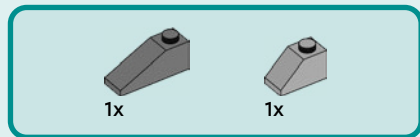
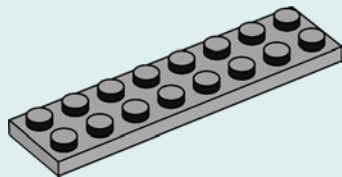

2

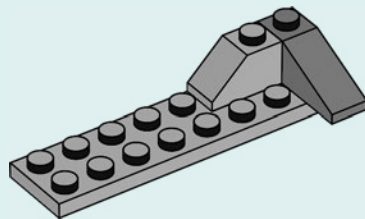



1x



1x

3

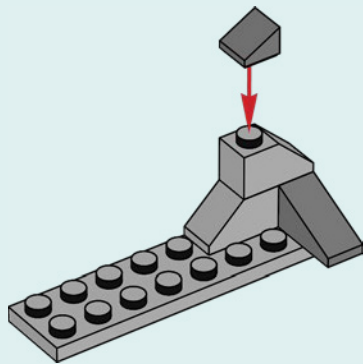

1x

4

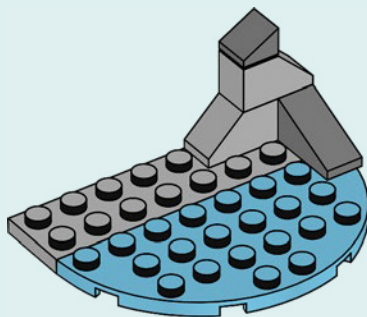

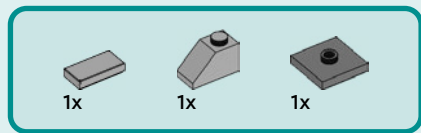

5

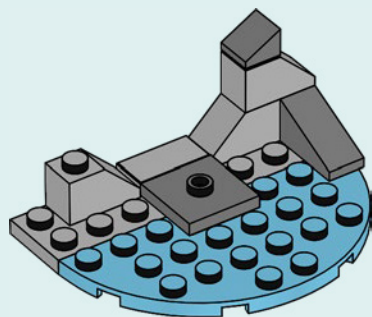

6

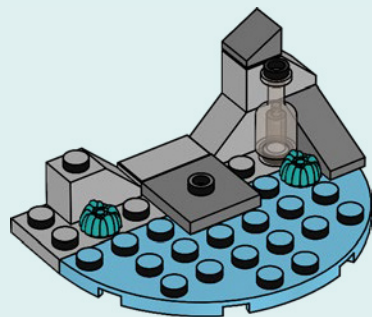



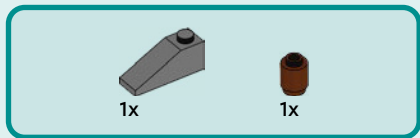

7

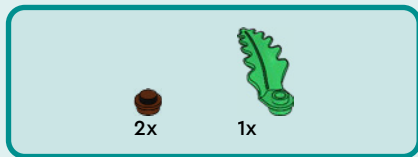
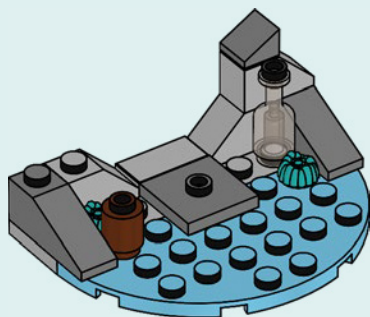

8

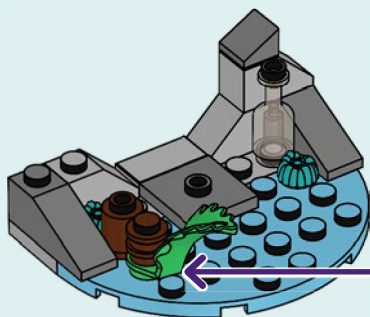
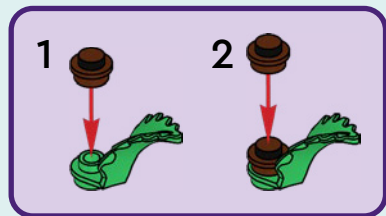

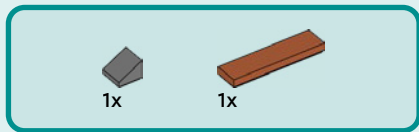

9

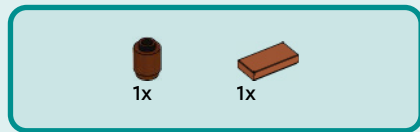
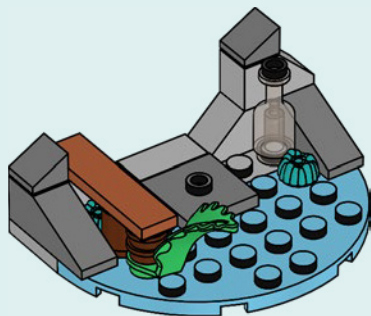

10

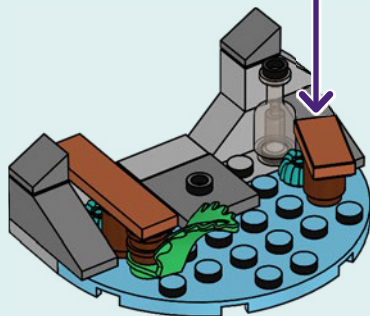



1x



1x

11

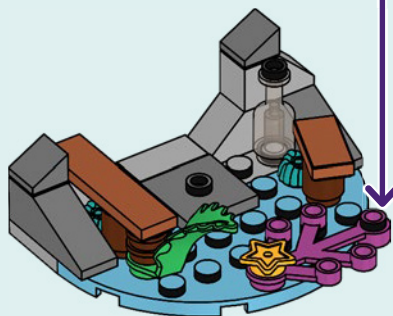
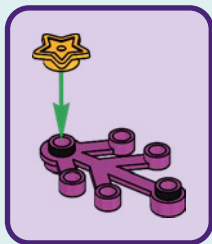

1x

12



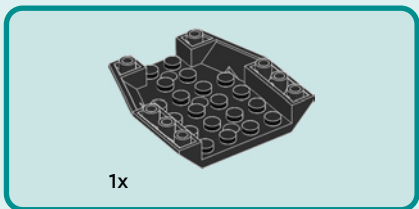
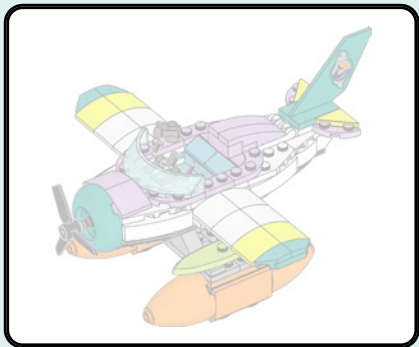

1

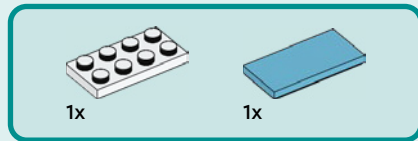
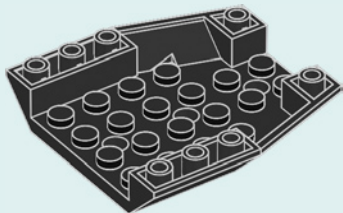

2

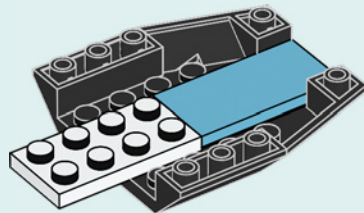



2x



2x

3

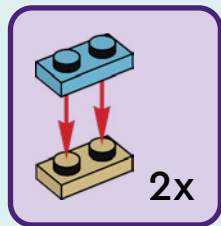

2x

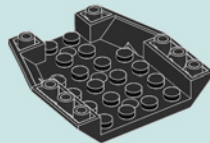
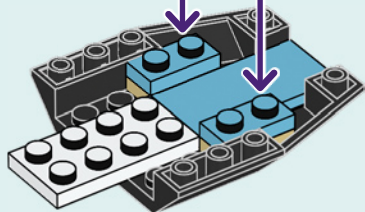

1x

4

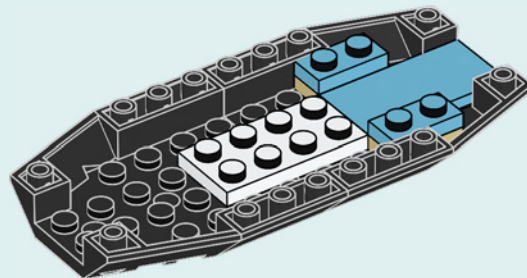



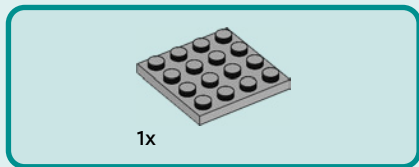

5

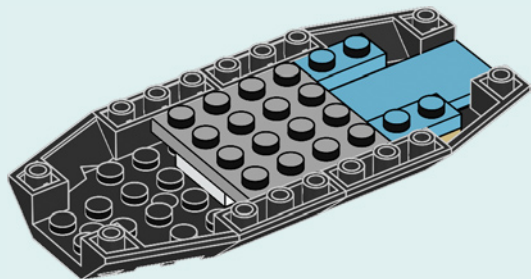

6

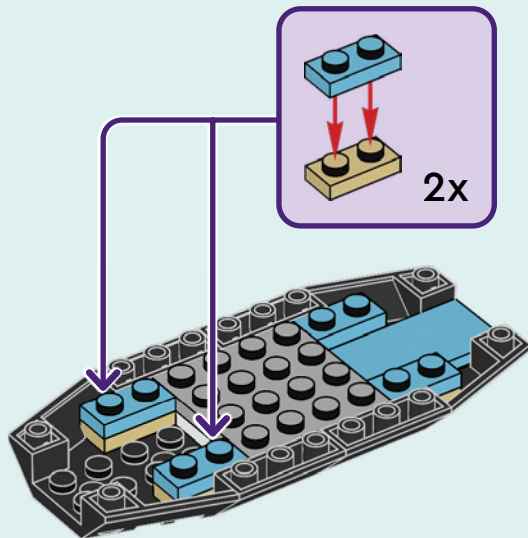

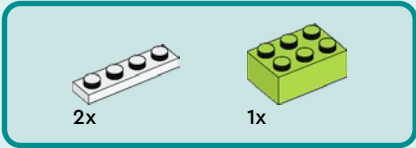

7

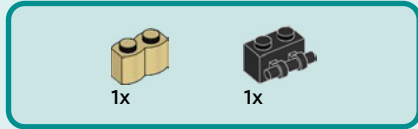
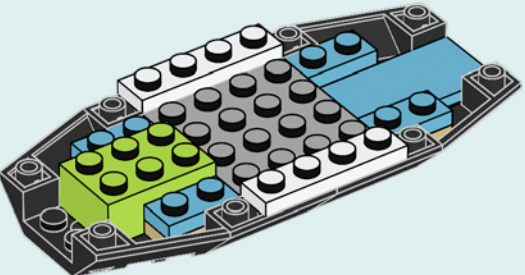

8

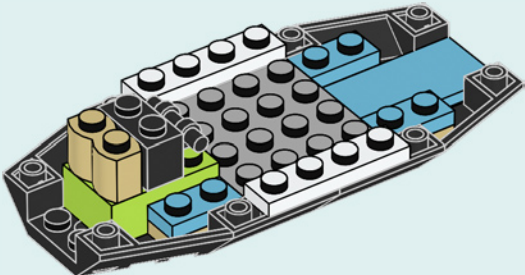

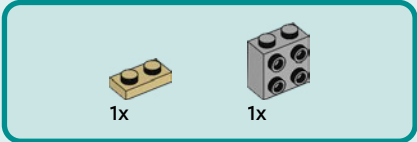

9

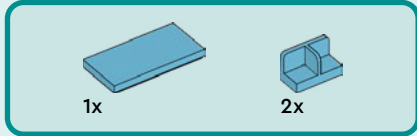
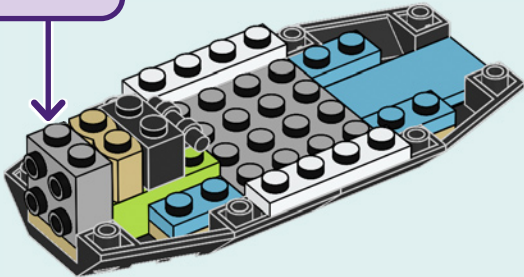
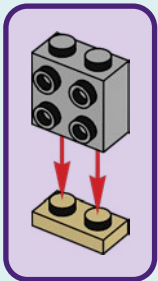

10

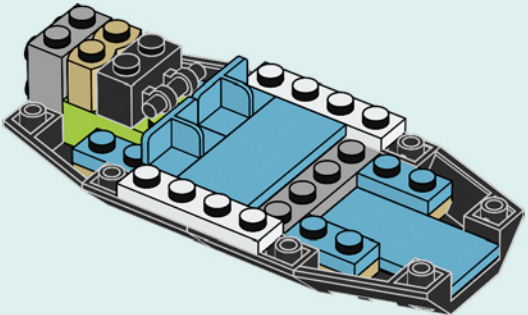



2x



1x

11

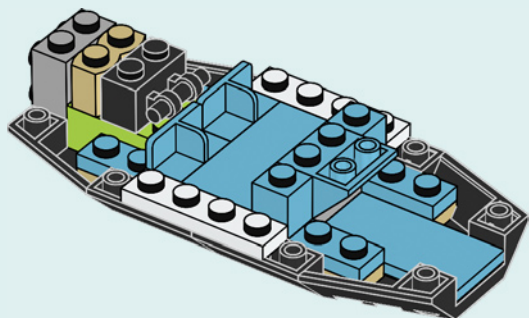

2x

12

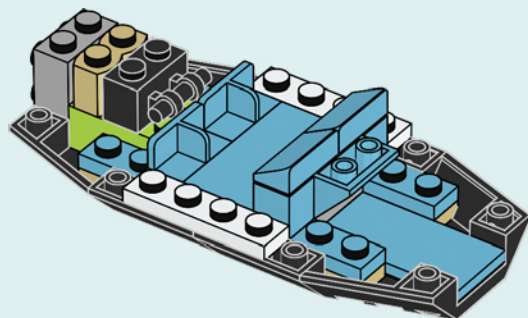

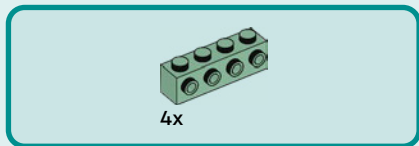

13

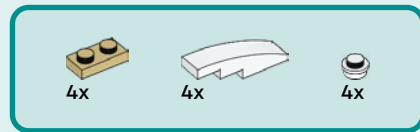
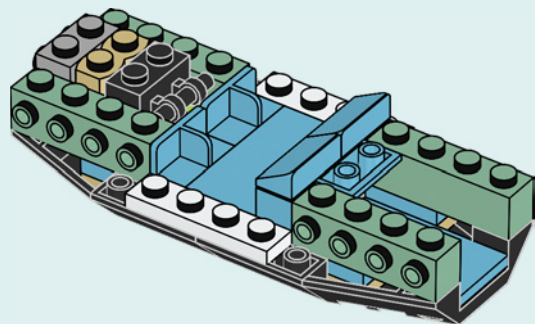

14

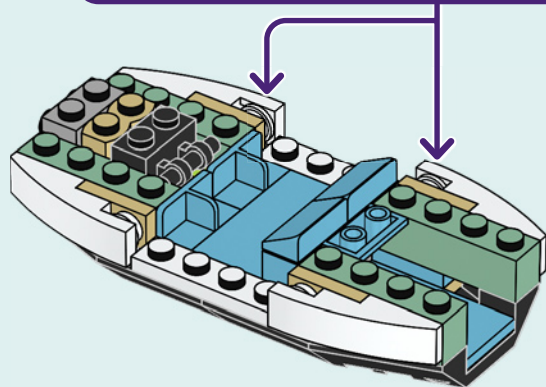
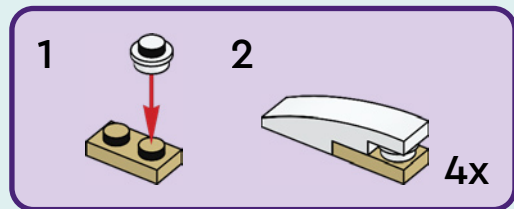



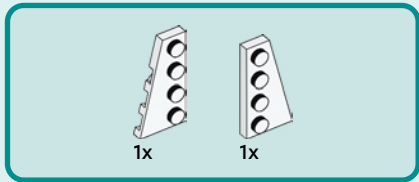

15

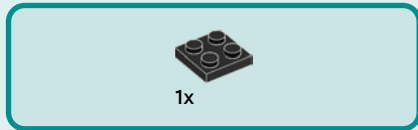
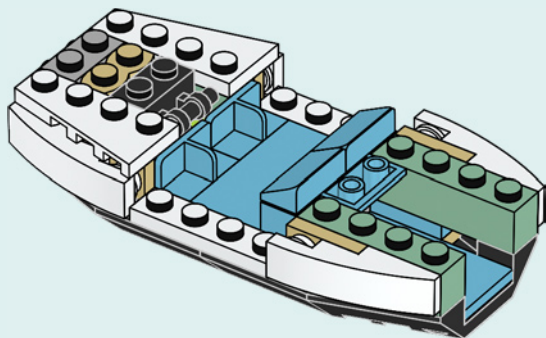

16

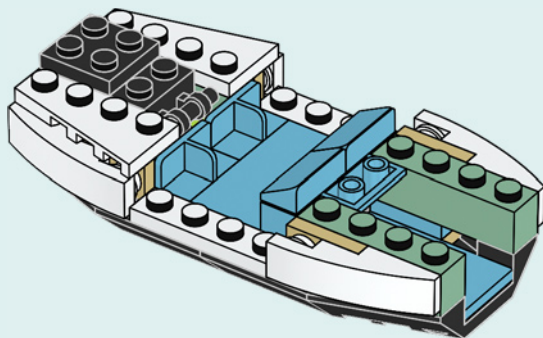



2x

17

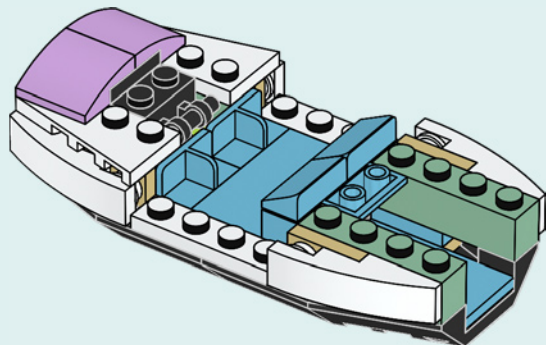

1x

18

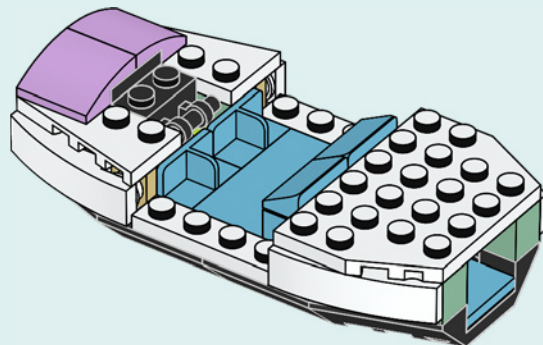

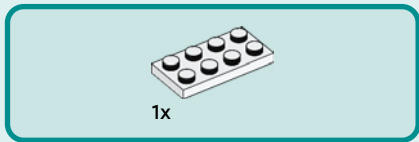
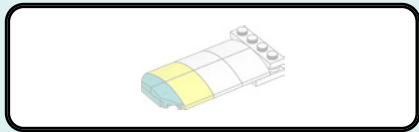

19

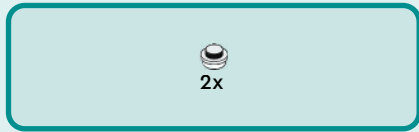
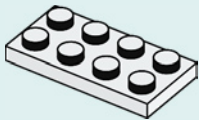

20

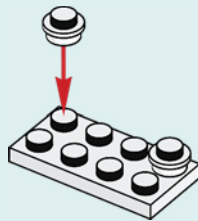

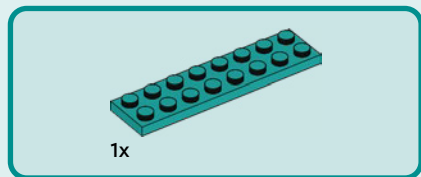

21

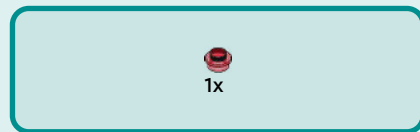
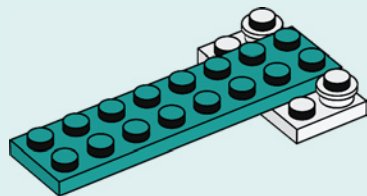

22

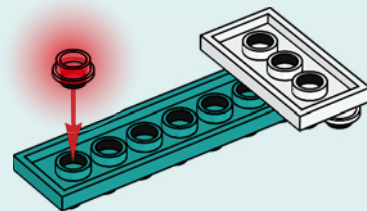



1x

23

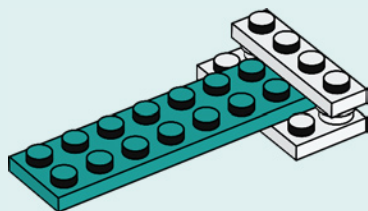

4x



2x

24

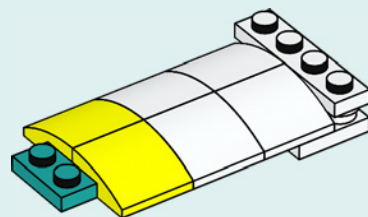





1x



1x

25

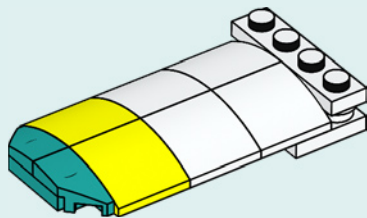

26

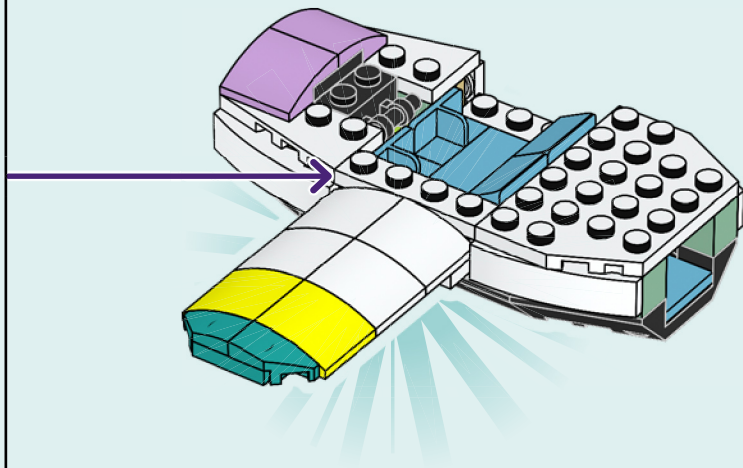

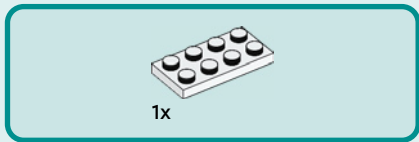
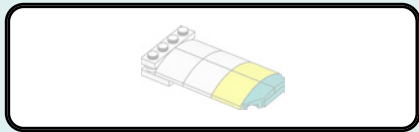

1x

27



2x

28

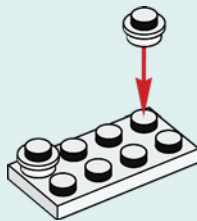

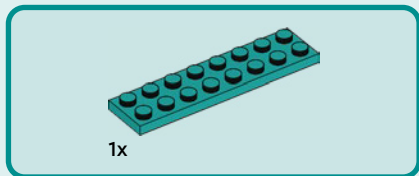

29

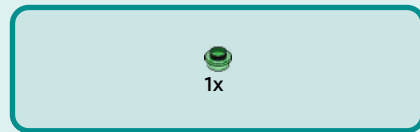
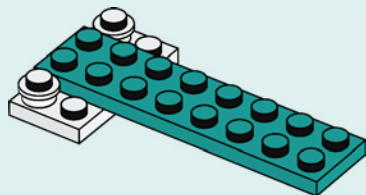

30

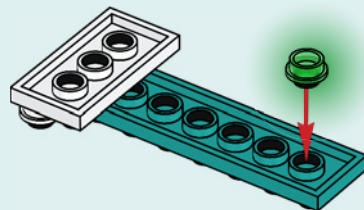



1x

31

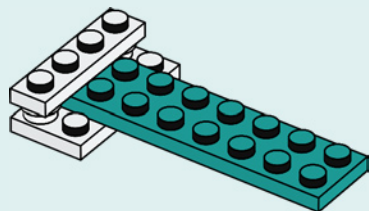

4x



2x

32

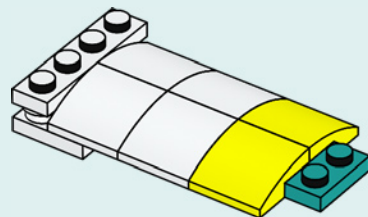



1x



1x

# 33

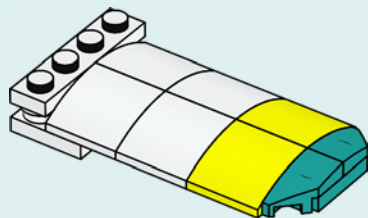

# 34

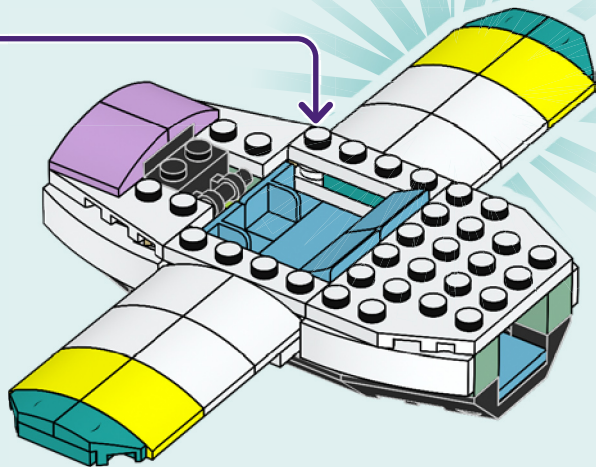



2x

35

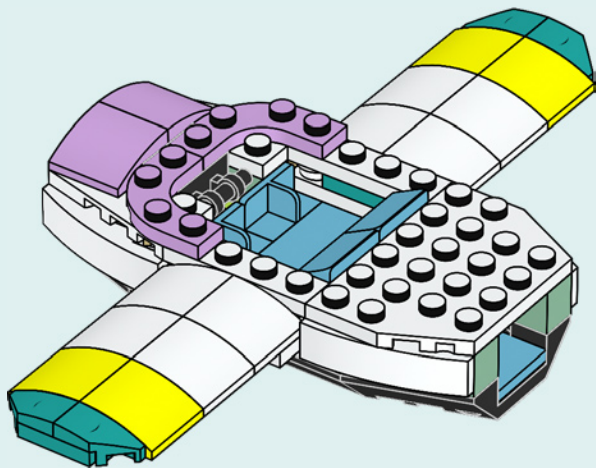

2x



2x

36

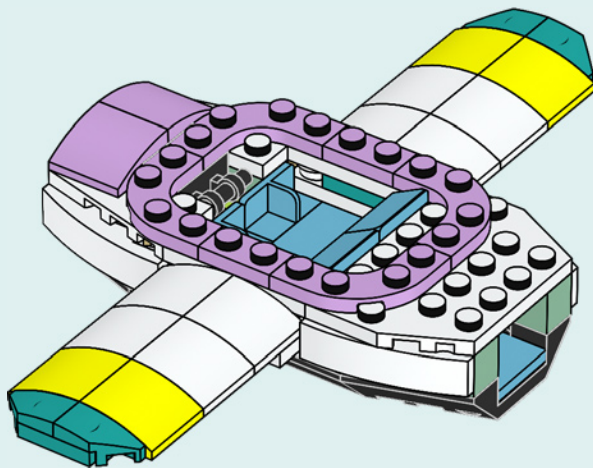



4x

37

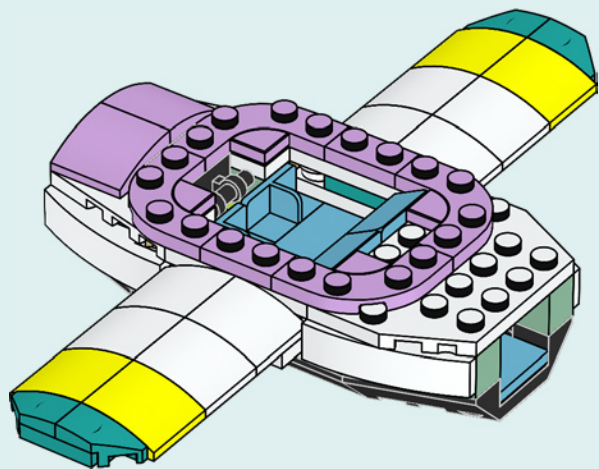

1x



1x

38

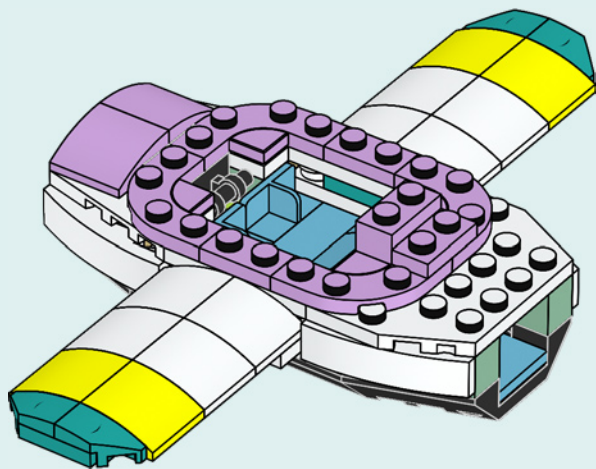



2x

39

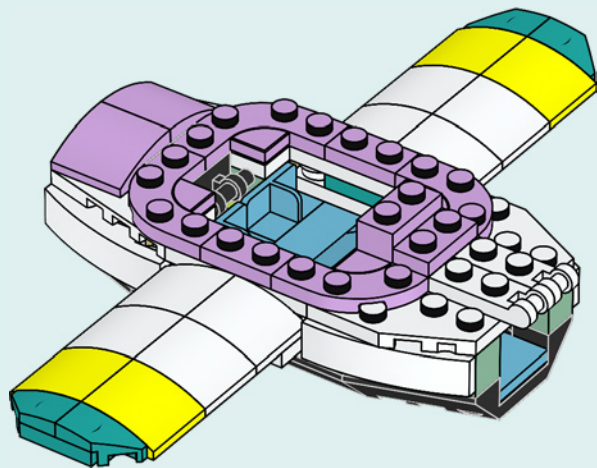

2x

40

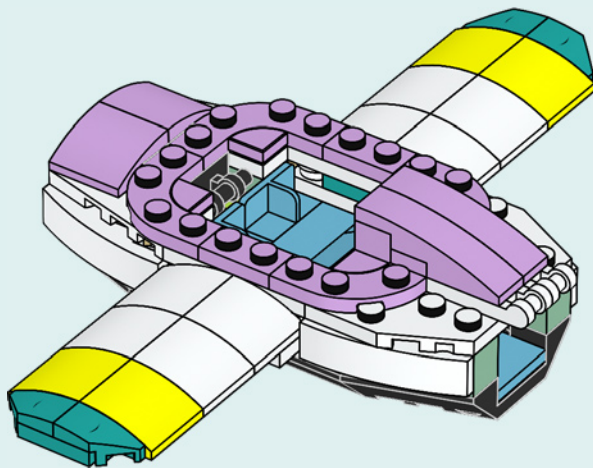





2x



2x

# 41

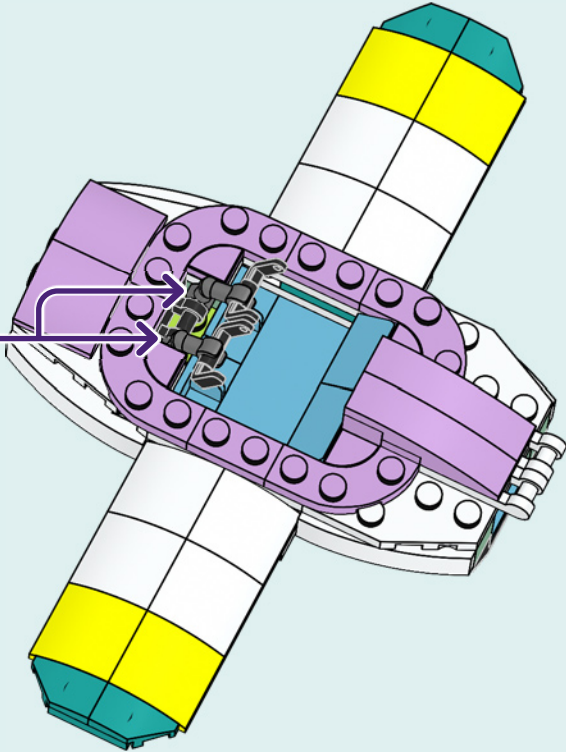
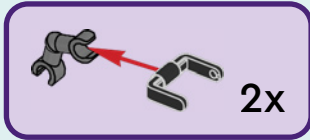

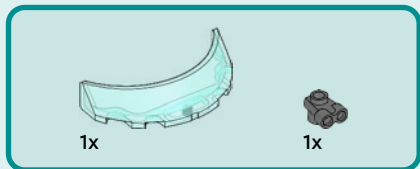

42

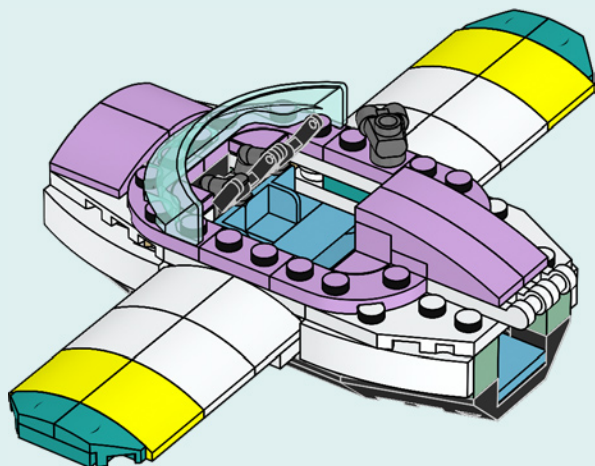

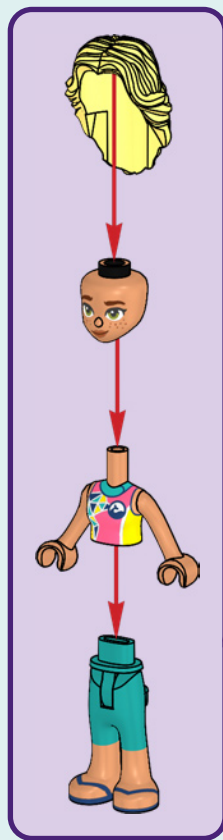

DIA

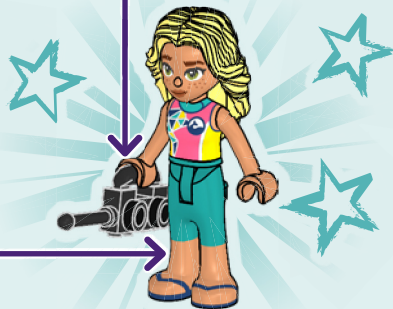

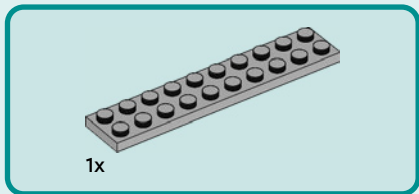
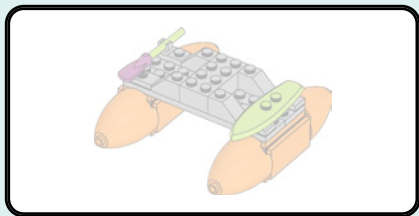

43

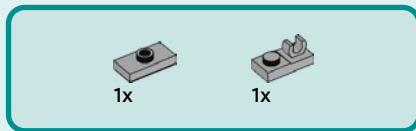
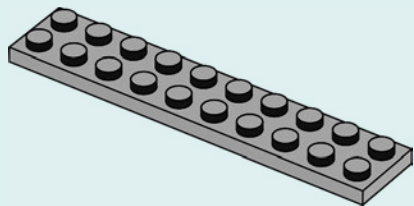

44

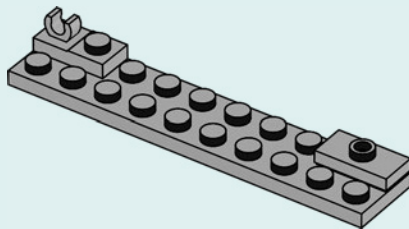



2x

45

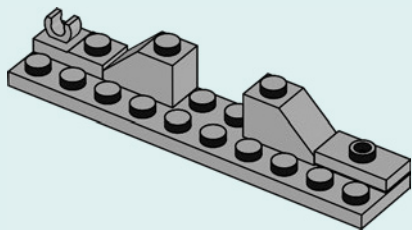

1x

46

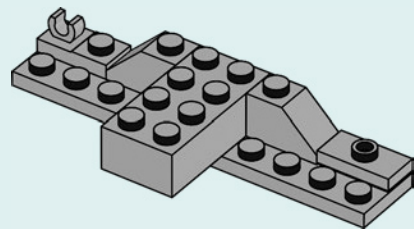





2x



1x



1x

49

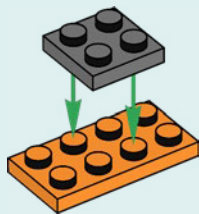

1x



1x

50

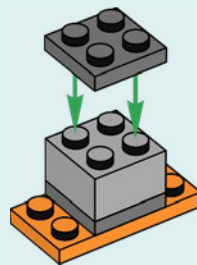



2x

51

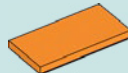
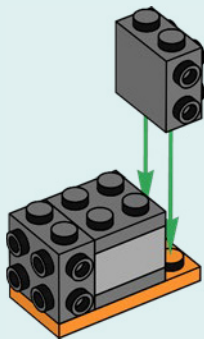

2x

52

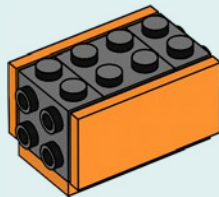





1x

53

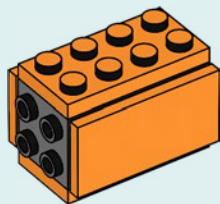

2x

54

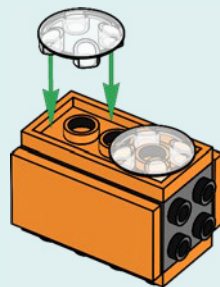

2x

55

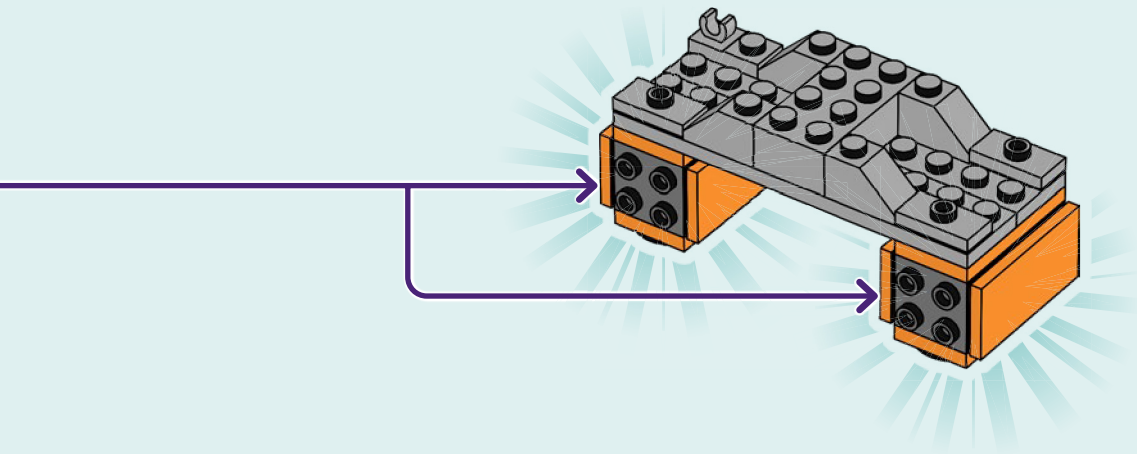



4x

56

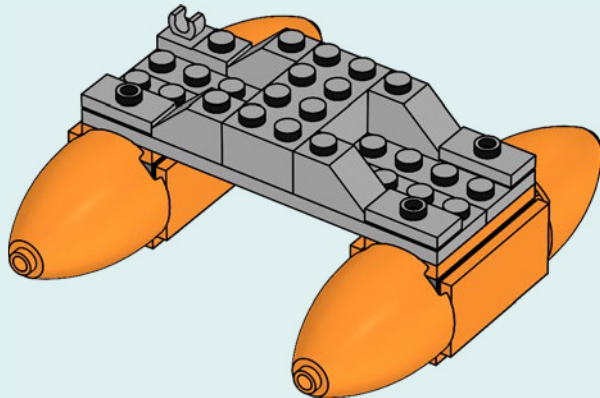

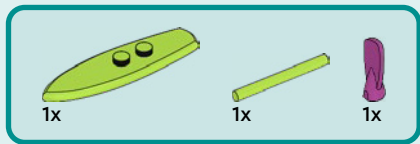

57

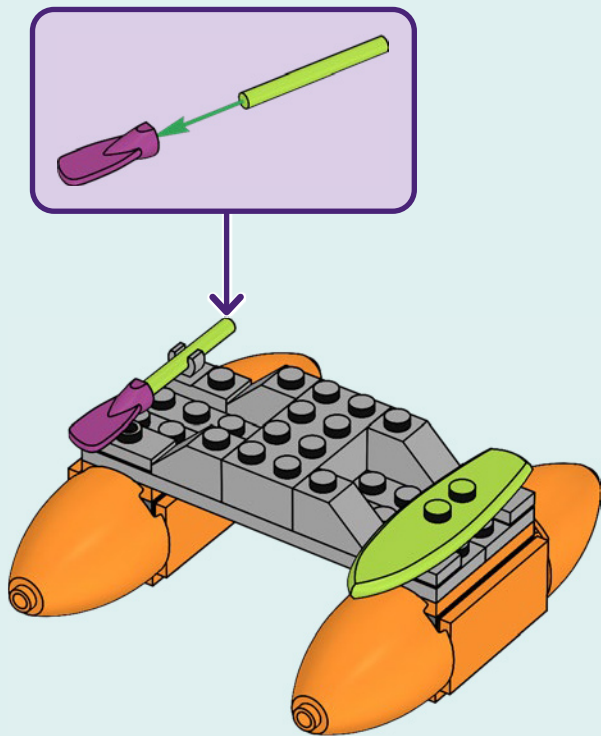

58

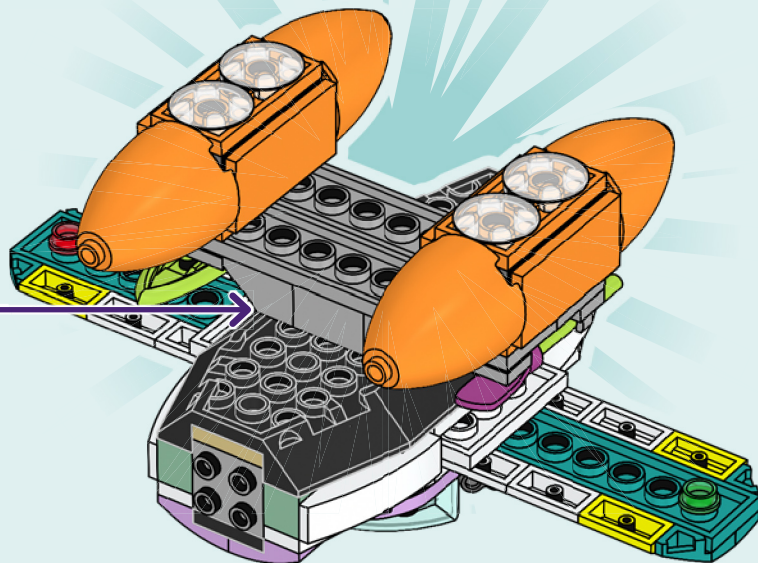

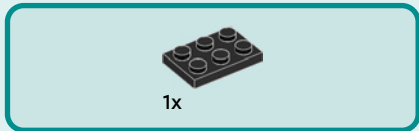
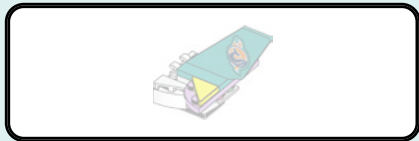

59

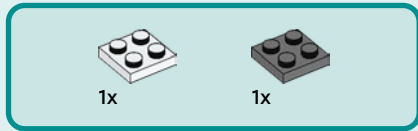
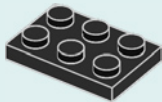

60

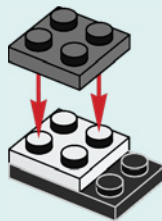



2x

61

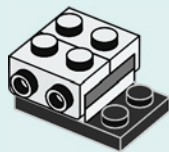

1x

62

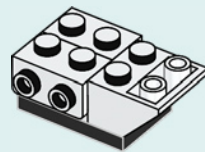



2x



2x

# 63

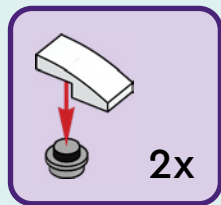

2x

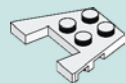
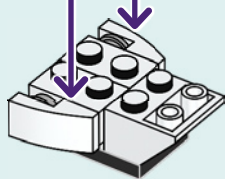

1x

# 64

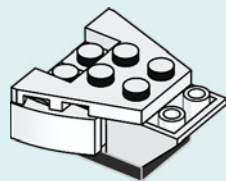





1x



1x

65



1x

66

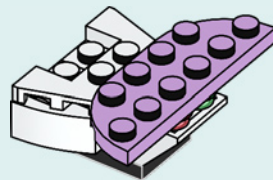



1x

67

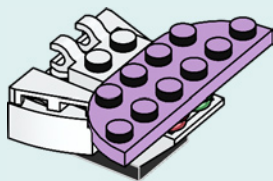

2x

68

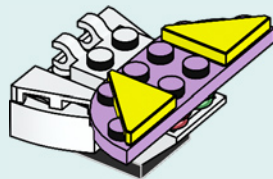

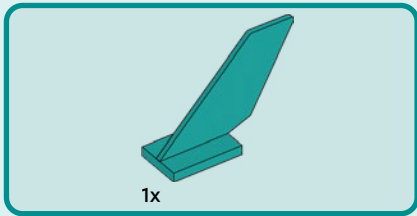

69

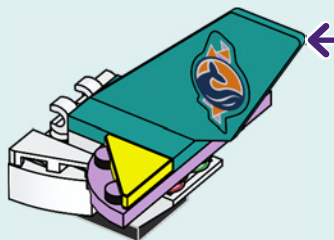
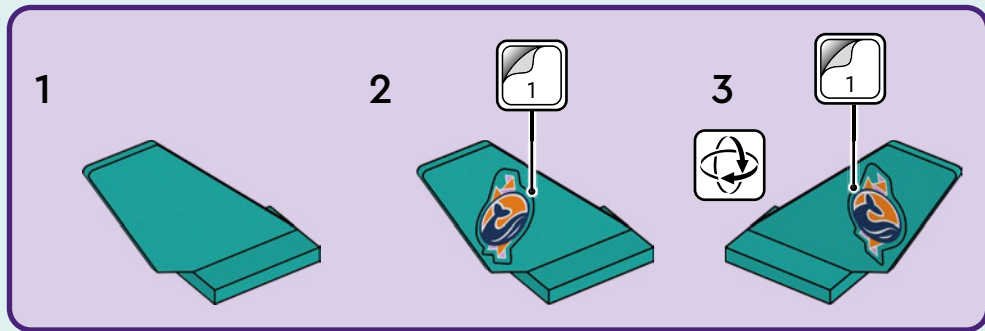

70

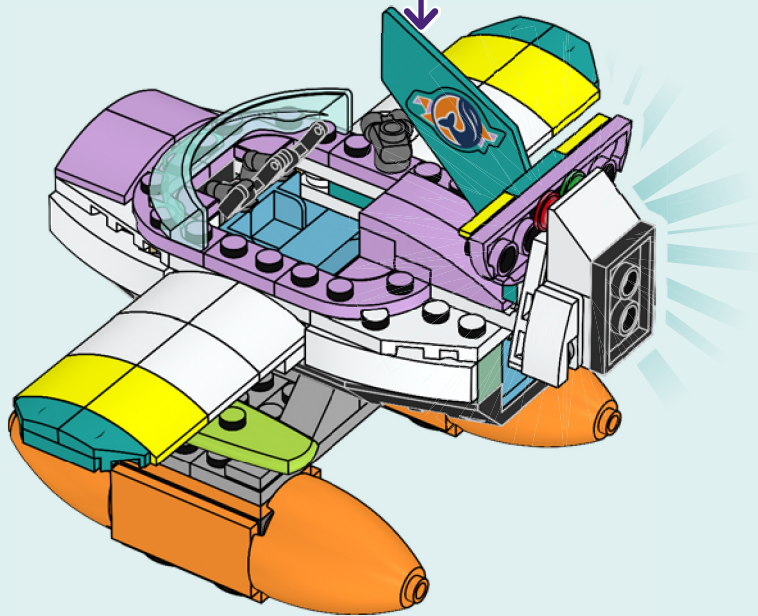
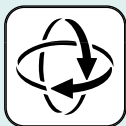



1x



1x

# 71

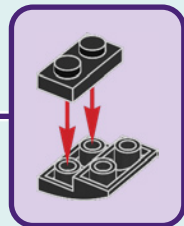
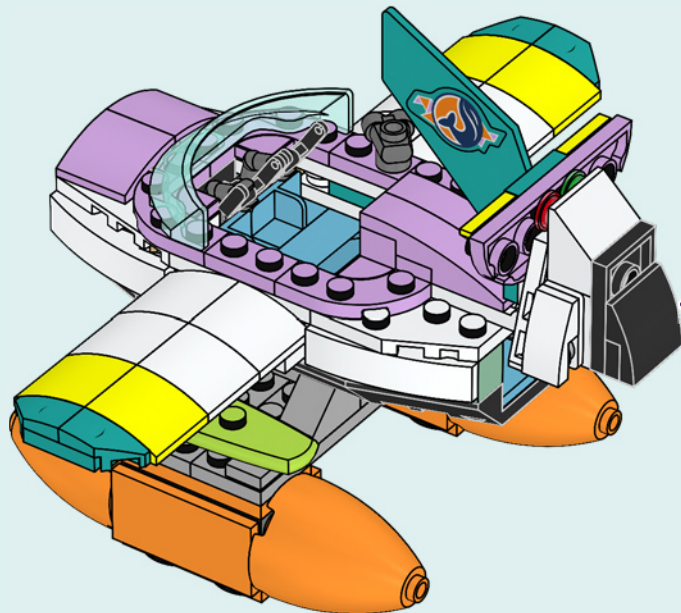



1x



1x



1x

# 72

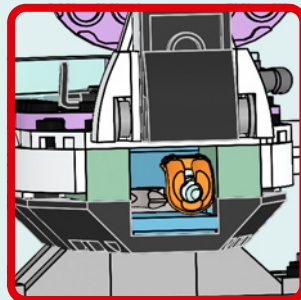
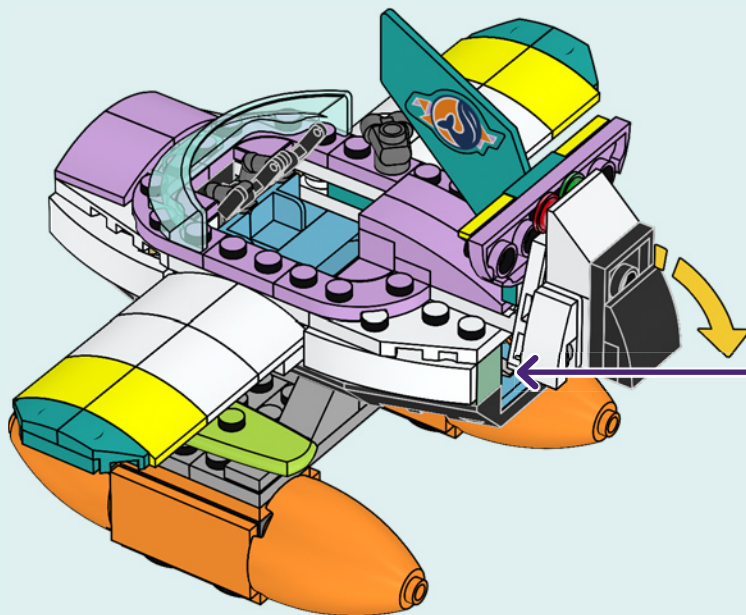

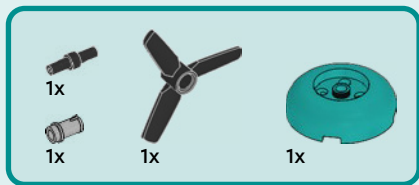

73

1

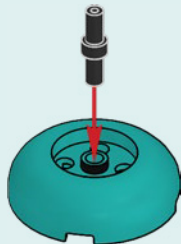

2

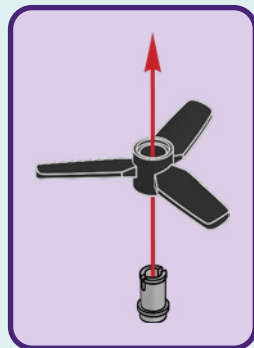
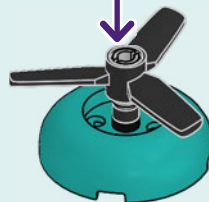

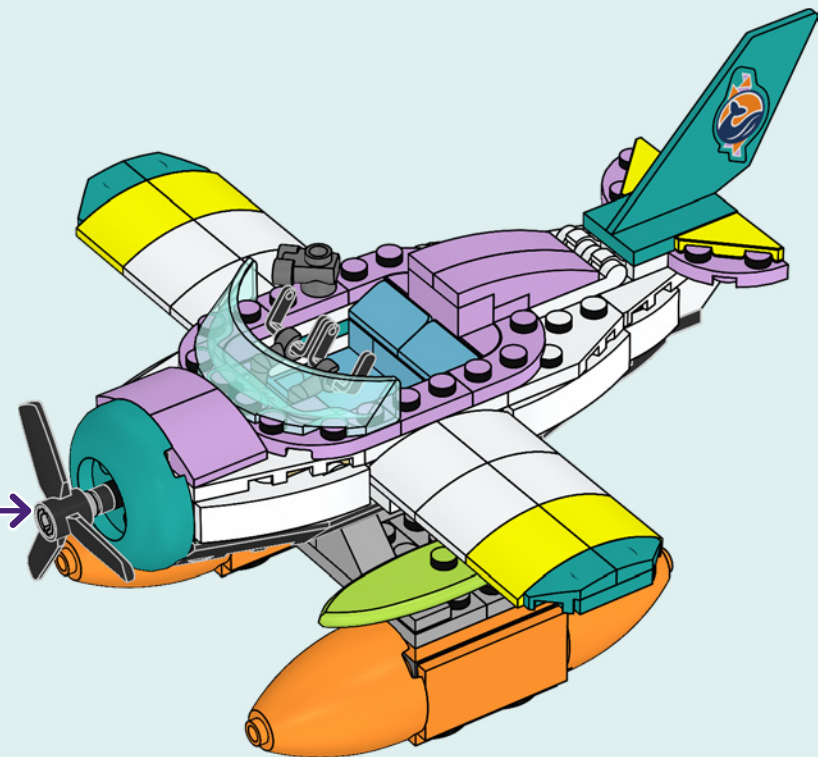







8x  
614101



1x  
6428259



1x  
4160857



1x  
4161326



2x  
6034044



2x  
6018774



1x  
6347287



8x  
6047220



1x  
6366391

**58**



1x  
302201



2x  
4515364



4x  
371001



4x  
6045936



1x  
6170524



3x  
302001



1x  
4508408



1x  
6435010



1x  
4218749



9x  
4113917



1x  
6435007



1x  
6443990



2x  
6170545



2x  
6245281



1x  
6371584



1x  
6409770



1x  
302326



1x  
4288212



1x  
302226



1x  
6211476



1x  
302126



1x  
6360206



2x  
6195436



4x  
6163901



2x  
6208450



1x  
6246853



2x  
6136310



4x  
6441084



4x  
4158355



4x  
4648853



2x  
6240221



2x  
6434882



2x  
6291018



1x  
6452337



2x  
6291017



1x  
6442917



1x  
6442912



2x  
6257063



1x  
6420220



1x  
6268822



1x  
6327442



1x  
4220631



1x  
6102906



4x  
6423405



1x  
4614158



1x  
6074893

2x  
4211525

1x  
4211483

7x  
4211614

1x  
4211414

3x  
6066097

1x  
6326078

1x  
6123809

2x  
4211387

1x  
6247372

1x  
6411022

1x  
4211385

1x  
4243797

1x  
4211406

2x  
4211462

1x  
6167776

2x  
4504378

1x  
6263570

2x  
6318697

4x  
6314192

1x  
6126083

5x  
4211094

2x  
4211045

1x  
6167576

2x  
4619652

2x  
6097444

2x  
6133911

4x  
6097419

1x  
6070756

2x  
6097042

1x  
6138571

4x  
6240465

3x  
6099190

1x  
6099352

2x  
6112964

2x  
6045945

4x  
6381957

1x  
6204060

2x  
4211183

2x  
4216581

1x  
6416487

1x  
6445170

1x  
6412881

2x  
6425975

4x  
6380125

1x  
6444779

 [LEGO.com/service](https://www.LEGO.com/service)



YOU COULD  
**WIN**



Scan this QR code or go to  
**LEGO.COM/PRODUCTFEEDBACK** and give  
us your short feedback about this LEGO® set  
for a chance to win a cool LEGO prize.

Terms and Conditions apply\*

**EN: YOU COULD WIN.** Terms and Conditions apply\* **DE: Du könntest GEWINNEN.** Es gelten die Teilnahmebedingungen\* **FR: Tu pourrais GAGNER.** Des conditions s'appliquent\* **IT: Potresti VINCERE tu.** Termini e condizioni sono applicabili\* **ES: Puedes GANAR.** Aplican términos y condiciones\* **PT: Poderá GANHAR.** Aplicam-se termos e condições\* **ZH: 轻松获奖. 条款和条件适用\*** **PL: Szansa na WYGRANĄ.** Obowiązują warunki korzystania\* **CS: Máte šanci VYHRÁT.** Platí všeobecné smluvní podmínky\* **SK: Máte šancu VYHRAŤ.** Platia všeobecné zmluvné podmienky\* **HU: TE IS NYERHETSZ.** Felhasználási feltételek érvényesek\* **RO: Ai putea CÂȘTIGA.** Se aplică termenii și condiții\* **BG: Можете да СПЕЧЕЛИТЕ.** Има определени правила и условия\* **LV: Tu vari LAIMĒT.** Ir spēkā noteikumi un nosacījumi.\* **ET: Sul on võimalus VÕITA.** Kehtivad tingimused\* **LT: Jūs galite LAIMĖTI.** Taikomos sąlygos\*

\*[LEGO.com/productfeedback-terms](https://www.lego.com/productfeedback-terms)