



Disney

43218





LEGO.com/sustainable-packaging

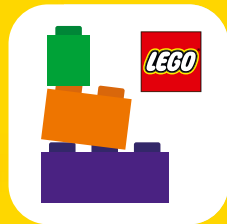

BUILDER



Apple and the Apple logo are trademarks of Apple Inc., registered in the U.S. and other countries and regions. App Store is a service mark of Apple Inc. Google Play and the Google Play logo are trademarks of Google LLC. Tencent and the Tencent logo are trademarks of Tencent Inc.

Q [LEGO.com/devicecheck](https://www.lego.com/devicecheck)

EN Ask parents' permission before going online | DE Eltern um Erlaubnis bitten, bevor du online gehst | FR Demande l'autorisation d'un parent avant d'aller en ligne | IT Chiedi il permesso ai tuoi genitori prima di andare online | ES Pídeles permiso a tus papás antes de conectarte a Internet | PT Peça autorização aos pais antes de acederes online | ZH 上网前应先征得父母的同意 | PL Poproś rodziców o zgodę, zanim wejdiesz do Internetu | CS Než půjdeš na internet, požádej rodiče o svolení | SK Skôr než půjdeš na internet, vypýtaj si povolenie od rodičov | HU Kérj szülői engedélyt, mielőtt online csatlakoznál! | RO Cere permisiunea părinților înainte de a te conecta online | BG Поискайте разрешение от родител, преди да влезете онлайн | LV Pirms došanās tiešsaistē palūdz atļauju vecākiem | ET Enne Interneti kasutamist küsi vanematelt luba | LT Prieš prisijungdami prie interneto, atsilaukite tėvų

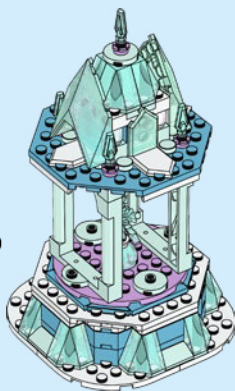
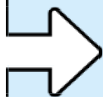
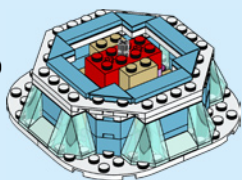
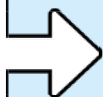

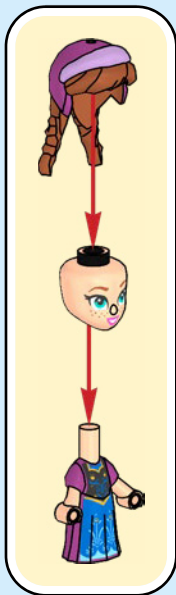



1x

1





2x

2

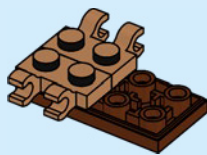

2x

3

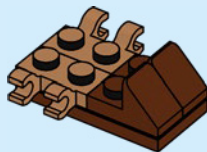



1x



1x

4

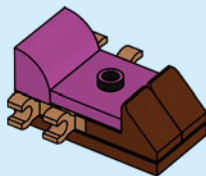

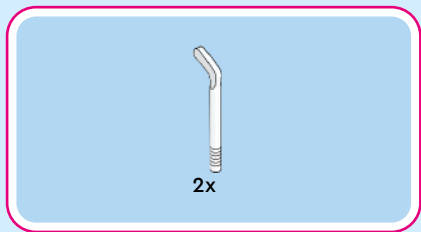

5

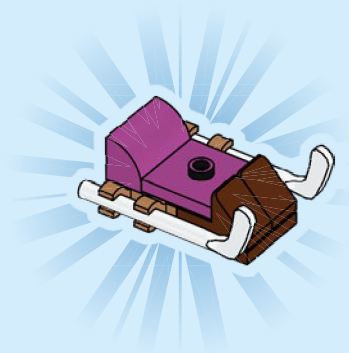



1x

1

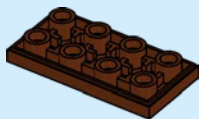



2x

2

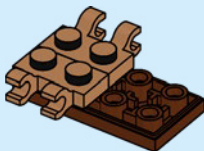

2x

3

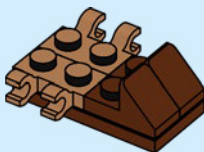



1x



1x

4

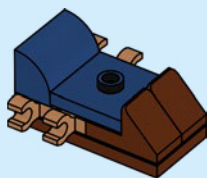

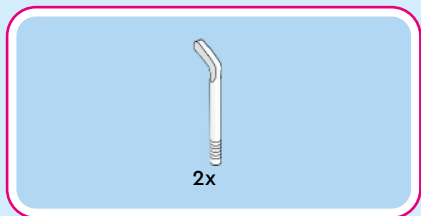

5



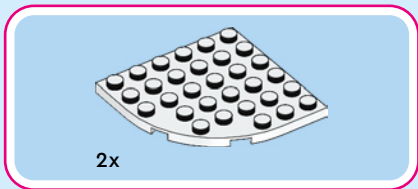

1

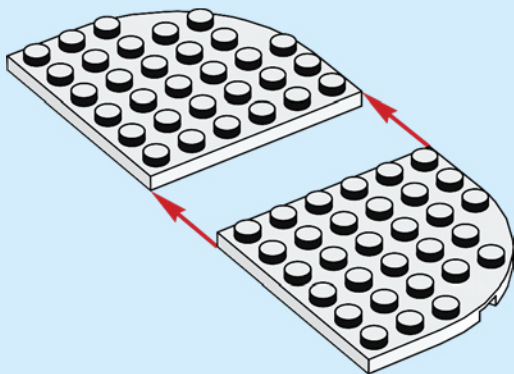



1x

2

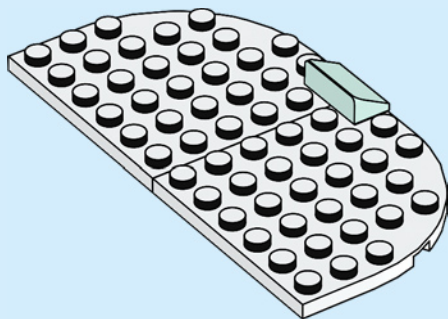



1x



1x

3

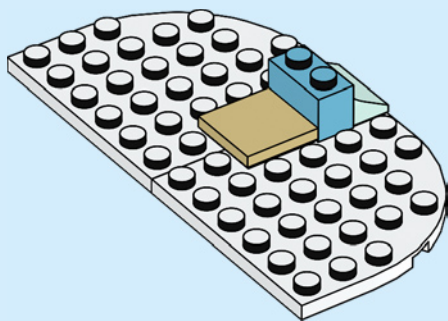

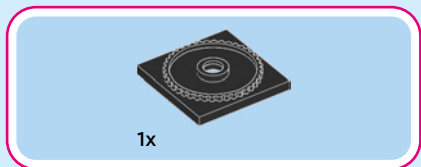

4

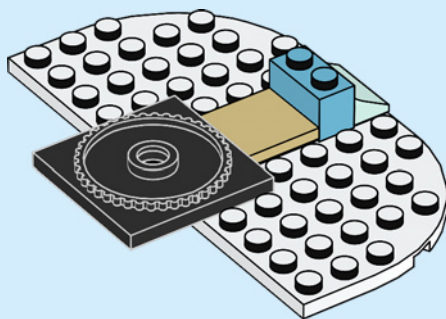



2x

5

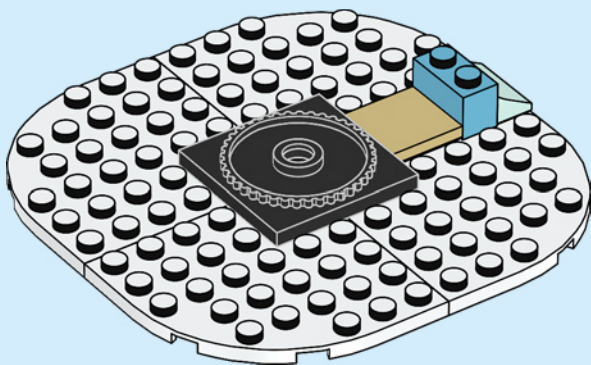



3x

6

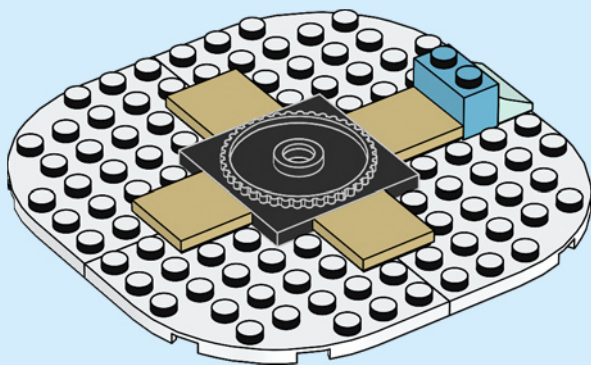



4x

7

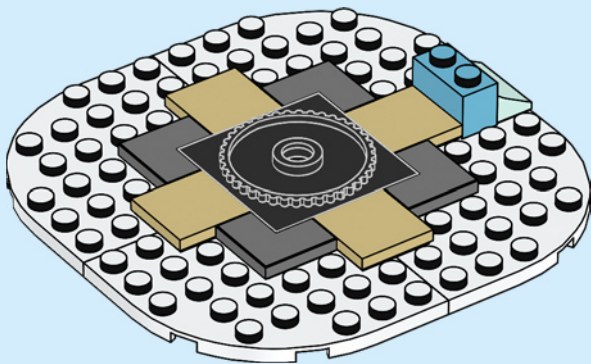



8x

8

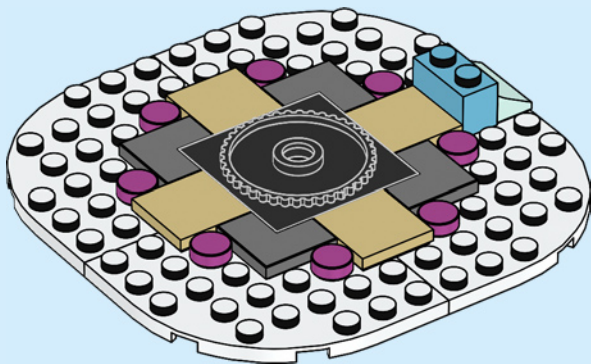



3x



3x

9

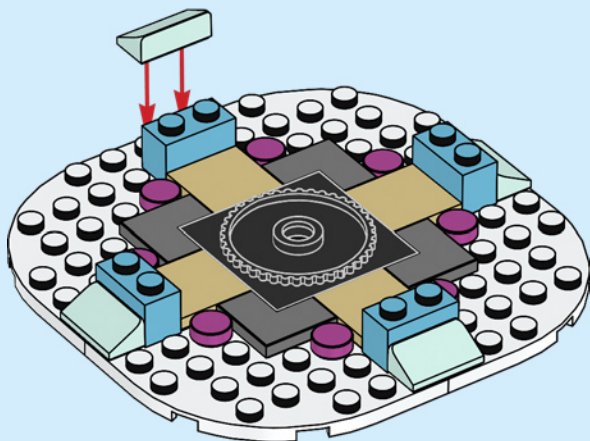



1x

10

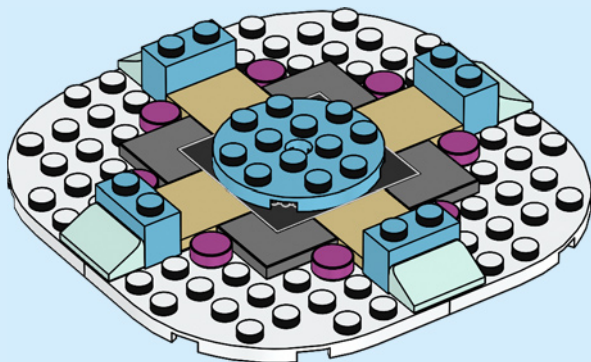



2x



1x

11

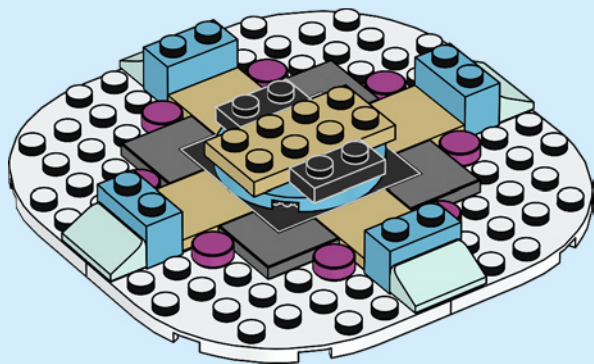



4x

12

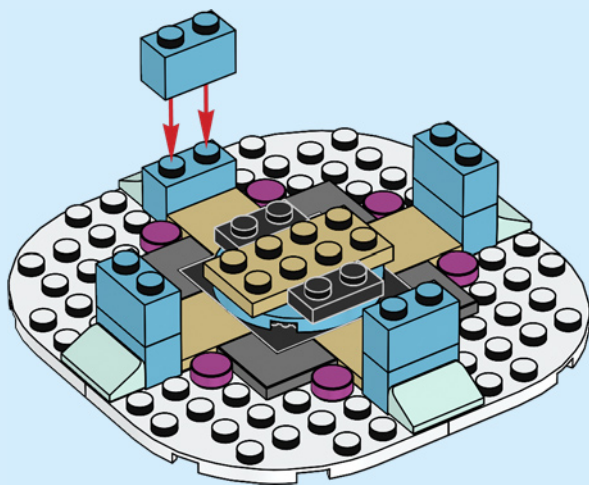



1x

13

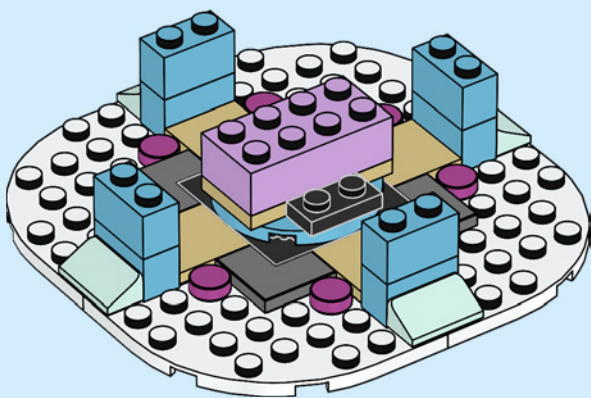



8x

14

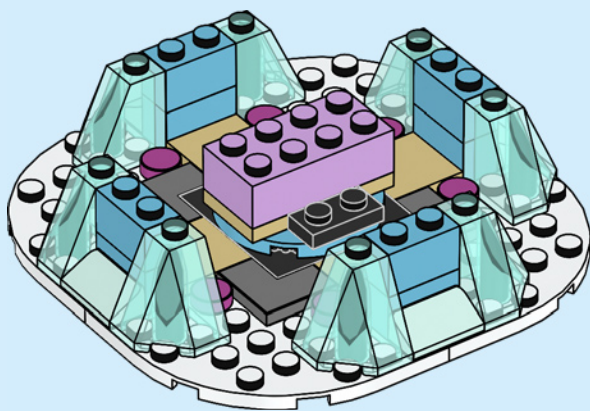



8x

15

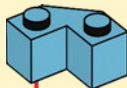

4x

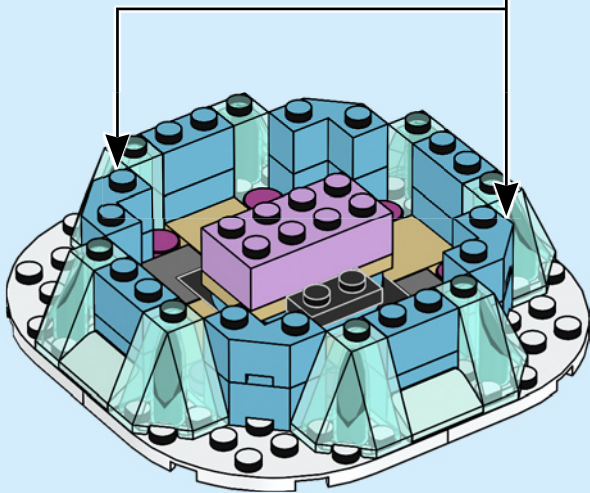



2x

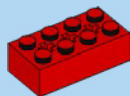

1x

16

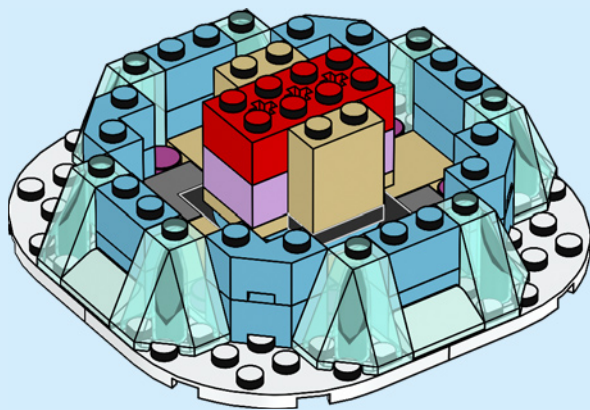



4x

17

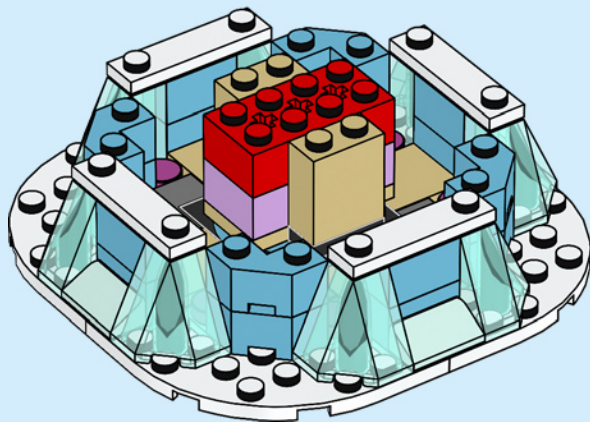



4x

18

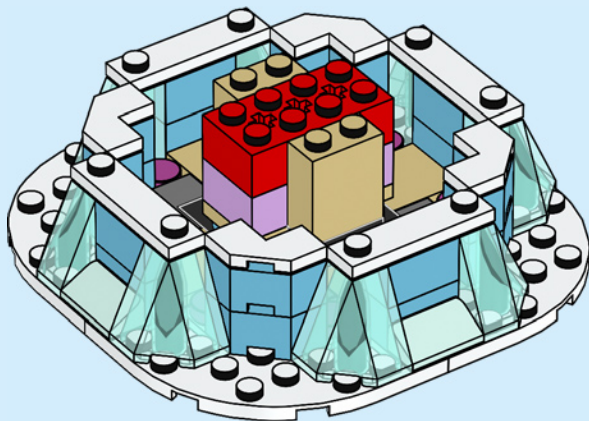

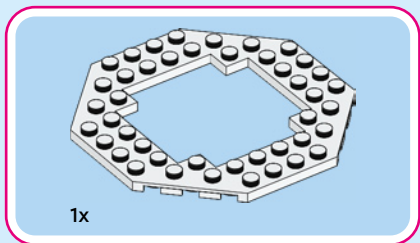

19

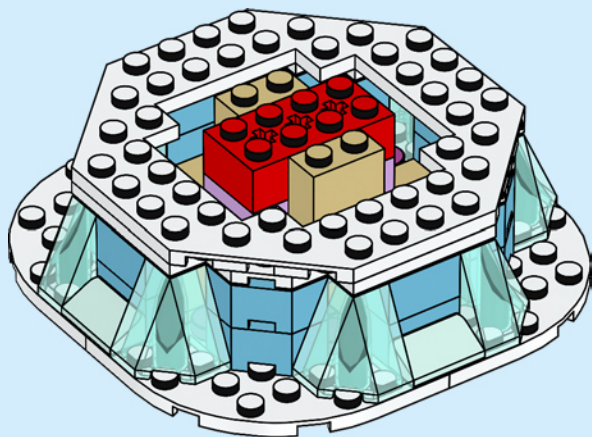

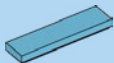

4x

20

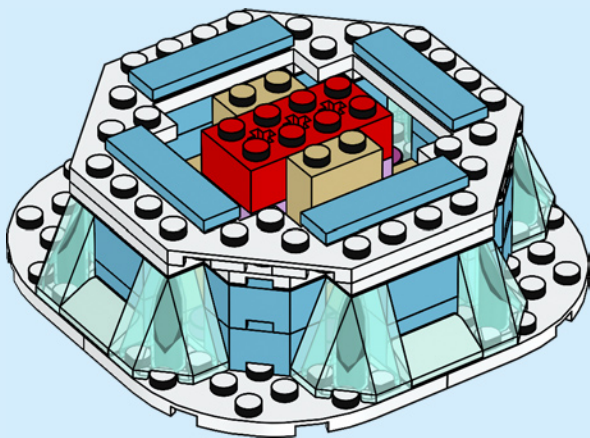



4x

21

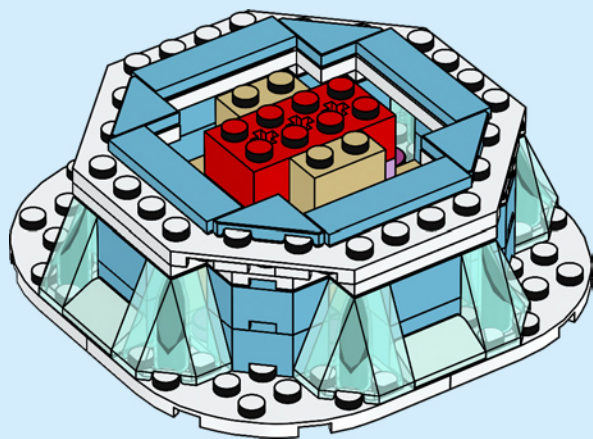



1x

22

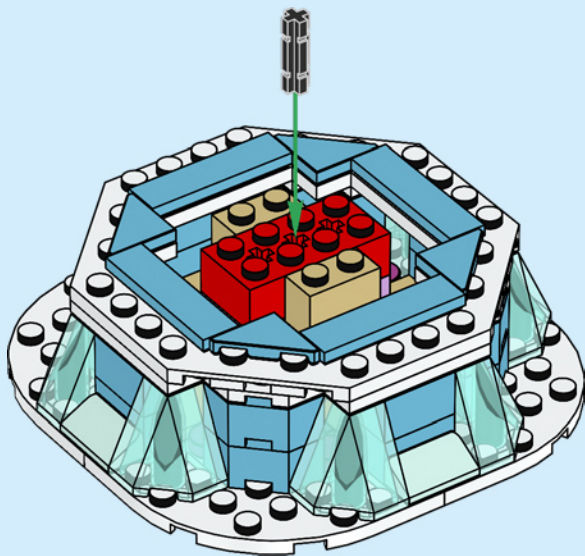

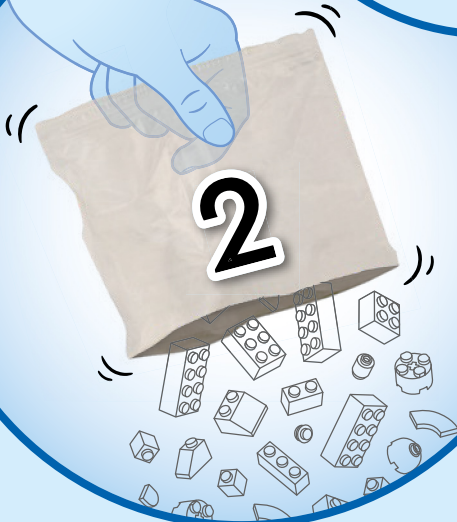
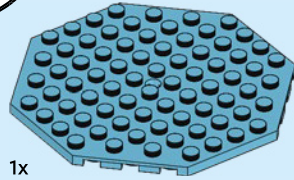
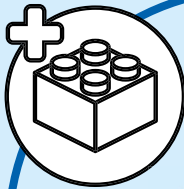

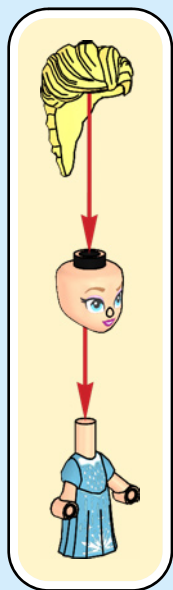

1



2



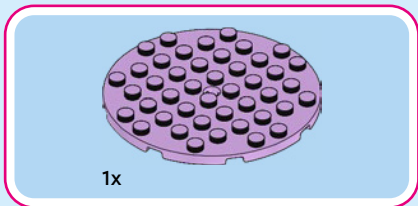
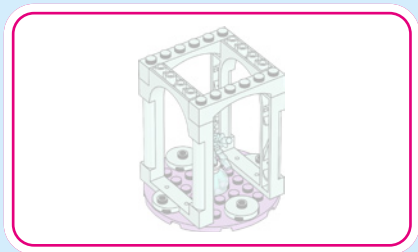

23

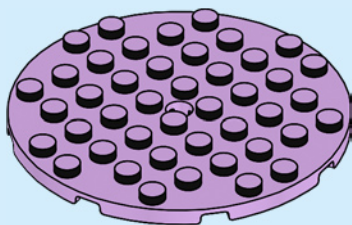



1x



2x

24

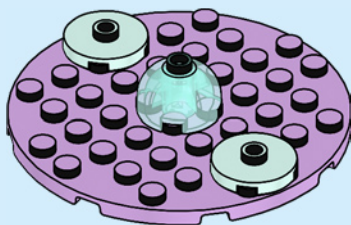



1x

25

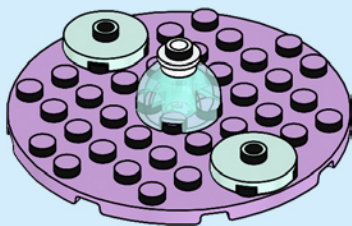



1x

26

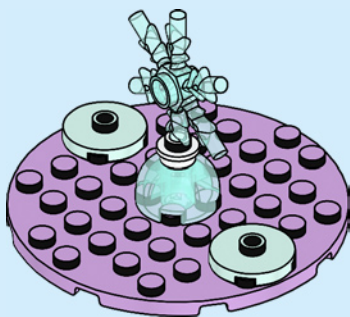



2x

27



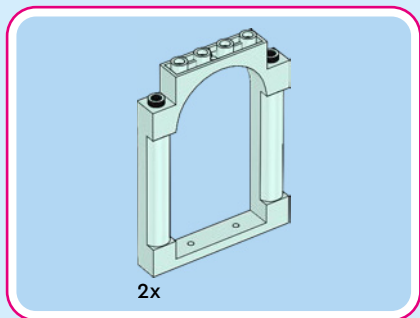

28

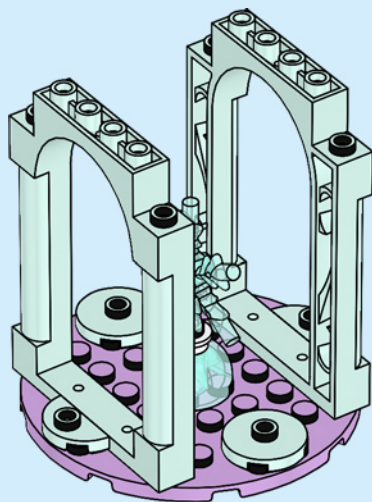

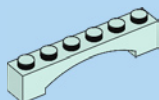

2x

29

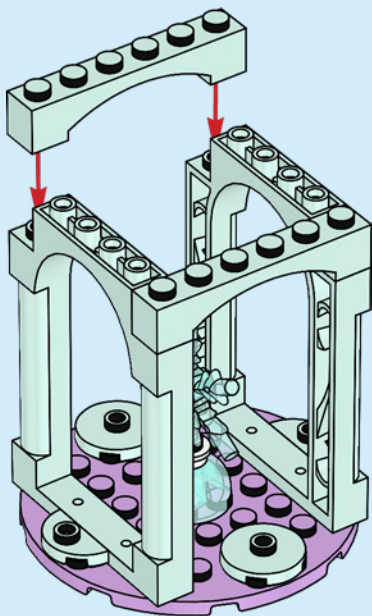

30

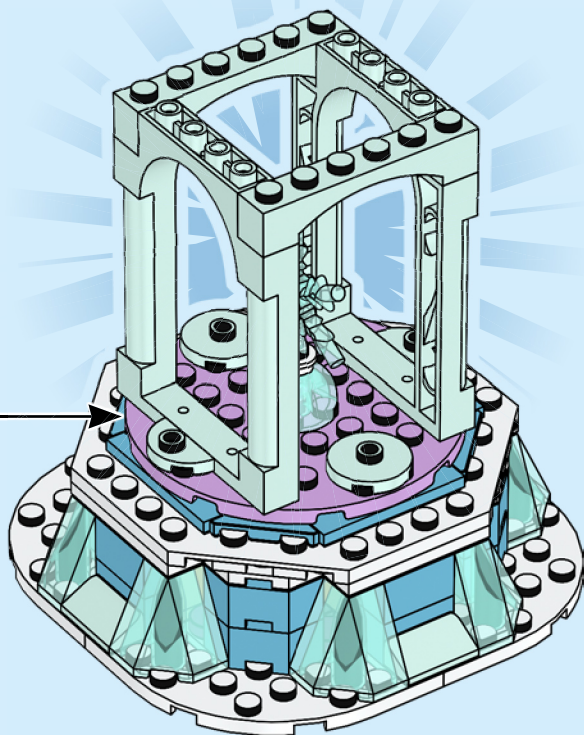

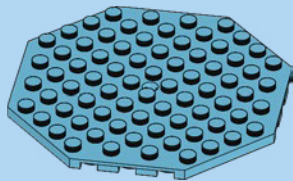

1x

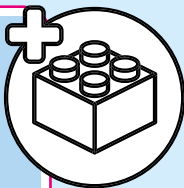

31

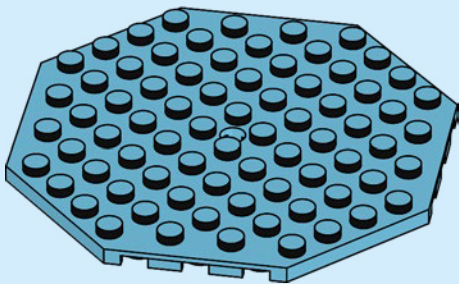



4x

32

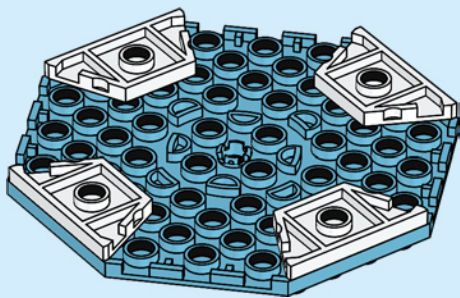



1x



2x



2x

33

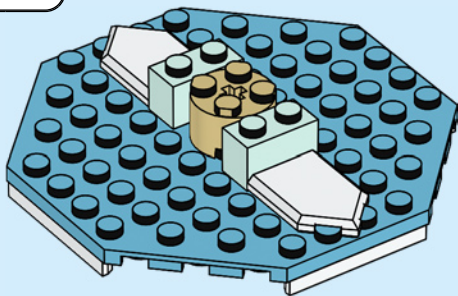

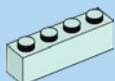

2x



2x

34

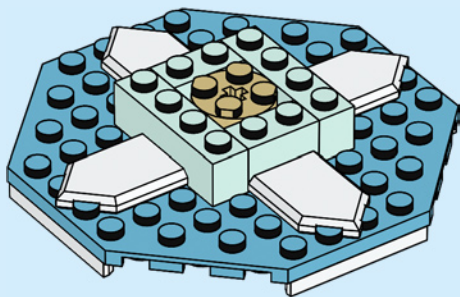



8x

35

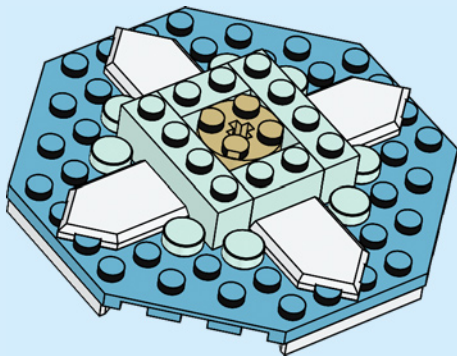



4x

36

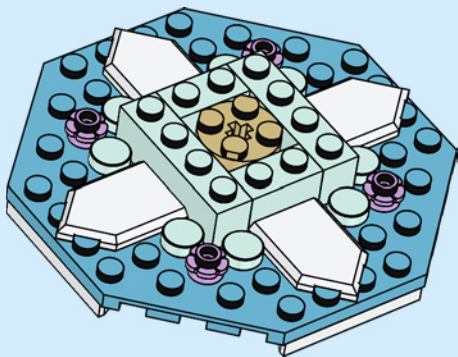



1x

37

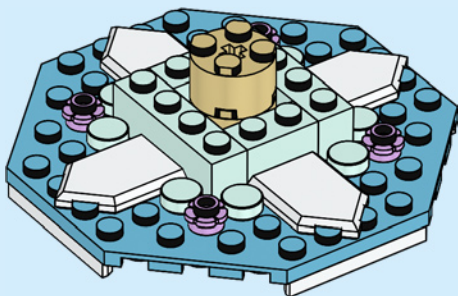



4x

38

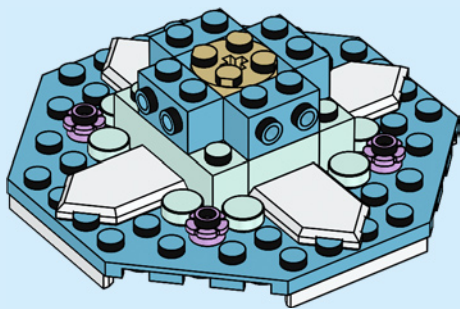



4x

39

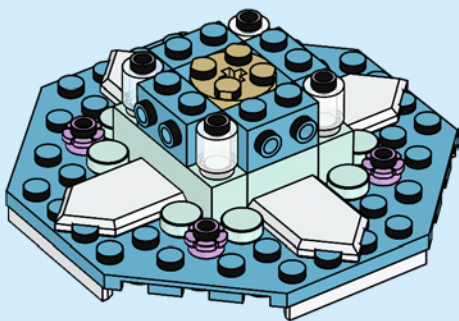



4x

40

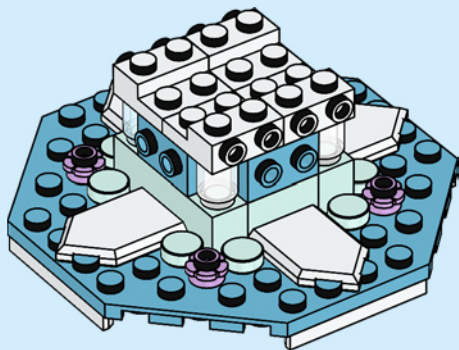



1x

41

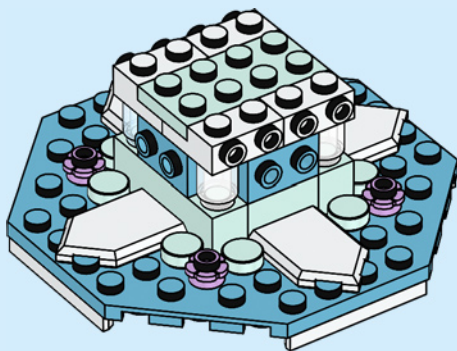



4x

42

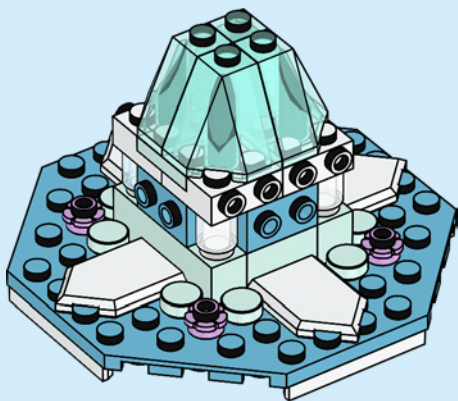



1x

43

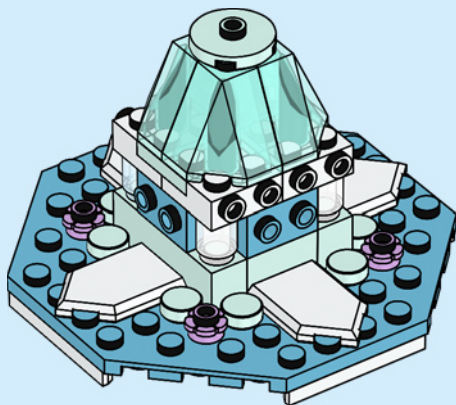



4x

44



4x

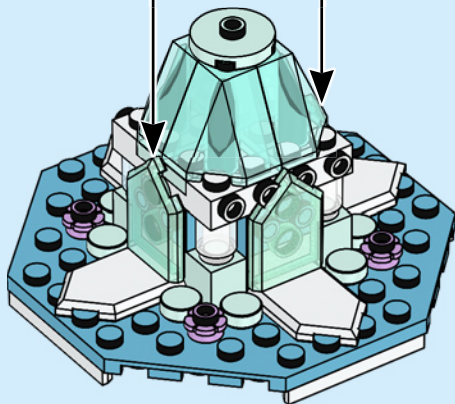



4x

45



4x

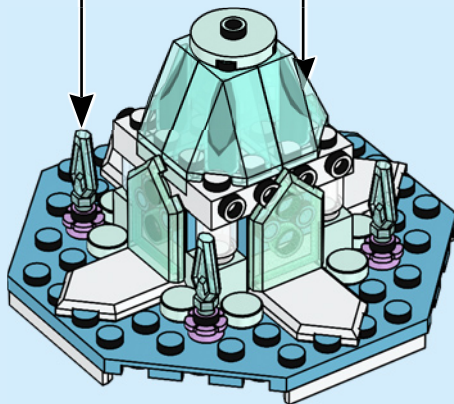

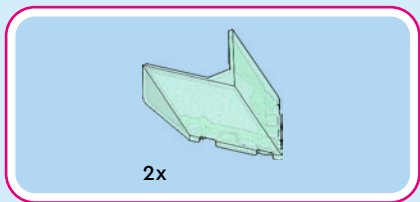

46

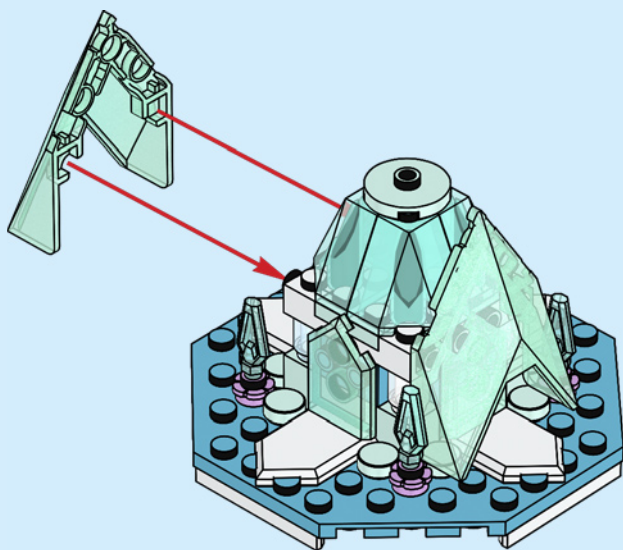



1x



1x

47

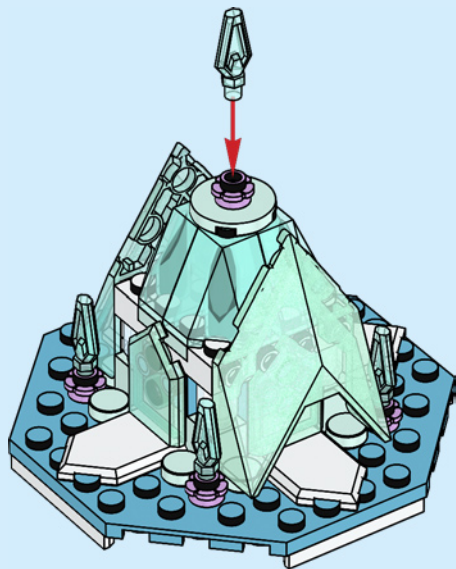

48

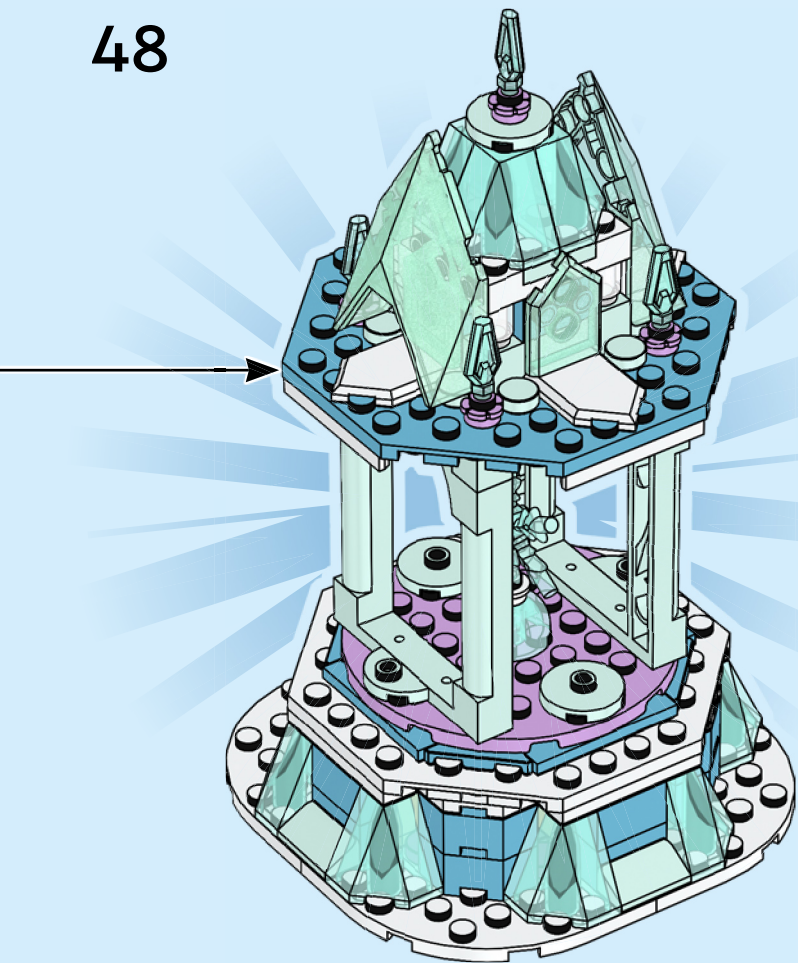





Rebuild
the
world™





4x
6168612



4x
6249091



4x
6046979



1x
6168642



4x
4249506



4x
6057460

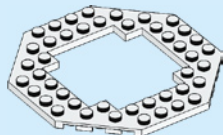

1x
6357951



1x
6274760



1x
6345838



4x
6276148



4x
6245249

66



2x
4159279



2x
4125220



4x
4185177



1x
4114309



1x
6093519



1x
6244918



2x
302326



1x
4109810



1x
4517986



1x
6264989



12x
6354153



1x
6278421



5x
6434368



4x
6247784



1x
6097049



1x
6440586



1x
6422028



1x
6440582



4x
6347306



1x
6350461



1x
6384915



1x
6389696



1x
6440617



4x
6075287



2x
6433946



1x
6345847



1x
6192792



1x
6294565



1x
6250075



8x
6322816



1x
6451631



1x
6440610



8x
6092674



4x
6348142



8x
6356108



4x
6347670



4x
4624705



1x
6102828

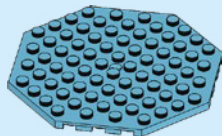

1x
6189082



2x
6022032



2x
6218162



4x
4616211



2x
6287497



1x
6138662



8x
6322818



2x
6445946



3x
6393567

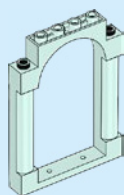

2x
6450963



5x
6214235



4x
6363601

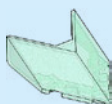

2x
6343874



4x
6339228



1x
6426723

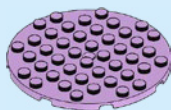

1x
6331523



[LEGO.com/service](https://www.LEGO.com/service)

YOU COULD

WIN



Scan this QR code or go to
LEGO.COM/PRODUCTFEEDBACK
and give us your short feedback
about this LEGO® set for a chance
to win a cool LEGO prize.

Terms and Conditions apply*

EN: YOU COULD WIN. Terms and Conditions apply* **DE: Du könntest GEWINNEN.** Es gelten die Teilnahmebedingungen* **FR: Tu pourrais GAGNER.** Des conditions s'appliquent* **IT: Potresti VINCERE tu.** Termini e condizioni sono applicabili* **ES: Puedes GANAR.** Aplican términos y condiciones* **PT: Poderá GANHAR.** Aplicam-se termos e condições* **ZH: 轻松获奖. 条款和条件适用*** **PL: Szansa na WYGRANĄ.** Obowiązują warunki korzystania* **CS: Máte šanci VYHRÁT.** Platí všeobecné smluvní podmínky* **SK: Máte šancu VYHRAŤ.** Platia všeobecné zmluvné podmienky* **HU: TE IS NYERHETSZ.** Felhasználási feltételek érvényesek* **RO: Ai putea CÂȘTIGA.** Se aplică termeni și condiții* **BG: Можете да СПЕЧЕЛИТЕ.** Има определени правила и условия* **LV: Tu vari LAIMĒT.** Ir spēkā noteikumi un nosacījumi.* **ET: Sul on võimalus VÕITA.** Kehtivad tingimused* **LT: Jūs galite LAIMĖTI.** Taikomos sąlygos*

*[LEGO.com/productfeedback-terms](https://www.lego.com/productfeedback-terms)