



CITY

60383





LEGO.com/sustainable-packaging



BUILDER



Apple and the Apple logo are trademarks of Apple Inc., registered in the U.S. and other countries and regions. App Store is a service mark of Apple Inc. Google Play and the Google Play logo are trademarks of Google LLC. Tencent and the Tencent logo are trademarks of Tencent Inc.

 [LEGO.com/devicecheck](https://www.lego.com/devicecheck)

EN Ask parents' permission before going online | **DE** Eltern um Erlaubnis bitten, bevor du online gehst | **FR** Demande l'autorisation d'un parent avant d'aller en ligne | **IT** Chiedi il permesso ai tuoi genitori prima di andare online | **ES** Pídeles permiso a tus papás antes de conectarte a Internet | **PT** Pede autorização aos pais antes de acederes online | **JA** オンラインになる前に ほご者の方のきよかをもらおう | **ZH** 上网前应先征得父母的同意 | **KO** 온라인 접속 전에 보호자 동의가 필요합니다 | **RU** Спроси разрешения у родителей, прежде чем заходить в интернет | **PL** Poproś rodziców o zgodę, zanim wejdiesz do Internetu | **CS** Než půjdeš na internet, požádej rodiče o svolení | **SK** Skôr než pôjdeš na internet, vypýtaj si povolenie od rodičov | **HU** Kérj szülői engedélyt, mielőtt online csatlakoznál! | **RO** Cere permisiunea părinților înainte de a te conecta online | **BG** Поискайте разрешение от родители, преди да влезете онлайн | **LV** Pirms došanās tiešsaistē palūdz atļauju vecākiem | **ET** Enne Interneti kasutamist küsi vanematelt luba | **LT** Prieš prisijungdami prie interneto, atsiklauskite tėvų





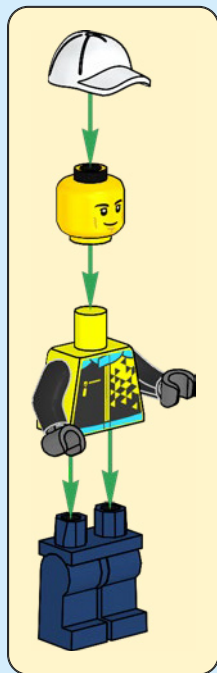

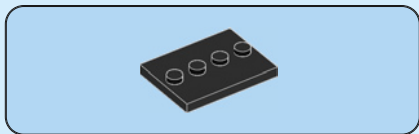
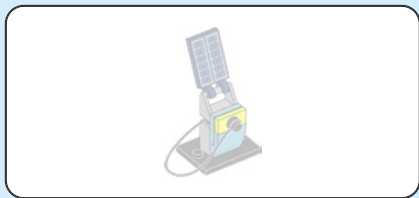

1

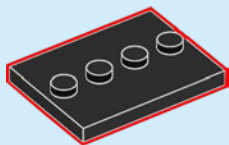

6



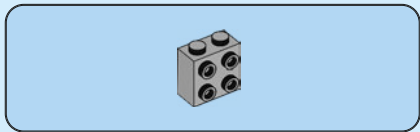

2

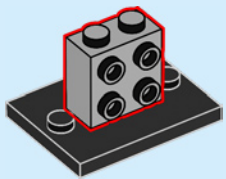

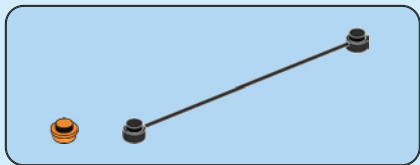

3

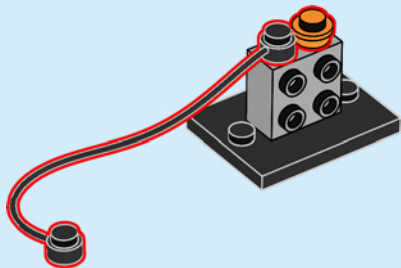

8



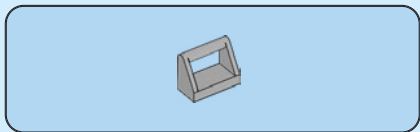

4

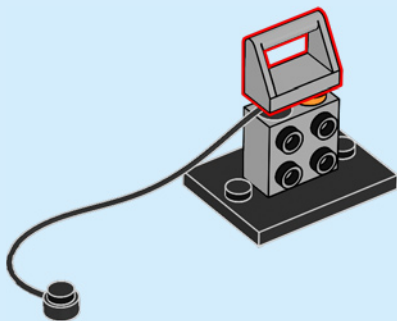

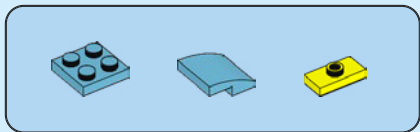

5

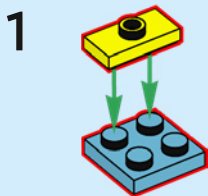

2

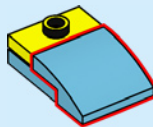

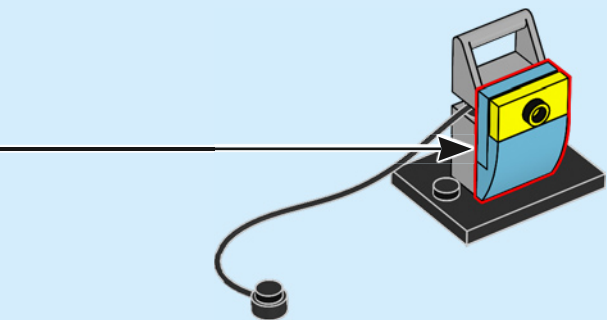

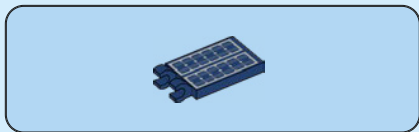

6

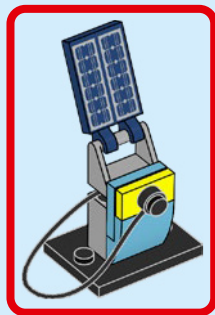
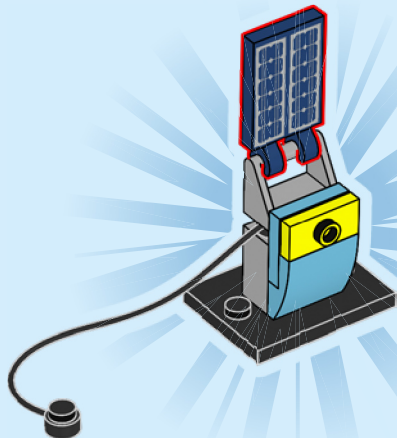

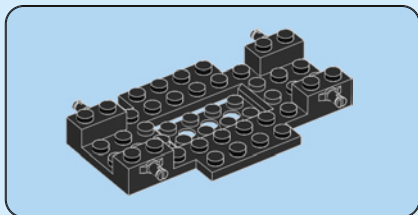
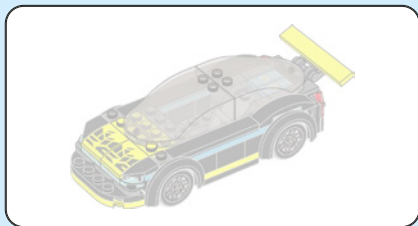

1

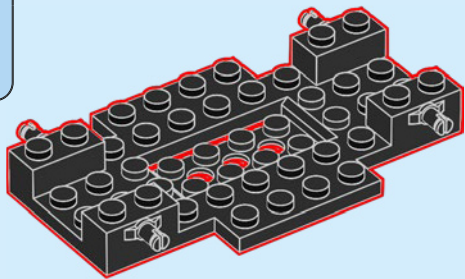



2

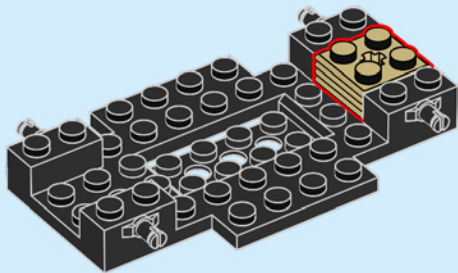

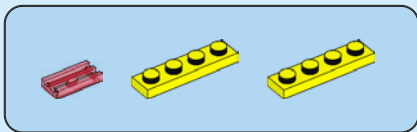

3

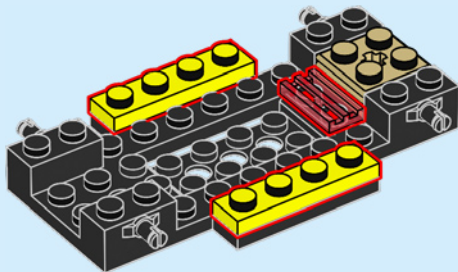

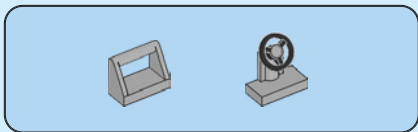

4

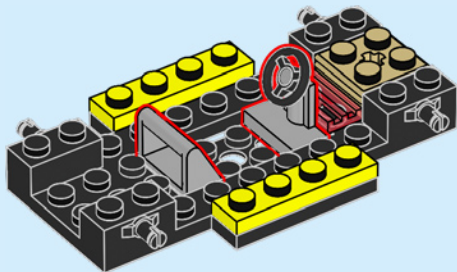

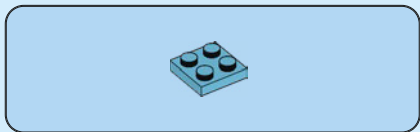

5

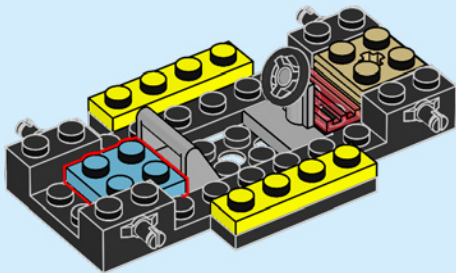



6

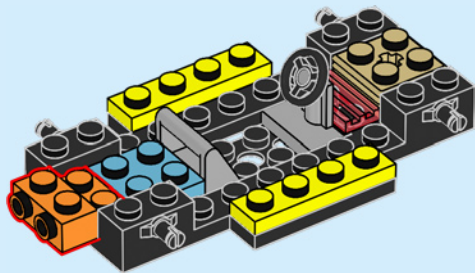

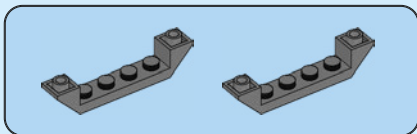

7

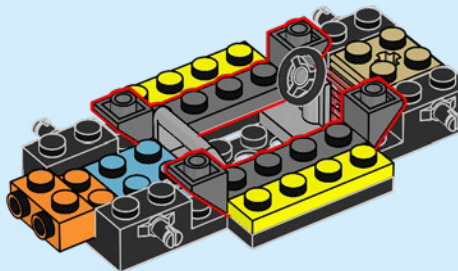



8

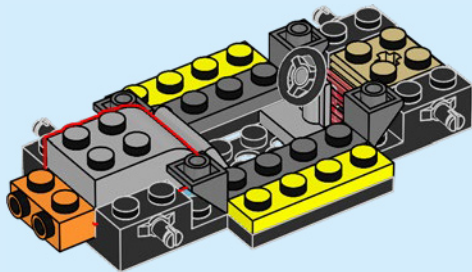

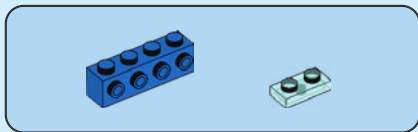

9

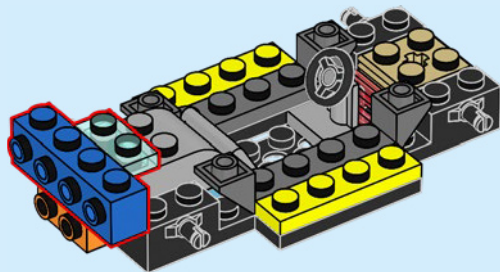

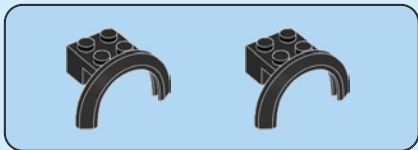

10

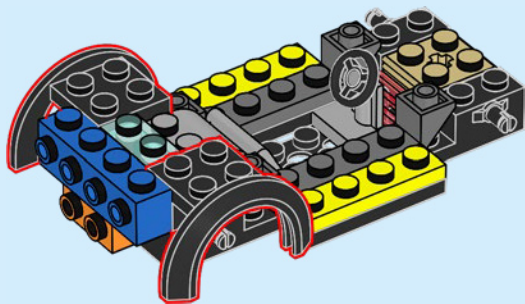

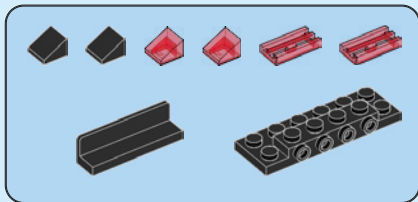

11

1

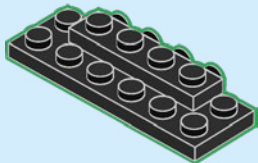

2

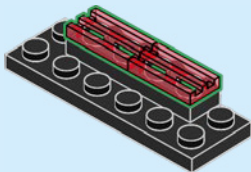

3

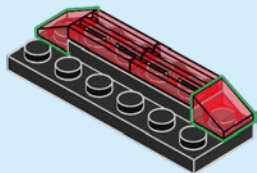

4

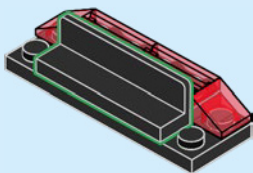

5

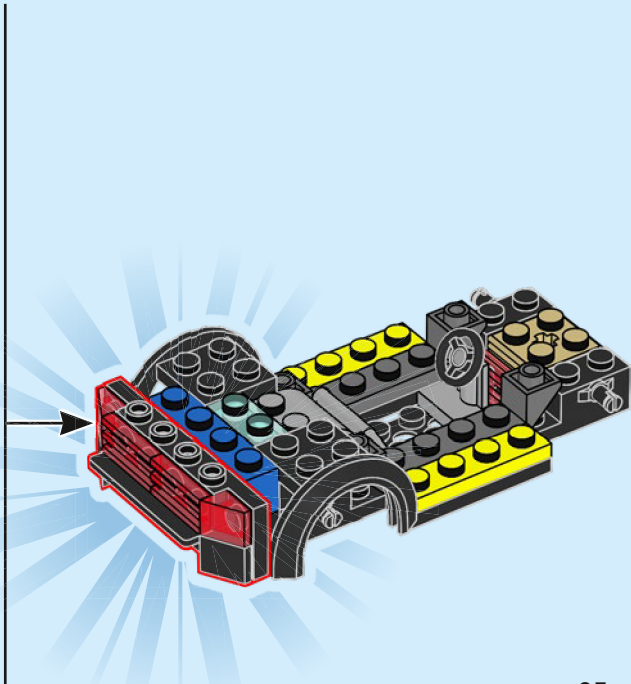
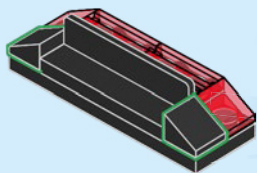

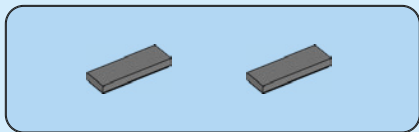

12

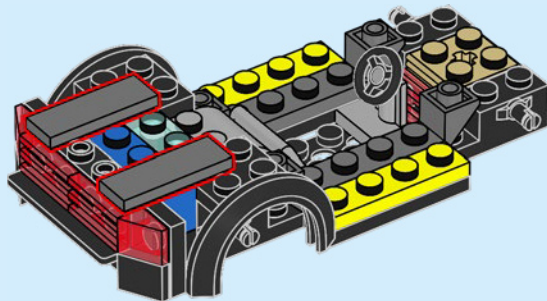



13

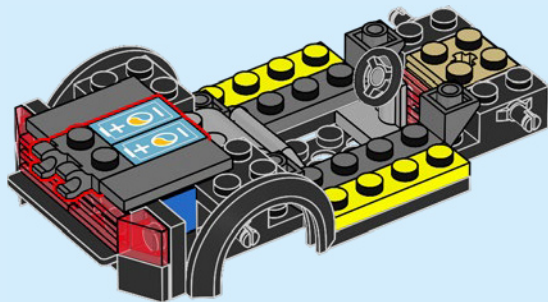

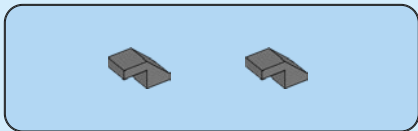

14

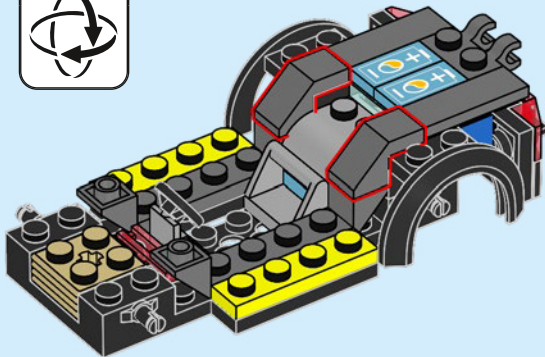

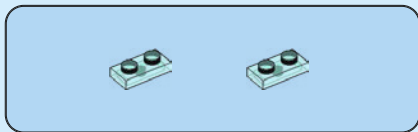

15

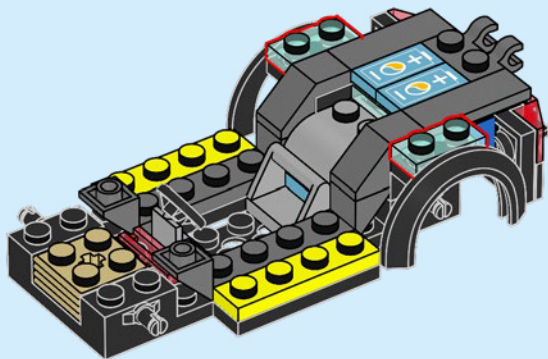

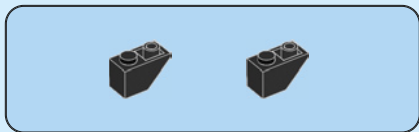

16

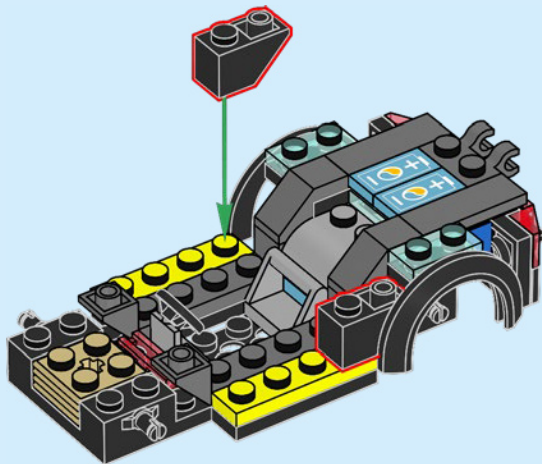

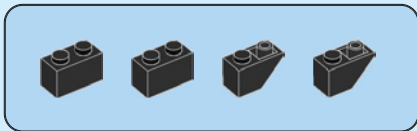

17

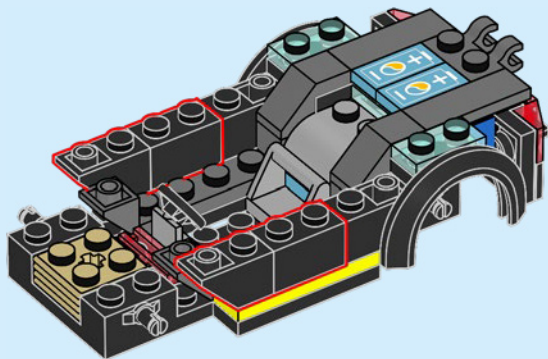

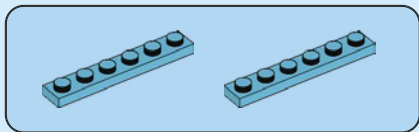

18

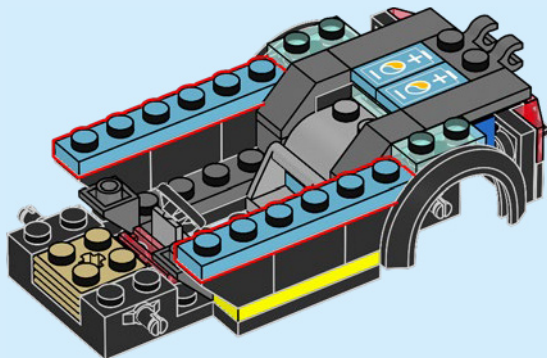

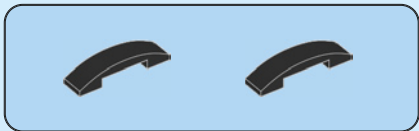

19

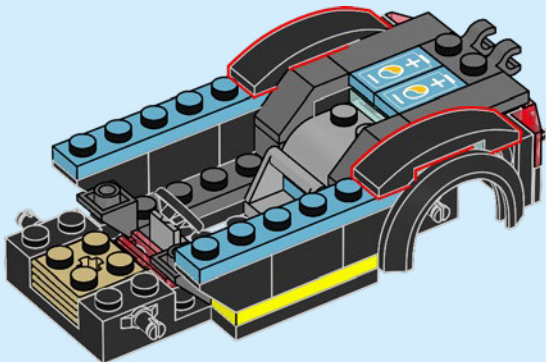



20

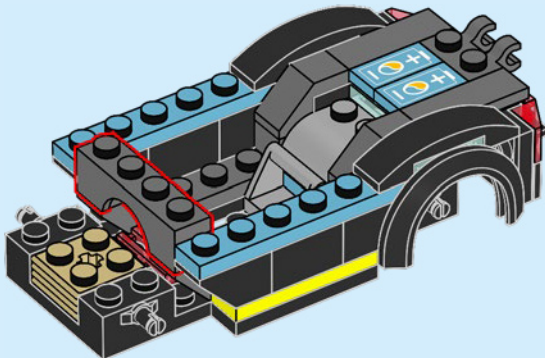



21

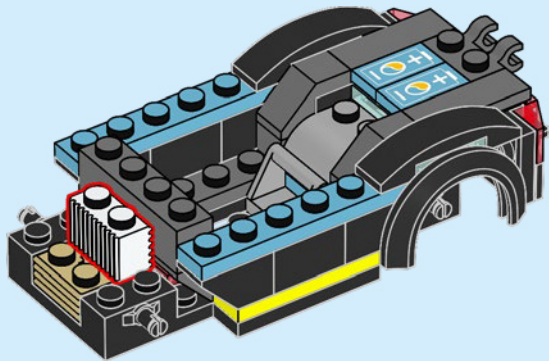

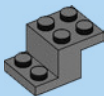

22

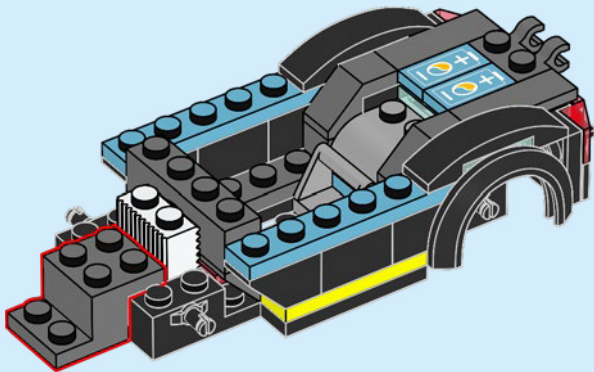

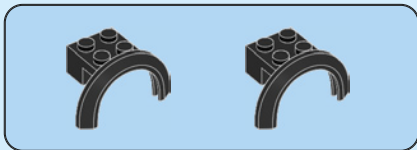

23

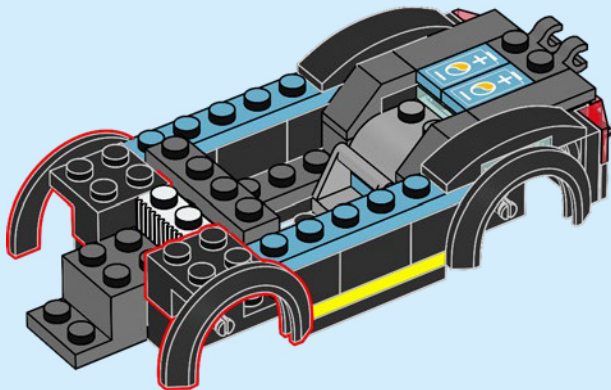

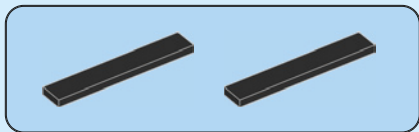

24

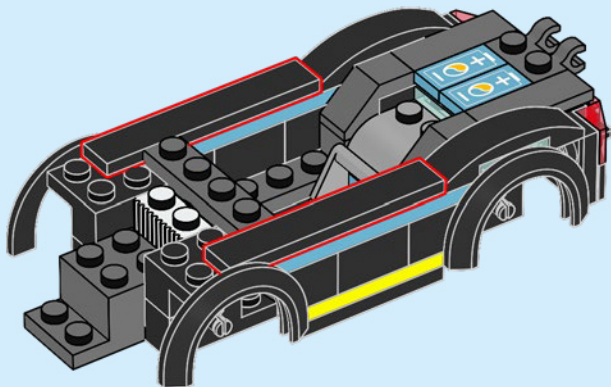



25

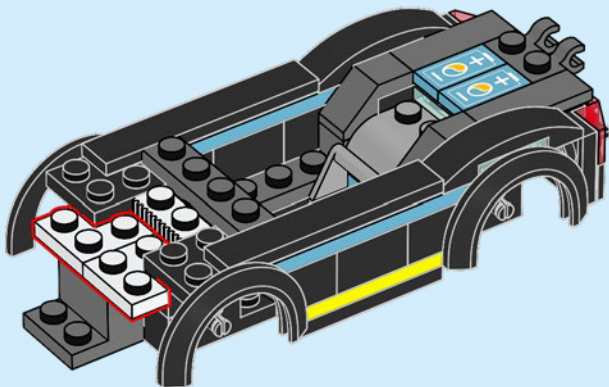



26

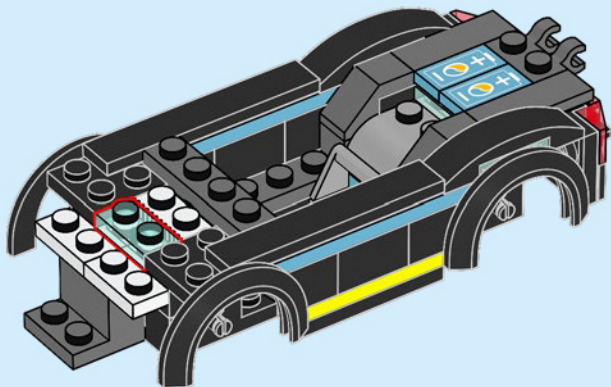

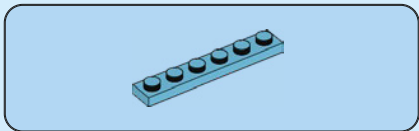

27

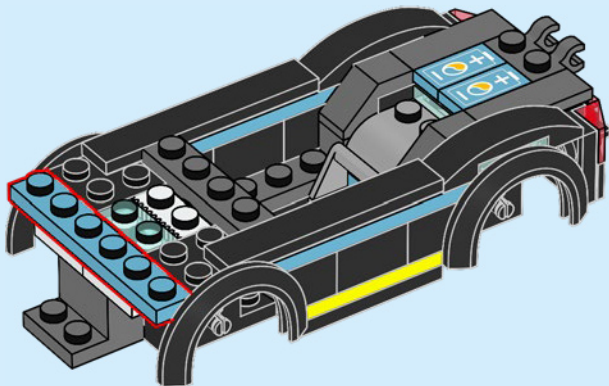

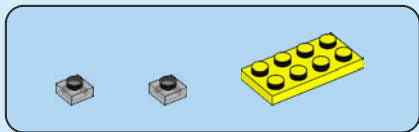

28

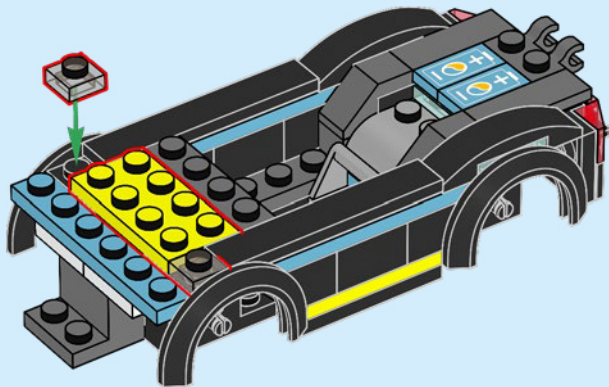

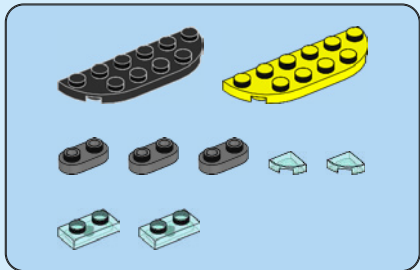

29

1

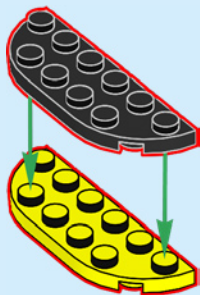

2

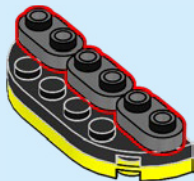

3

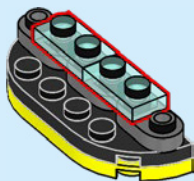

4

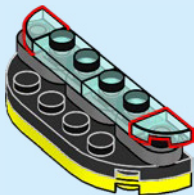

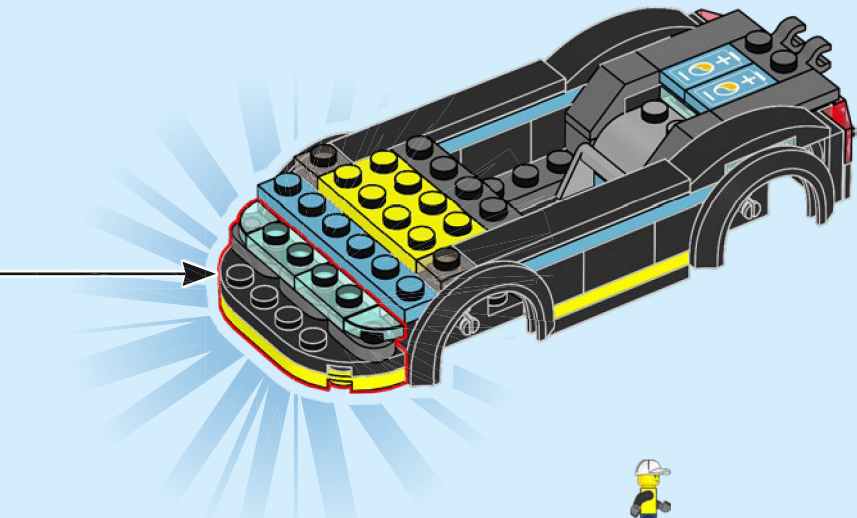

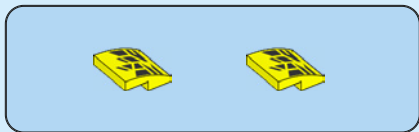

30

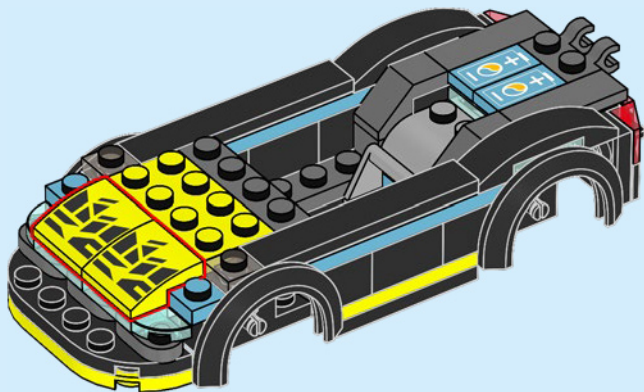

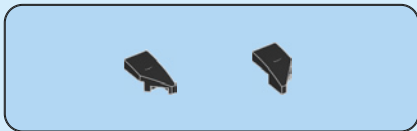

31

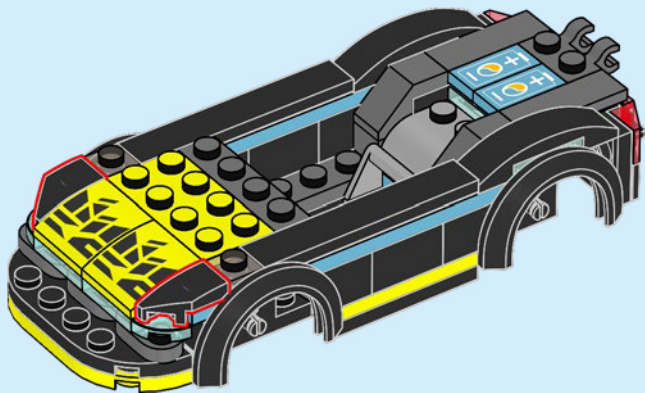

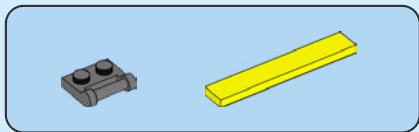

32

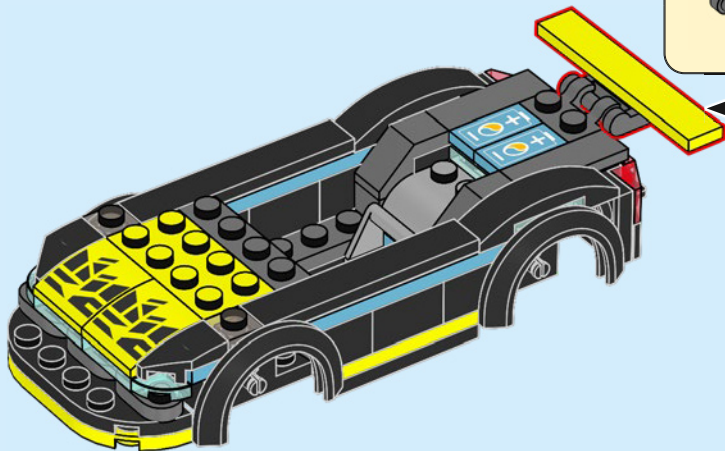
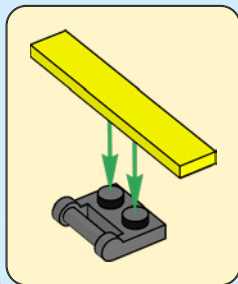

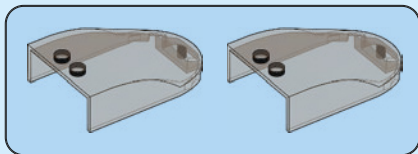

33

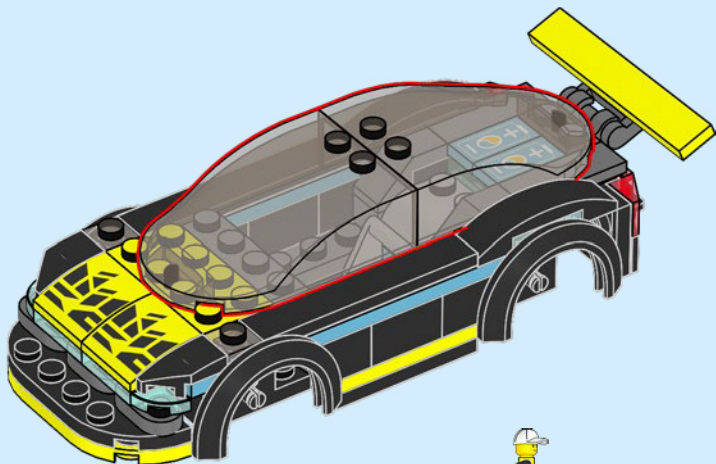

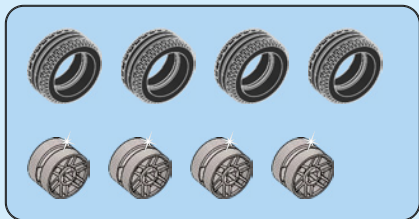

34

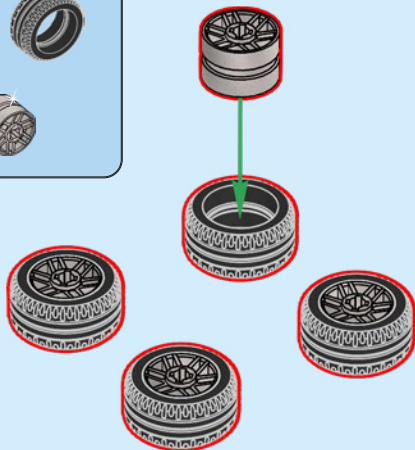

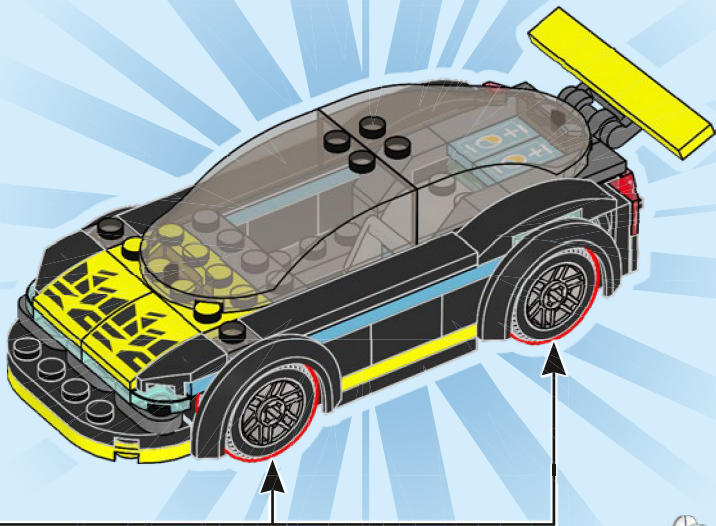

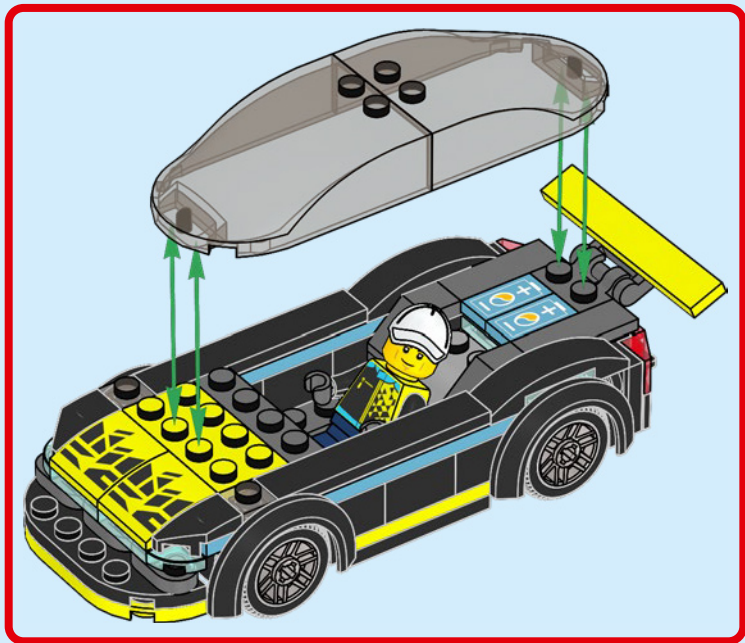

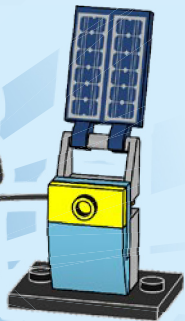
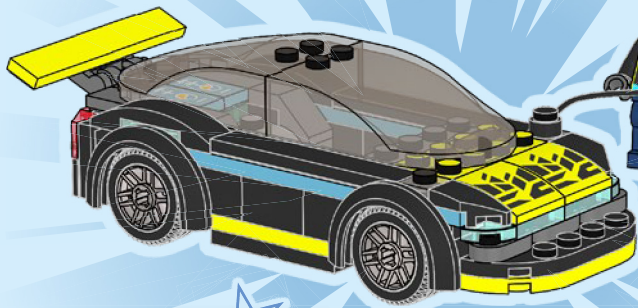



2x
4504382



4x
366526



1x
6092570



2x
6245252



1x
6283875



1x
6181720



2x
300426



3x
6250158



1x
6019165



1x
6181713



2x
4613153

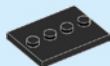

1x
6076678



1x
4157103



1x
287701



1x
4226995



1x
6105963

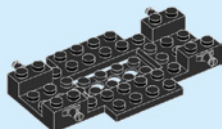

1x
6285534



1x
6289113



2x
242001



4x
6029208



2x
663626



1x
4212411



2x
6396287



4x
4260488

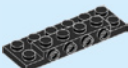

1x
6401209



1x
6096955



1x
6330903



6x
6240222



2x
6252039



2x
6244777



1x
4162916



1x
6331694



2x
4211357



1x
6123809



1x
4217918



3x
6221607



2x
6168776



1x
6350292



1x
6146321



2x
4568734



1x
6395363



1x
4210999



2x
4294180



4x
6218226



2x
6421752



2x
4625032



1x
6119126

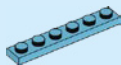

3x
4625036



2x
6419128



1x
6422708



2x
6380691



1x
6389819



1x
6388037



1x
6388034



1x
6381739

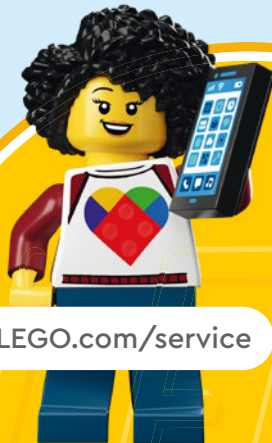

[LEGO.com/service](https://www.LEGO.com/service)

YOU COULD

WIN



Scan this QR code or go to
LEGO.COM/PRODUCTFEEDBACK and give us
your short feedback about this LEGO® set
for a chance to win a cool LEGO prize.

Terms and Conditions apply*

DE: Du könntest GEWINNEN. Es gelten die Teilnahmebedingungen* **FR: Tu pourrais GAGNER.** Des conditions s'appliquent* **IT: Potresti VINCERE tu.** Termini e condizioni sono applicabili* **ES: Puedes GANAR.** Aplican términos y condiciones* **PT: Poderá GANHAR.** Aplicam-se termos e condições* **JA: プレゼント付き! 利用規約が適用されます*** **ZH: 轻松获奖. 条款和条件适用*** **KO: 상품의 주인이 되어보세요. 소정의 약관이 적용됩니다*** **RU: Вы можете ВЫИГРАТЬ.** Действуют положения и условия* **PL: Szansa na WYGRANĄ.** Obowiązują warunki korzystania* **CS: Máte šanci VYHRÁT.** Platí všeobecné smluvní podmínky* **SK: Máte šancu VYHRATĚ.** Platia všeobecné zmluvné podmienky* **HU: TE IS NYERHETSZ.** Felhasználási feltételek érvényesek* **RO: Ai putea CĂȘTIGA.** Se aplică termenii și condiții* **BG: Можете да СПЕЧЕЛИТЕ.** Има определени правила и условия* **LV: Tu vari LAIMĒT.** Ir spēkā noteikumi un nosacījumi.* **ET: Sul on võimalus VÕITA.** Kehtivad tingimused* **LT: Jūs galite LAIMĖTI.** Taikomos sąlygos*

*[LEGO.com/productfeedback-terms](https://www.lego.com/productfeedback-terms)

LEGO and the LEGO logo are trademarks of the LEGO Group.

©2023 The LEGO Group.

6444302