

121

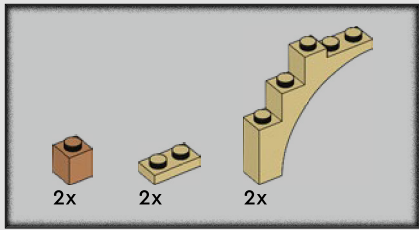

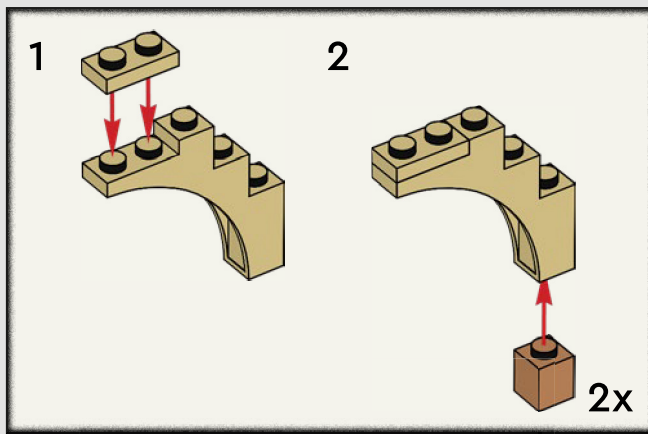

122



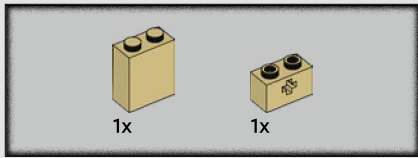

123

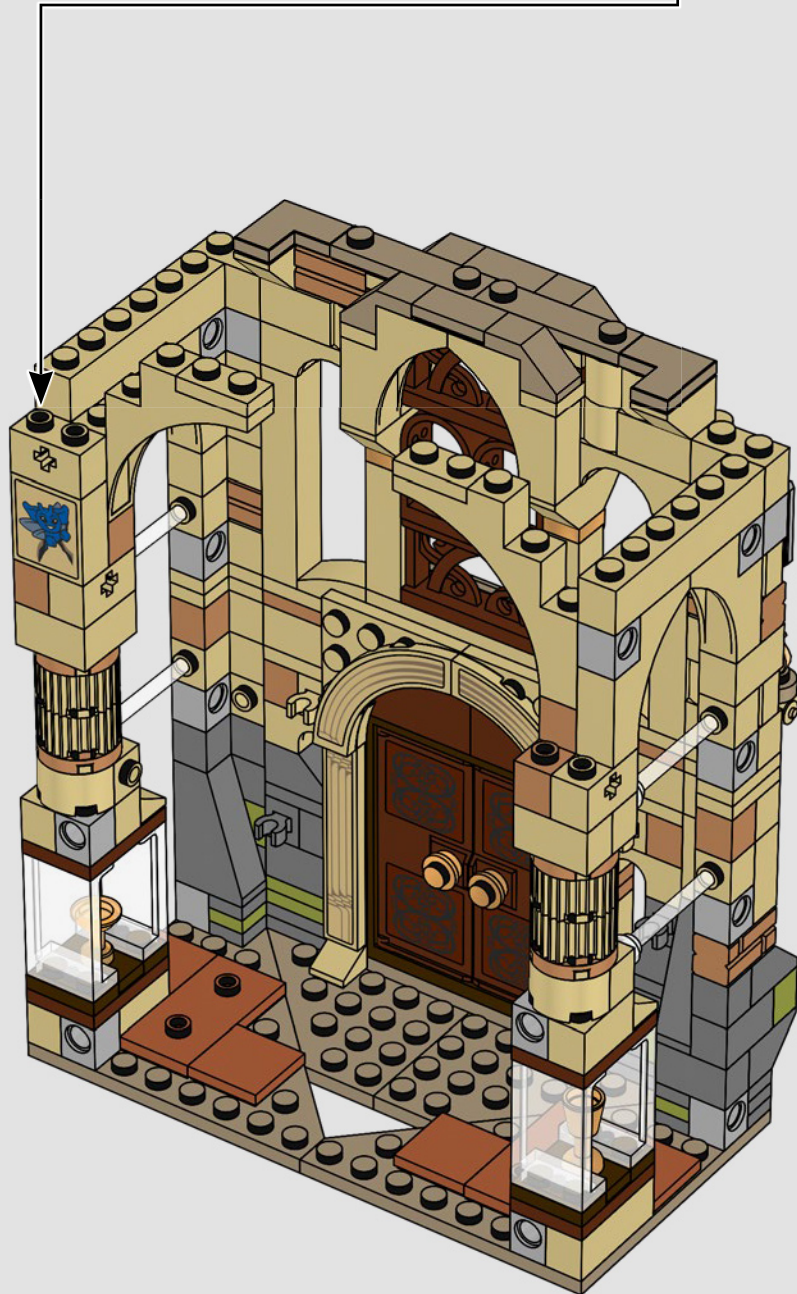
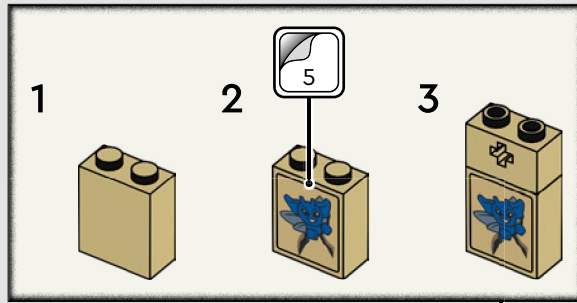

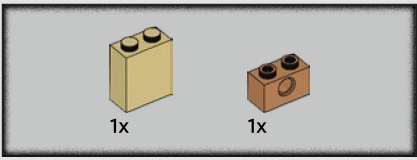

124

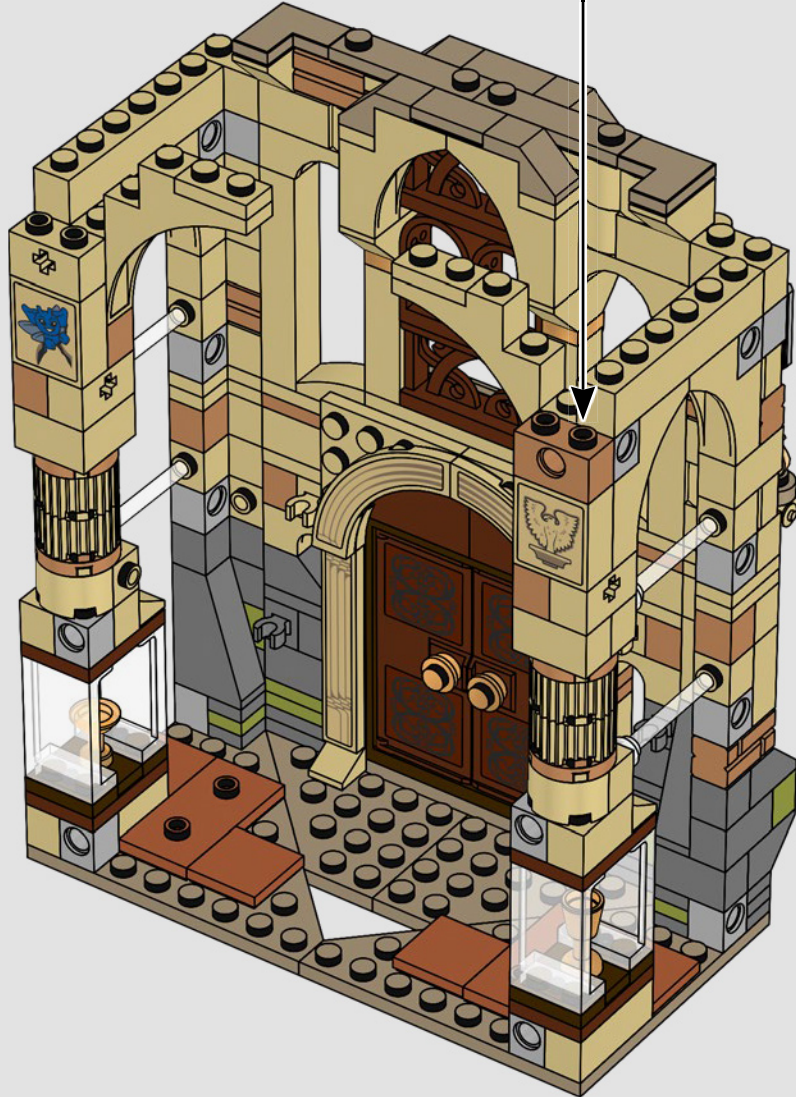
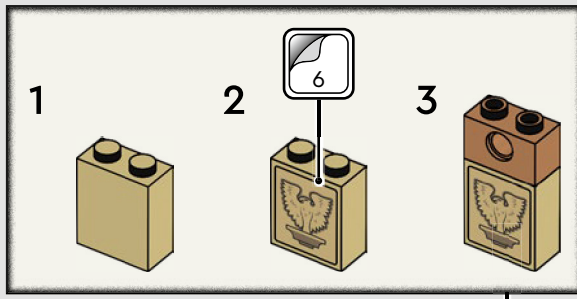

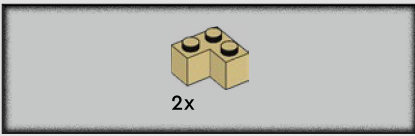

125

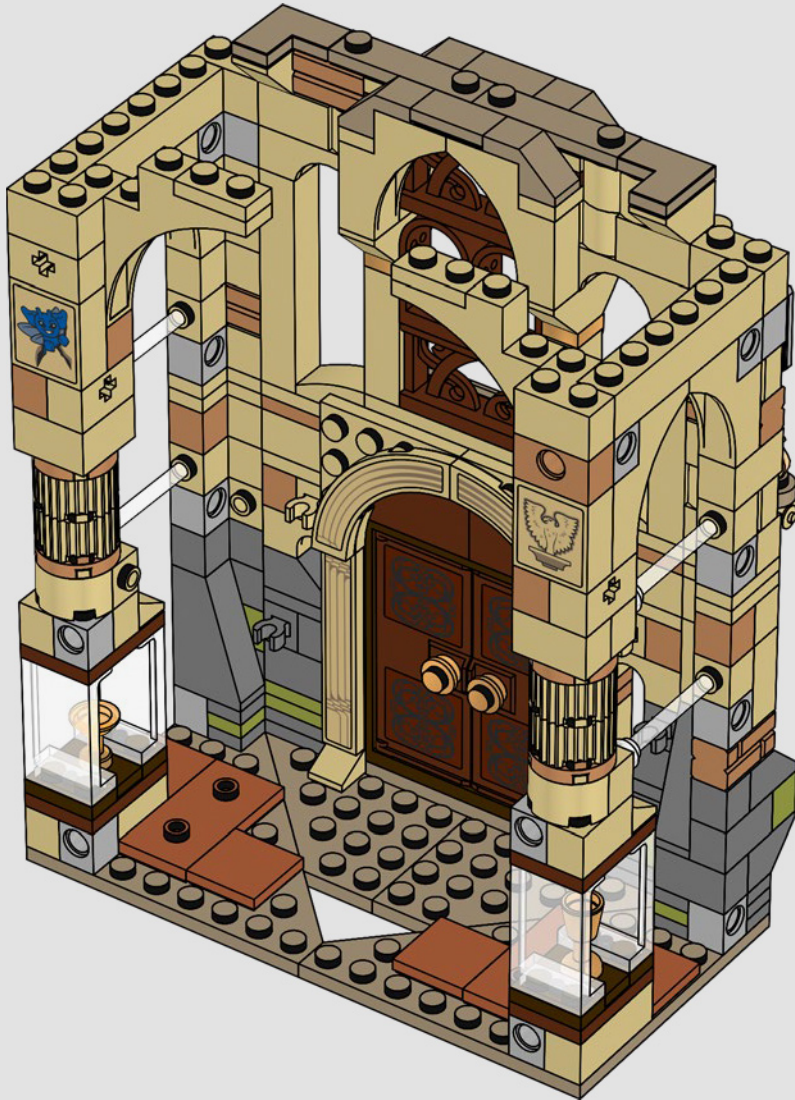

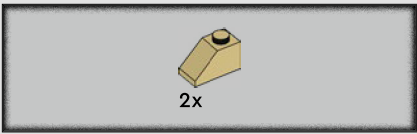

126

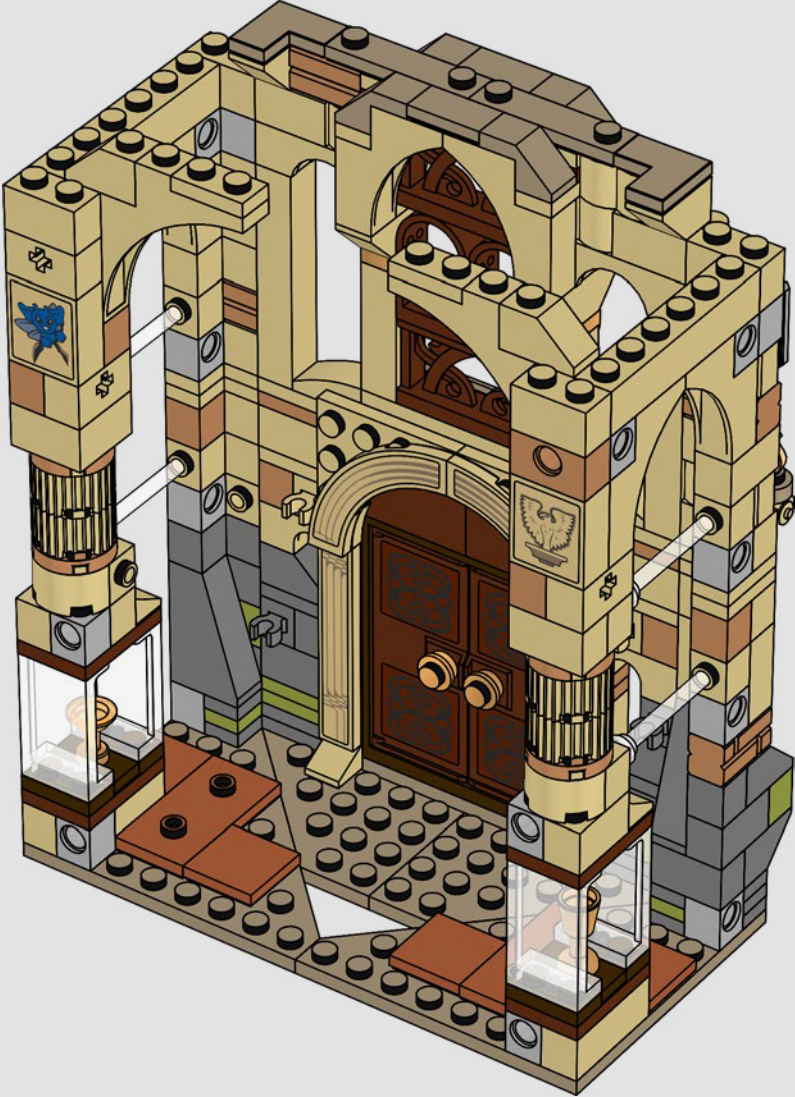

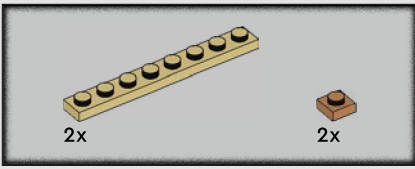

127



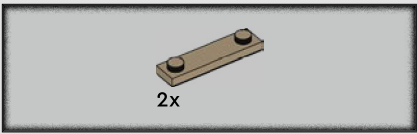

128

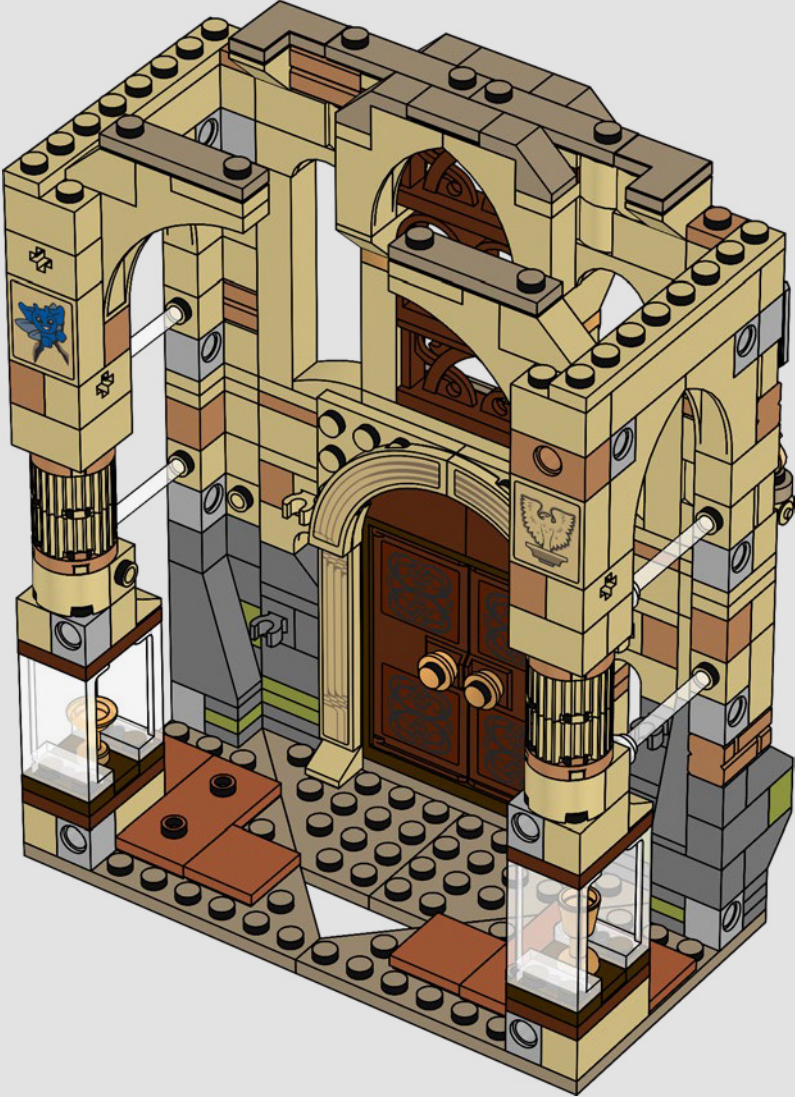

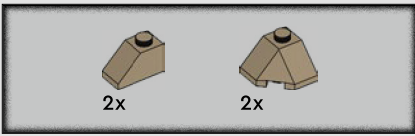

129

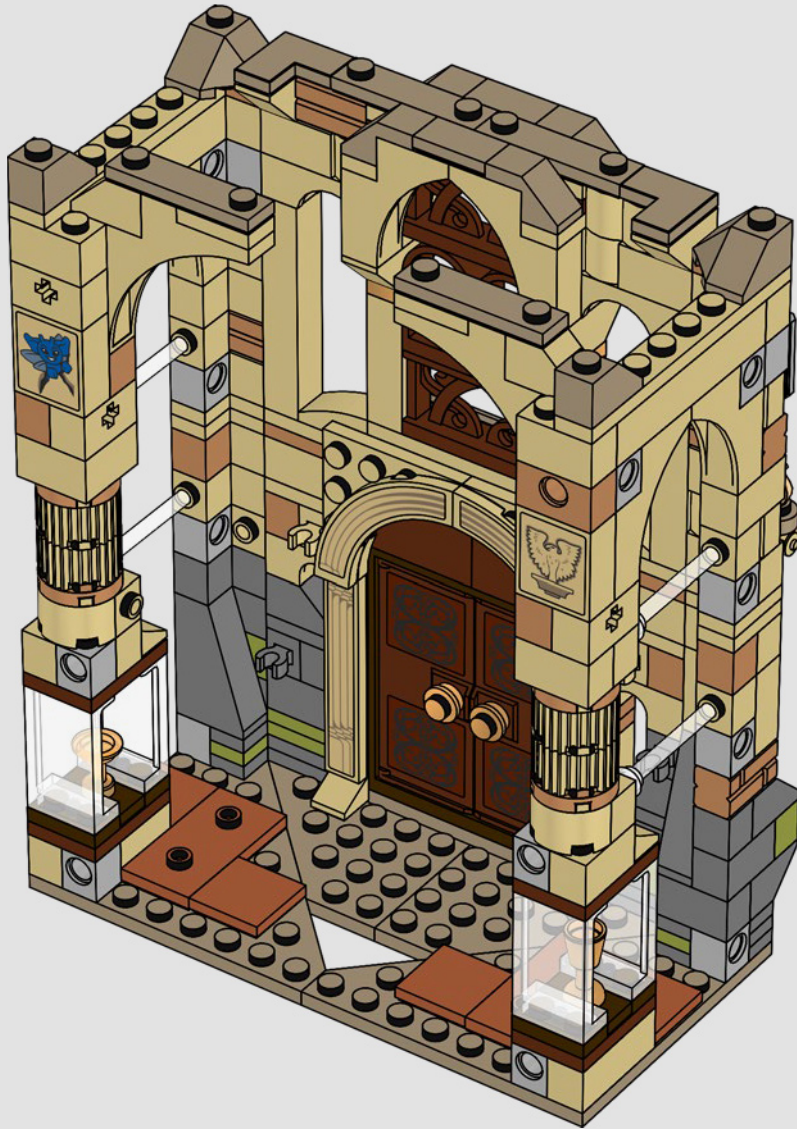

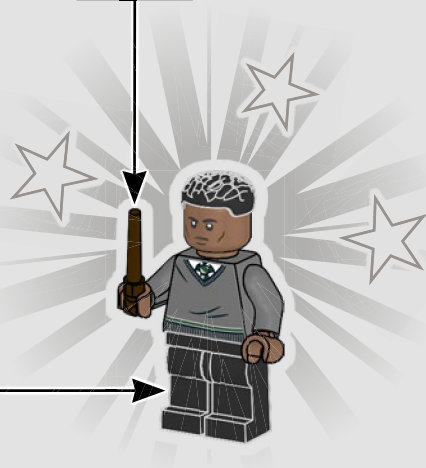
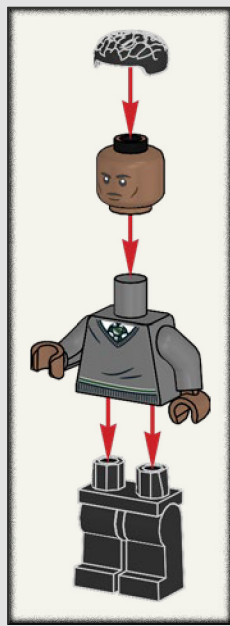

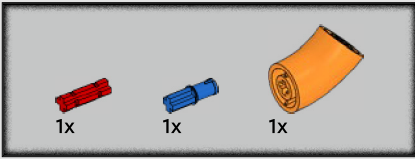
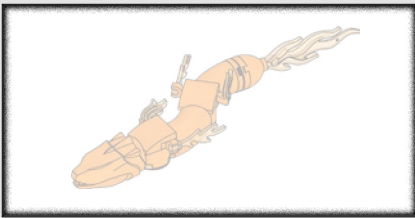

1

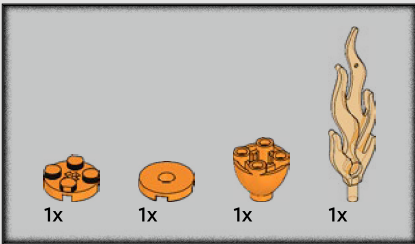
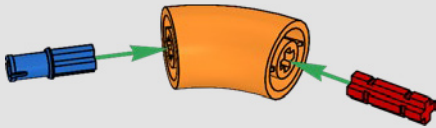

2

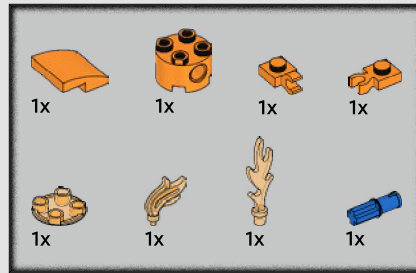
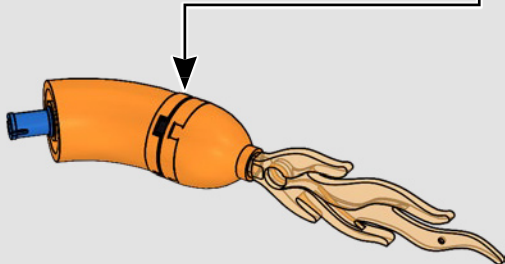
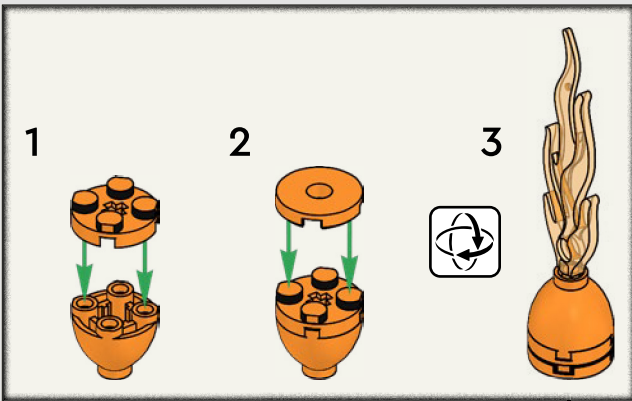

3

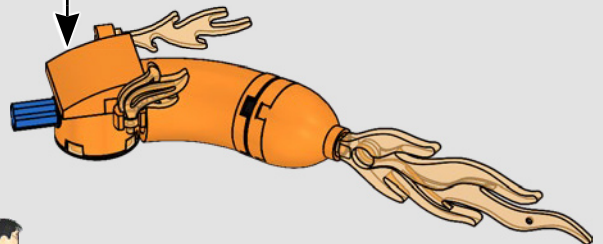
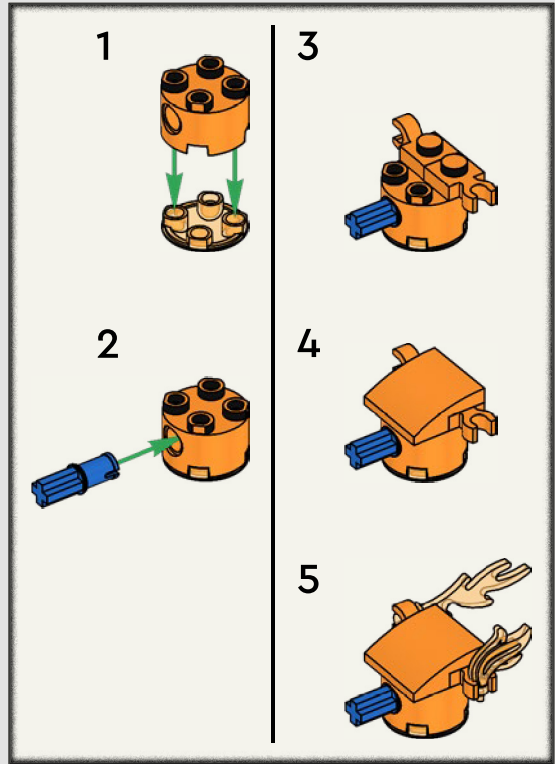

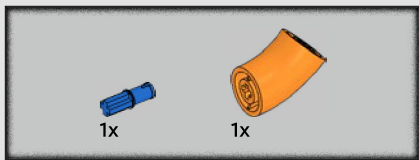

4

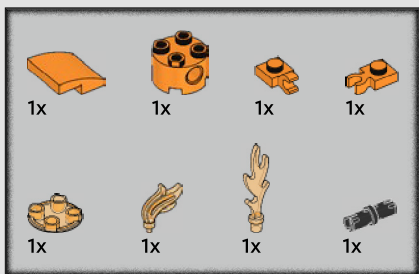
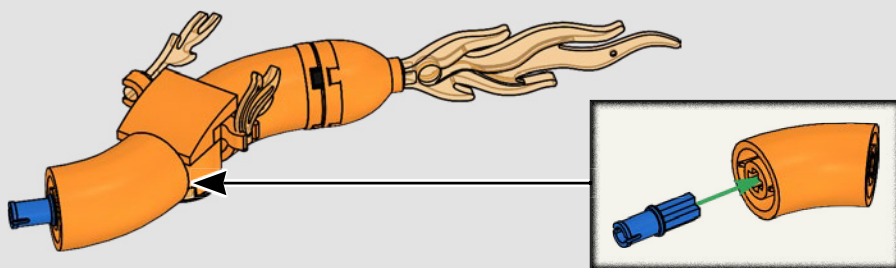

5

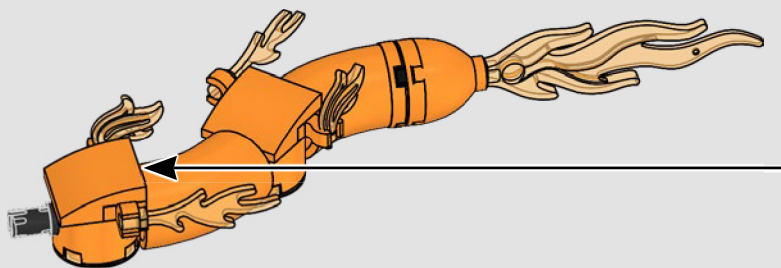
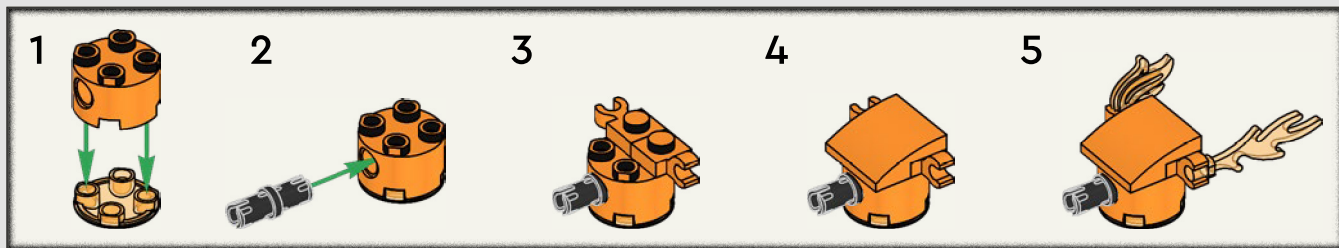

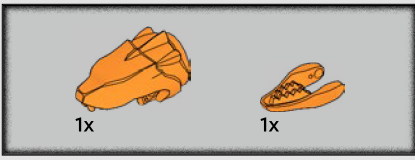

6

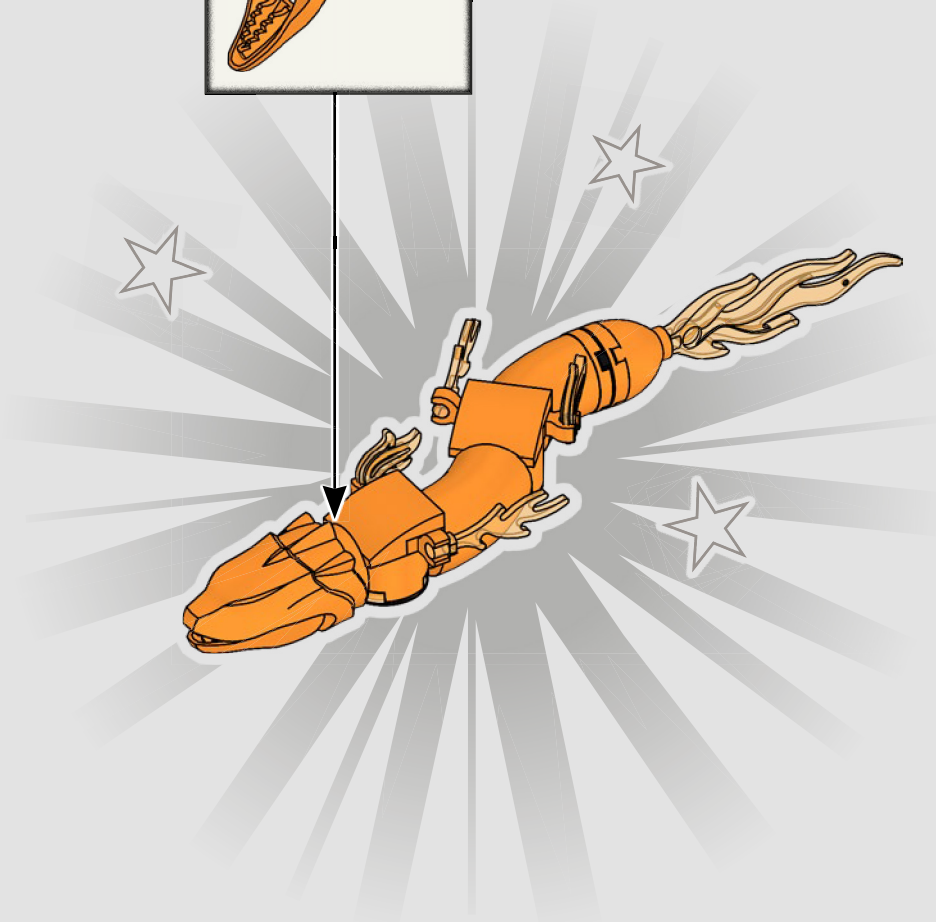
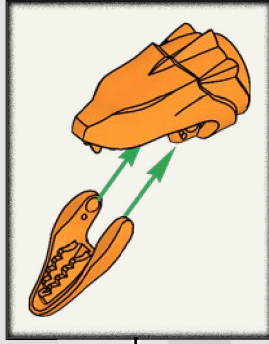



130

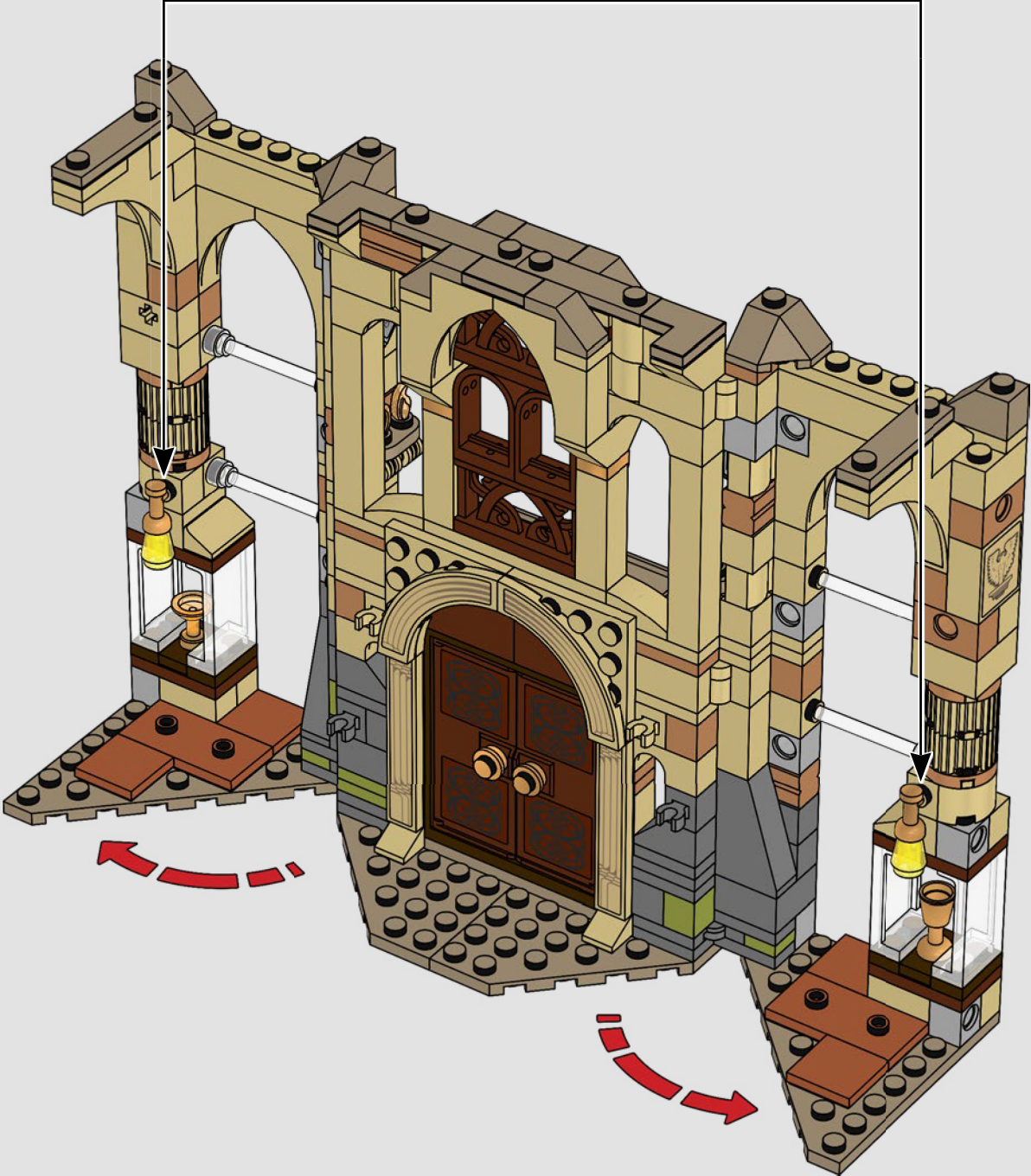
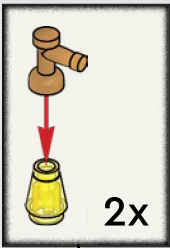

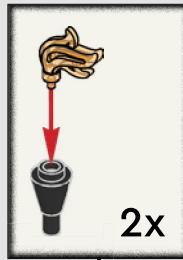
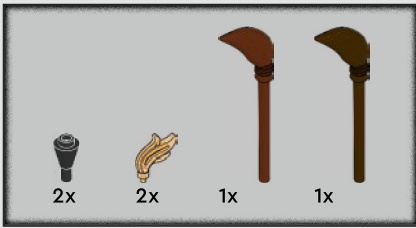

131



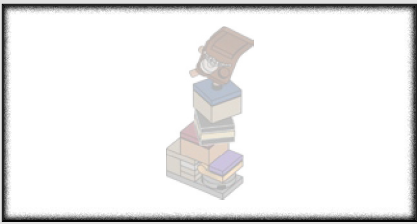

132

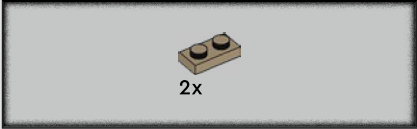
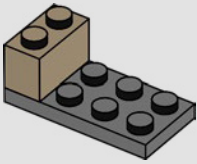

133

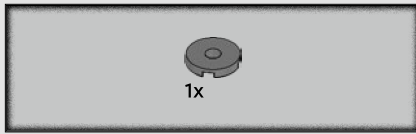
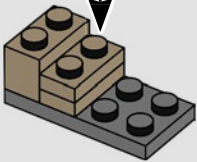
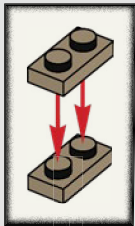

134

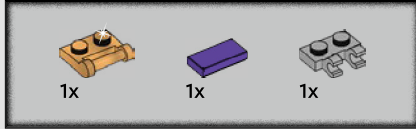
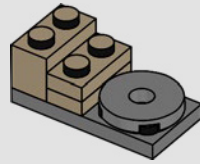

135

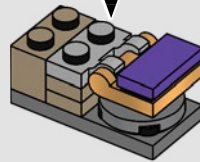
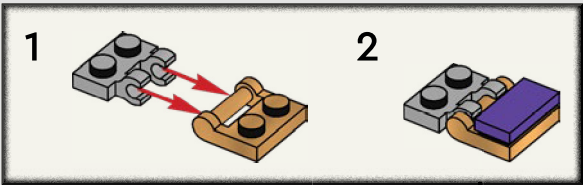

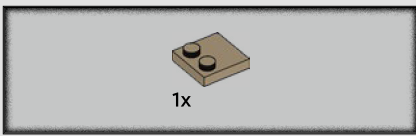

136

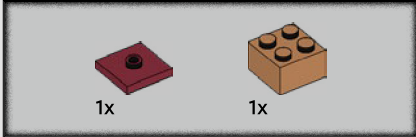
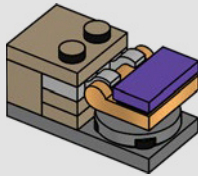

137

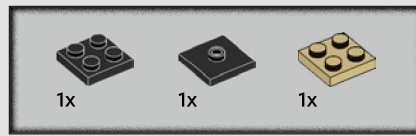
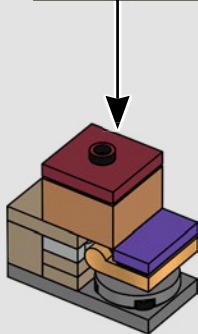
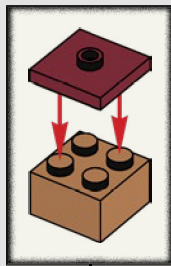

138

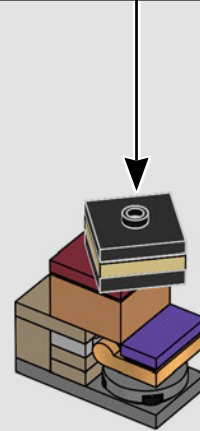
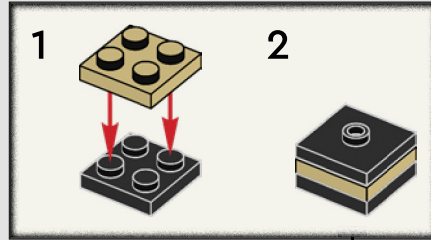

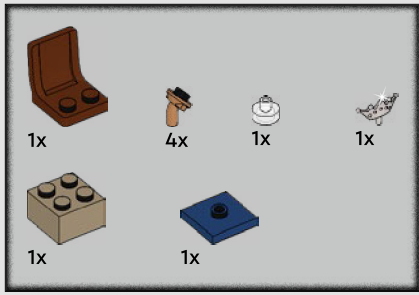

139

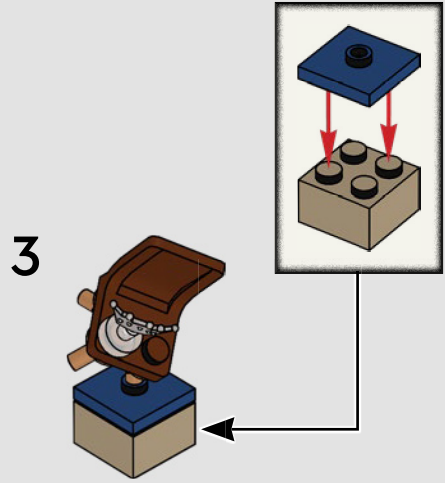
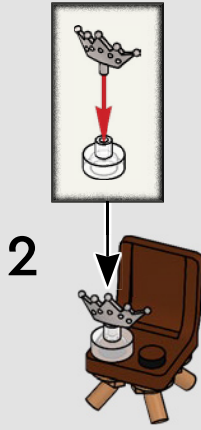
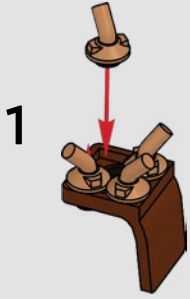

140



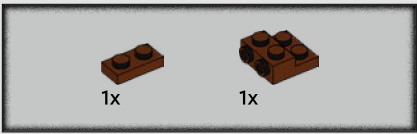

141

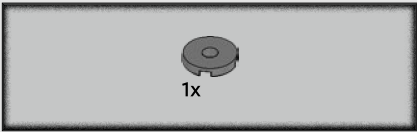
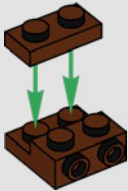

142

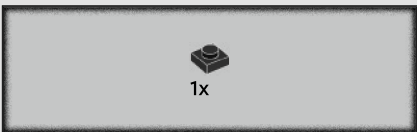
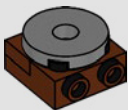

143

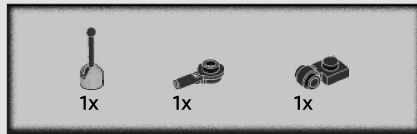
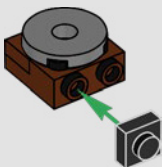

144

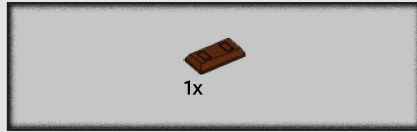
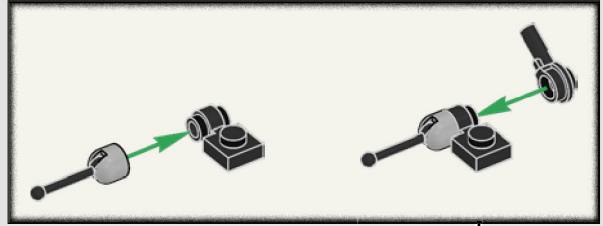

145



146

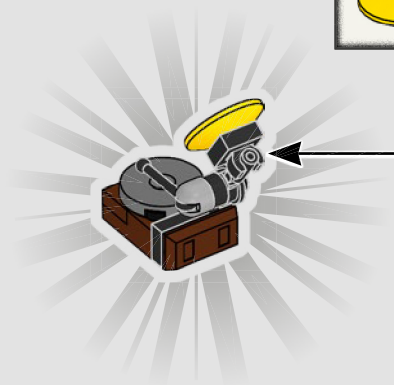
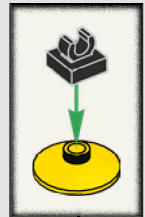



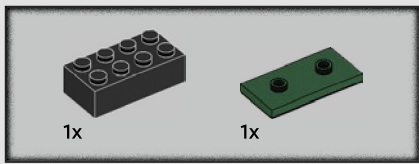

148

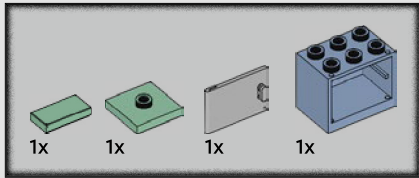
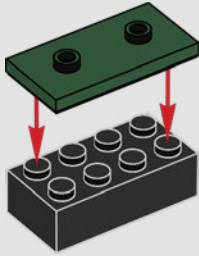

149

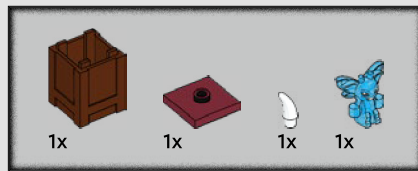
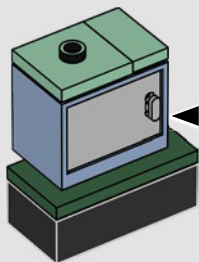
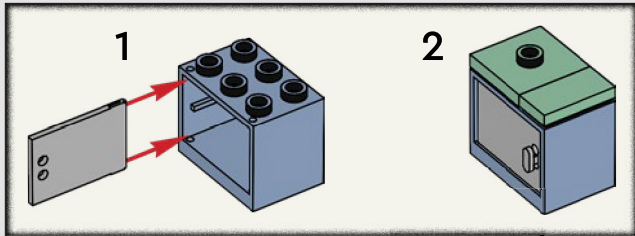

150

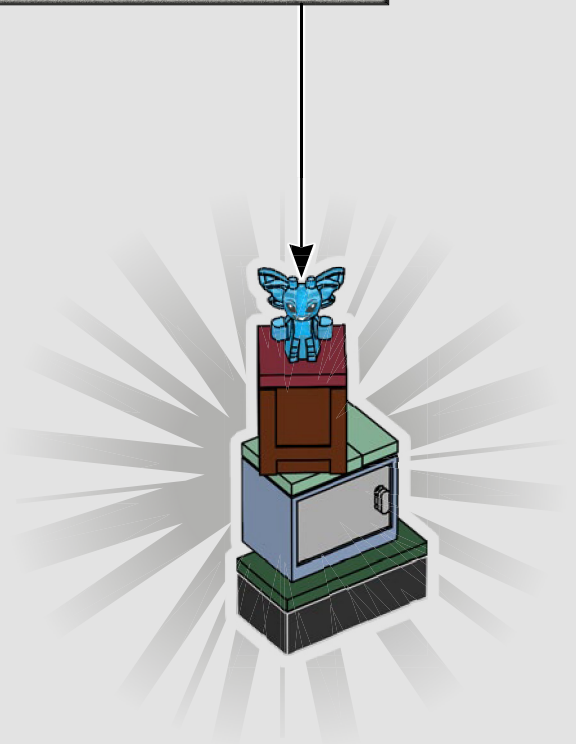
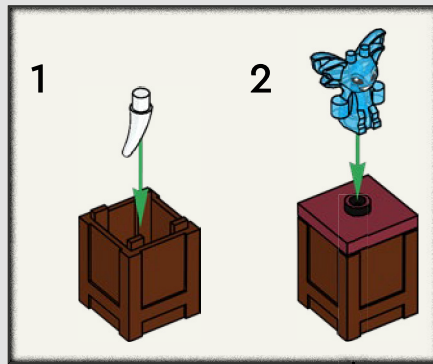



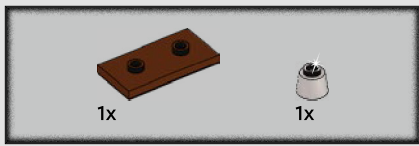

152

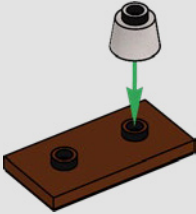

153

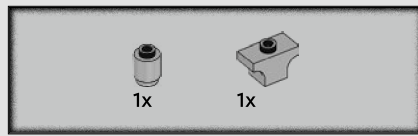
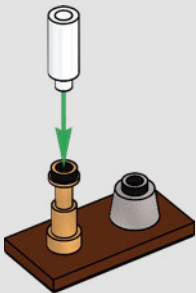

154

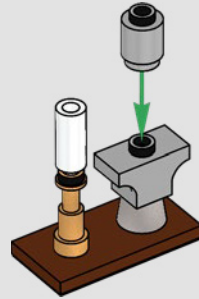

155





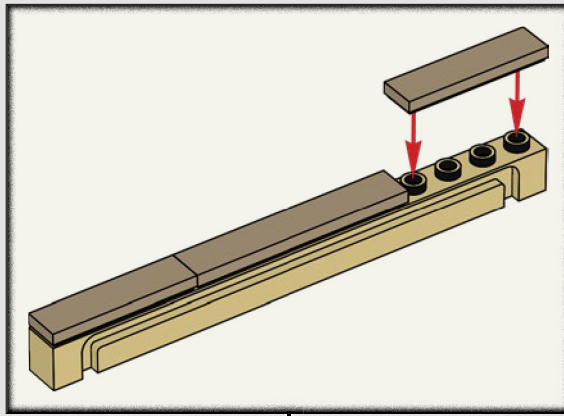
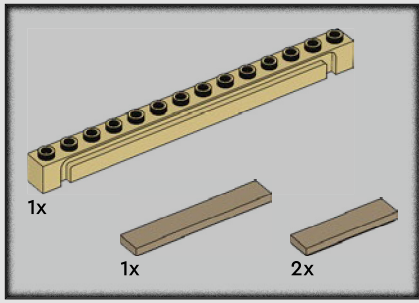

157



158

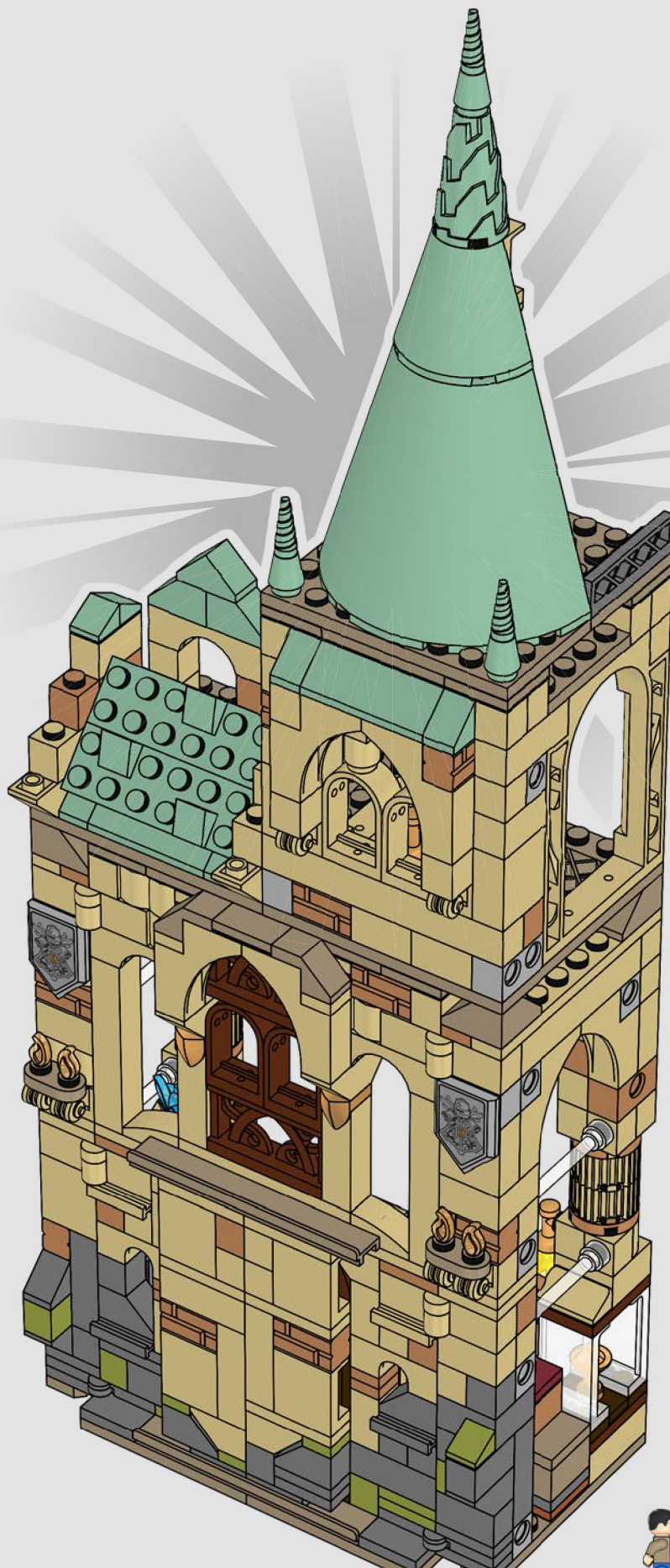

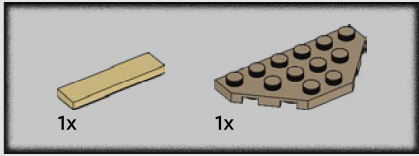
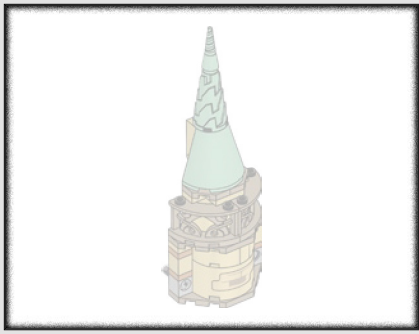

159

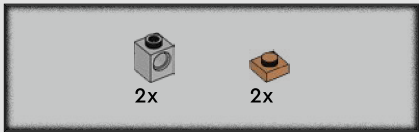
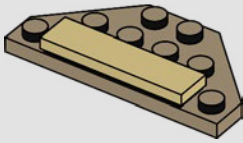

160

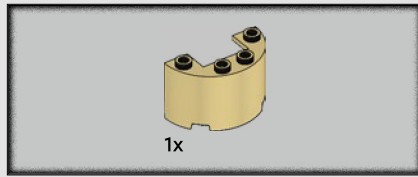
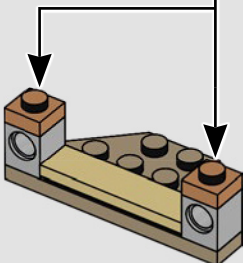
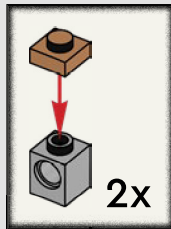

161

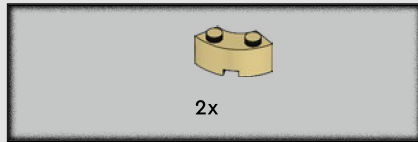
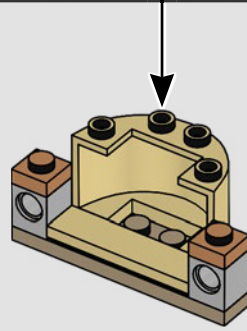
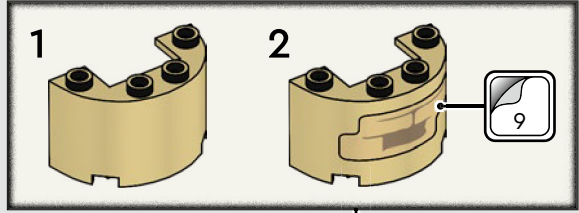

162

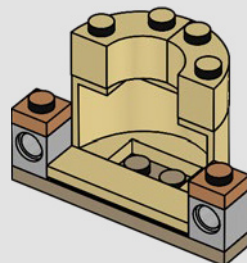

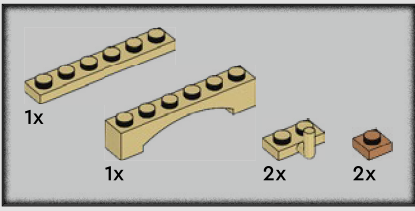

163

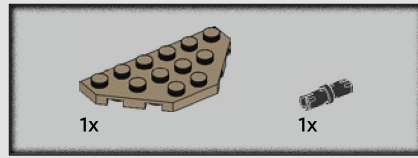
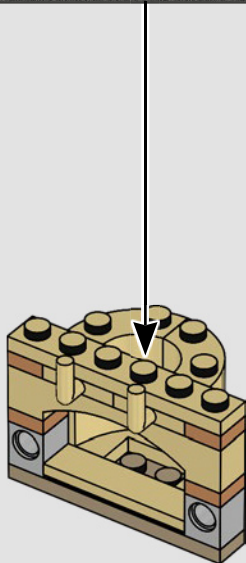
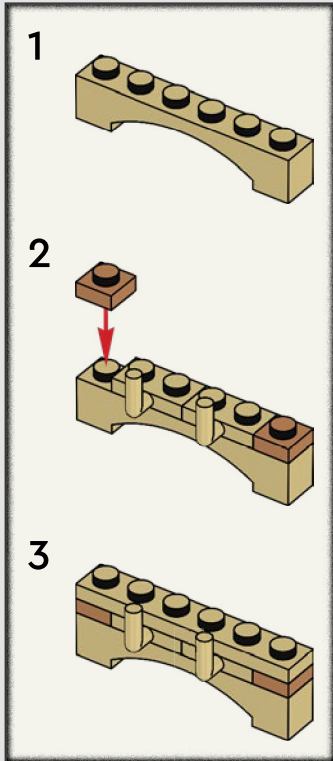

164

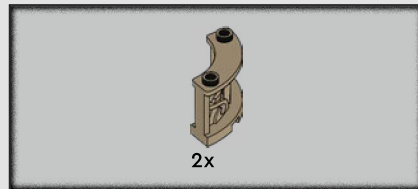
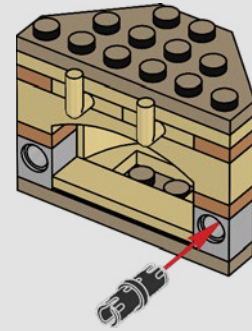

165

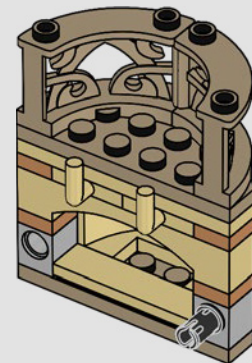

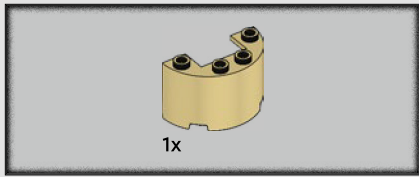

166

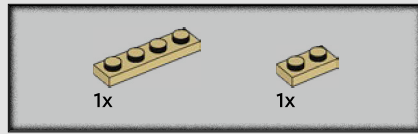
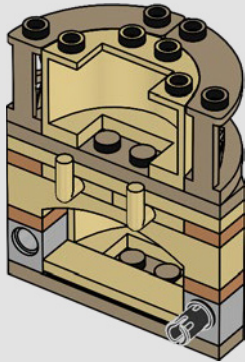

167

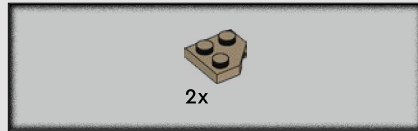
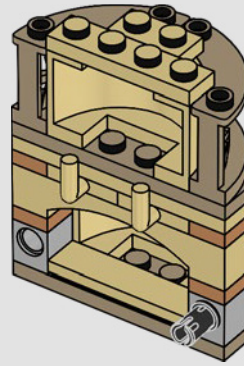

168

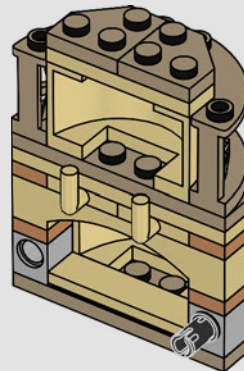

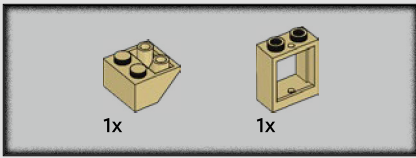

169

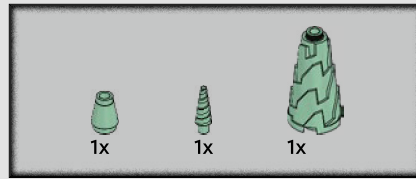
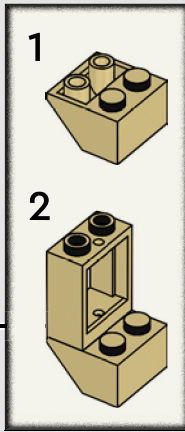
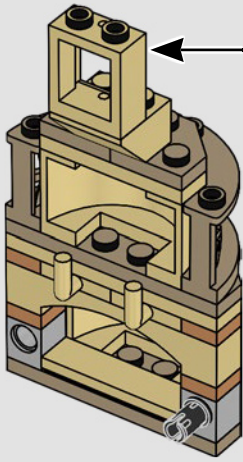

171

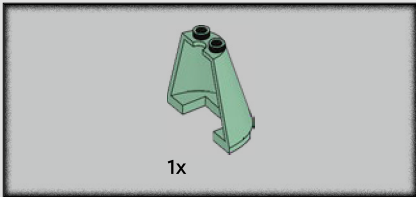
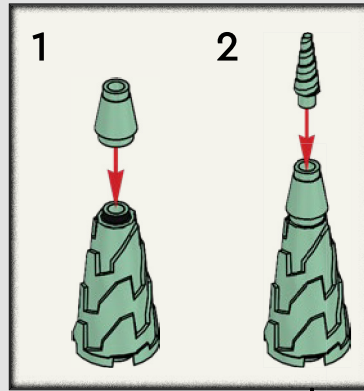

170

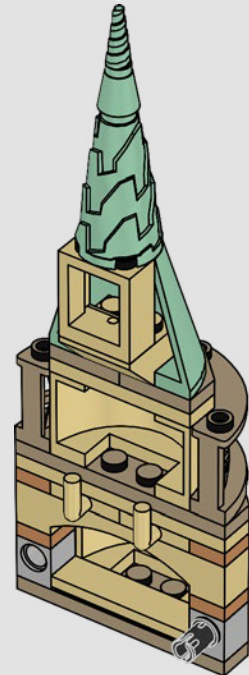
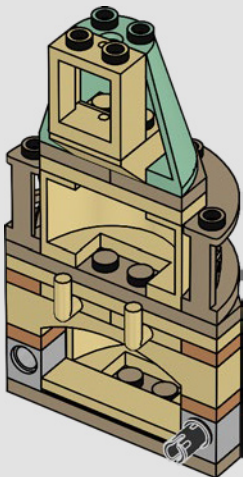

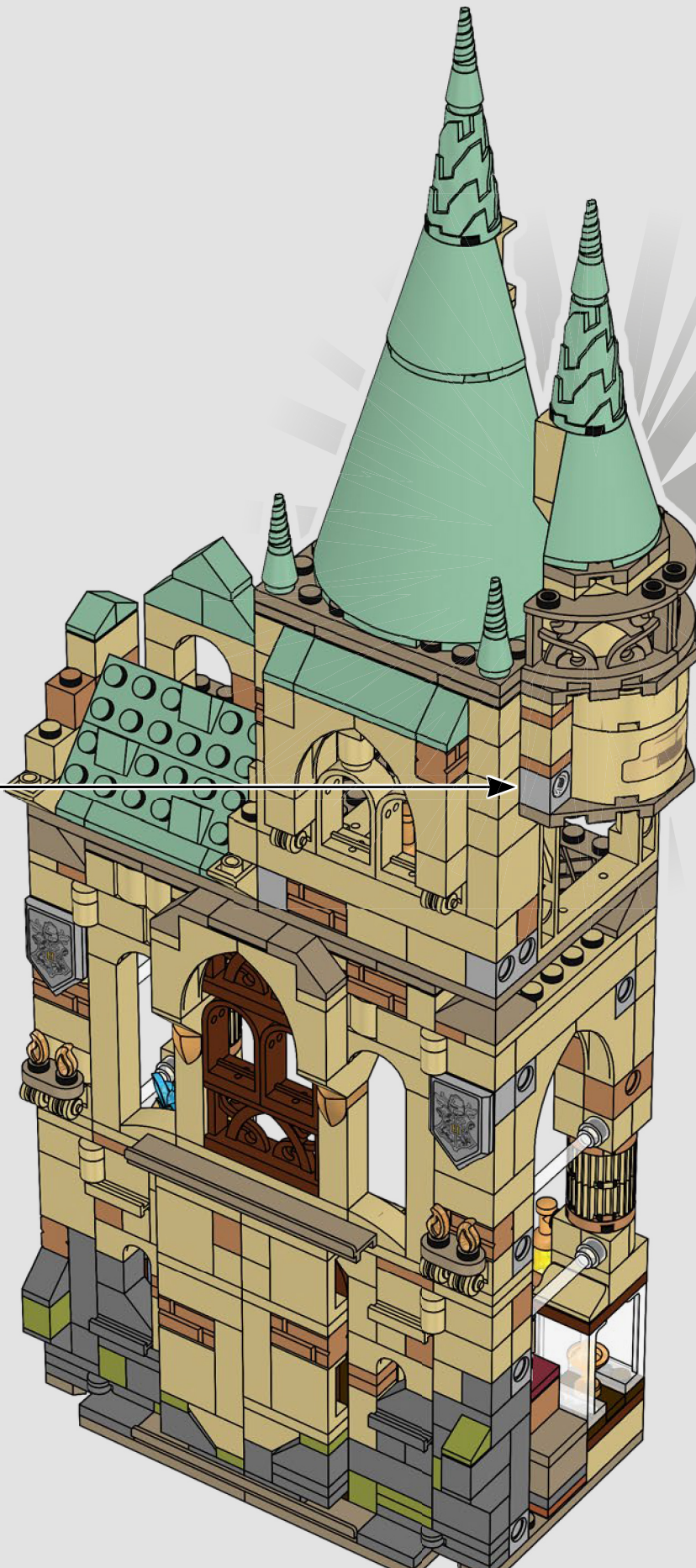

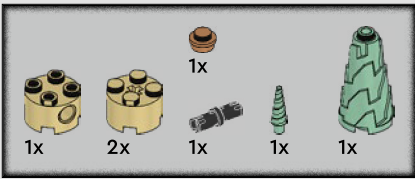

173

1

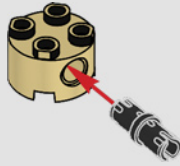

2

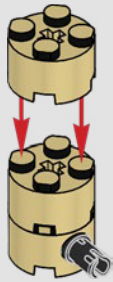

3

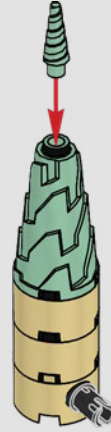

4



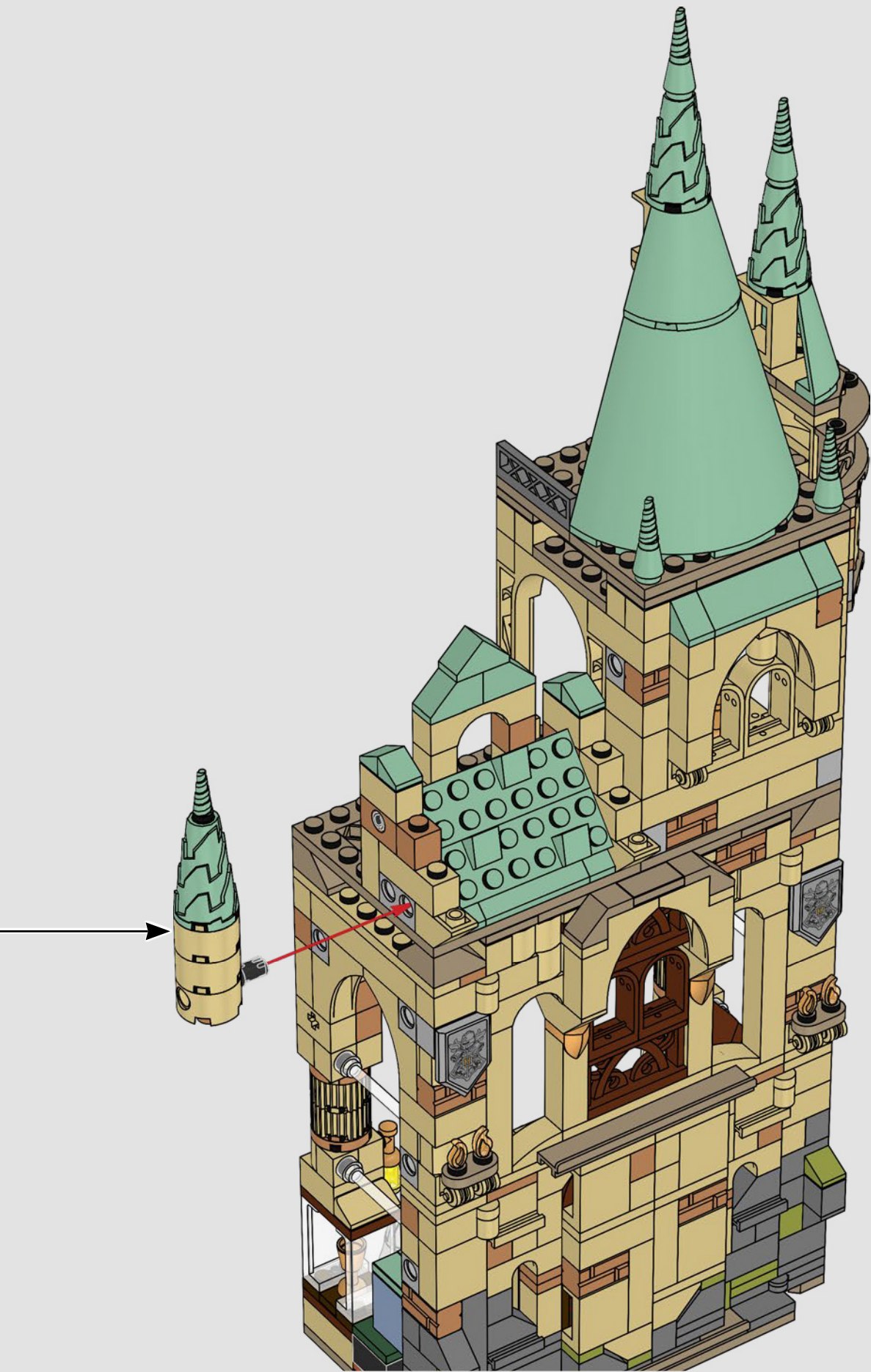







Harry Potter

WIZARDING
WORLD



76420



76413

2x 4117070	6x 4159279	10x 6058093	1x 4159774	3x 4507047	1x 6186867	4x 4211098
12x 4113915	10x 4109995	2x 4618651	1x 4255416	4x 6211814	2x 6321350	2x 6055313
4x 6057517	2x 4623514	2x 6404700	1x 6313660	4x 6166111	2x 4222693	1x 4222693
11x 4579260	2x 6236423	2x 6249554	3x 4124067	2x 6056234	4x 4211063	1x 4222693
4x 6232135	4x 6364438	1x 4550324	2x 4114324	1x 6270031	1x 6270027	4x 4211063
2x 4516055	3x 4113917	2x 4157277	1x 6156462	2x 6231386	1x 6270027	5x 4211135
2x 4112980	3x 6219794	7x 4121921	1x 6349727	2x 6348154	1x 302426	3x 4211088
2x 6055868	1x 4642933	2x 4113233	2x 6035326	2x 4530678	1x 6335388	2x 4211096
2x 6360037	2x 6046922	1x 4114319	2x 6030845	4x 6335228	1x 6356860	2x 4211096
2x 6351413	2x 4121972	2x 6075057	2x 6395743	2x 4496699	1x 4526110	2x 4221745
4x 4650647	1x 6387150	2x 4112982	2x 6430941	2x 4528604	1x 6196548	2x 4543086
2x 4624086	2x 6261357	3x 4550323	2x 6006524	1x 4521914	5x 6279875	2x 4543086
1x 6232037	2x 4160483	2x 4618876	2x 6066524	2x 6228921	1x 4278359	2x 4543086
2x 4125220	4x 6334219	2x 6273864	2x 6141887	6x 6398654	1x 6281993	3x 4211109
5x 4218749	10x 4124455	2x 6371465	2x 6257599	2x 6331865	2x 9339	2x 6309059
8x 6114992	4x 4114077	2x 4114084	2x 4626904	1x 6396392	2x 6192309	1x 6433889
4x 6063943	2x 4118866	7x 4162465	2x 6175927	1x 6270106	2x 6147050	1x 4211104
12x 4159196	1x 4114084	2x 6348203		1x 6234807	1x 302226	2x 4211133
	7x 4162465			1x 6420417	1x 4565323	2x 4219725
				2x 6057414	1x 6413068	2x 6416526
				2x 6232029	1x 300126	1x 4211065
				1x 6047220		

4x
6357747

2x
6167741

1x
6323033

4x
6314353

1x
6371449

2x
6171727

4x
6186423

2x
6288614

2x
6347295

2x
6352223

1x
6030521

2x
6120639

1x
6147052

1x
6368880

2x
6067913

1x
6430957

2x
6433933

1x
6430952

4x
6400315

1x
6167641

10x
6057986

10x
6215606

4x
6167643

9x
4656783

5x
6192920

2x
6218360

1x
6058085

4x
6209691

1x
4505990

2x
4523159

3x
6146054

2x
6083975

1x
4538126

1x
4585493

1x
4142865

4x
6058221

2x
6404033

2x
6270032

1x
6430932

1x
6430932

1x
6315678

1x
6268855

2x
4542131

1x
4211150

1x
6261744

1x
6266075

2x
6426733

1x
4211202

1x
4520638

1x
4211206

1x
6146301

2x
6430945

4x
4211189

2x
6431676

1x
6307618

1x
4221590

1x
4169960

2x
6337597

1x
6309172

1x
6192171

1x
6420343

1x
6265371

1x
6420348

5x
6223215

4x
6134280

7x
4652205

1x
6376005

3x
6351403

6x
6083976

1x
4616578

1x
6186826

2x
6351382

2x
6351392

2x
6194726

1x
6351385

1x
4221775

1x
4211412

18x
4211535

3x
4211807

1x
6433987

4x
4211541

2x
6248492

2x
4211398

1x
6066097

2x
6015344

1x
4211469

1x
4211470

1x
6429026

1x
6132390

1x
6337268

1x
6420422

2x
6245254

1x
6433935

1x
6426732

1x
6317181

1x
6037507

1x
6404592

1x
6413538

1x
6433763

1x
6389696

3x
4206482

1x
9341

1x
4613192

2x
4613761

6x
6058245

4x
6058242

1x
6002841

2x
6016483

1x
6383324



[LEGO.com/service](https://www.LEGO.com/service)

YOU COULD **WIN**

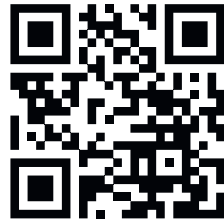

Scan this QR code or go to **LEGO.COM/PRODUCTFEEDBACK** and give us your short feedback about this LEGO® set for a chance to win a cool LEGO prize.

Terms and Conditions apply*

DE: Du könntest GEWINNEN. Es gelten die Teilnahmebedingungen* **FR: Tu pourrais GAGNER.** Des conditions s'appliquent* **IT: Potresti VINCERE tu.** Termini e condizioni sono applicabili* **ES: Puedes GANAR.** Aplican términos y condiciones* **PT: Poderá GANHAR.** Aplicam-se termos e condições* **JA: プレゼント付き! 利用規約が適用されます*** **ZH: 轻松获奖. 条款和条件适用*** **KO: 상품의 주인이 되어보세요. 소정의 약관이 적용됩니다*** **RU: Вы можете ВЫИГРАТЬ.** Действуют положения и условия* **PL: Szansa na WYGRANĄ.** Obowiązują warunki korzystania* **CS: Máte šanci VYHRÁT.** Platí všeobecné smluvní podmínky* **SK: Máte šancu VYHRAŤ.** Platia všeobecné zmluvné podmienky* **HU: TE IS NYERHETSZ.** Felhasználási feltételek érvényesek* **RO: Ai putea CÂȘTIGA.** Se aplică termenii și condiții* **BG: Можете да СПЕЧЕЛИТЕ.** Има определени правила и условия* **LV: Tu vari LAIMĒT.** Ir spēkā noteikumi un nosacījumi.* **ET: Sul on võimalus VÕITA.** Kehtivad tingimused* **LT: Jūs galite LAIMĖTI.** Taikomos sąlygos*

*[LEGO.com/productfeedback-terms](https://www.lego.com/productfeedback-terms)

LEGO and the LEGO logo are trademarks of the LEGO Group. ©2023 The LEGO Group.

WIZARDING WORLD and all related trademarks, characters, names, and indicia are © & ™ Warner Bros. Entertainment Inc. Publishing Rights © JKR. (s23)