



NINJAGO

71759





We're switching from plastic to paper-based packaging. That's why you might find a mix of paper and plastic in our boxes!

Wir stellen von Kunststoffverpackungen auf Verpackungen auf Papierbasis um. Möglicherweise findest du deshalb sowohl Papier als auch Kunststoff in unseren Boxen!

Nous abandonnons progressivement les emballages en plastique au profit d'emballages à base de papier. Il est donc possible que vous trouviez à la fois du papier et du plastique dans nos boîtes !

Stiamo passando dagli imballaggi di plastica a quelli basati su carta. Ecco perché potrete trovare un mix di carta e di plastica nelle nostre confezioni!

Estamos sustituyendo las bolsas de plástico por bolsas con base de papel. ¡Por eso, puede que encuentres una mezcla de papel y de plástico en nuestras cajas!

Estamos a substituir as nossas embalagens de plástico por embalagens à base de papel. Por isso poderá encontrar um misto de papel e plástico nas nossas caixas!

Átállunk a műanyagról a papír alapú csomagolásra. Ezért előfordulhat, hogy a dobozainkban papír és műanyag zacskót egyaránt találasz!

Mēs pārejam no plastmasas iepakojuma uz iepakojumu, kurā izmantots papīrs. Tāpēc mūsu kārbās var būt gan papīra, gan plastmasas daļas.

Trecem de la ambalaje din material plastic la ambalaje pe bază de hârtie. Iată de ce s-ar putea să găsești un amestec de hârtie și material plastic în cutiile noastre!

我们正在从塑料包装向纸基包装过渡。这就是为什么你可能会发现我们的包装盒中同时出现塑料和纸质材料！

[LEGO.com/sustainable-packaging](https://www.lego.com/sustainable-packaging)



Check for compatibility
Kompatibilität prüfen
Vérifier la compatibilité
Controlla la compatibilità
Comprueba tu compatibilidad
Verificar a compatibilidade
Ellenőrizd a kompatibilitást
Pārbaudīt saderību
Verificarea compatibilității
检查兼容性

LEGO.com/devicecheck

乐高®拼搭指引



LEGO® Building Instructions



Apple and the Apple logo are trademarks of Apple Inc.
Google Play and the Google Play logo are trademarks of Google LLC.
Tencent and the Tencent logo are trademarks of Tencent Inc.



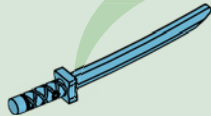

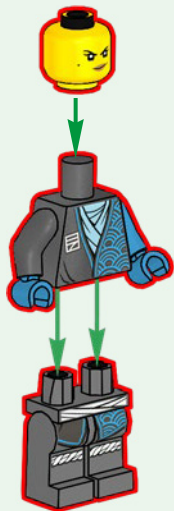

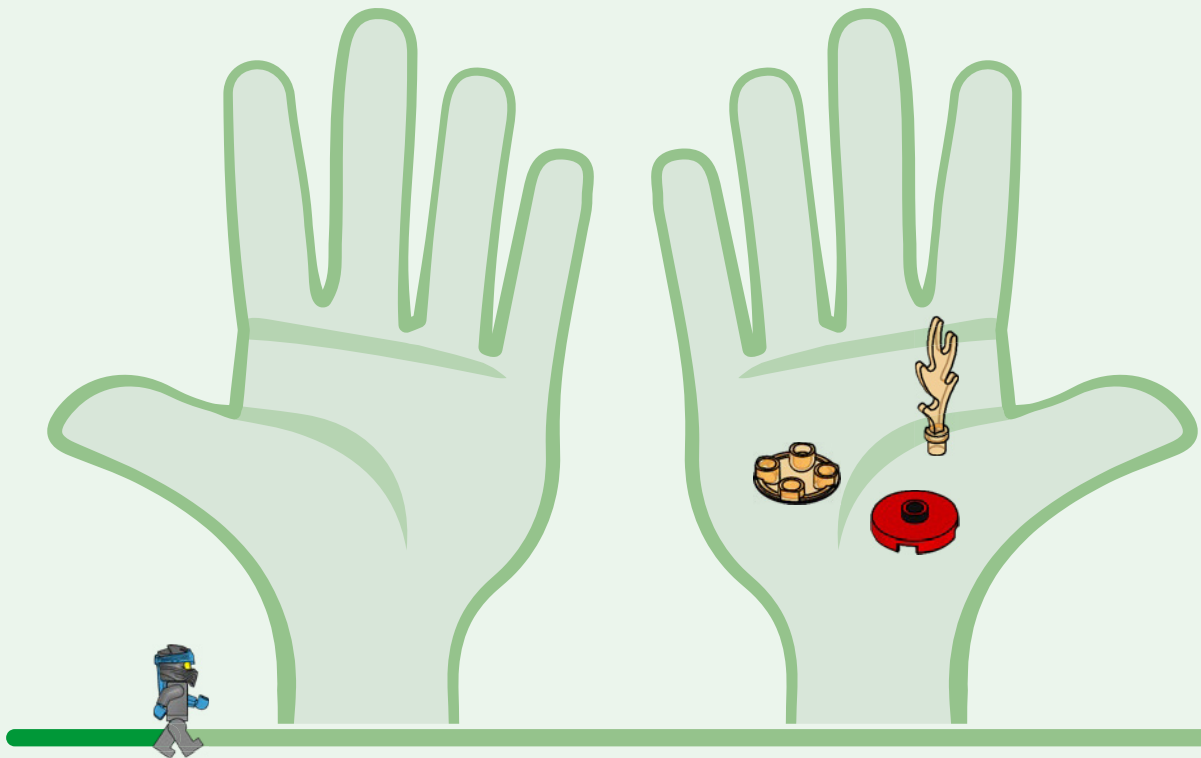



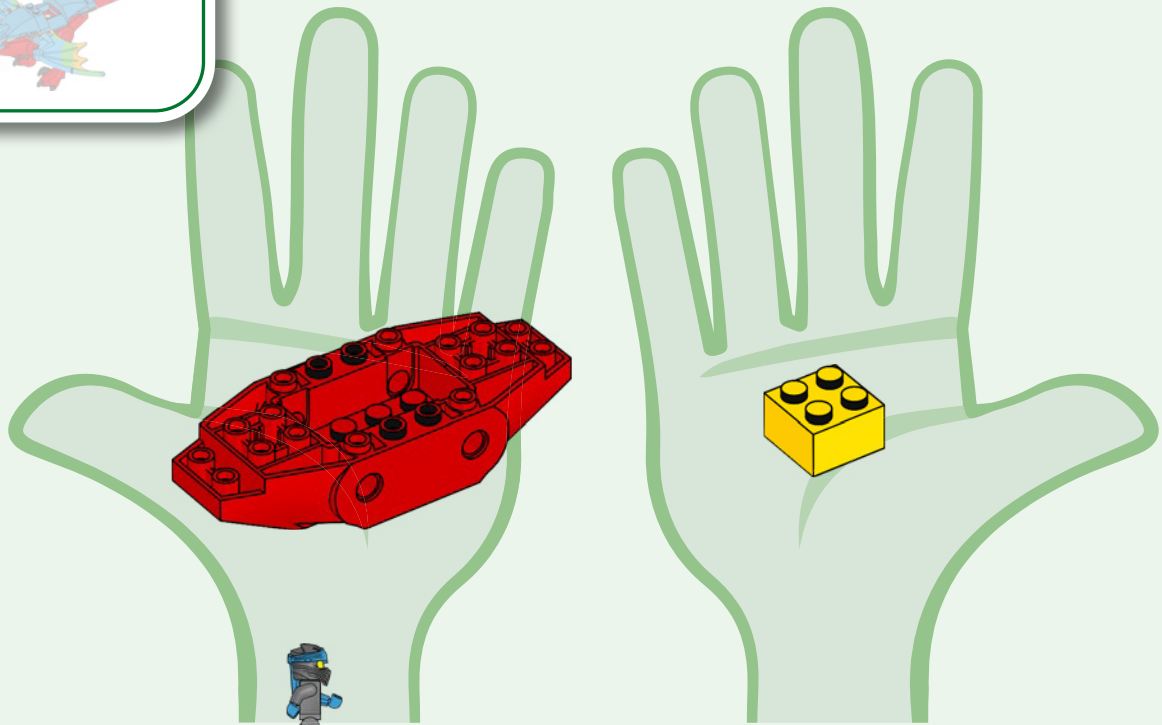

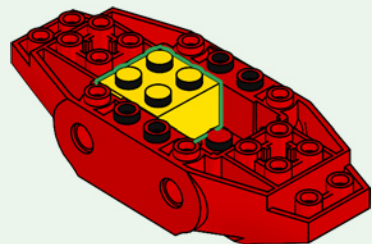
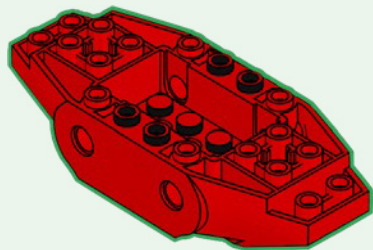

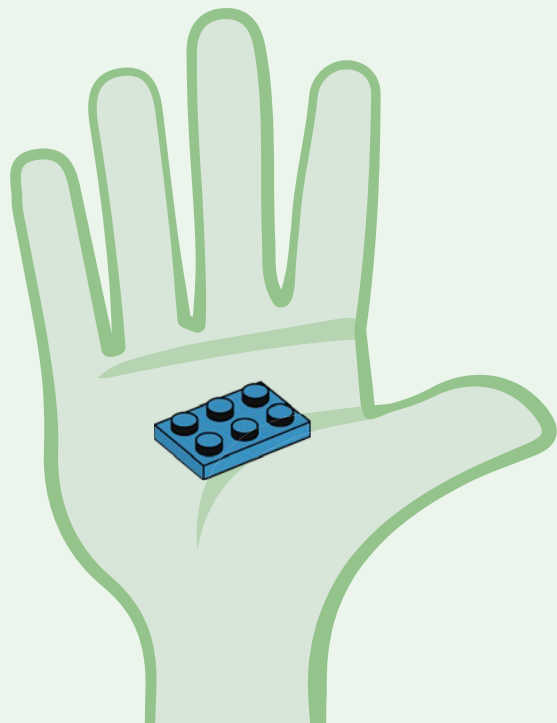
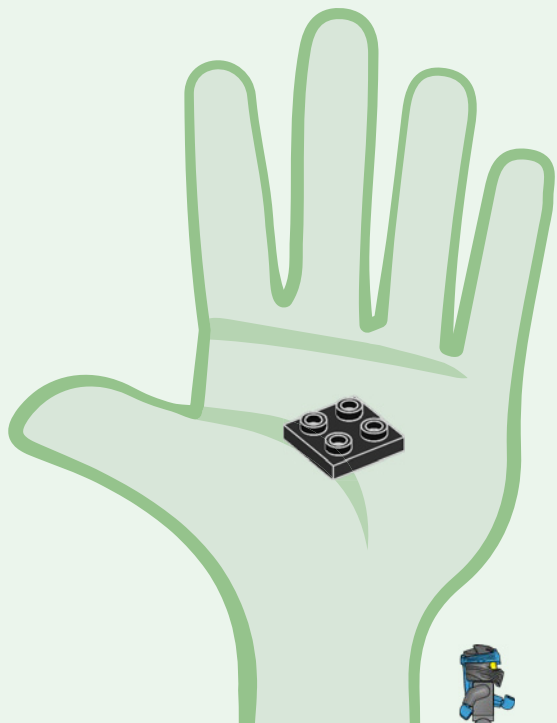

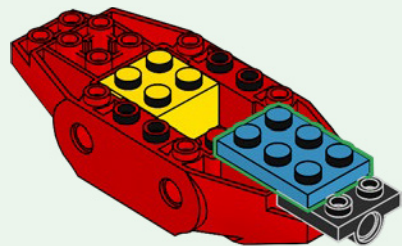
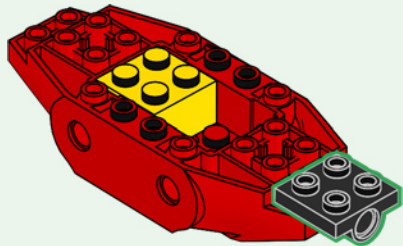

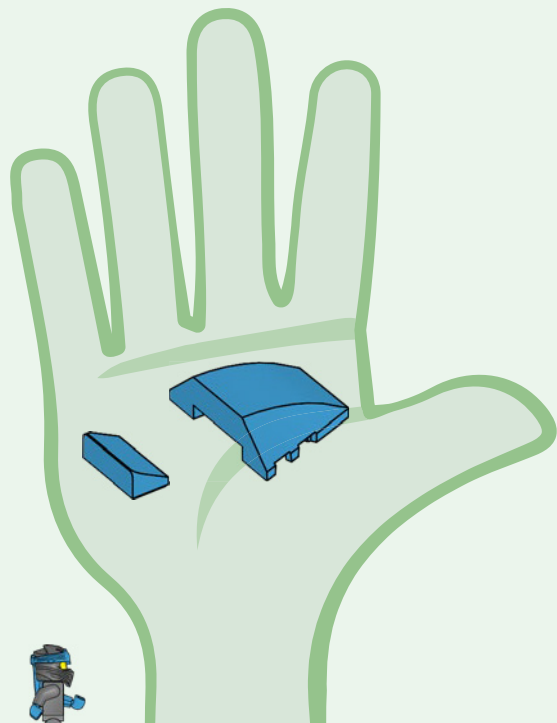
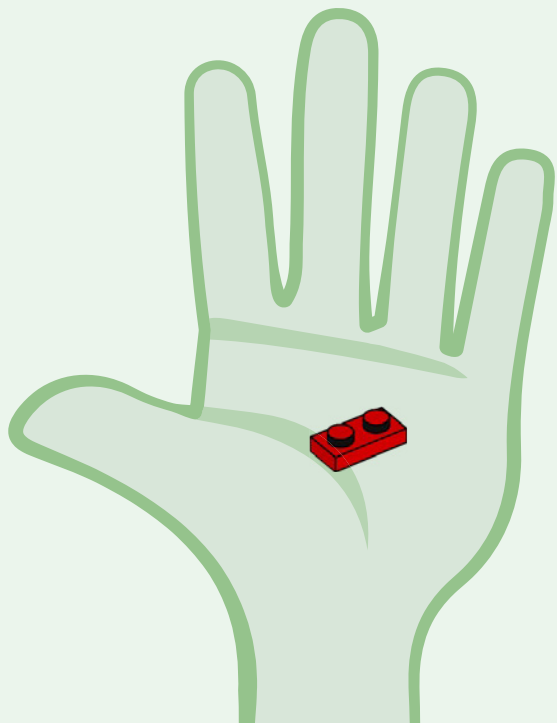

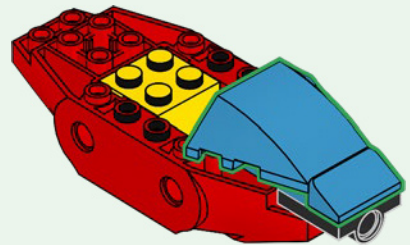
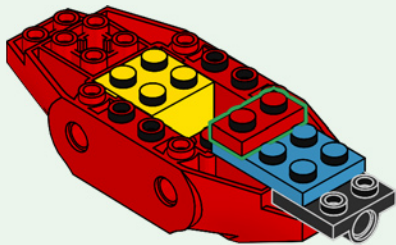

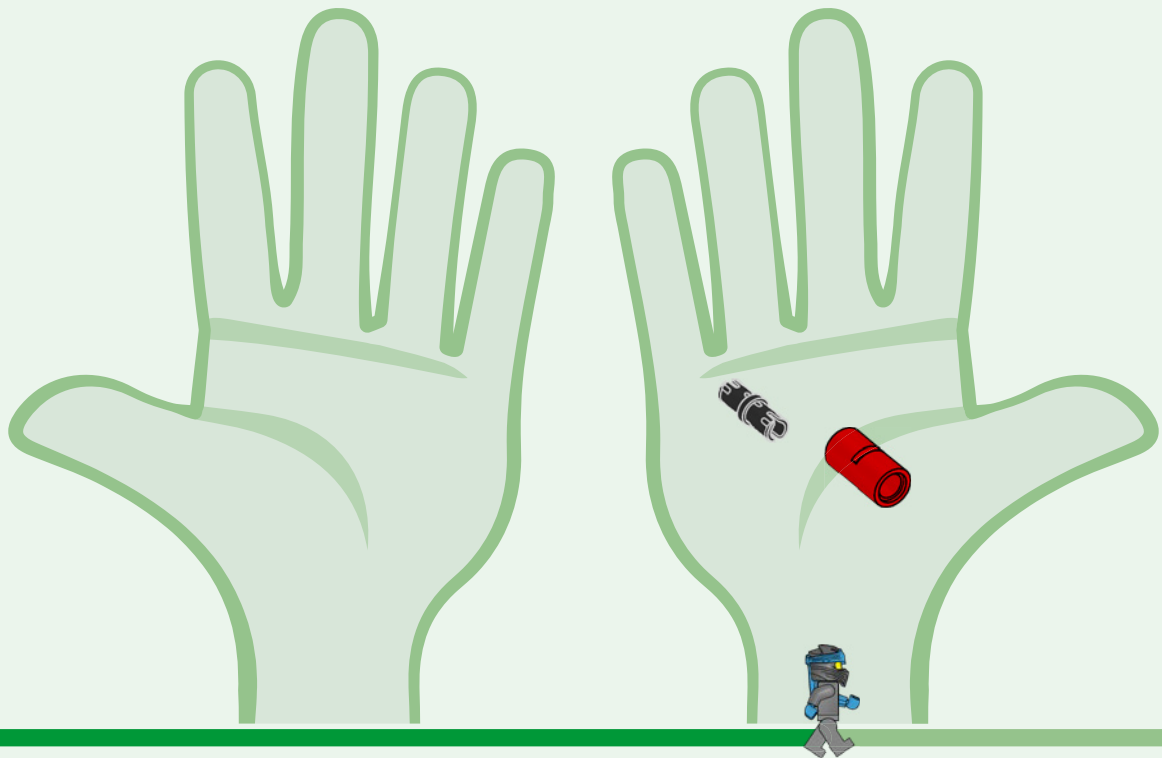

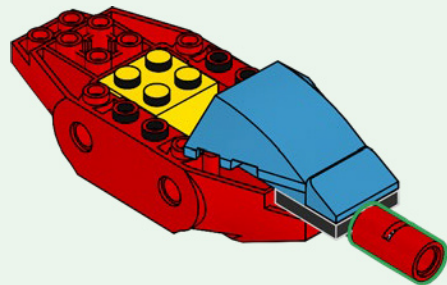
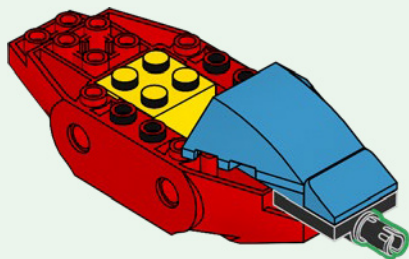

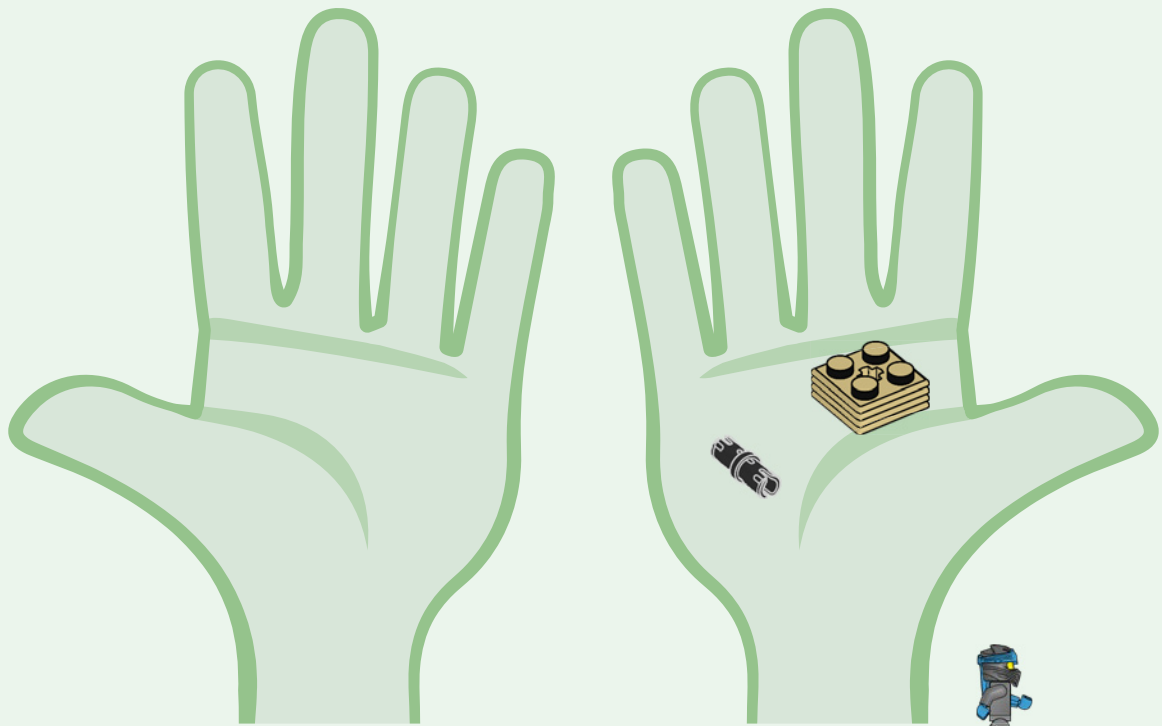

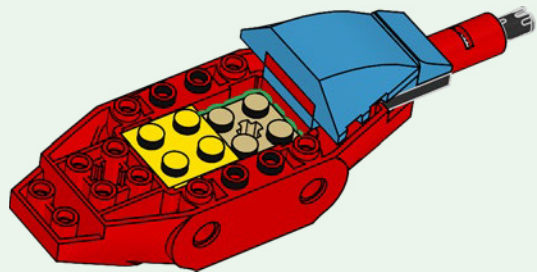
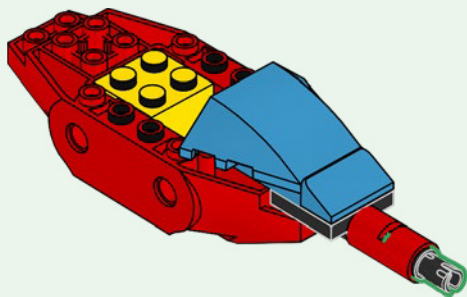

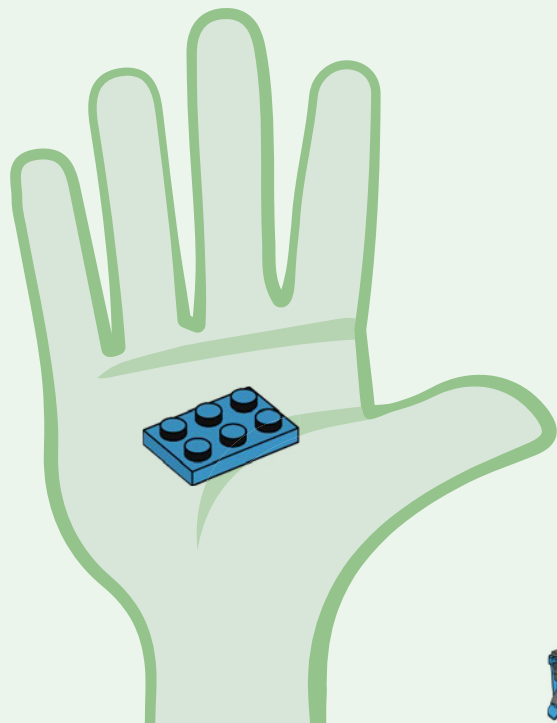
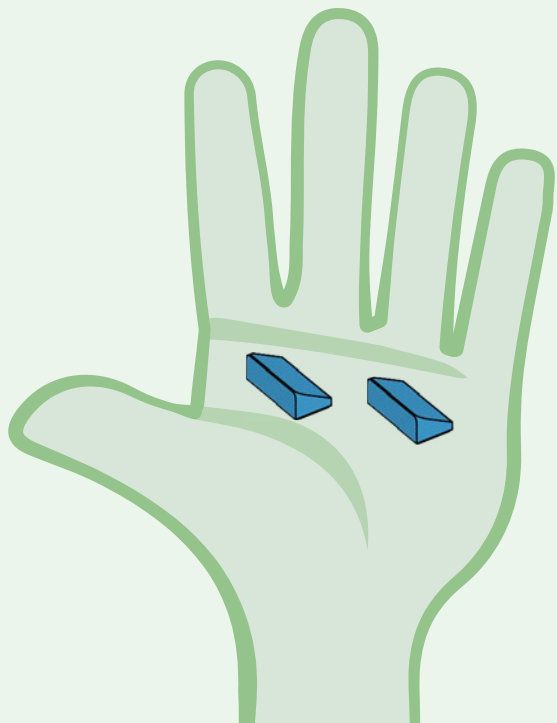

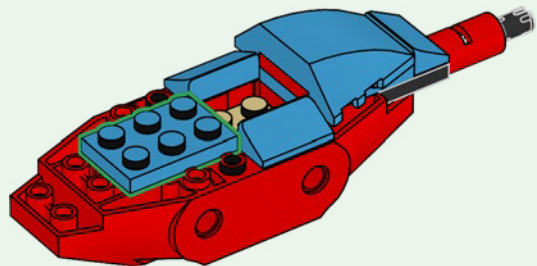
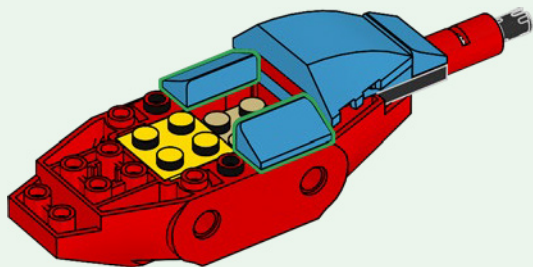

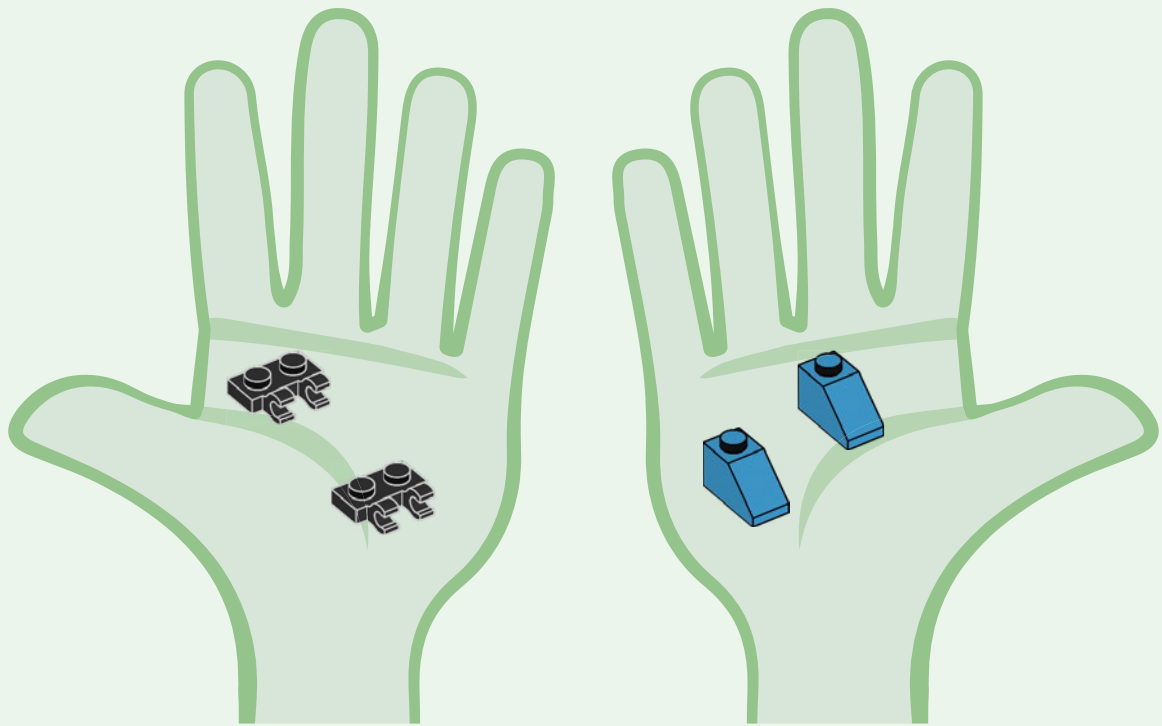

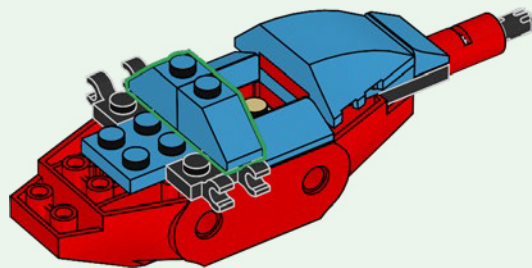
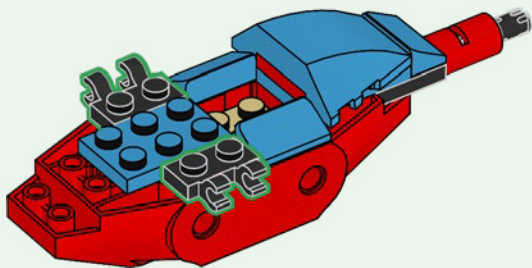

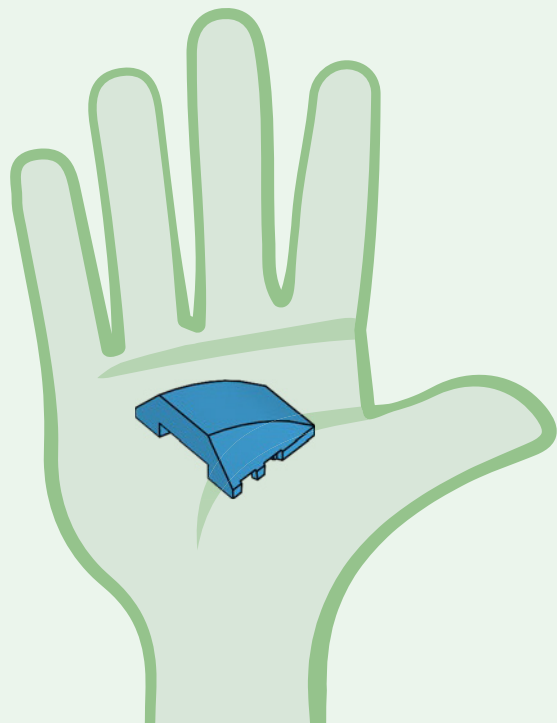
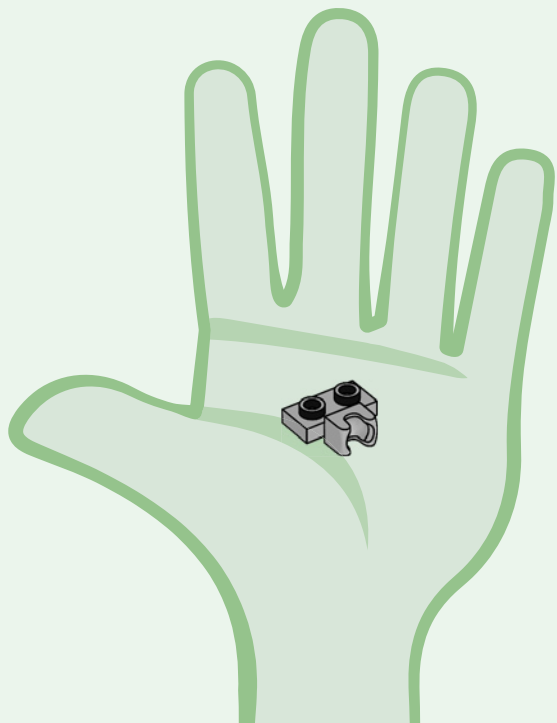

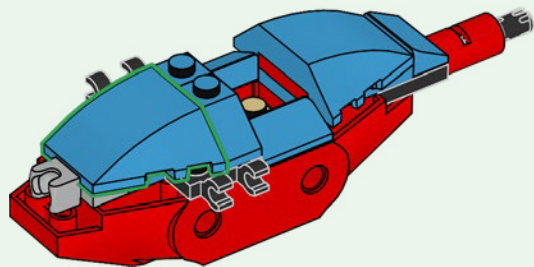
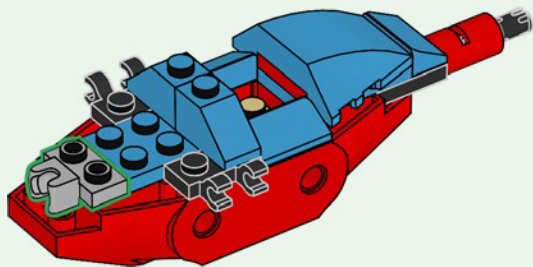

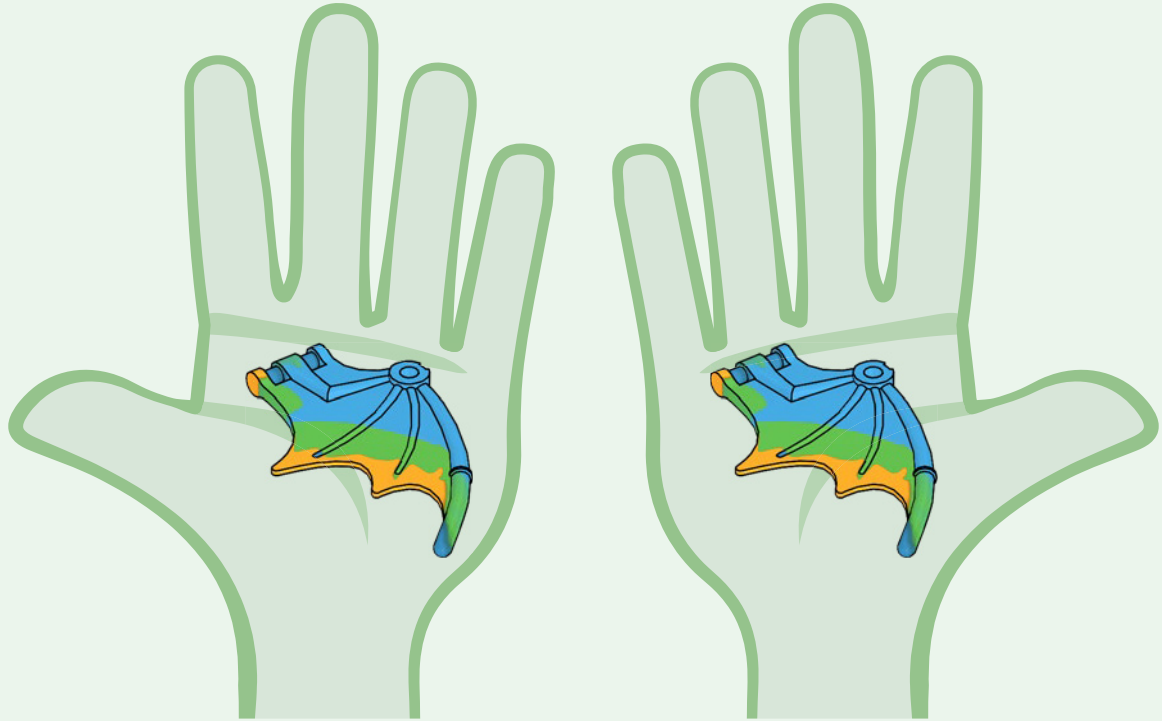

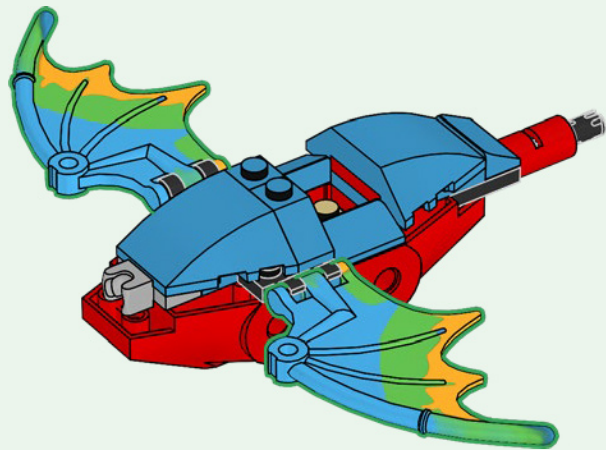

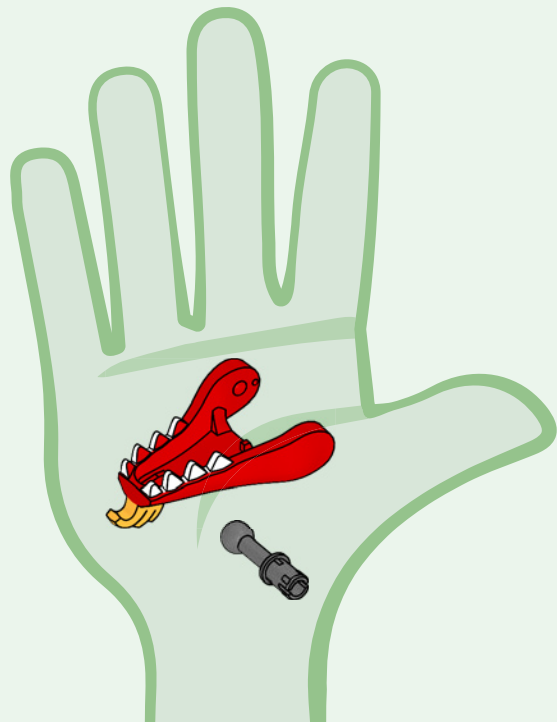
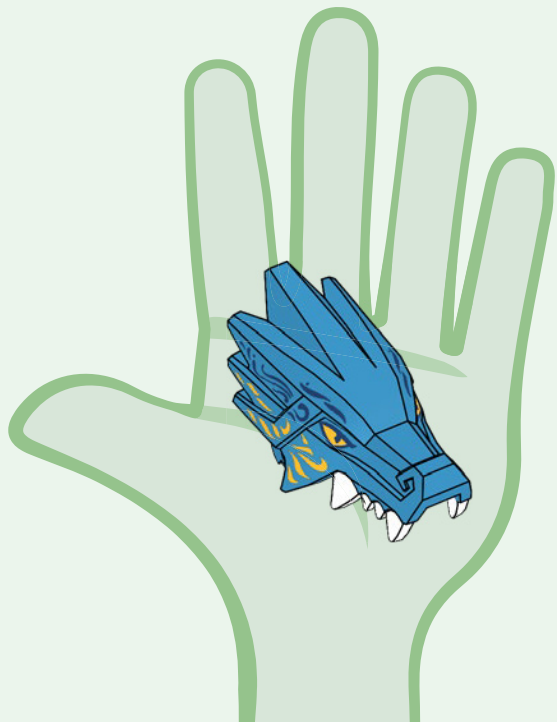

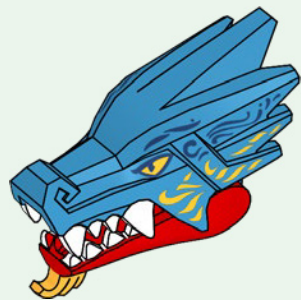
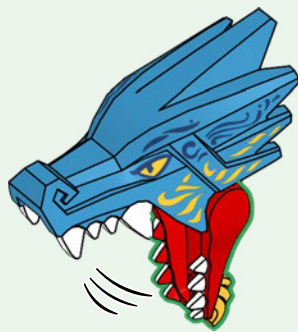
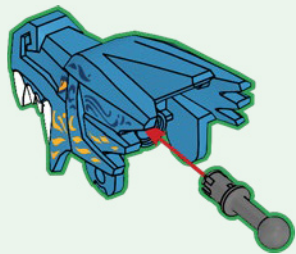

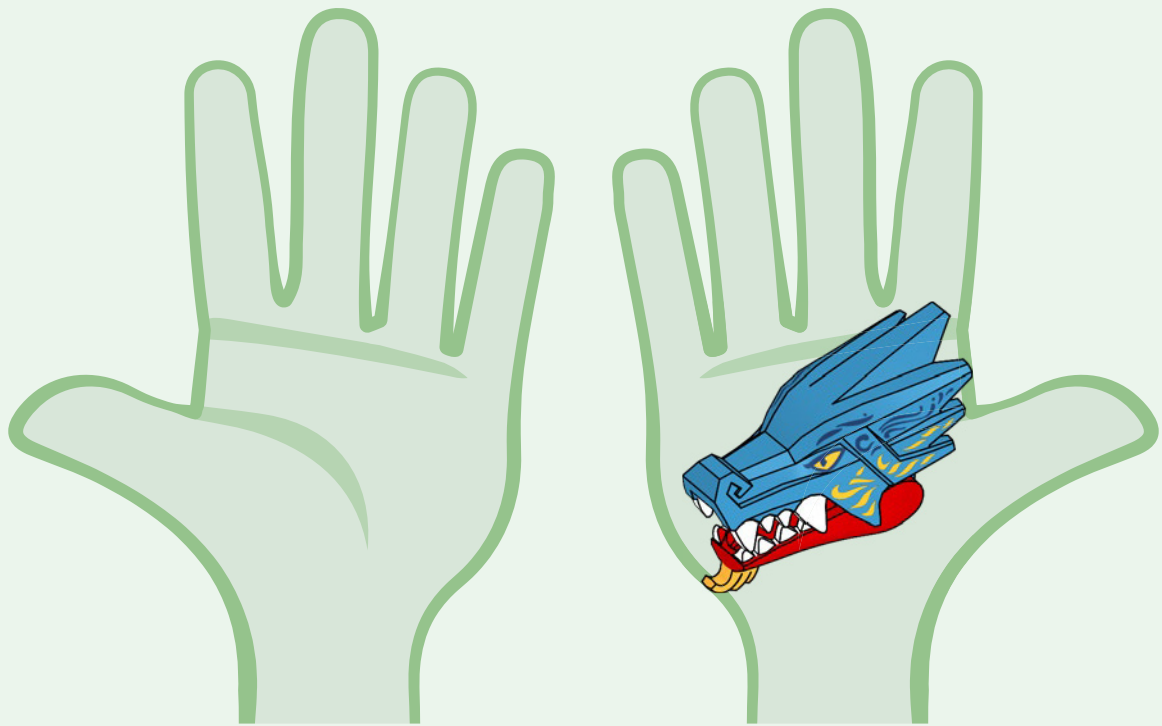

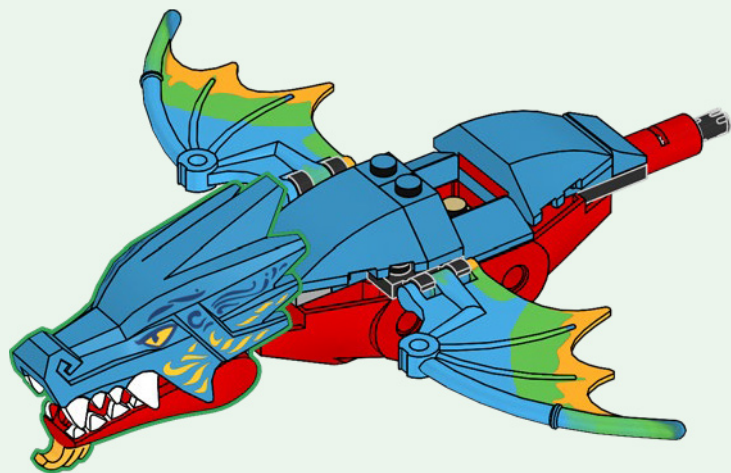

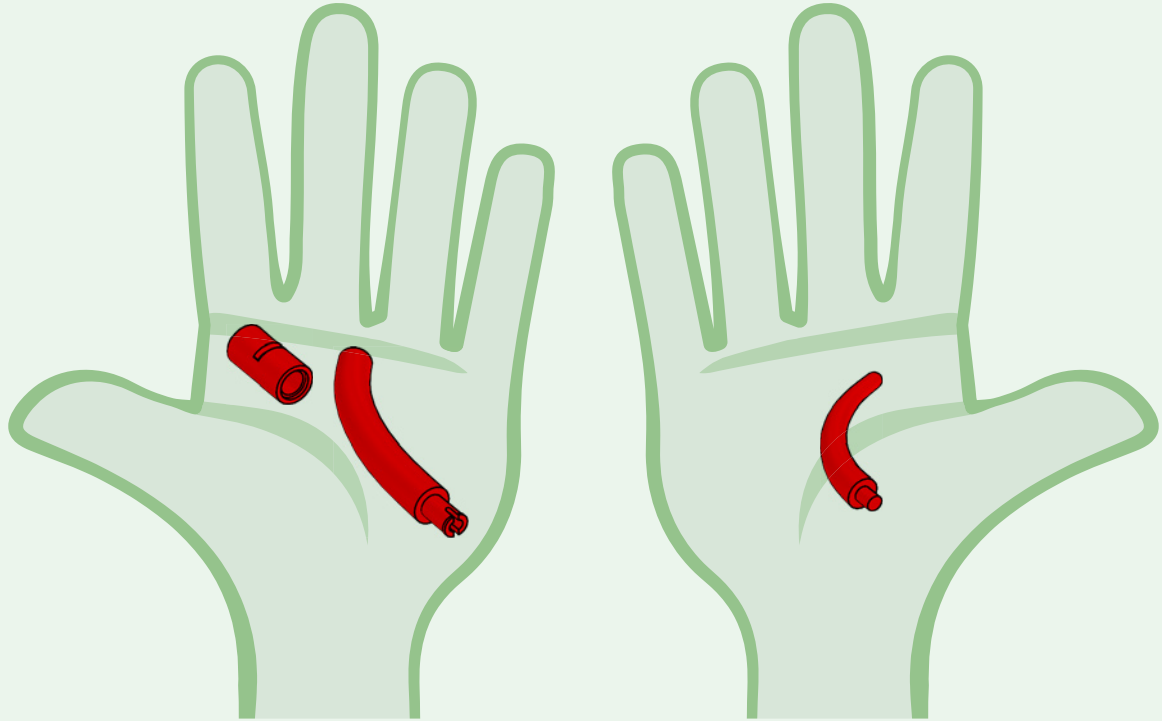

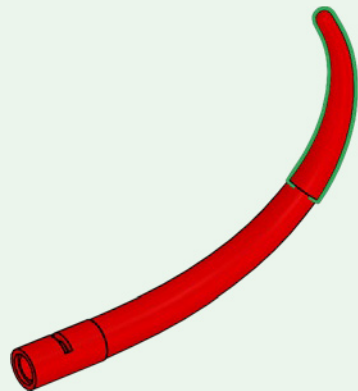

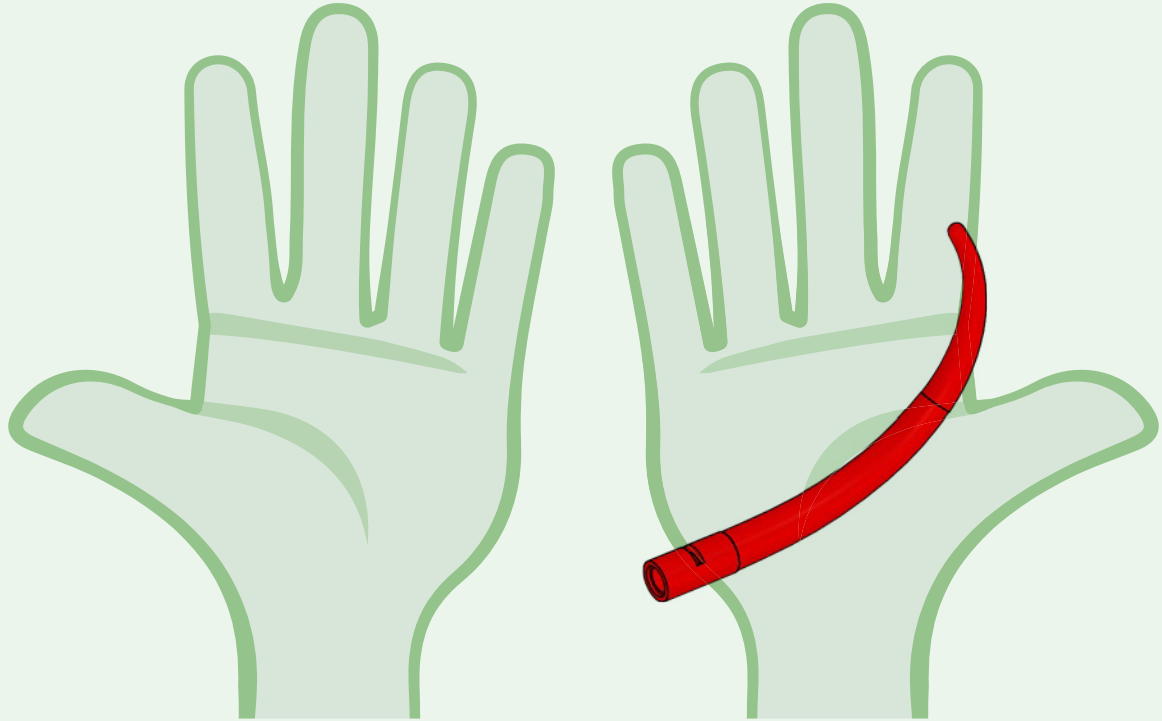

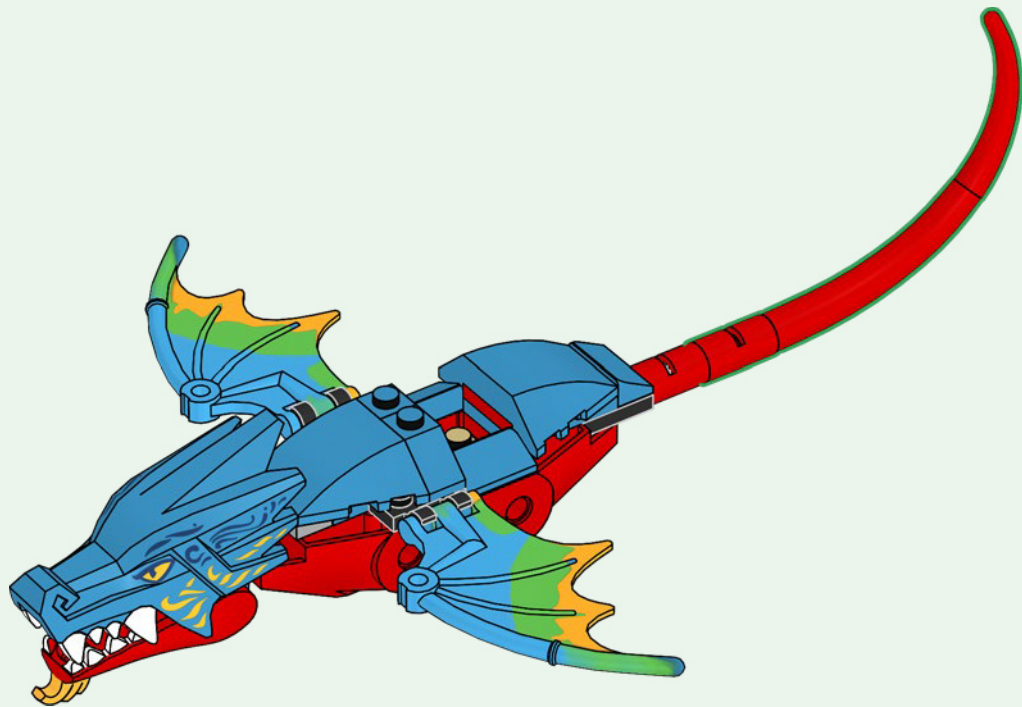

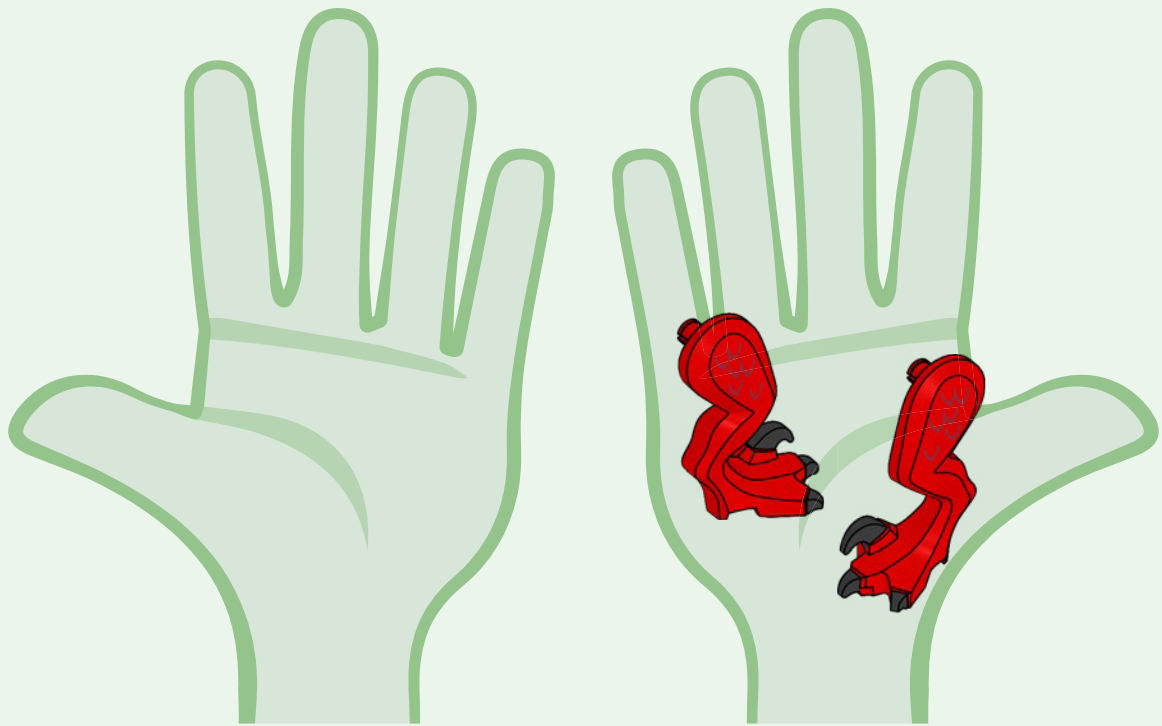

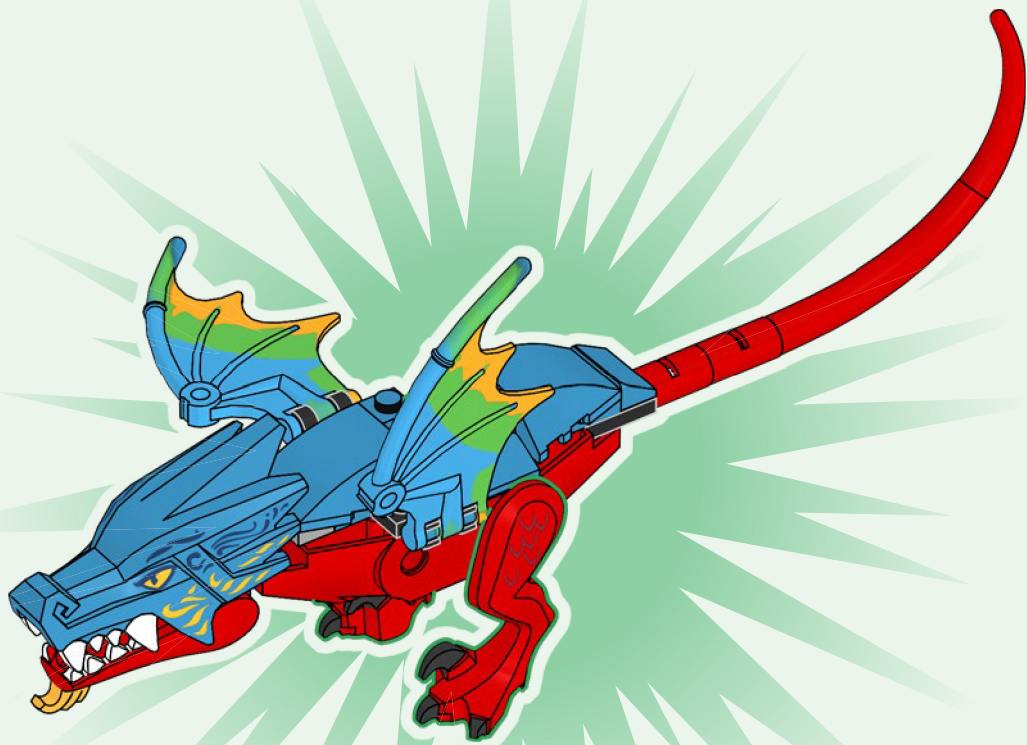

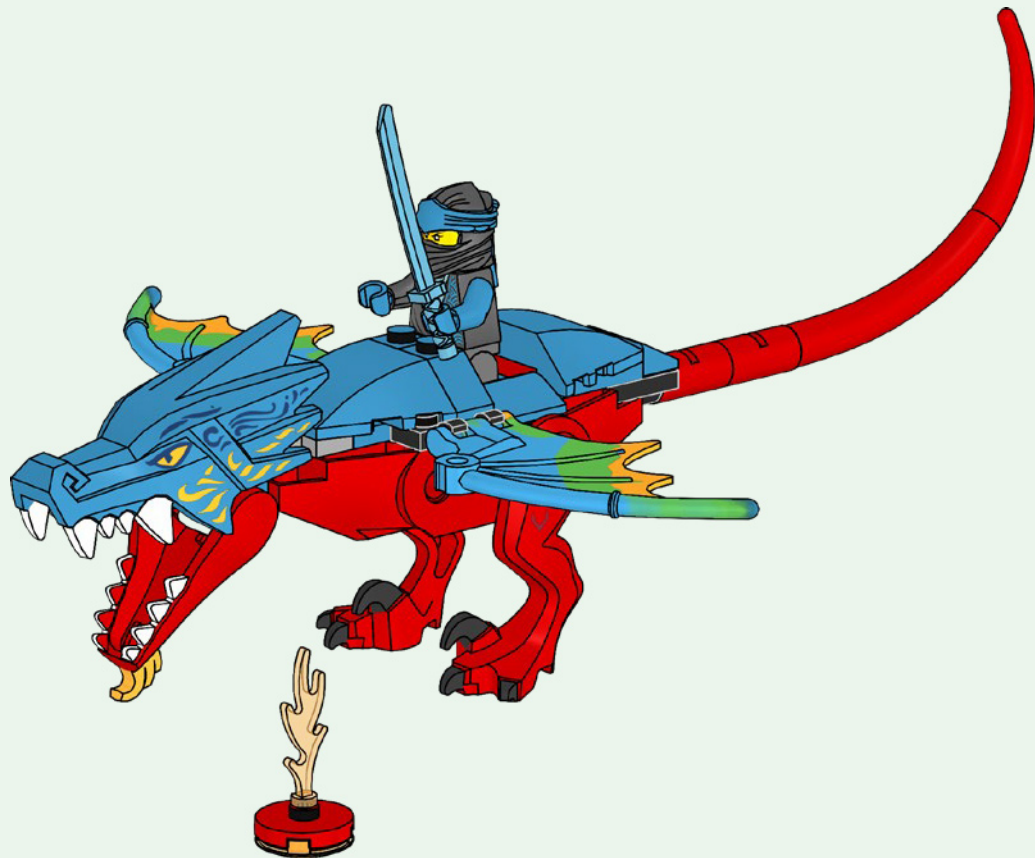



WIN

Terms & Conditions apply

Scan this QR code or go to **LEGO.COM/PRODUCTFEEDBACK** and give us your short feedback about this LEGO® set for a chance to win a cool LEGO prize.



GEWINNE

Scanne diesen QR-Code oder geh auf LEGO.COM/PRODUCTFEEDBACK

und gib uns dein kurzes Feedback zu diesem LEGO® Set. Dann hast du die Chance, einen coolen LEGO Preis zu gewinnen.

Es gelten die Teilnahmebedingungen

GAGNE

Scannez ce code QR ou rendez-vous sur LEGO.COM/PRODUCTFEEDBACK

pour donner votre avis sur ce produit LEGO® et avoir une chance de gagner un prix LEGO.

Voir Conditions Générales

GANAN

Escanea este código QR o visita LEGO.COM/PRODUCTFEEDBACK

y comparte con nosotros tu opinión sobre este set LEGO® para tener la oportunidad de ganar un fantástico premio LEGO.

Términos y Condiciones aplicables

获取奖品

只需扫描此二维码或访问 LEGO.COM/PRODUCTFEEDBACK,

就这款乐高®套装提供简短反馈,就有机会赢得很酷的乐高奖品。

《条款及条件》适用

LEGO, the LEGO logo and NINJAGO are trademarks of the LEGO Group. ©2022 The LEGO Group.

6415212



NINJAGO

71759



2



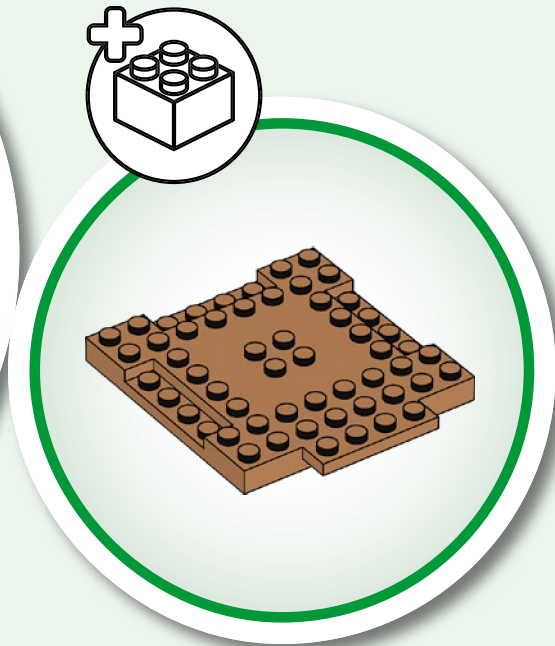

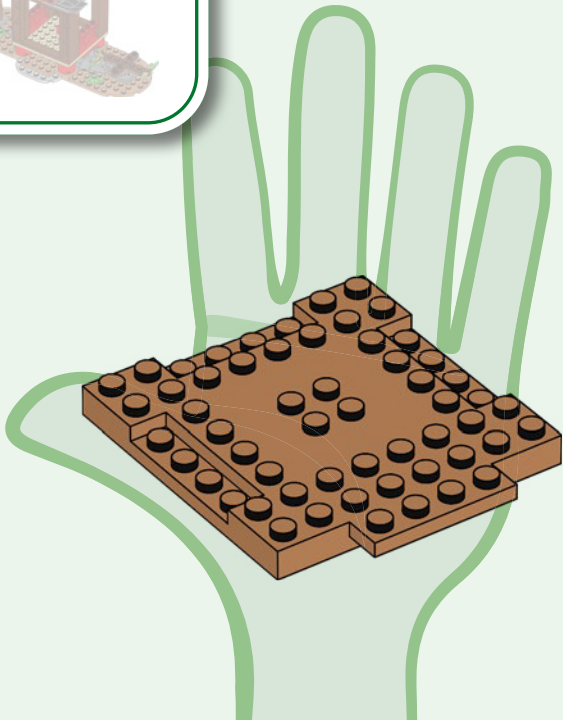

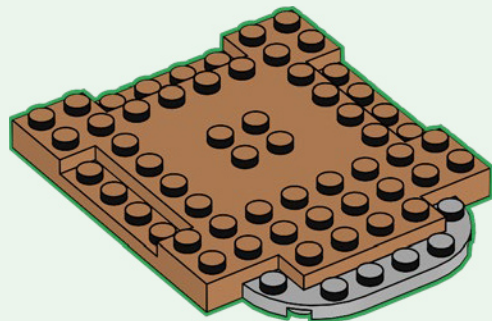

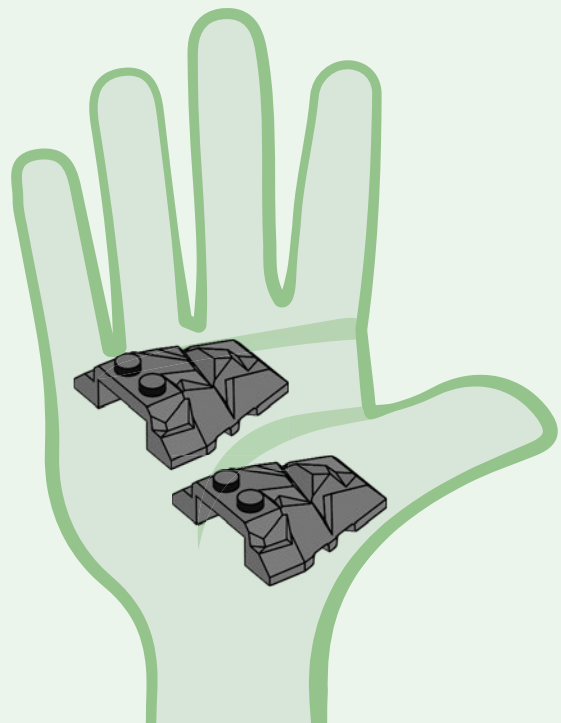
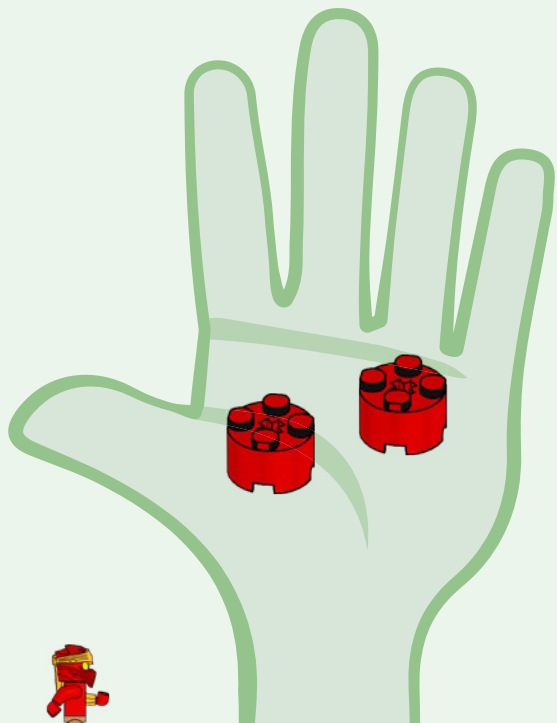

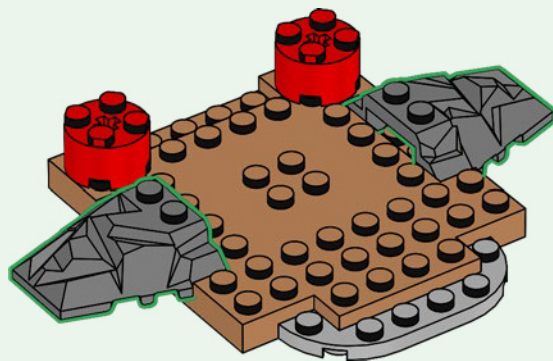
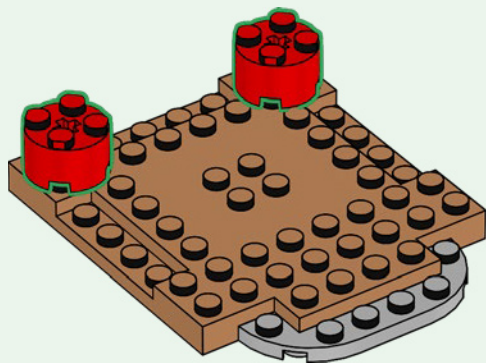

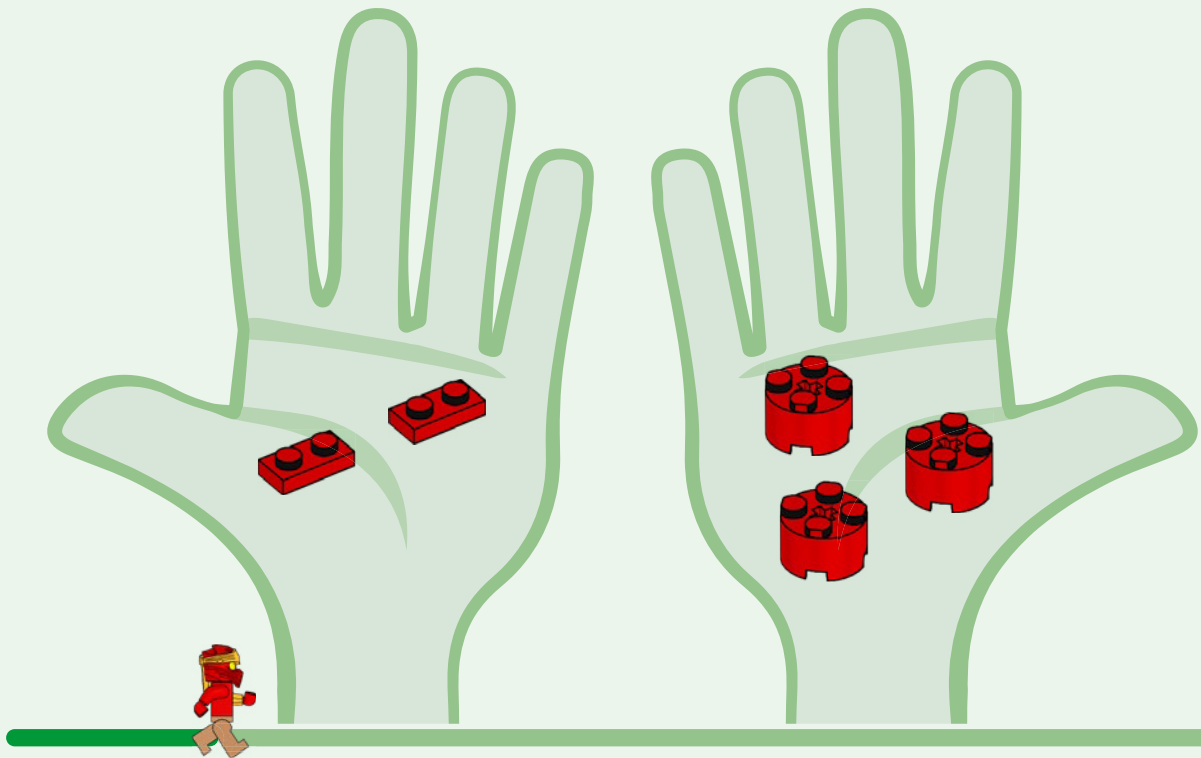

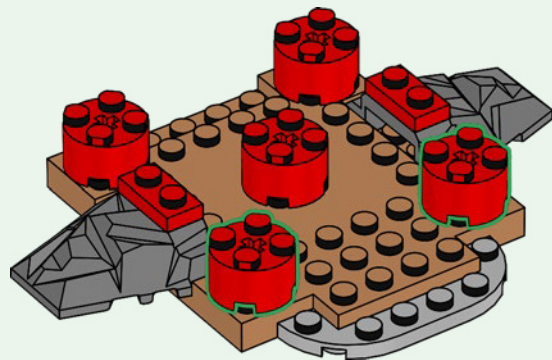
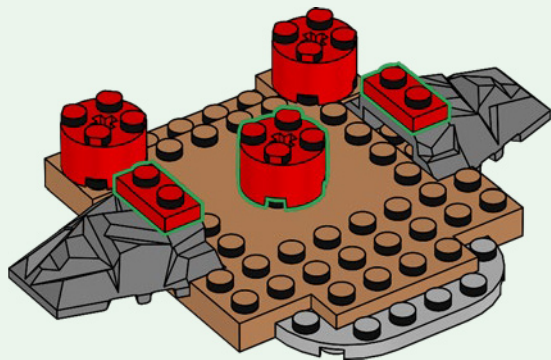

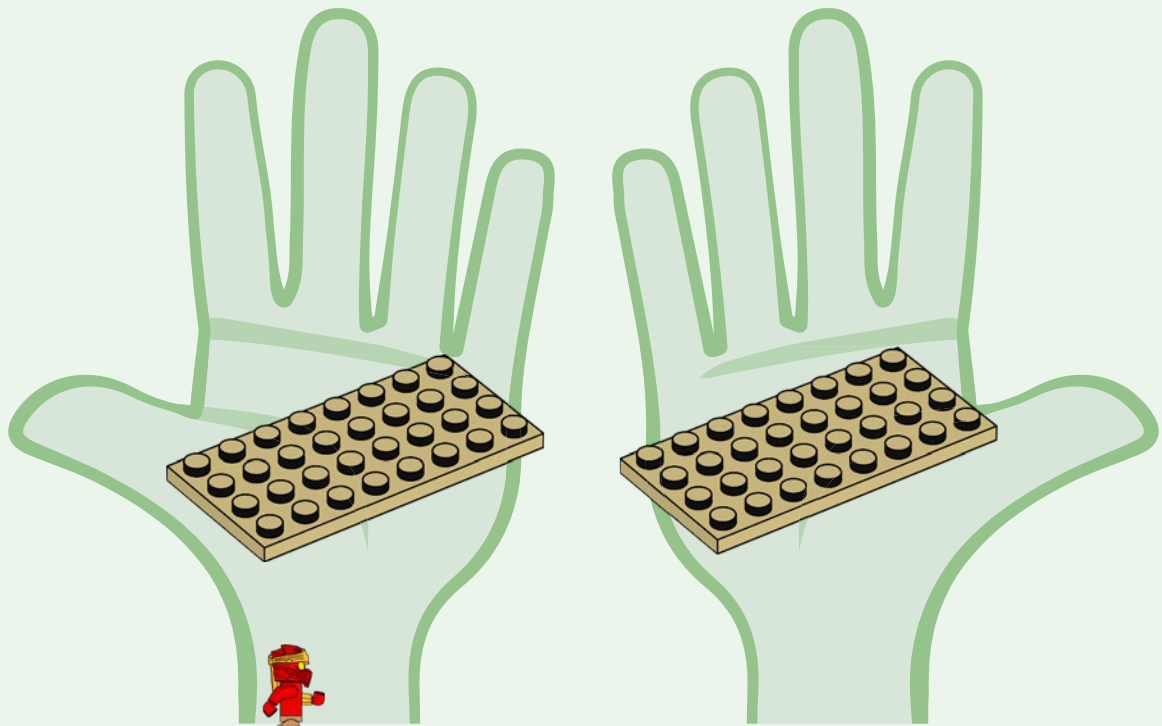

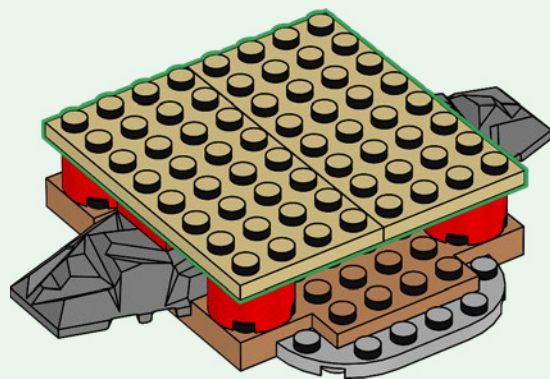

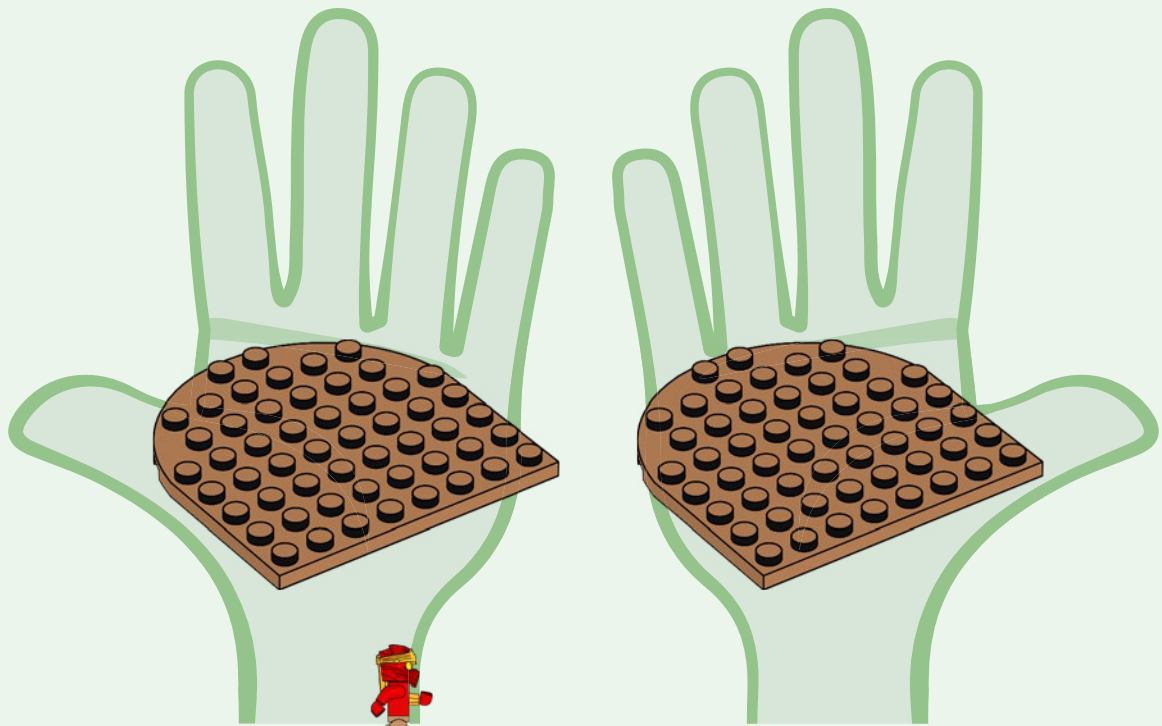

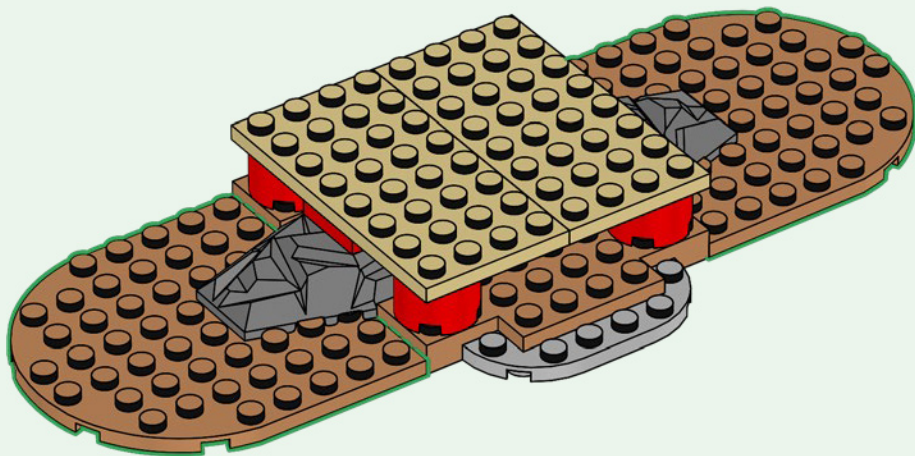

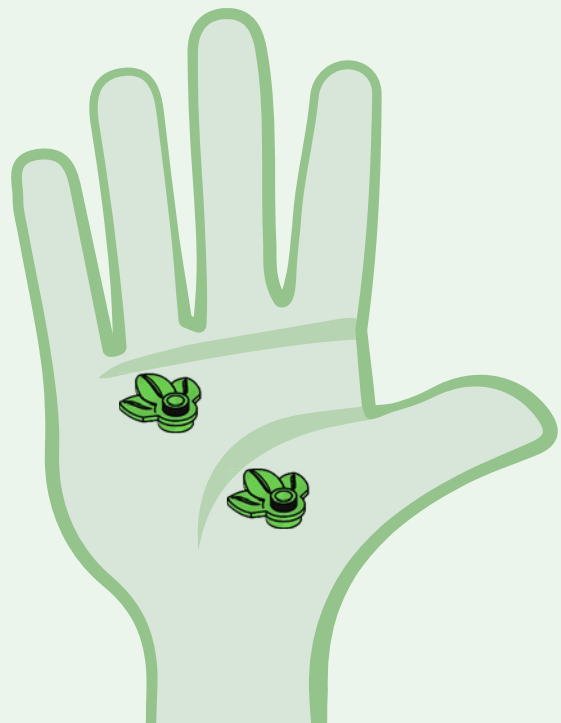
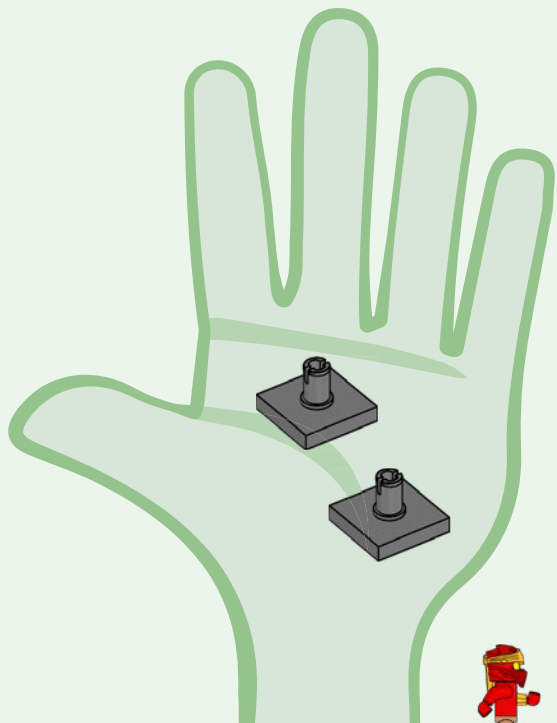

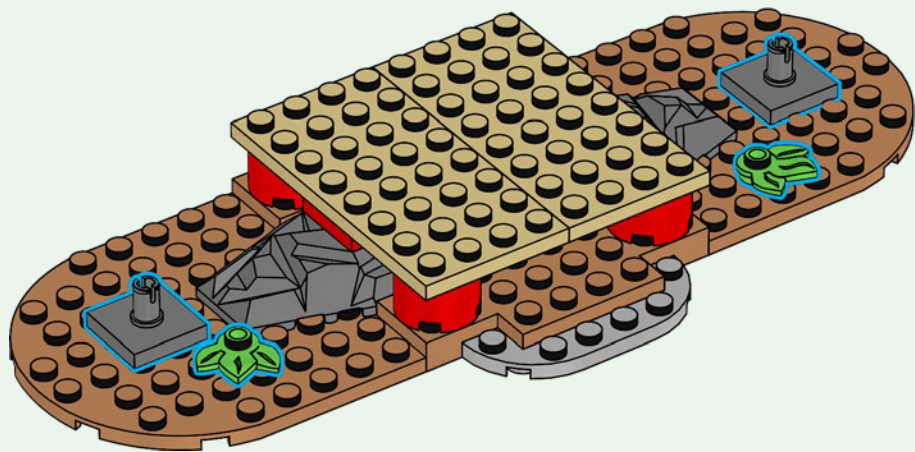

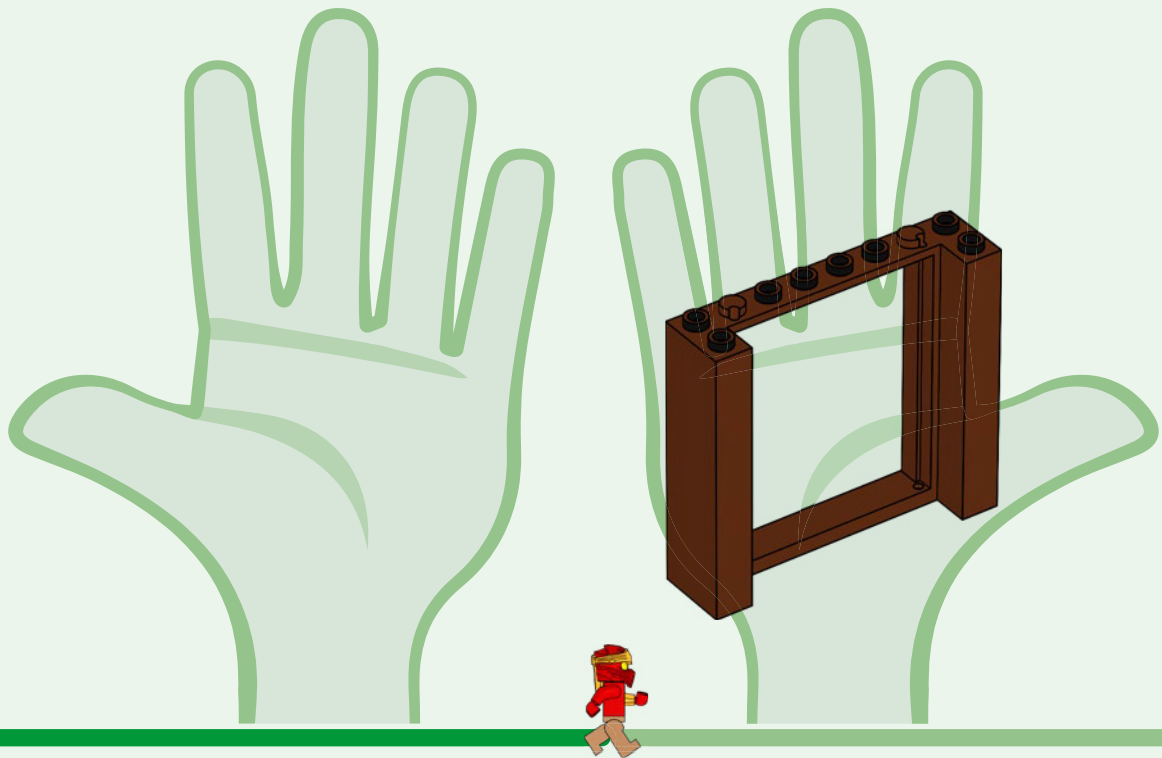

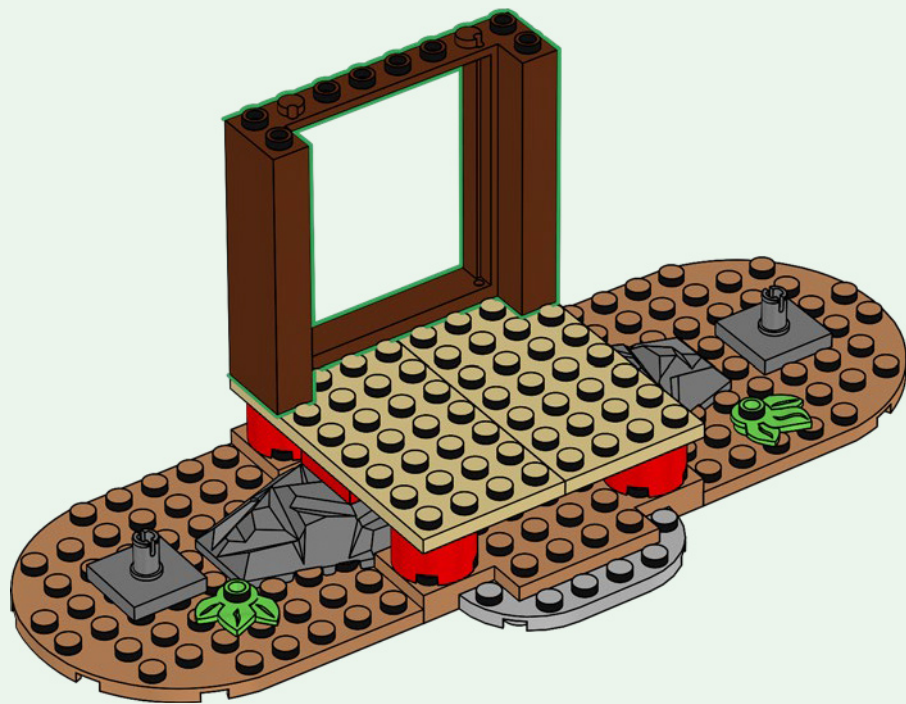

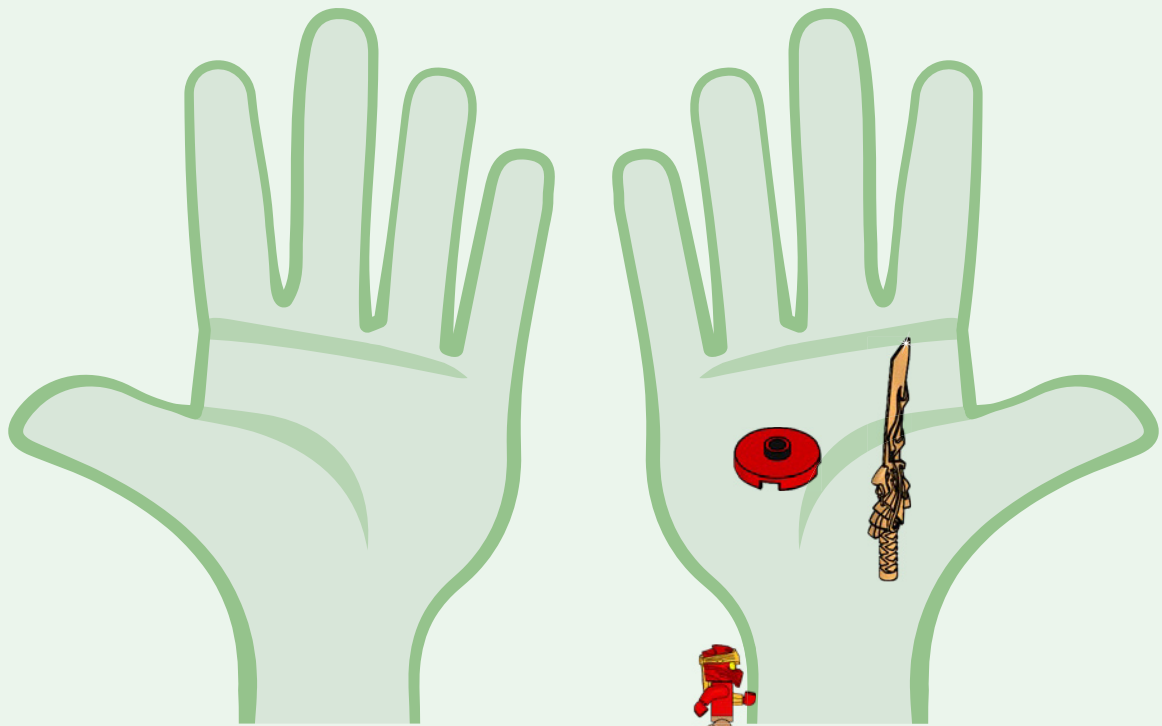

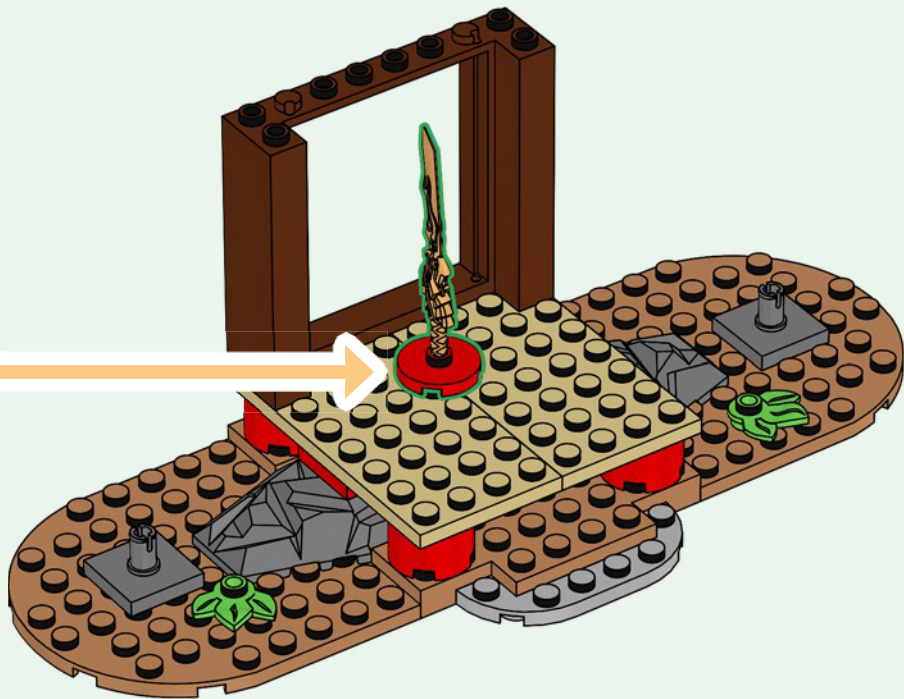
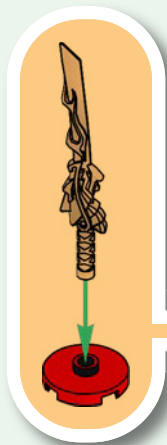

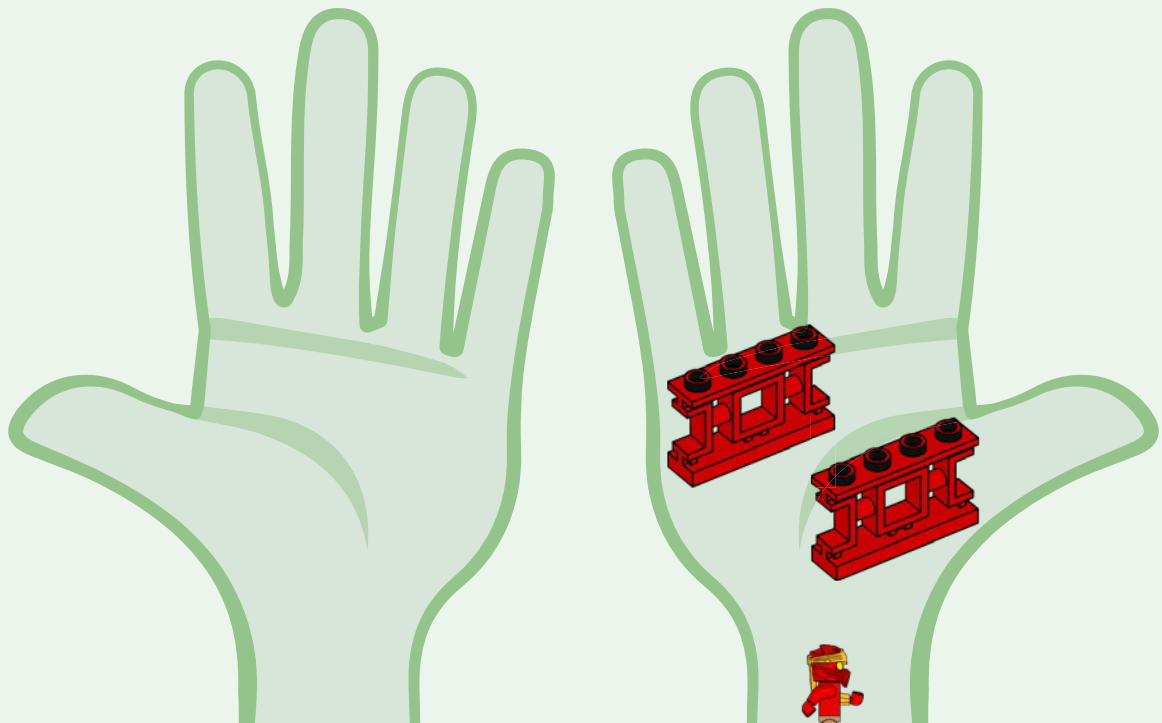

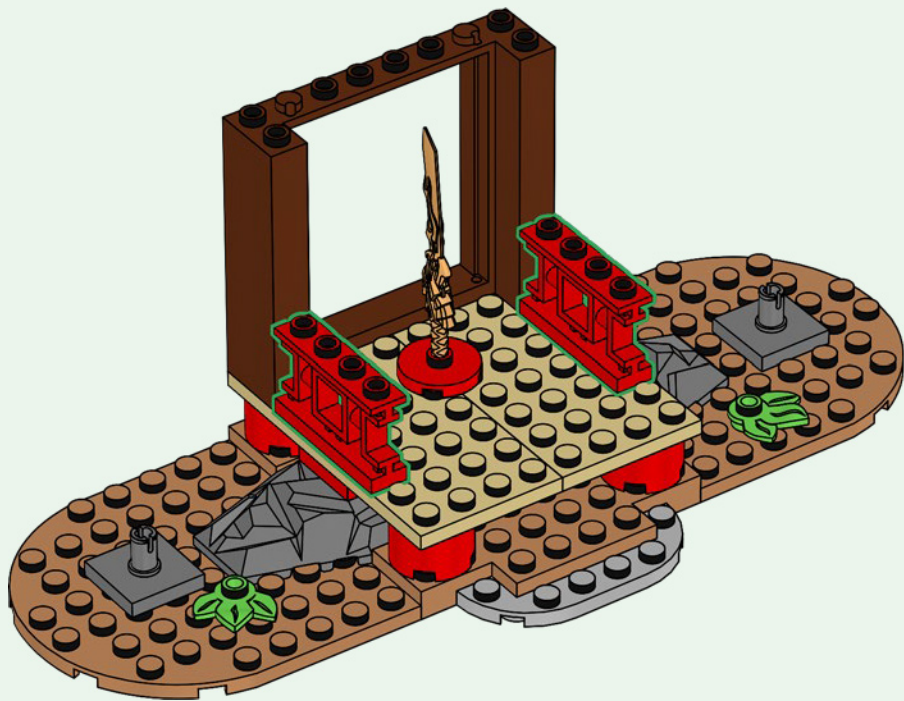

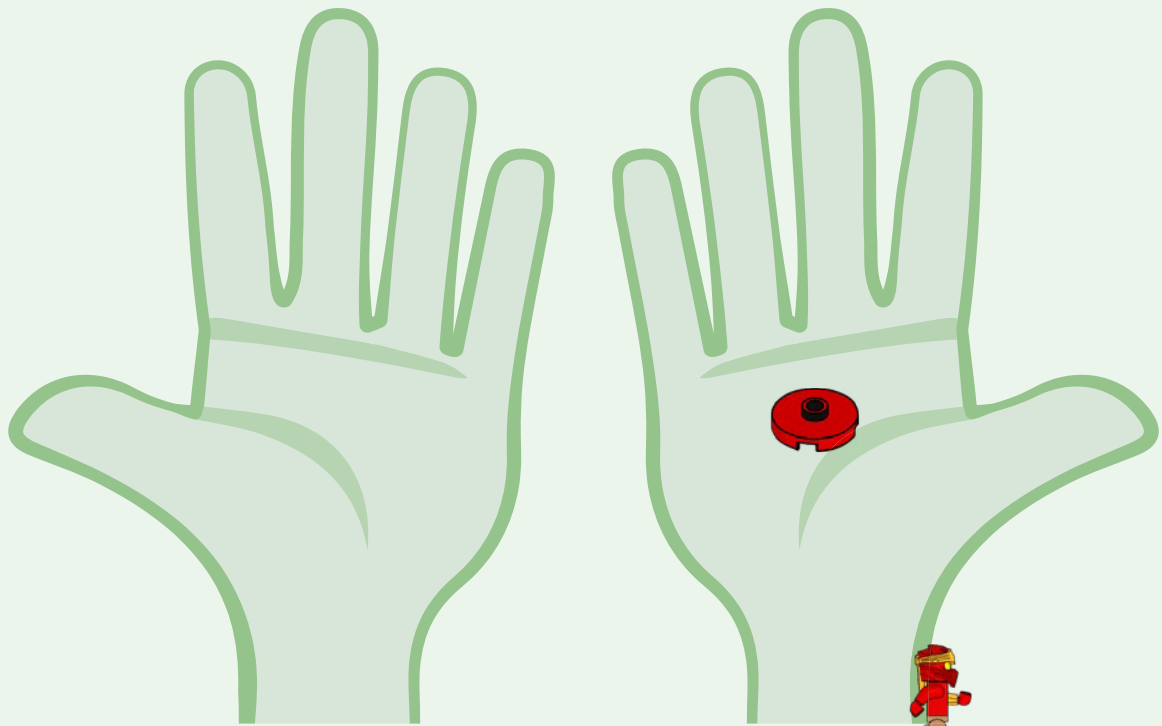

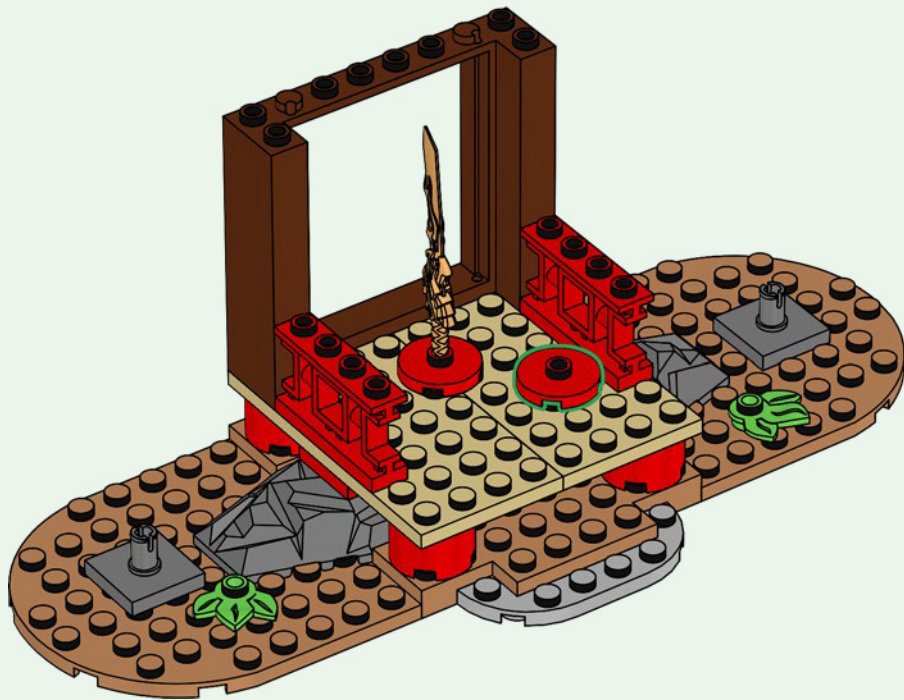

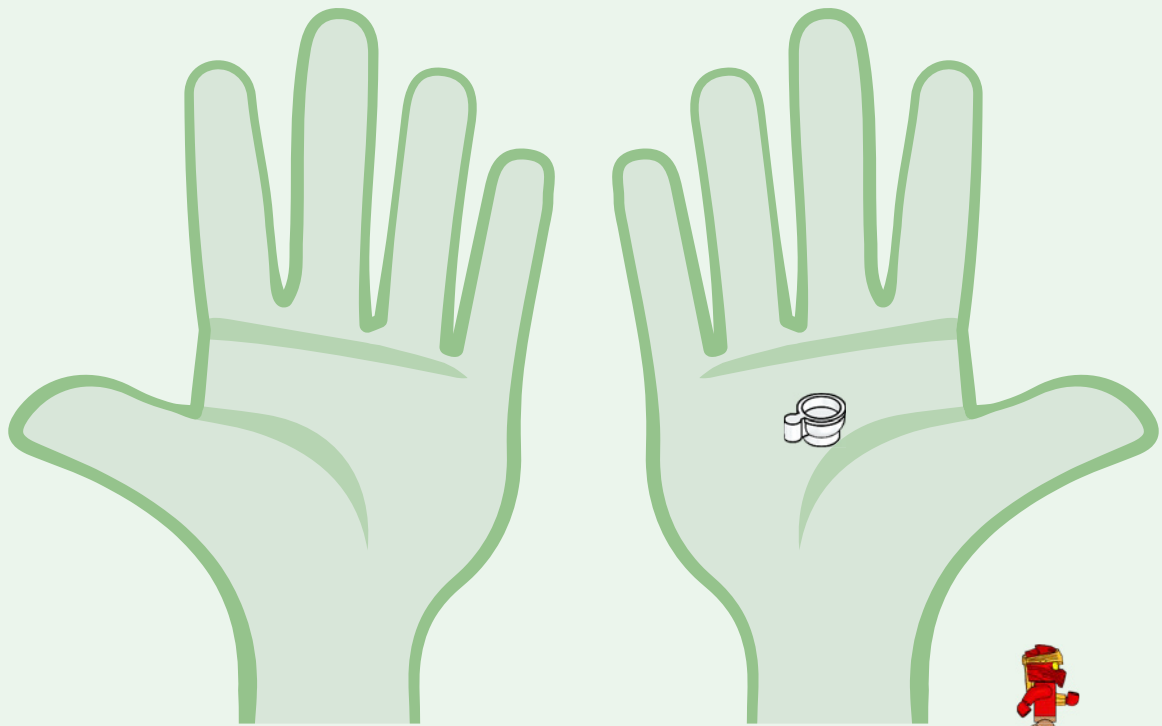

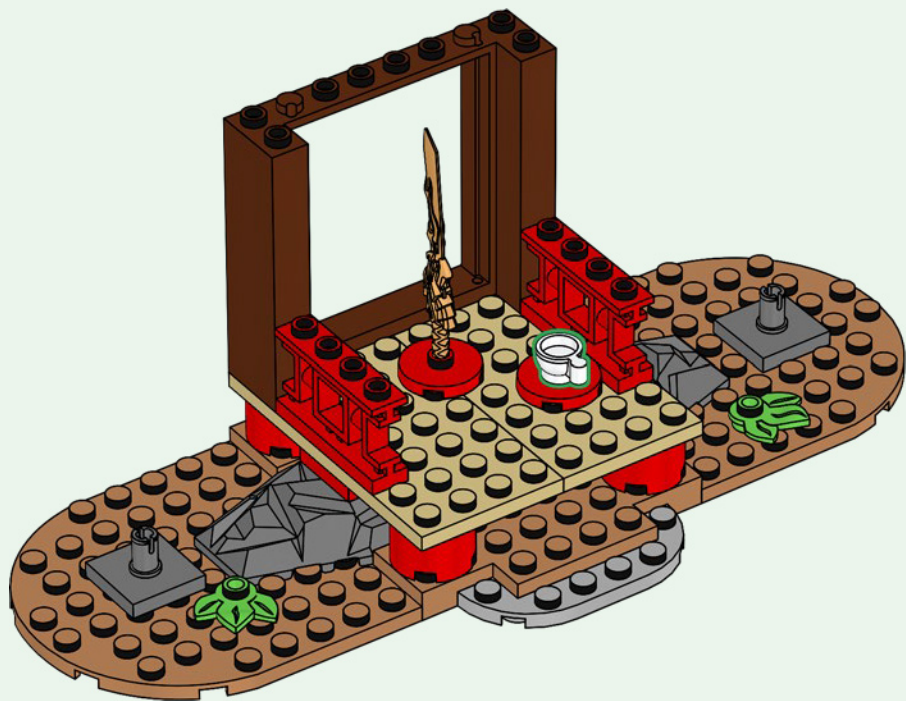

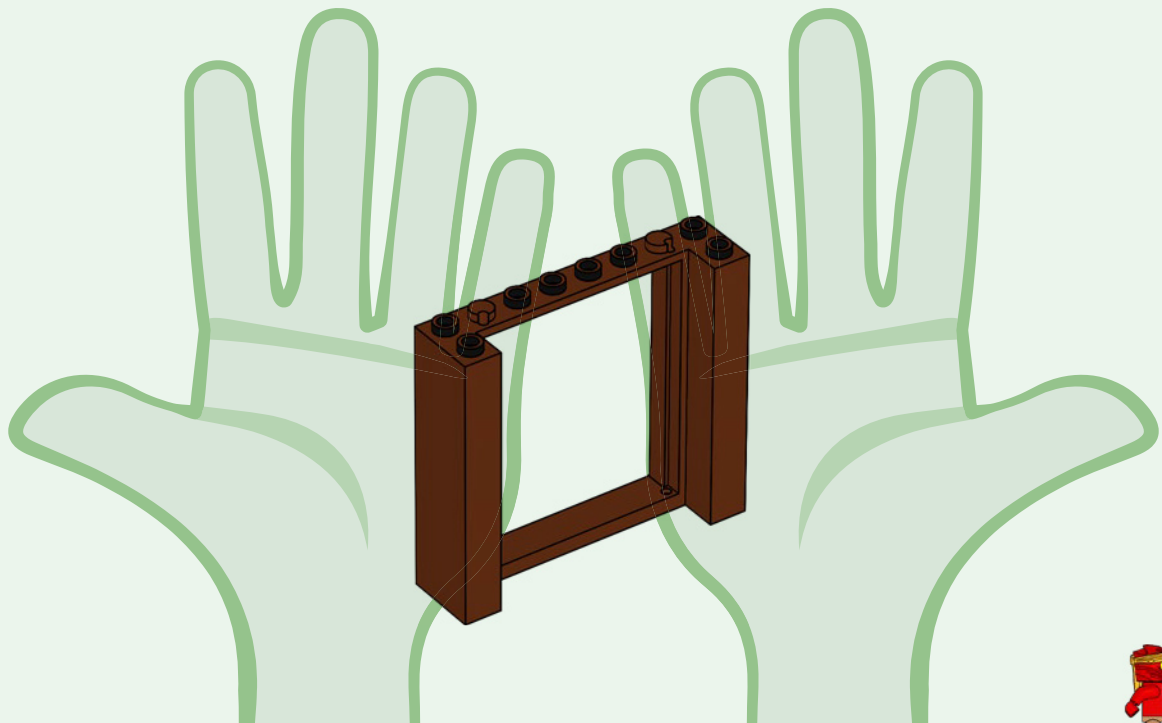

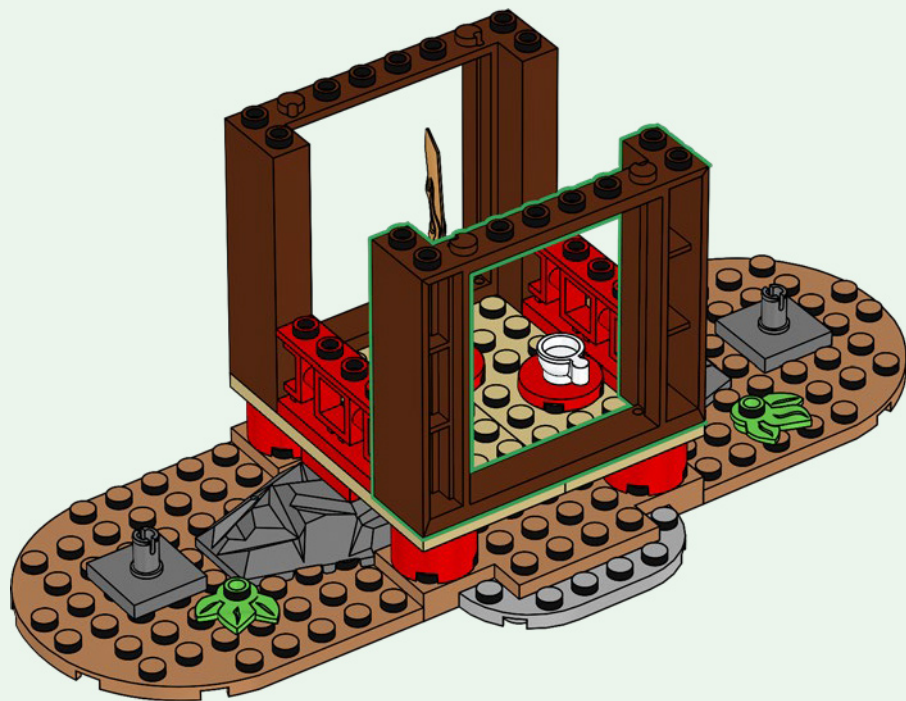

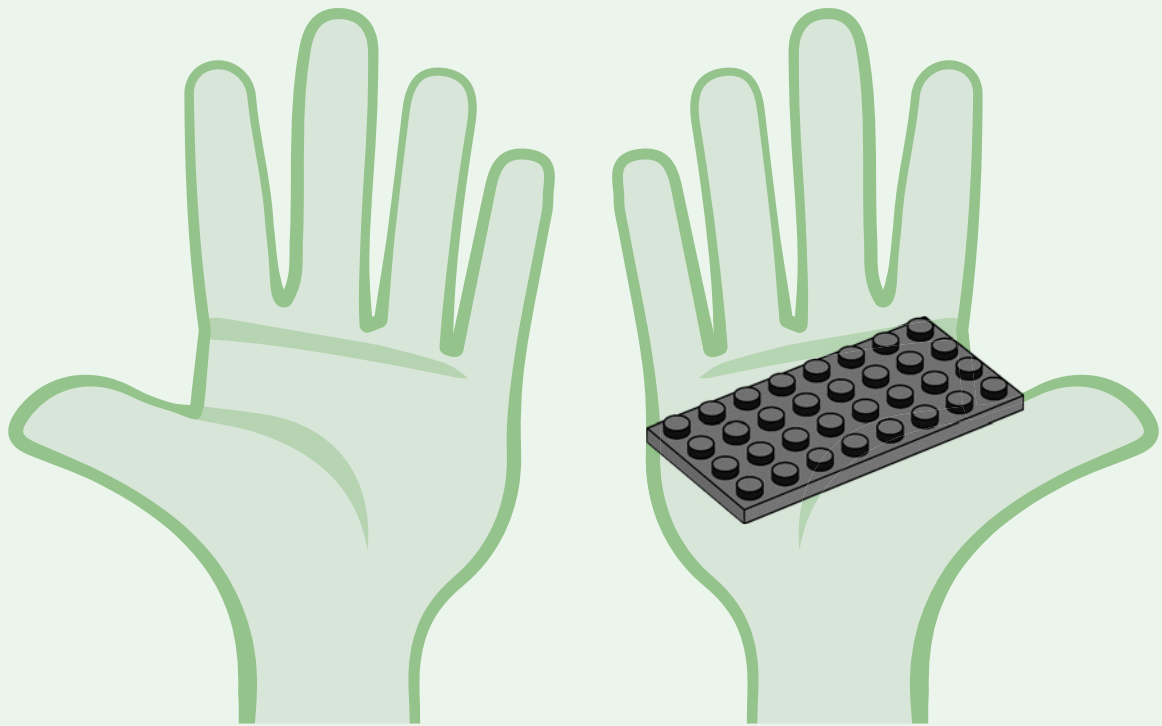

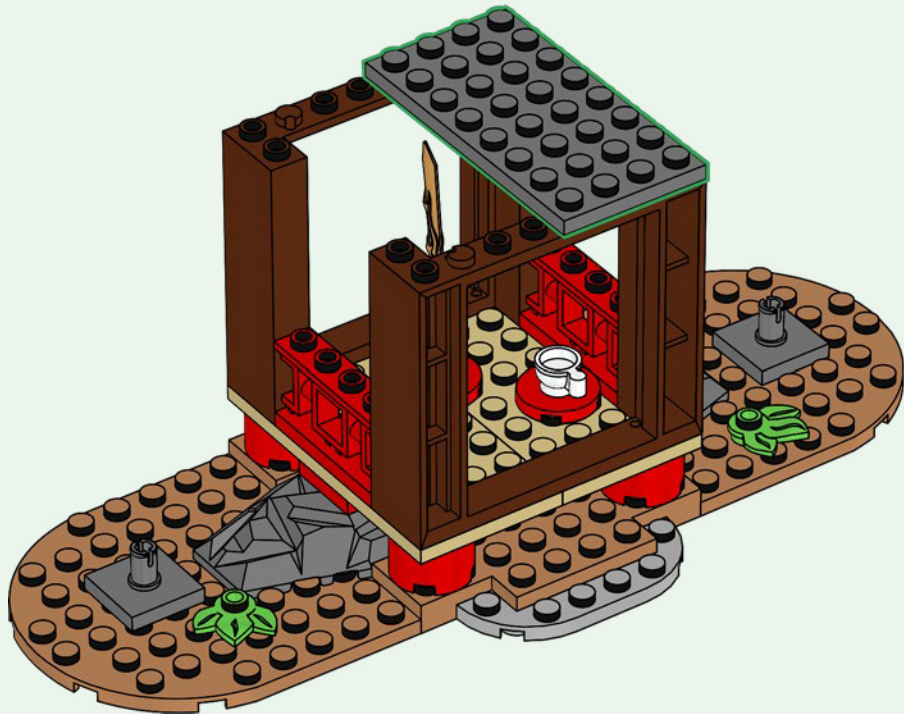

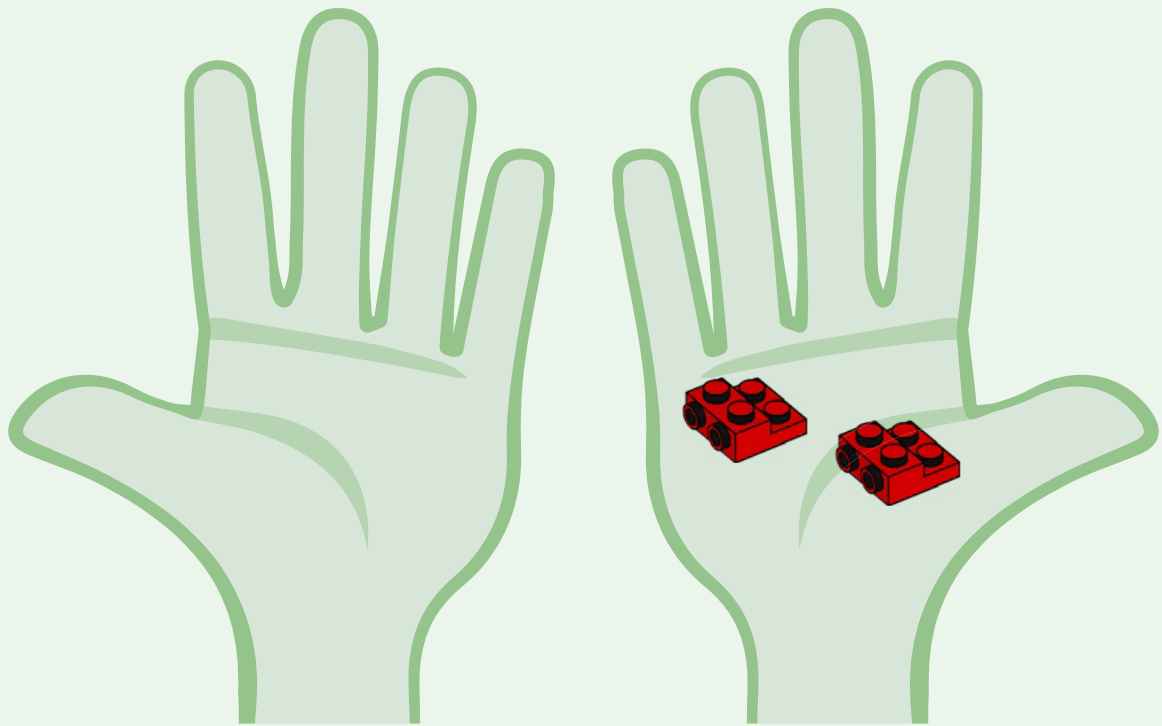

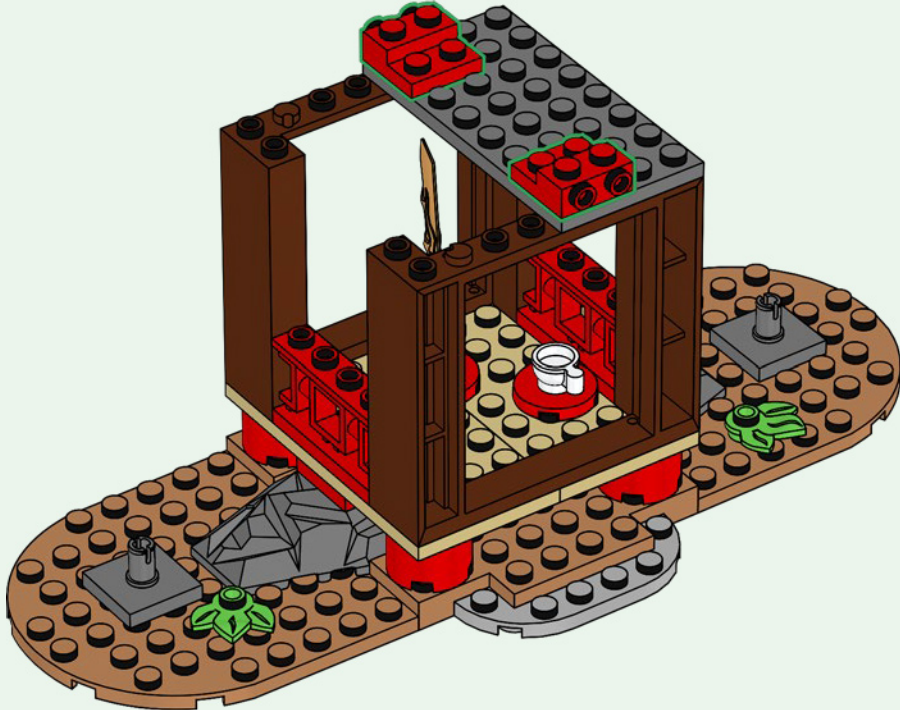

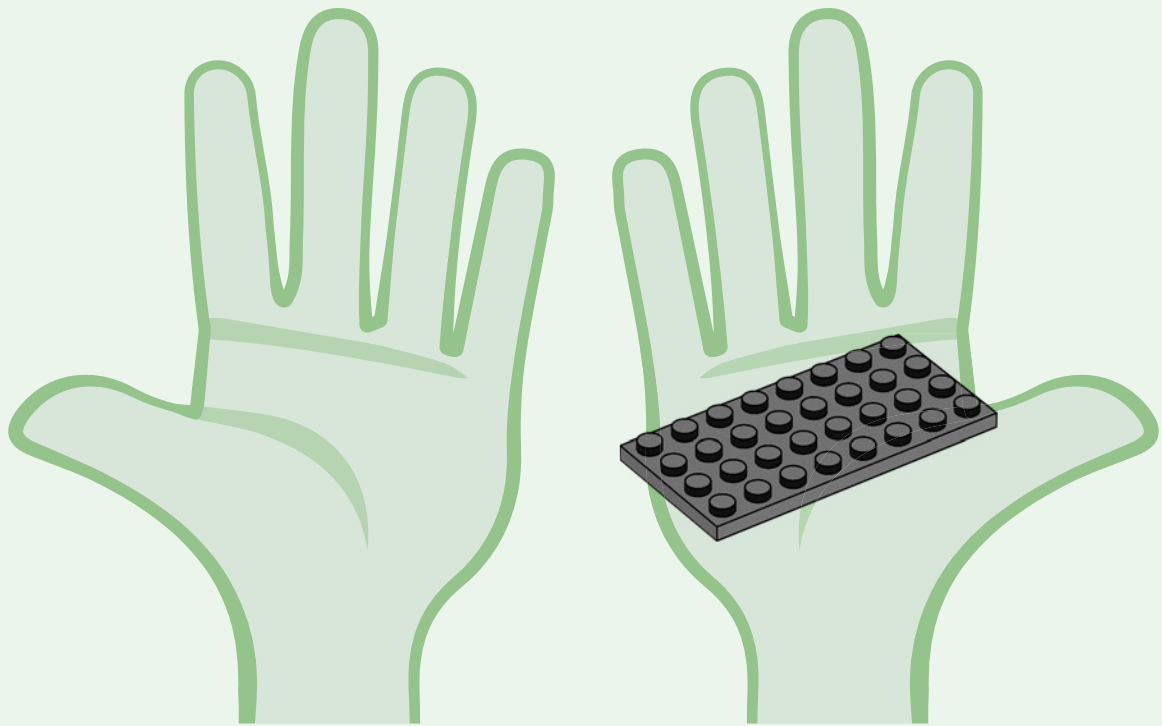

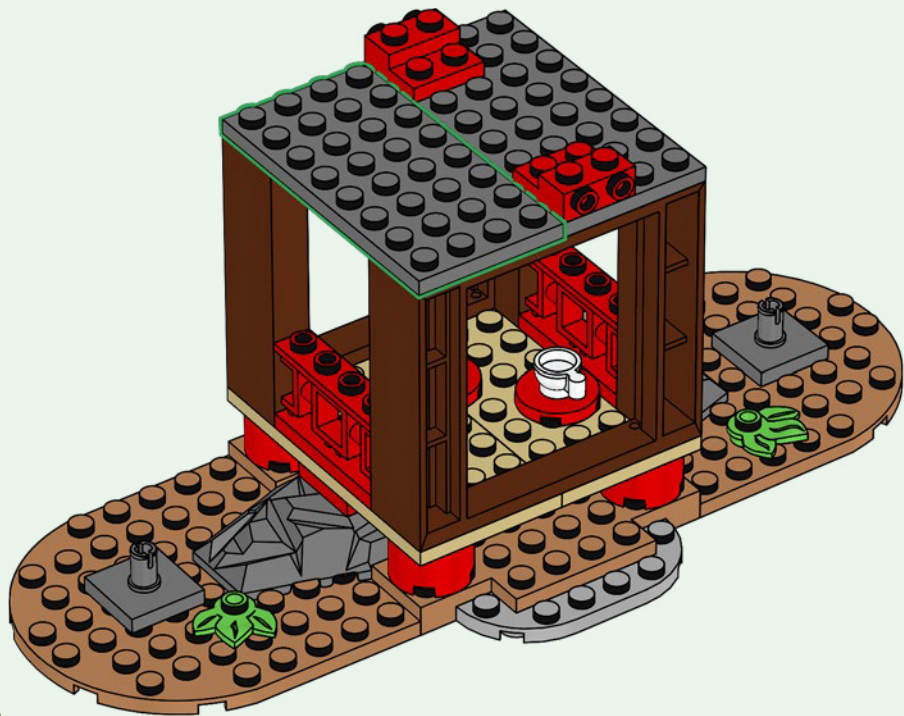

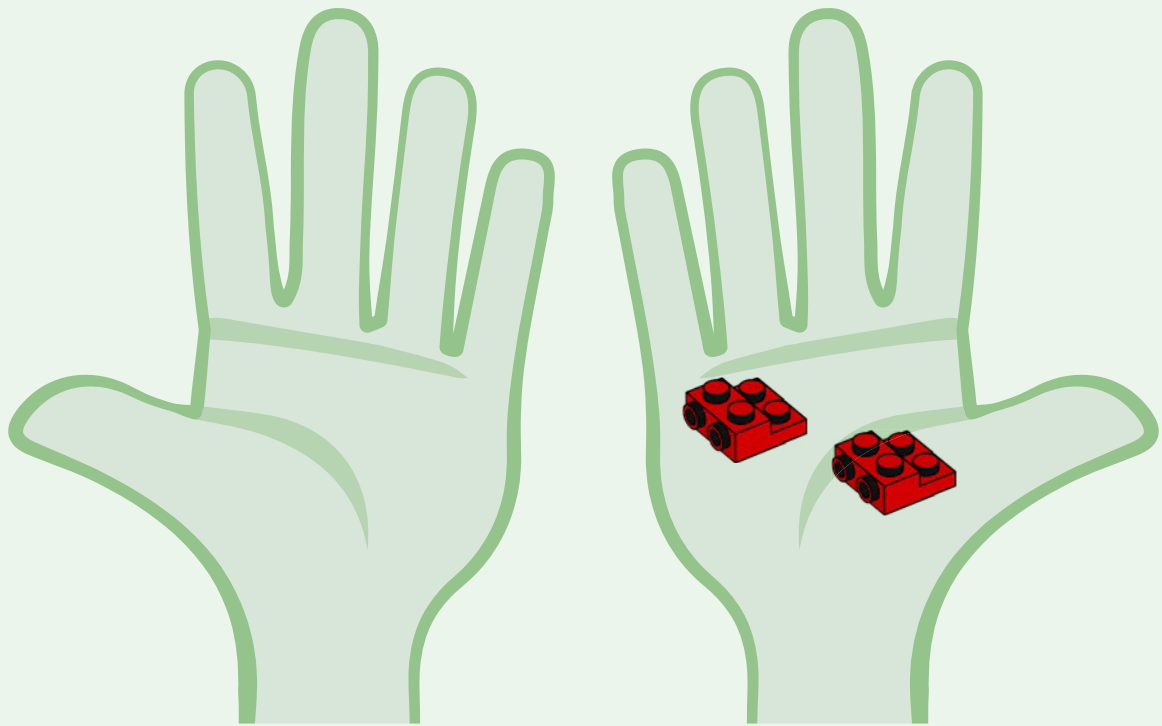

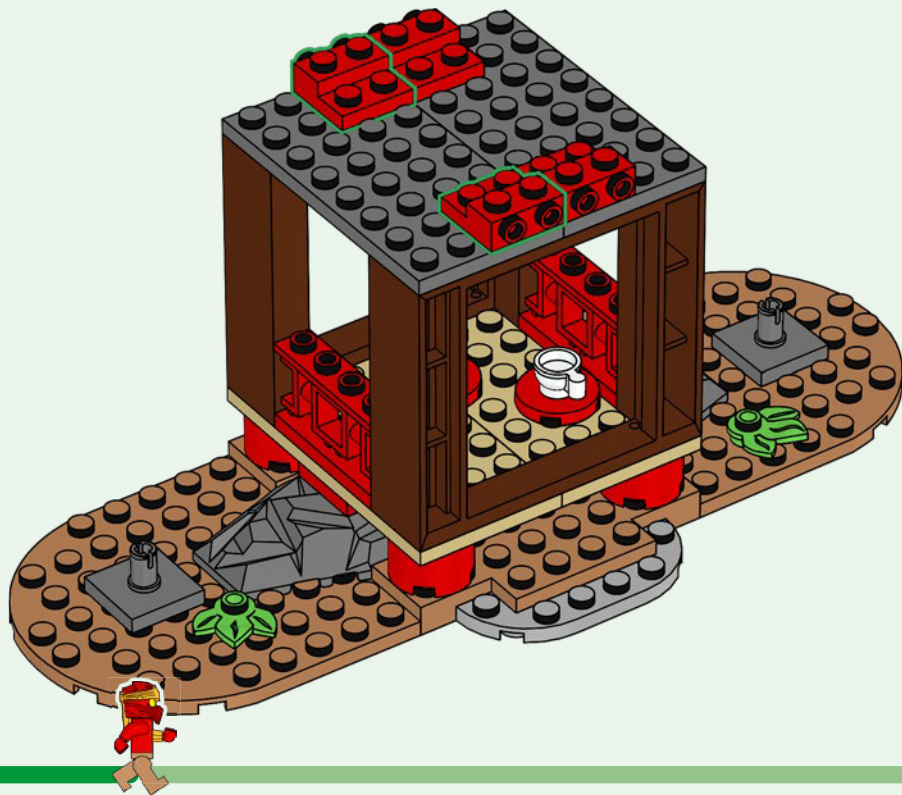



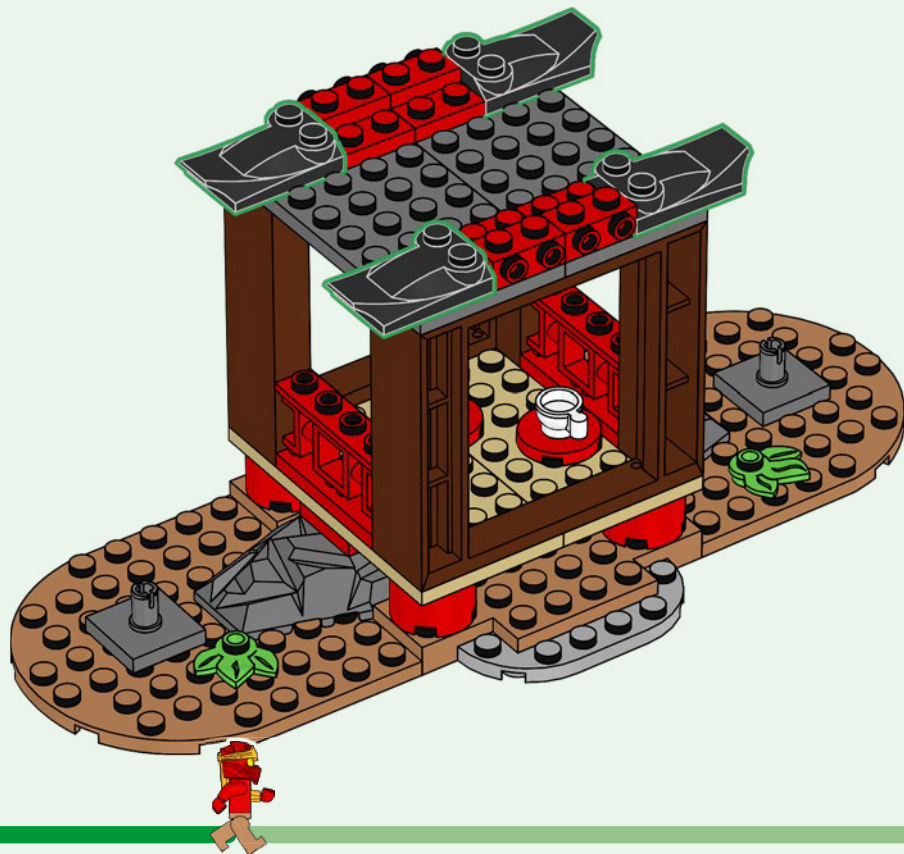

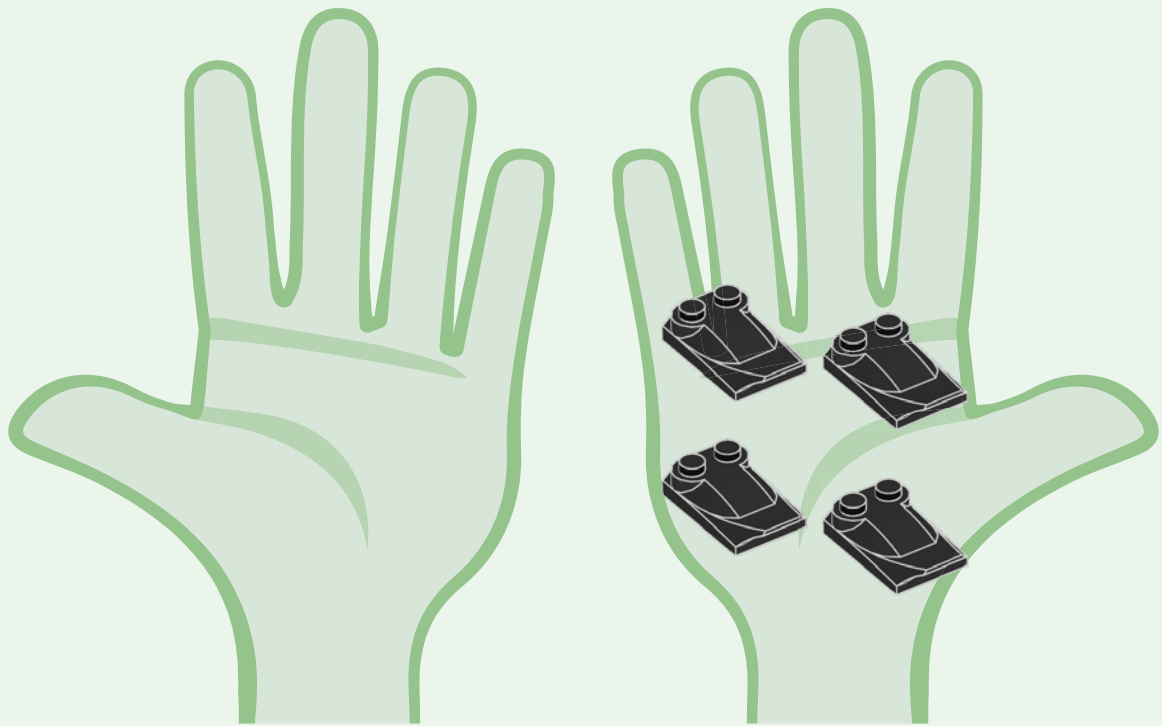

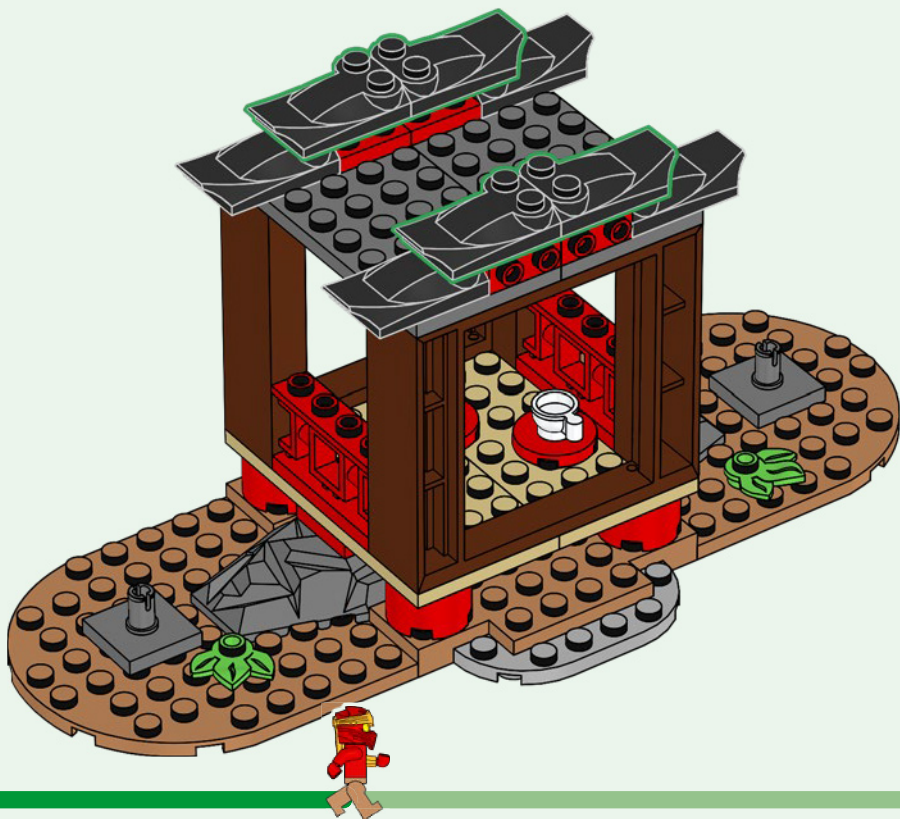

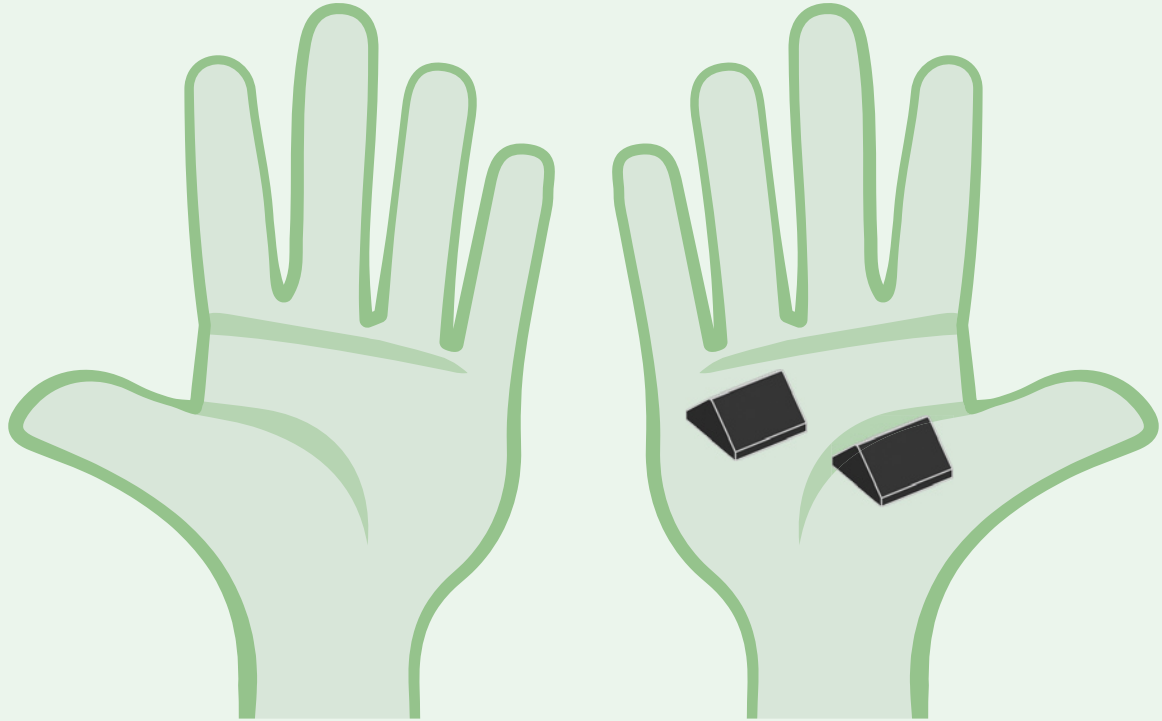

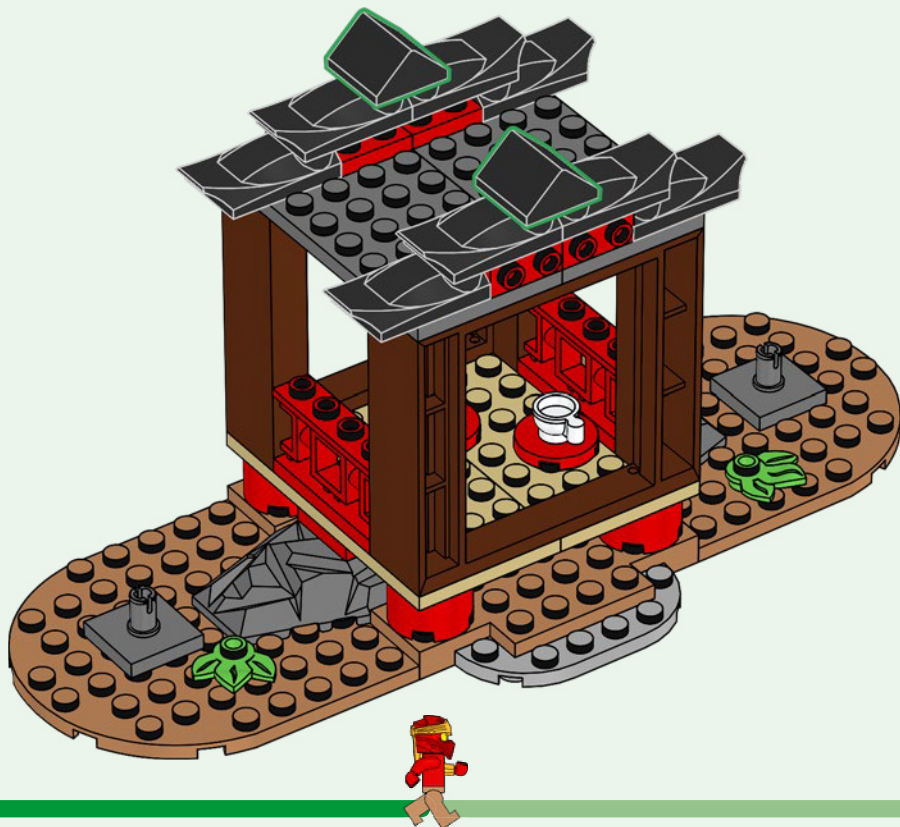

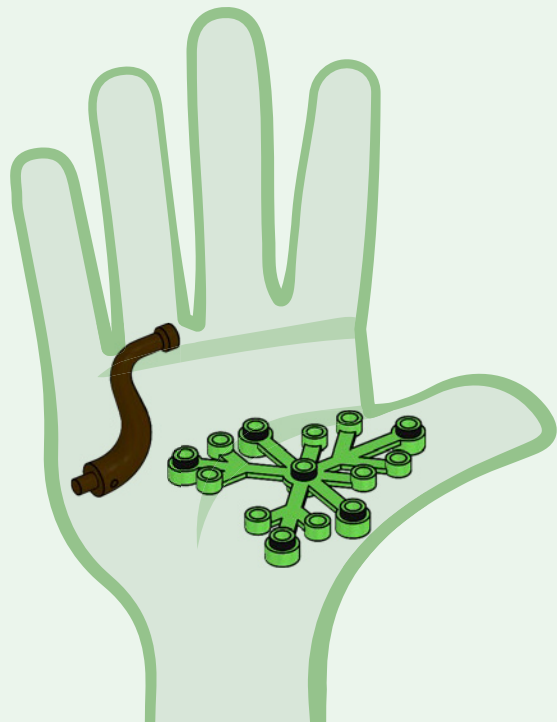

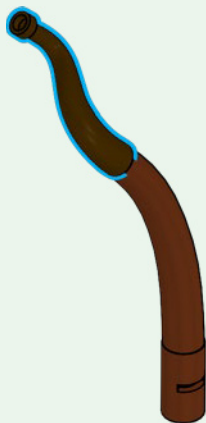
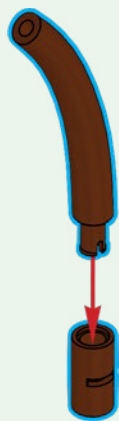





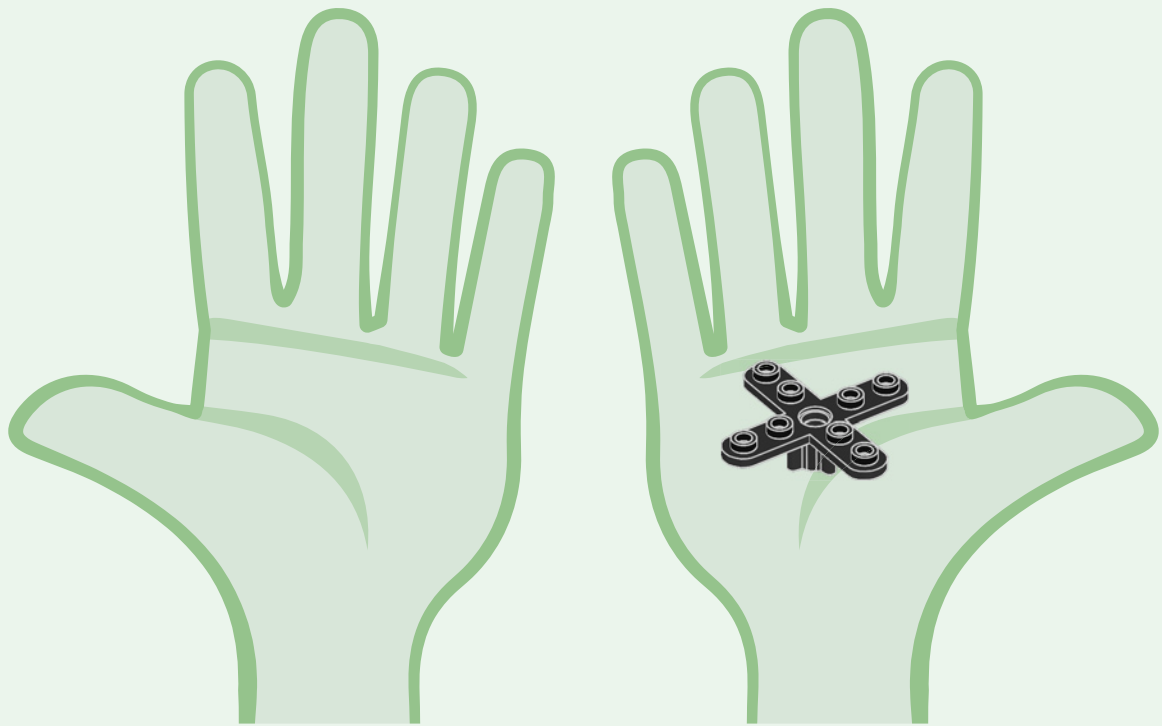



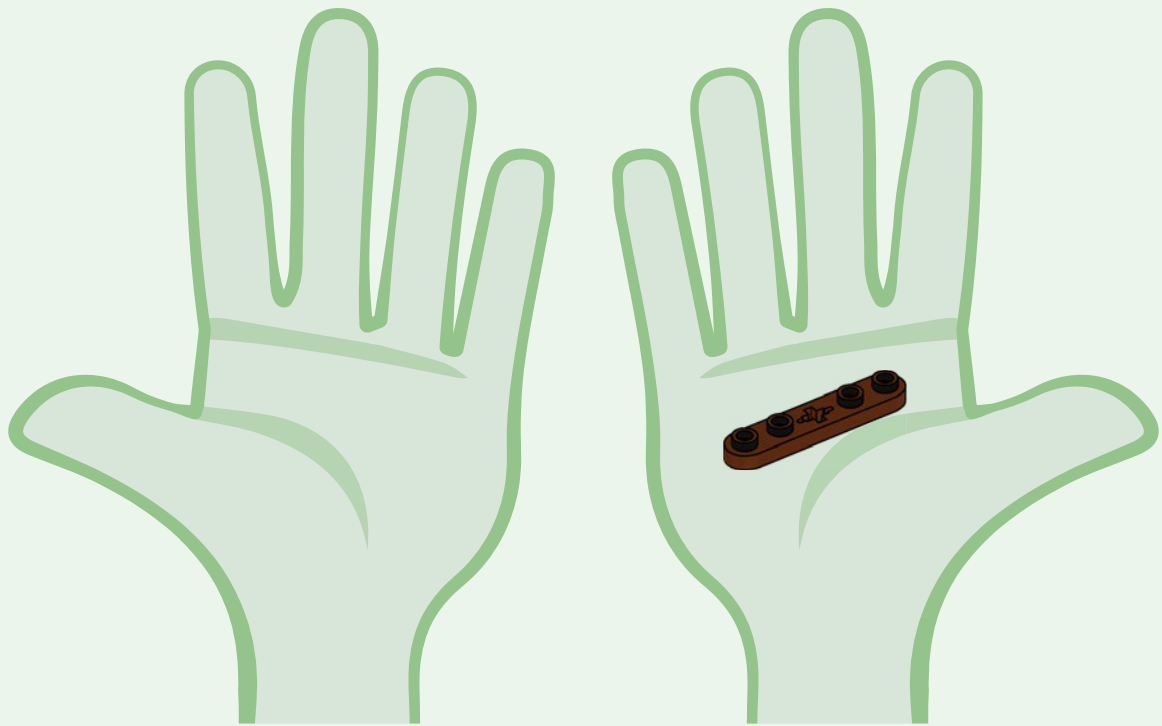



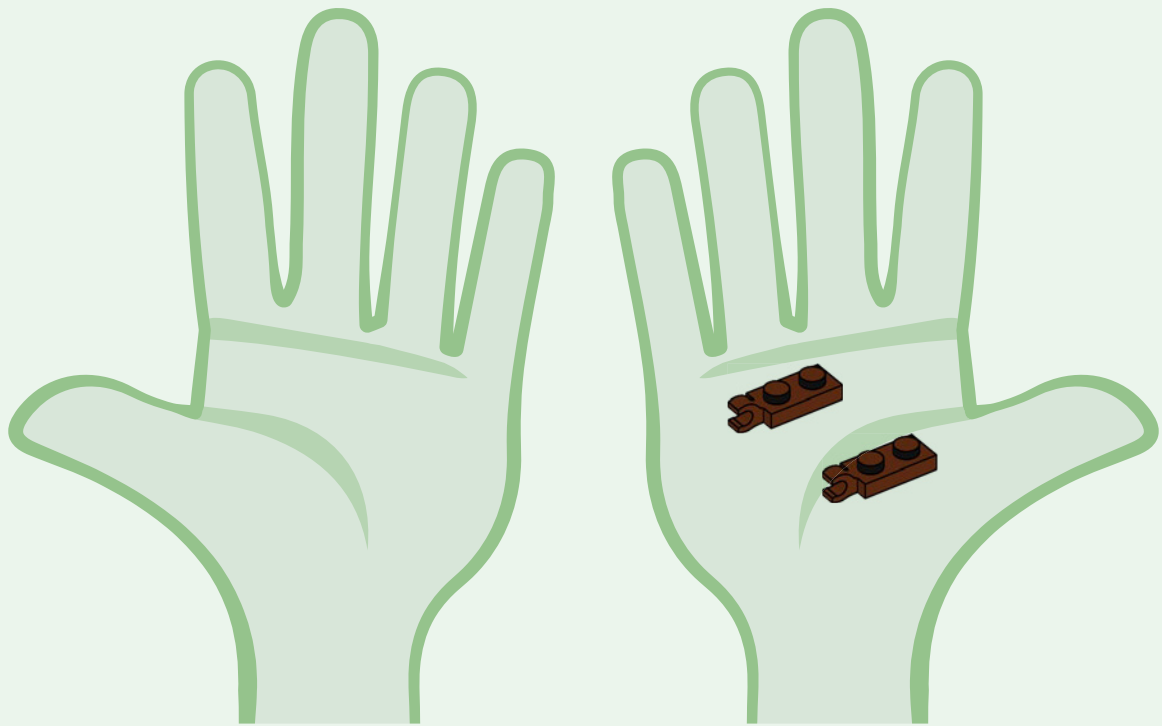



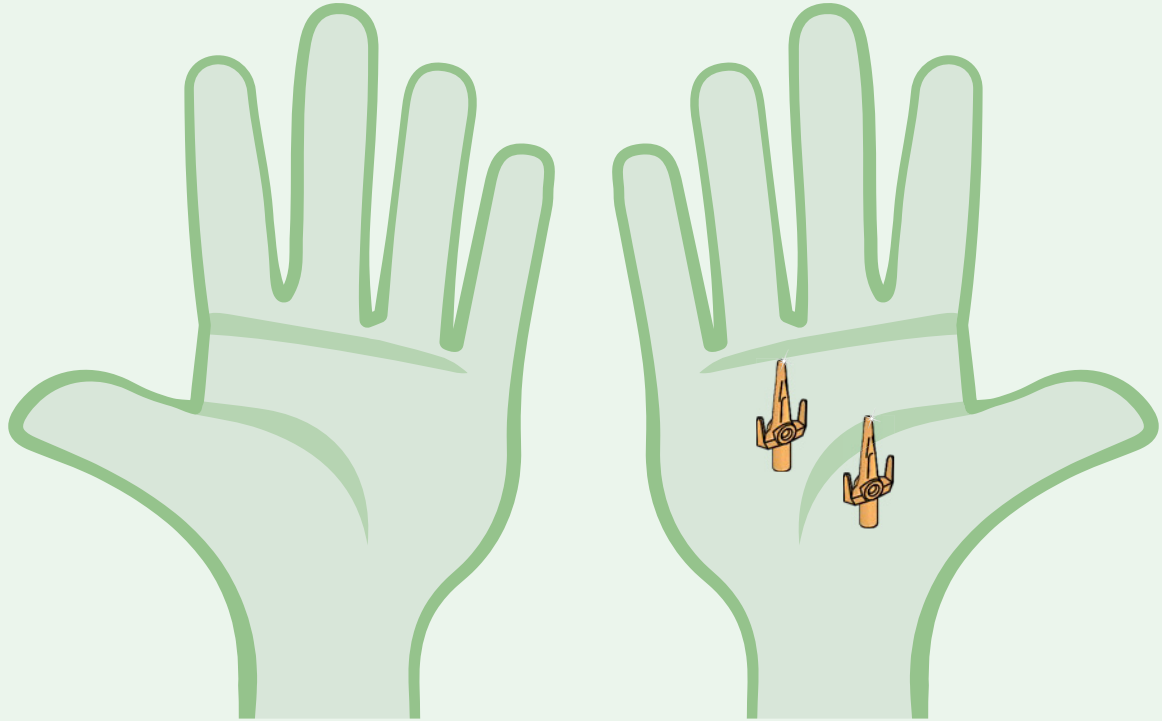

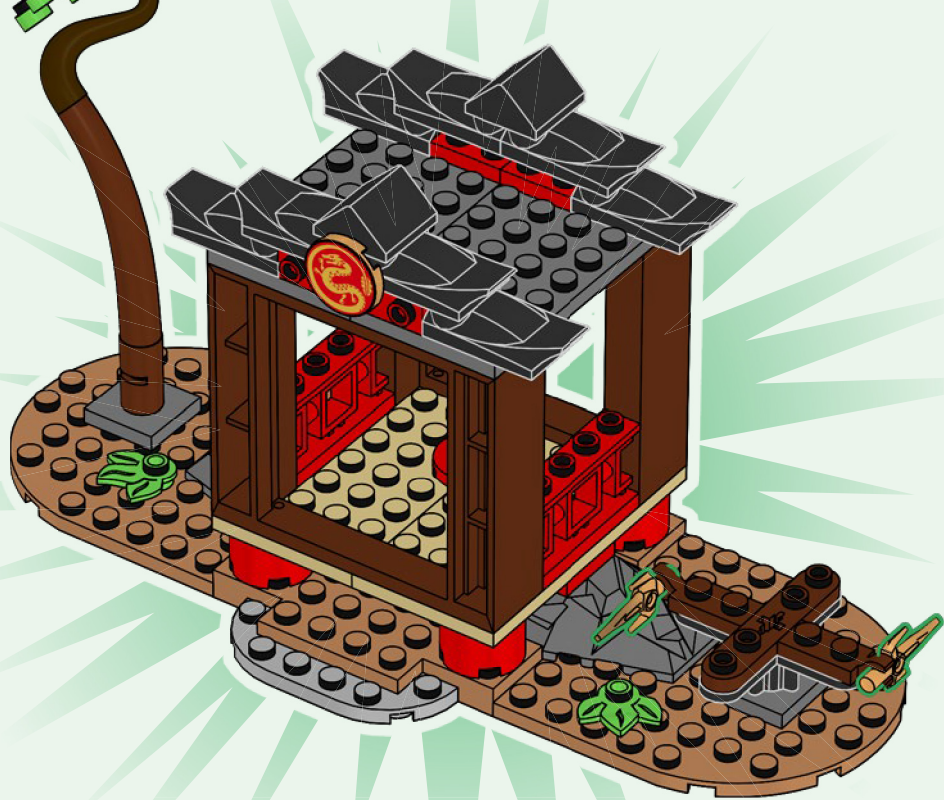







Rebuild
the
world™



LEGO, the LEGO logo and NINJAGO are trademarks of the LEGO Group.
©2022 The LEGO Group. 6415214



NINJAGO

71759







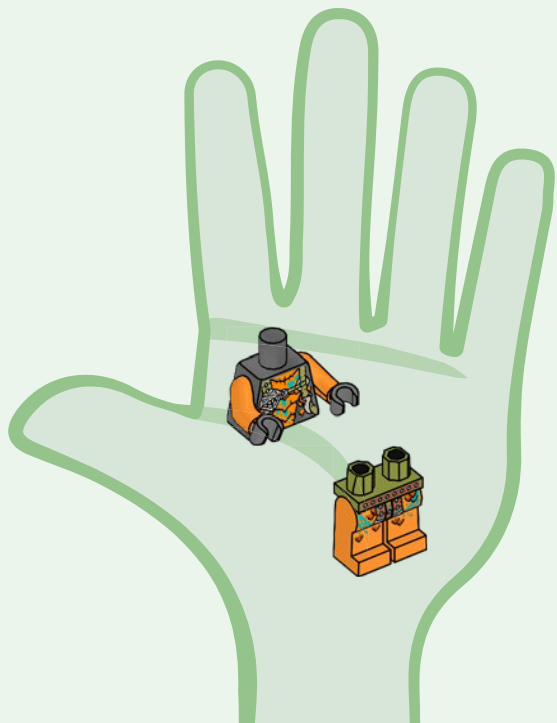

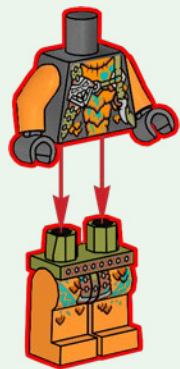

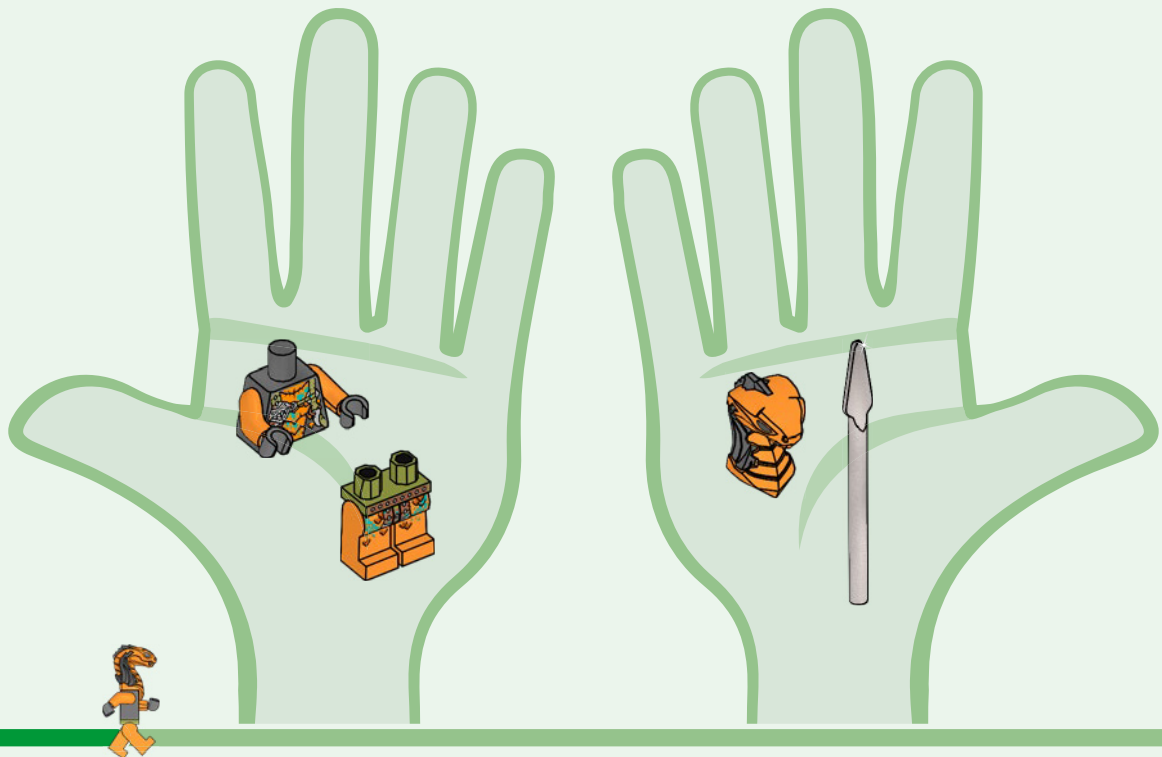

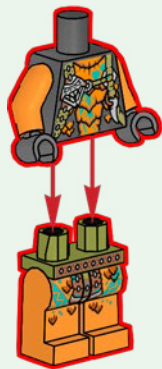

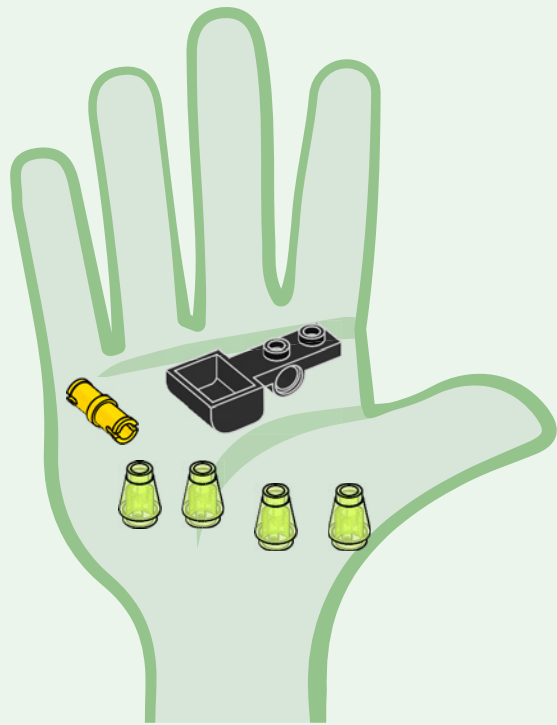
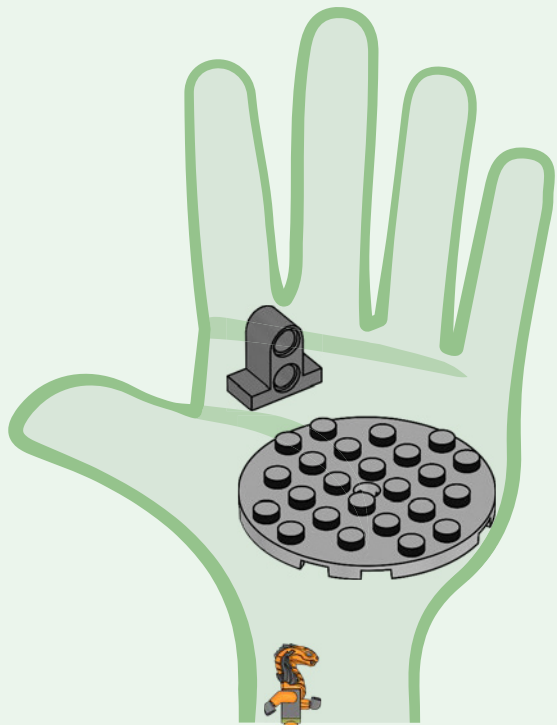

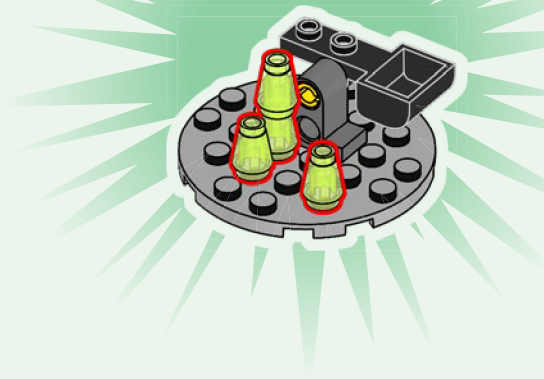
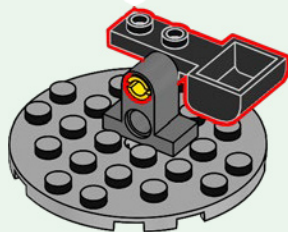
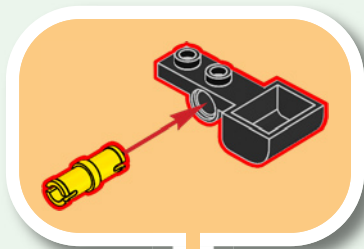
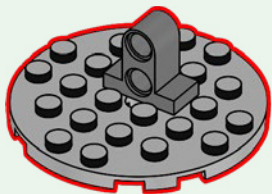

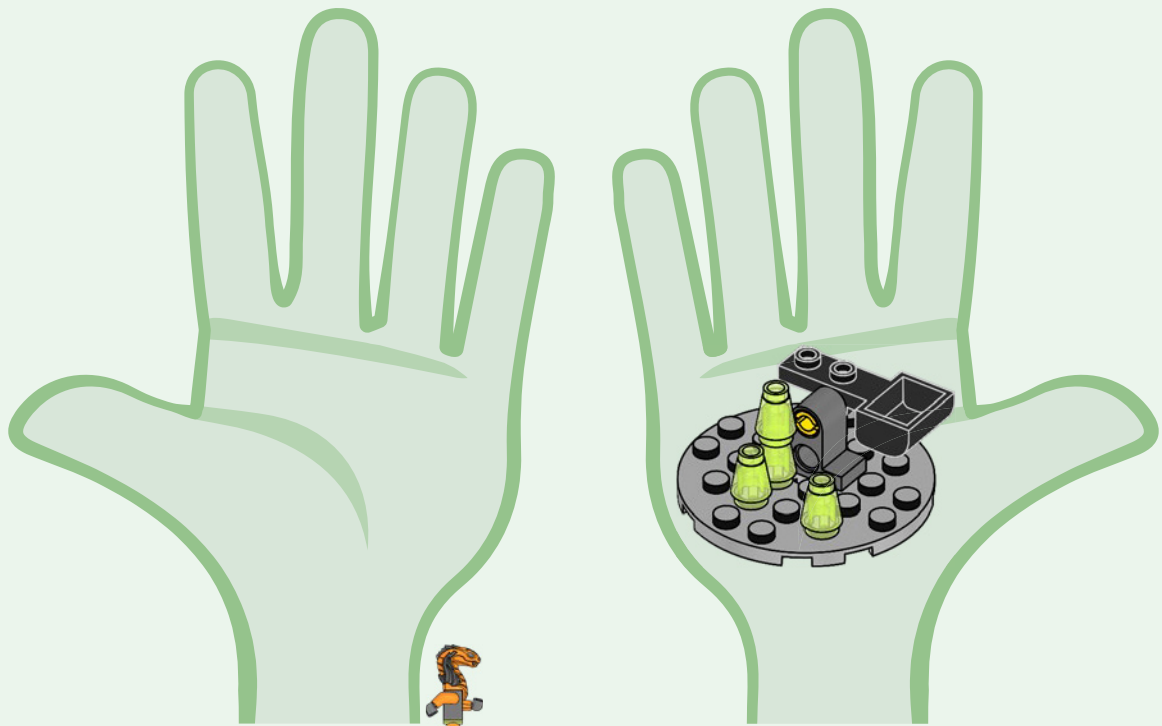



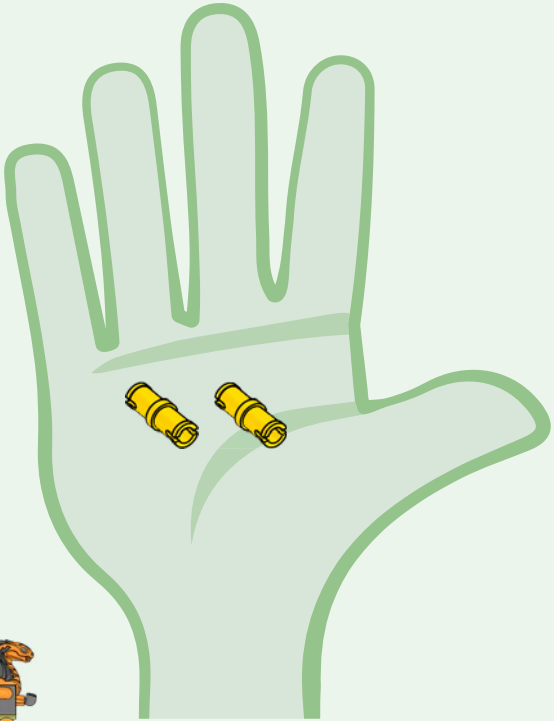
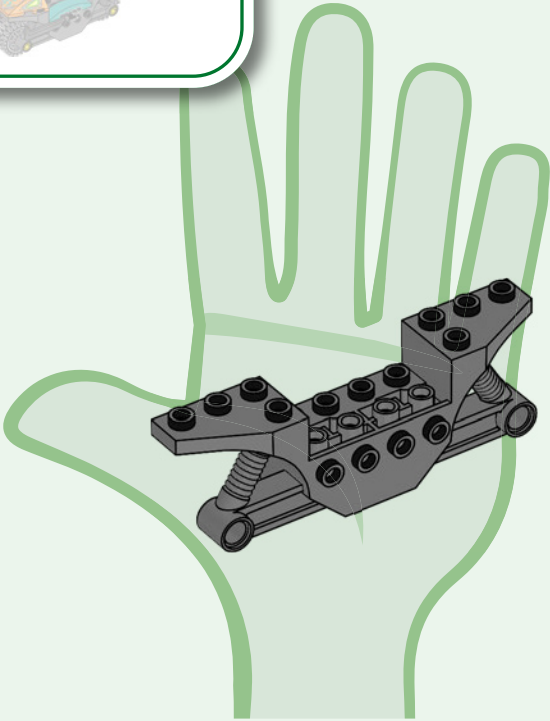
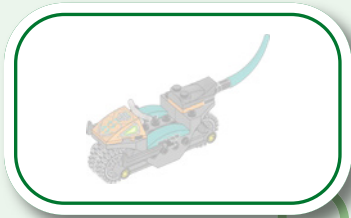

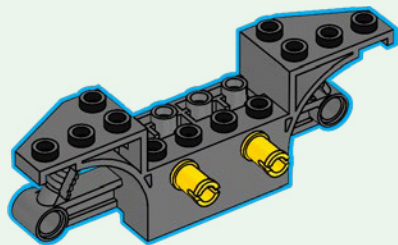

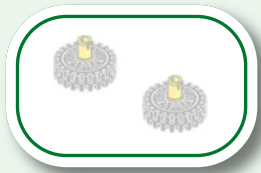

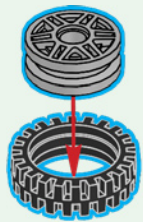

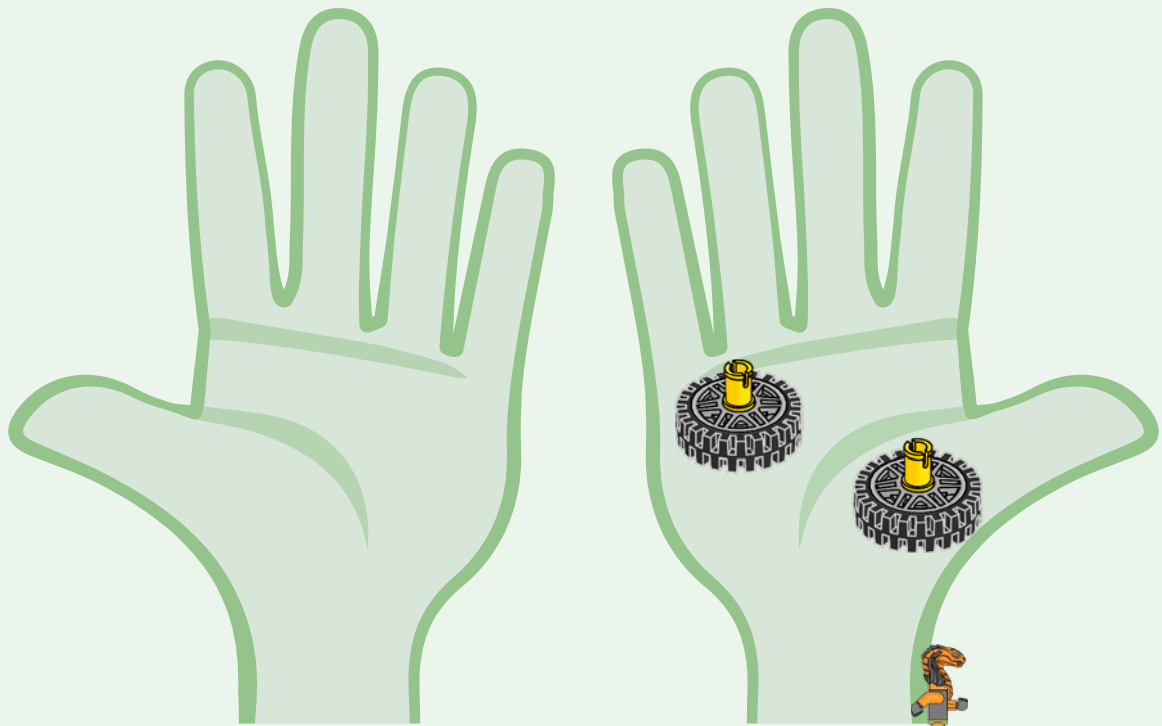

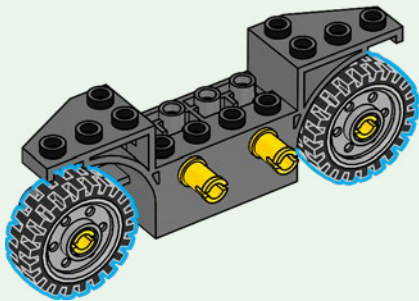

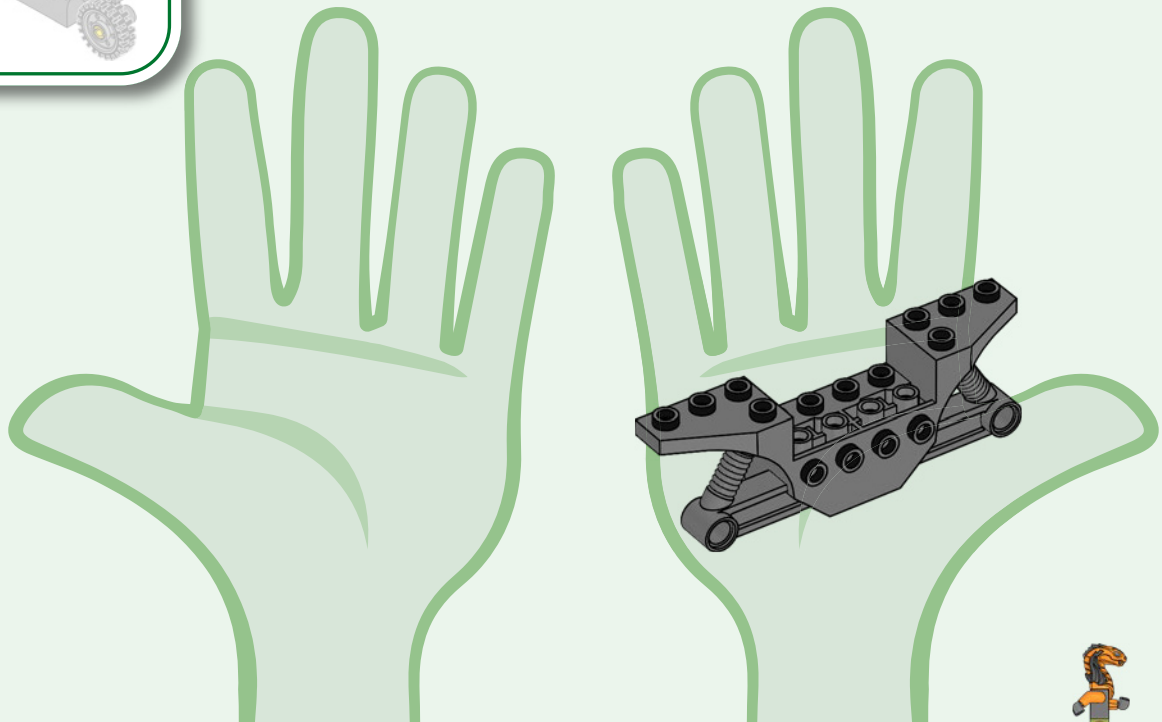
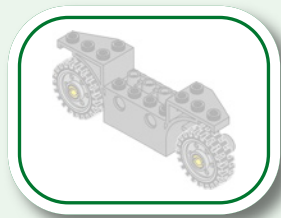

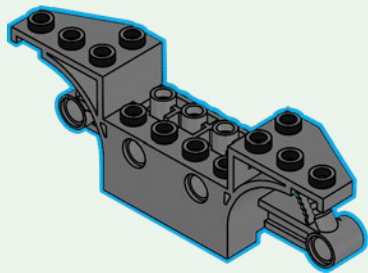

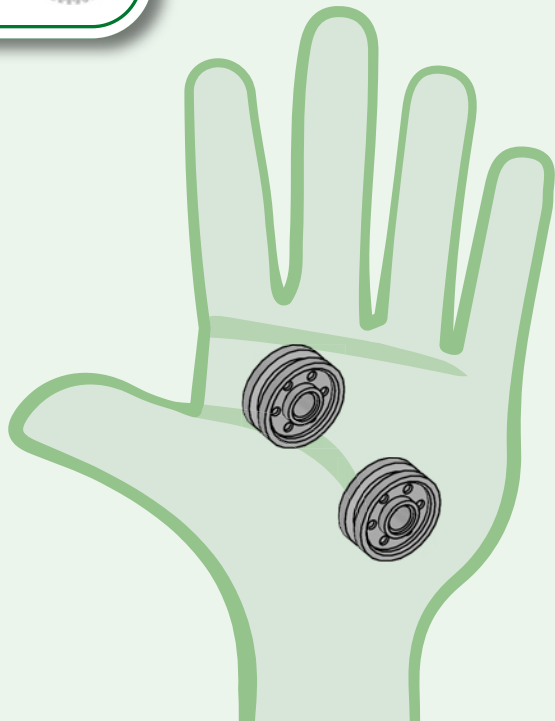

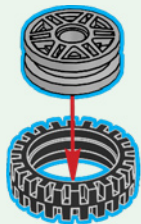

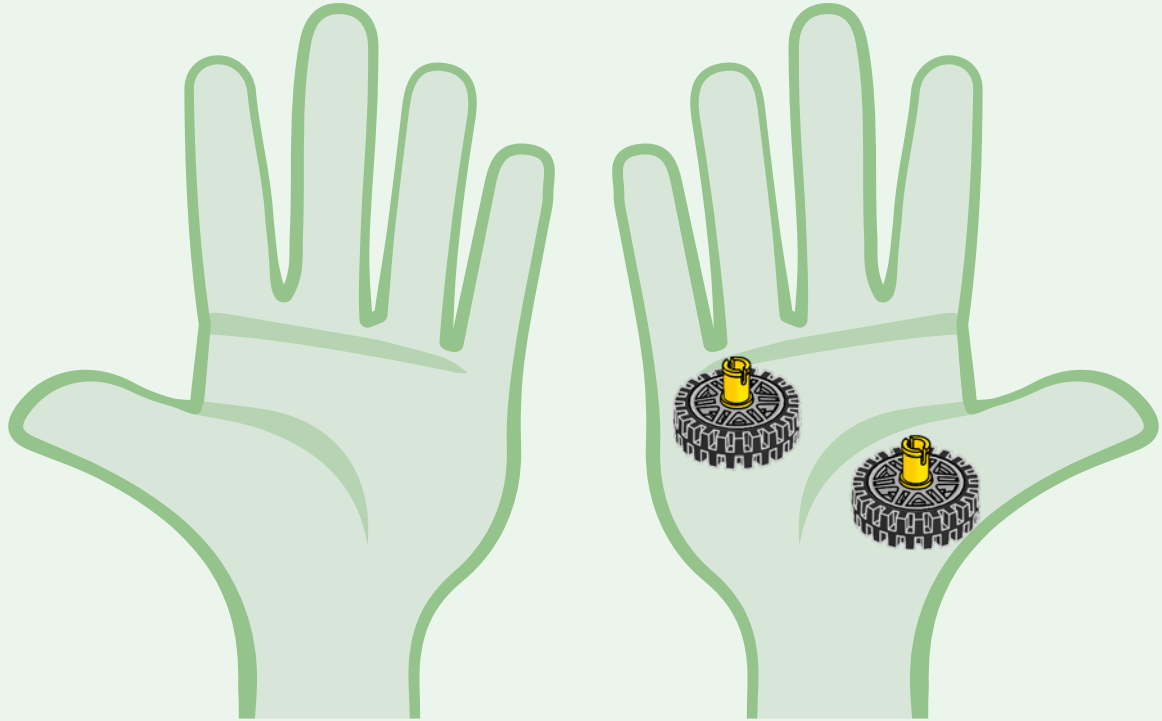

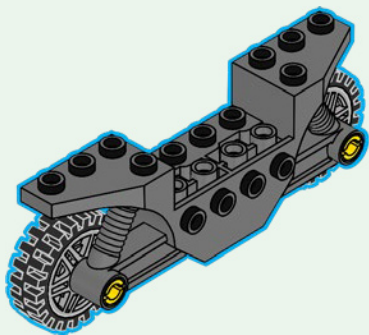

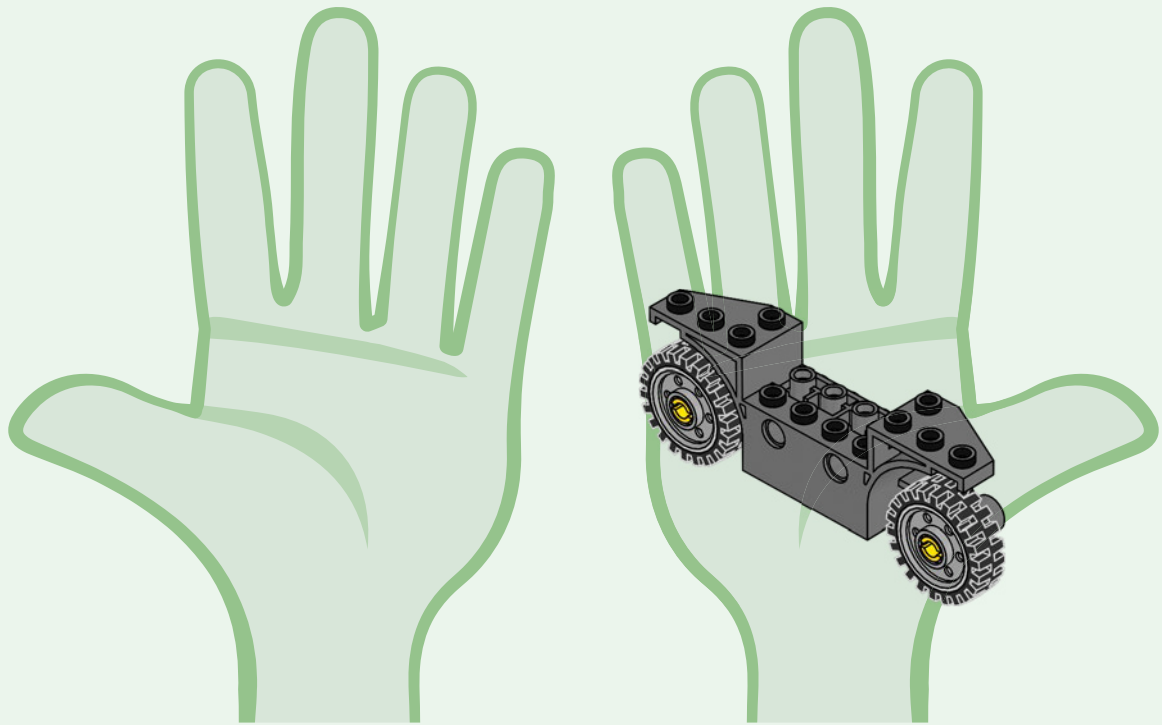

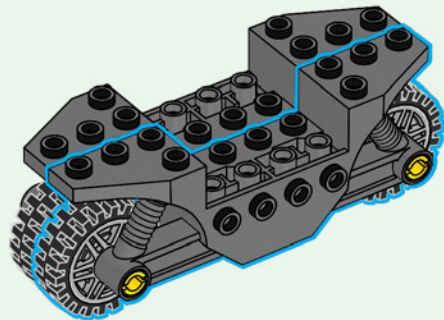

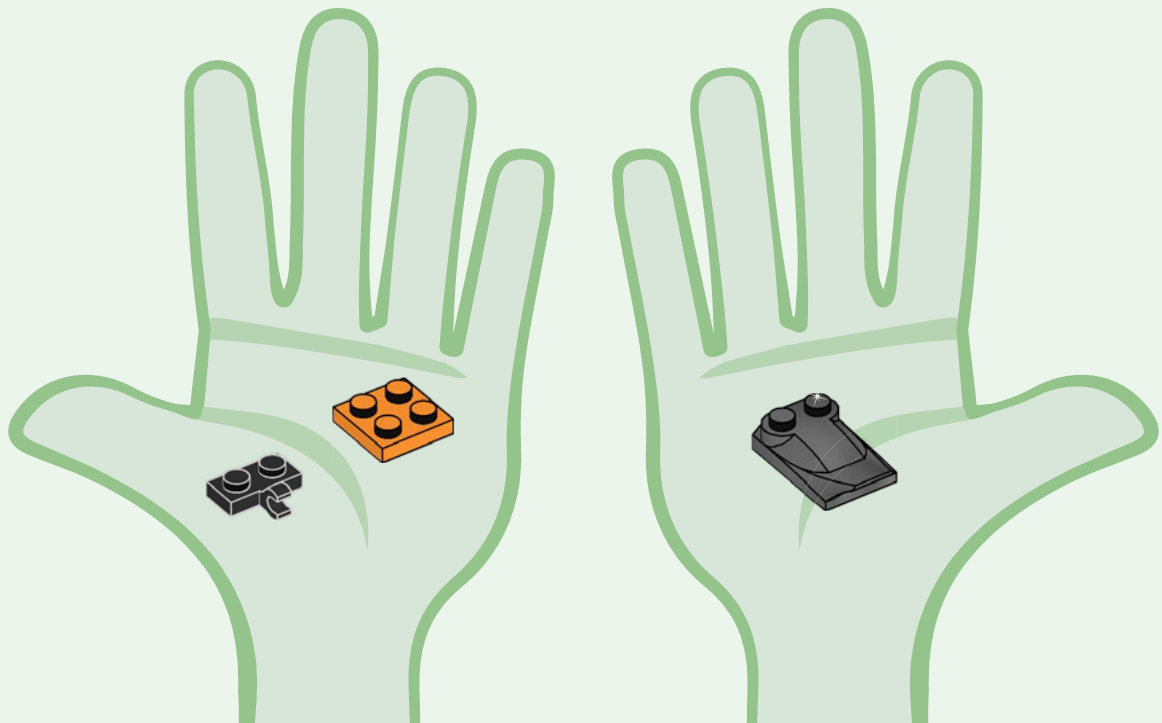

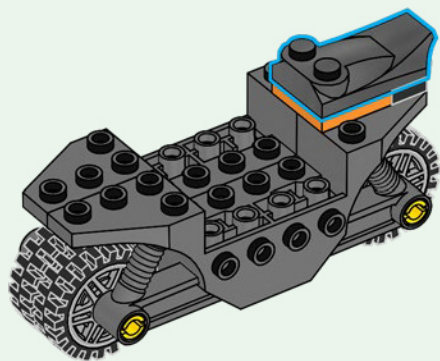
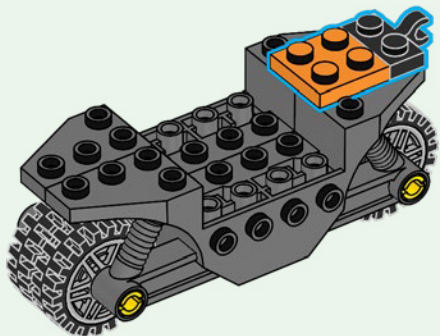

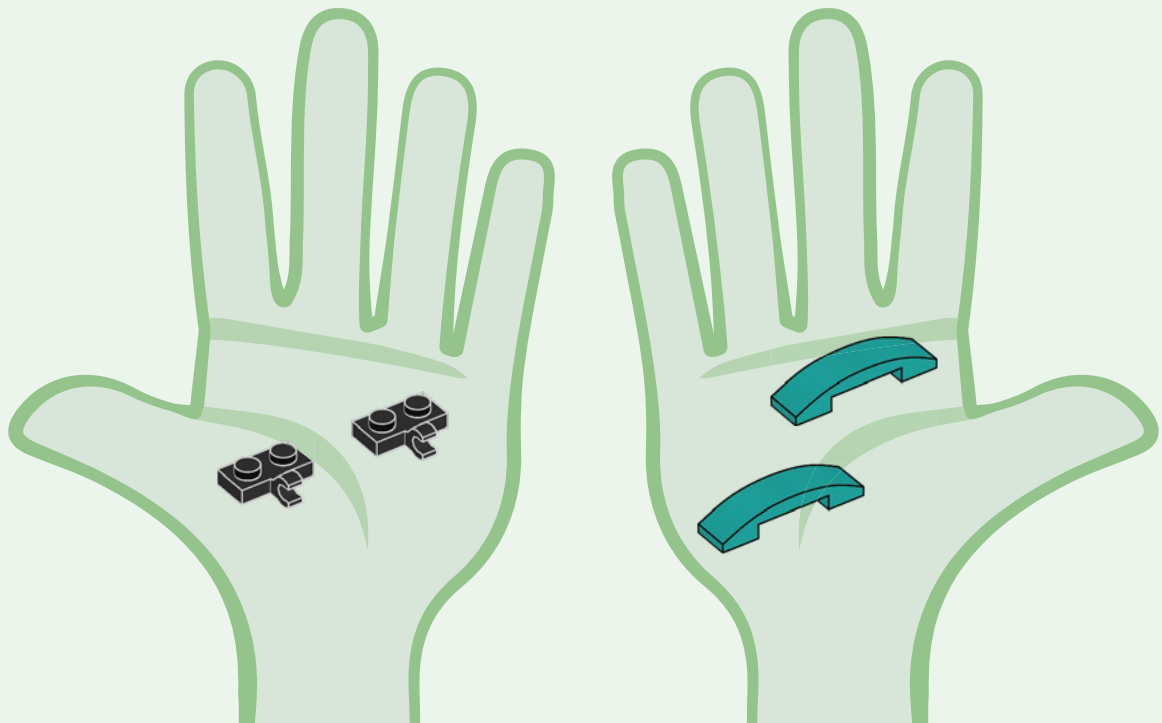

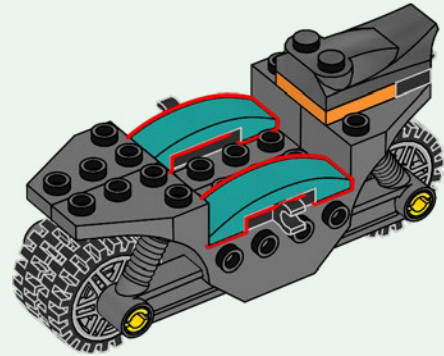
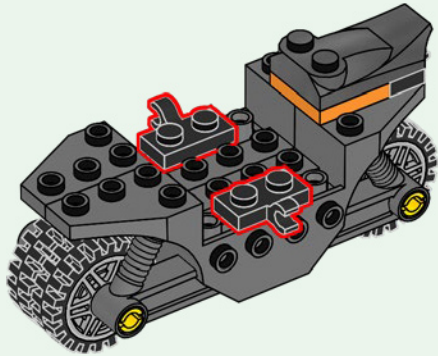

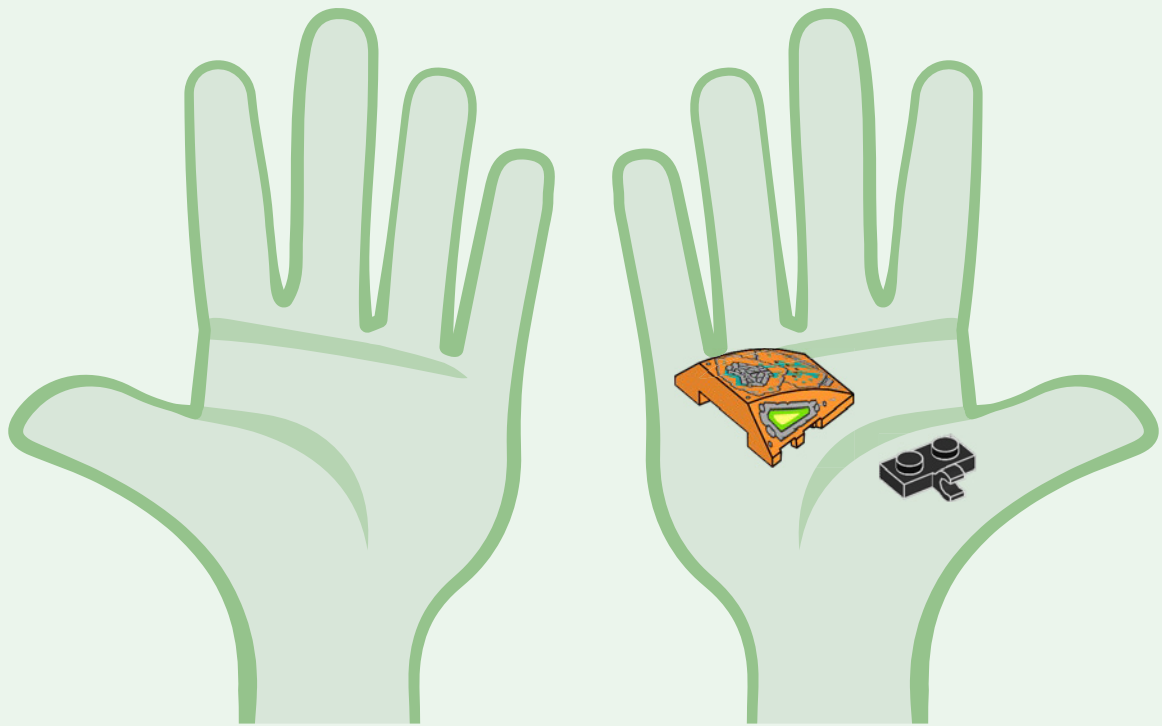

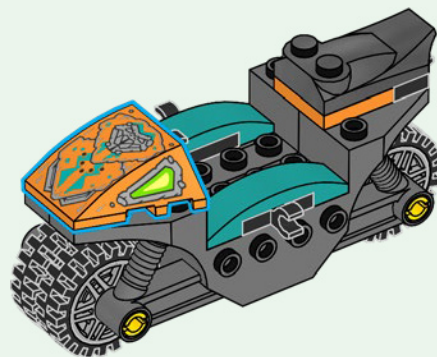
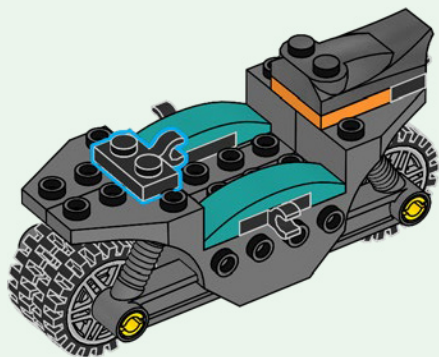

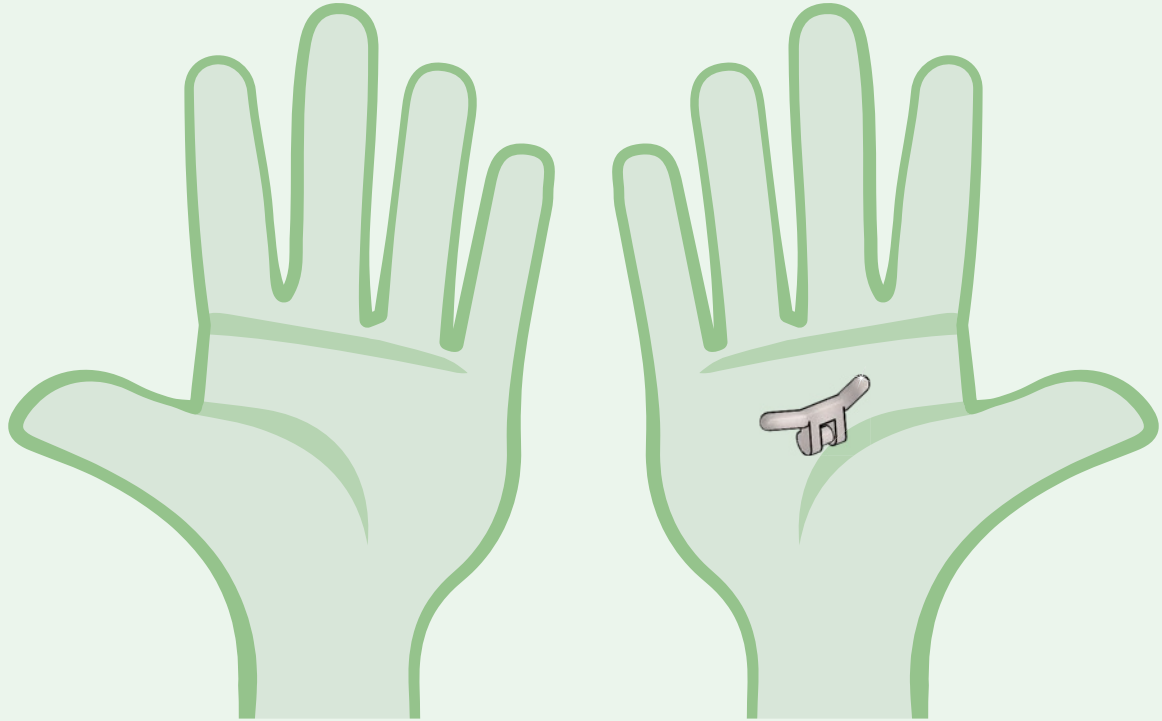

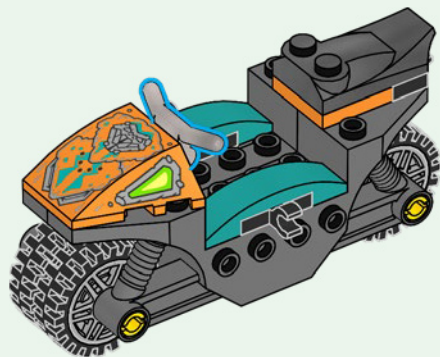

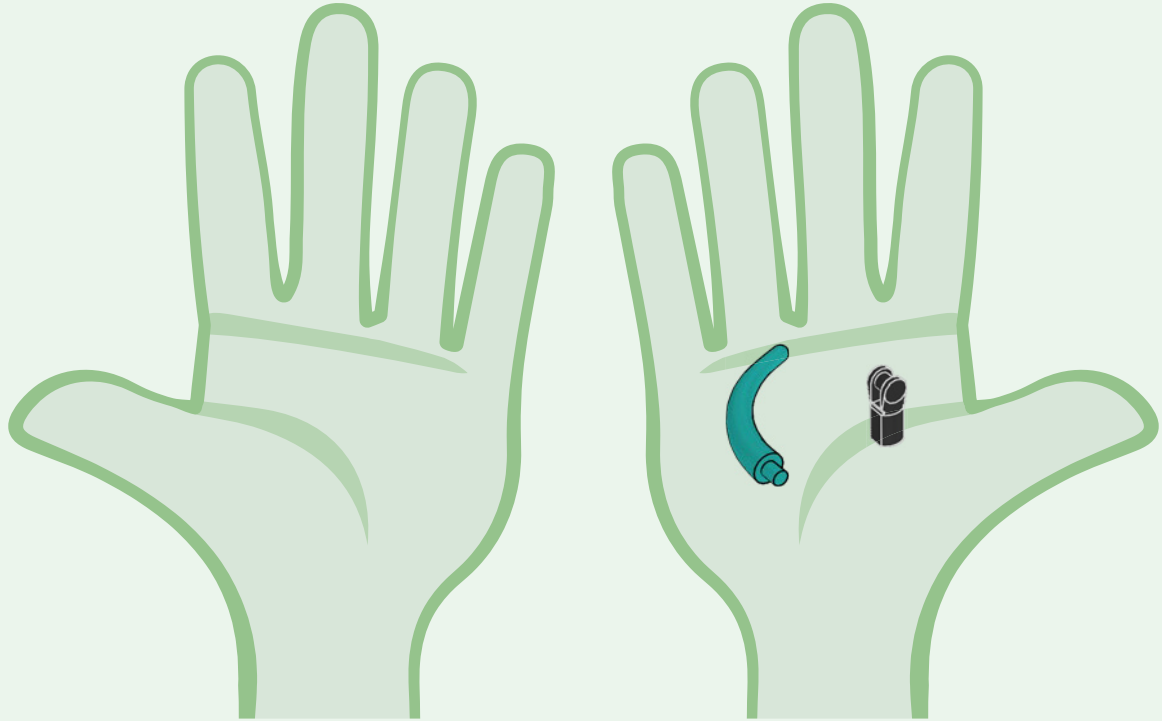

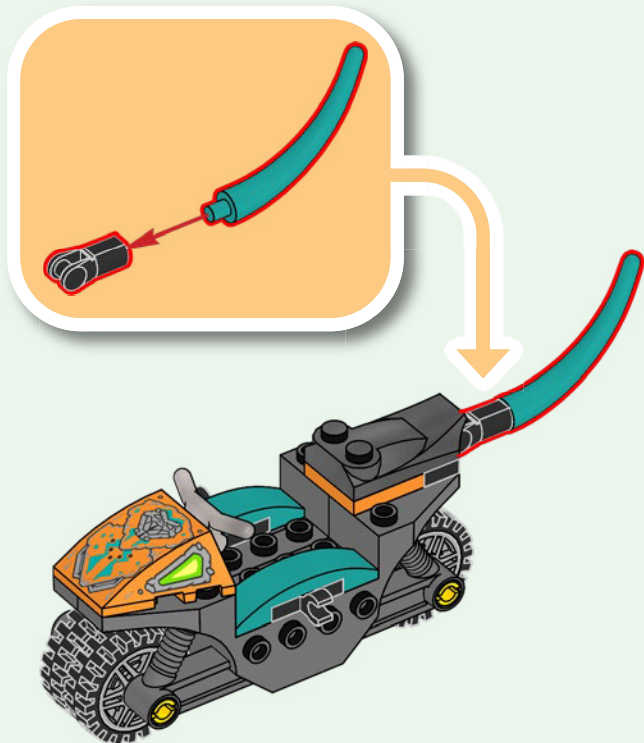

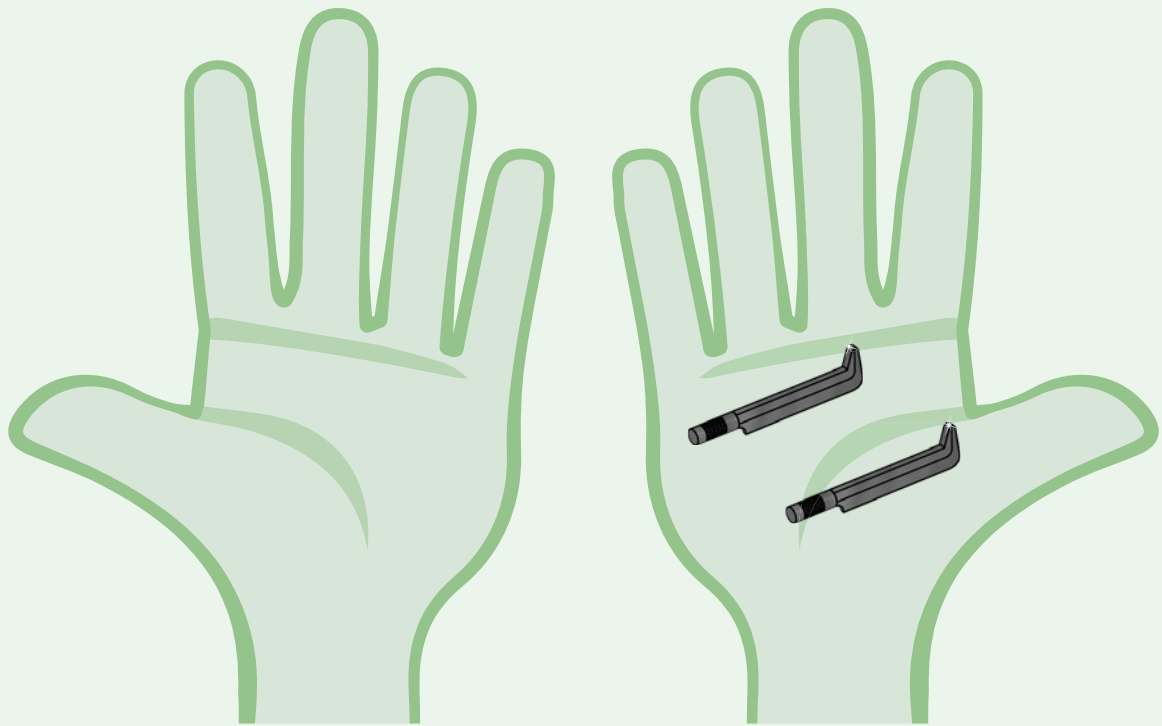

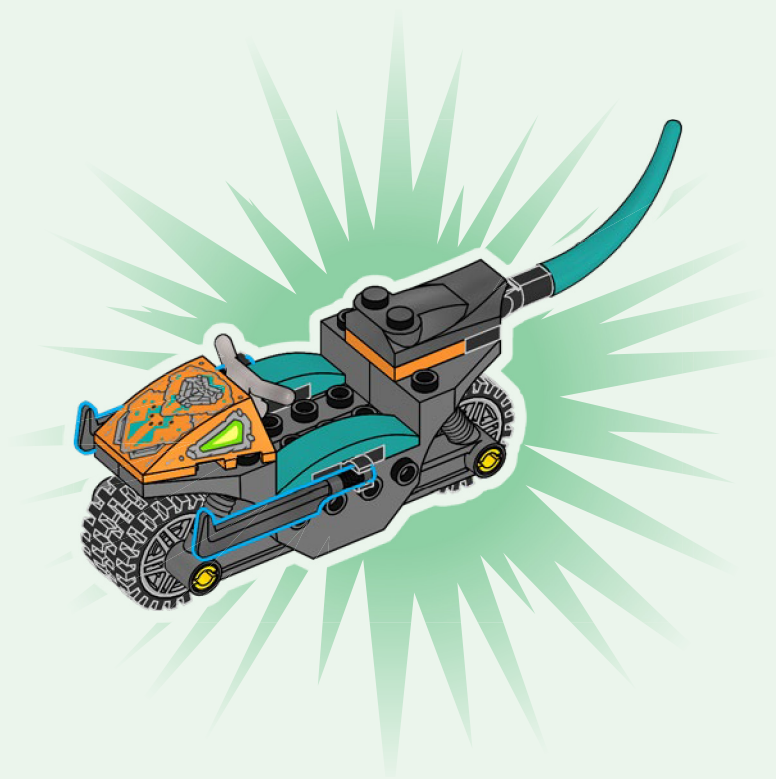

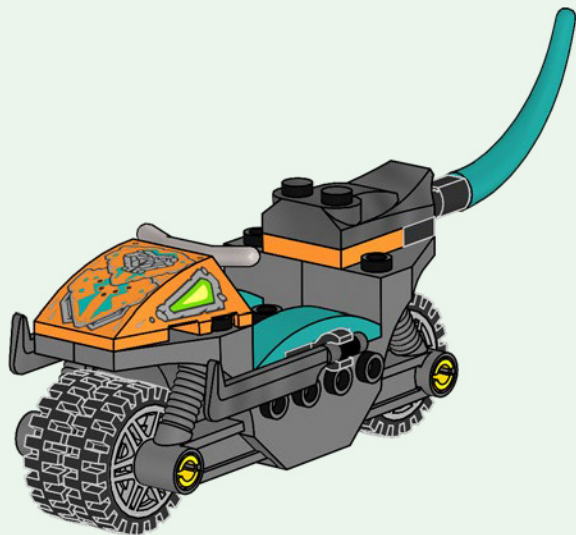





Rebuild
the
world™



LEGO, the LEGO logo and NINJAGO are trademarks of the LEGO Group.
©2022 The LEGO Group. 6415227



NINJAGO

71759



4





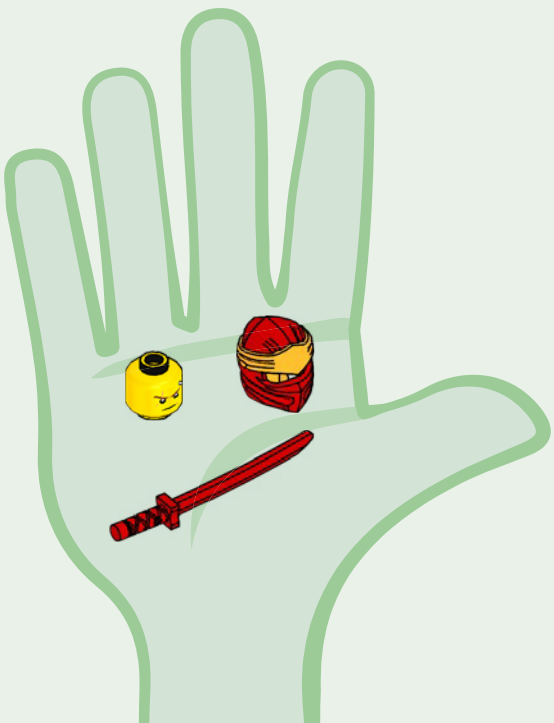
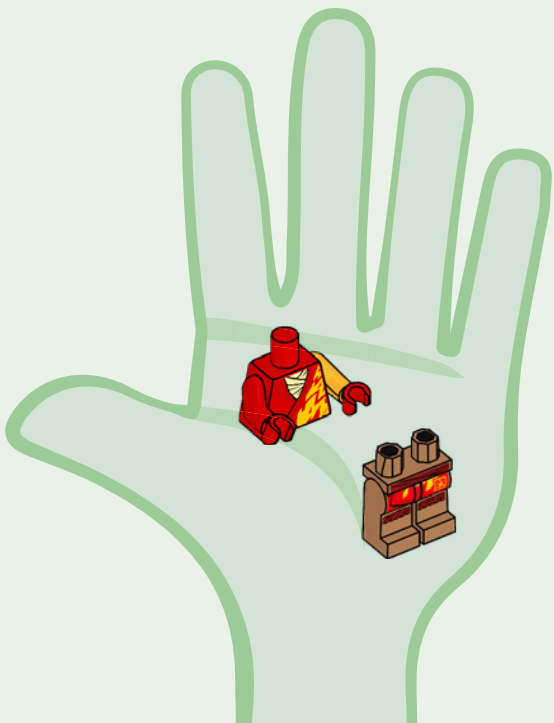

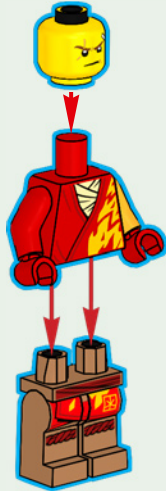

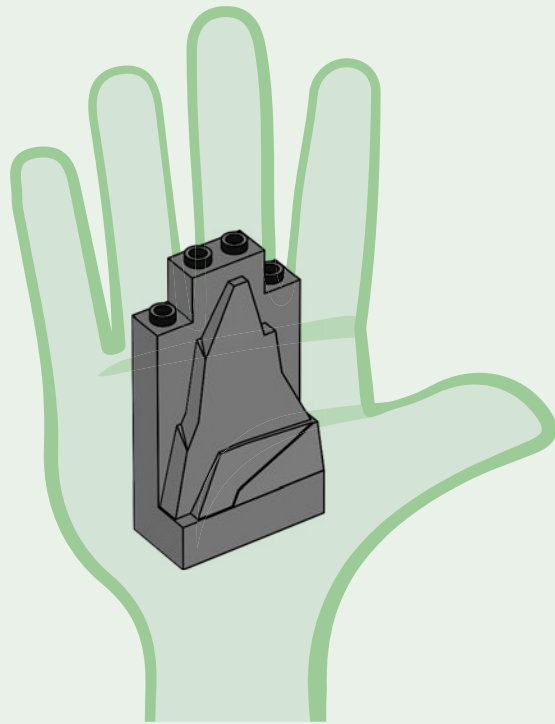
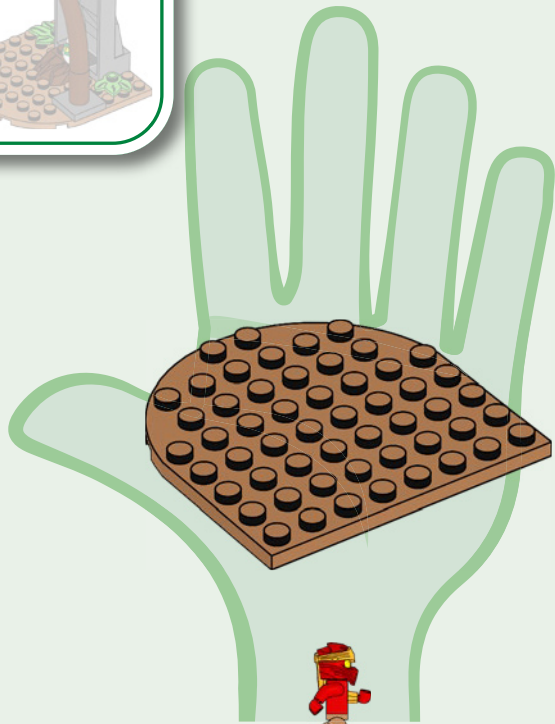

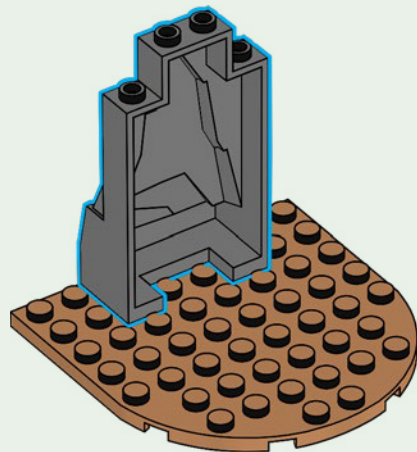
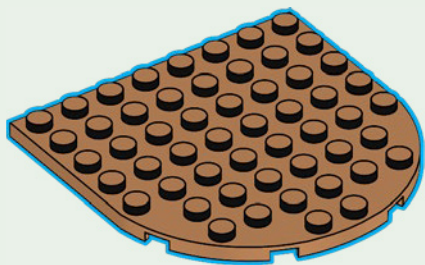

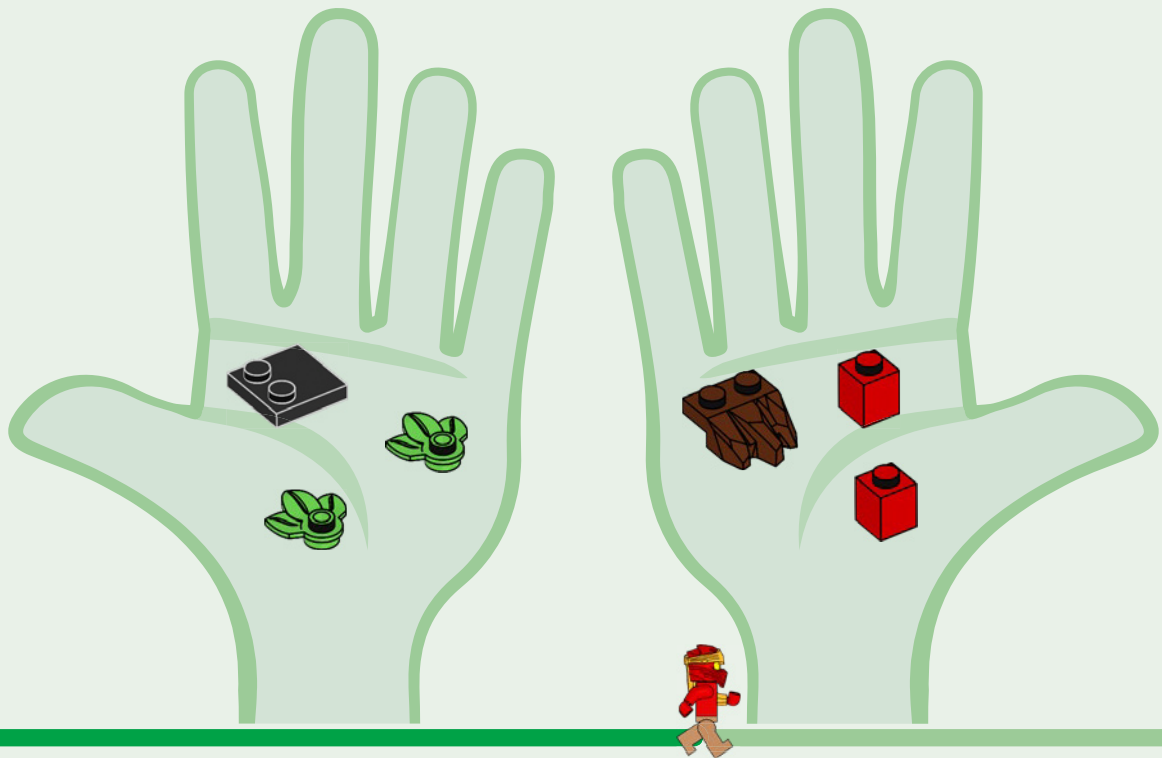

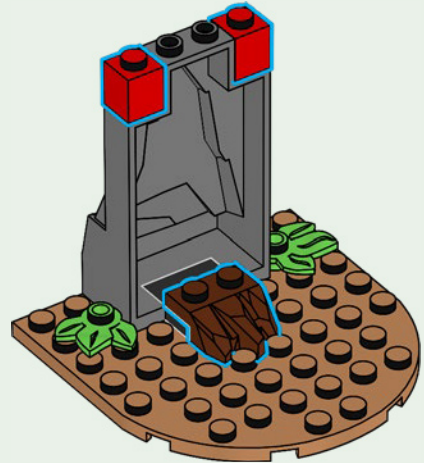
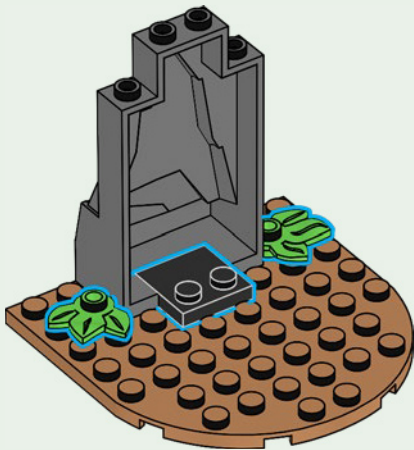

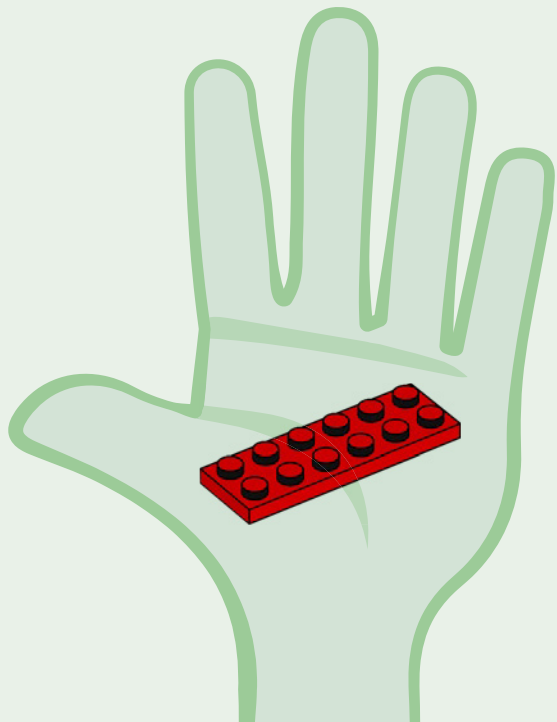

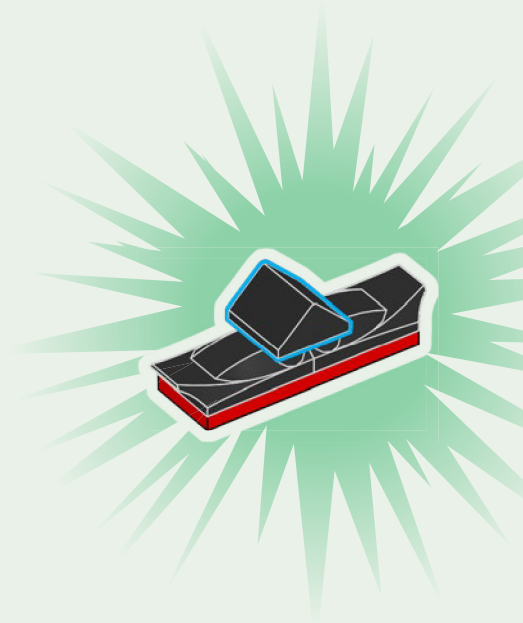
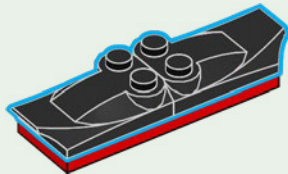
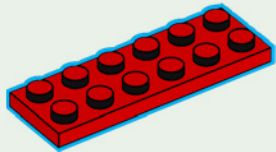

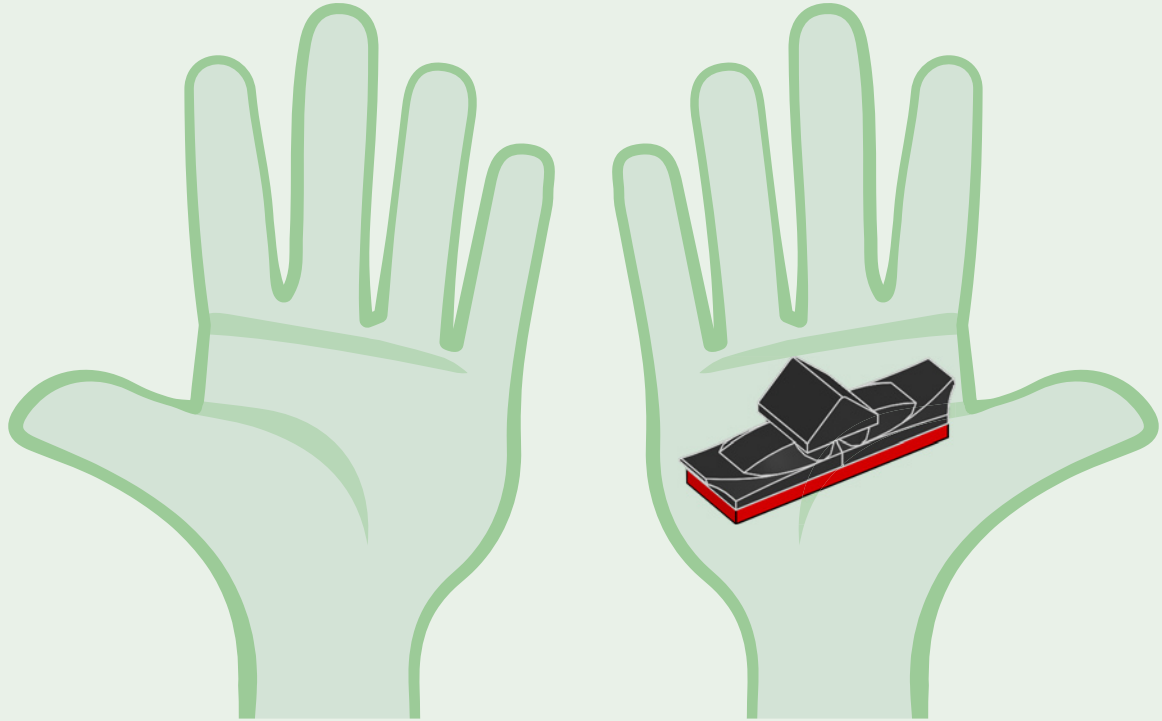



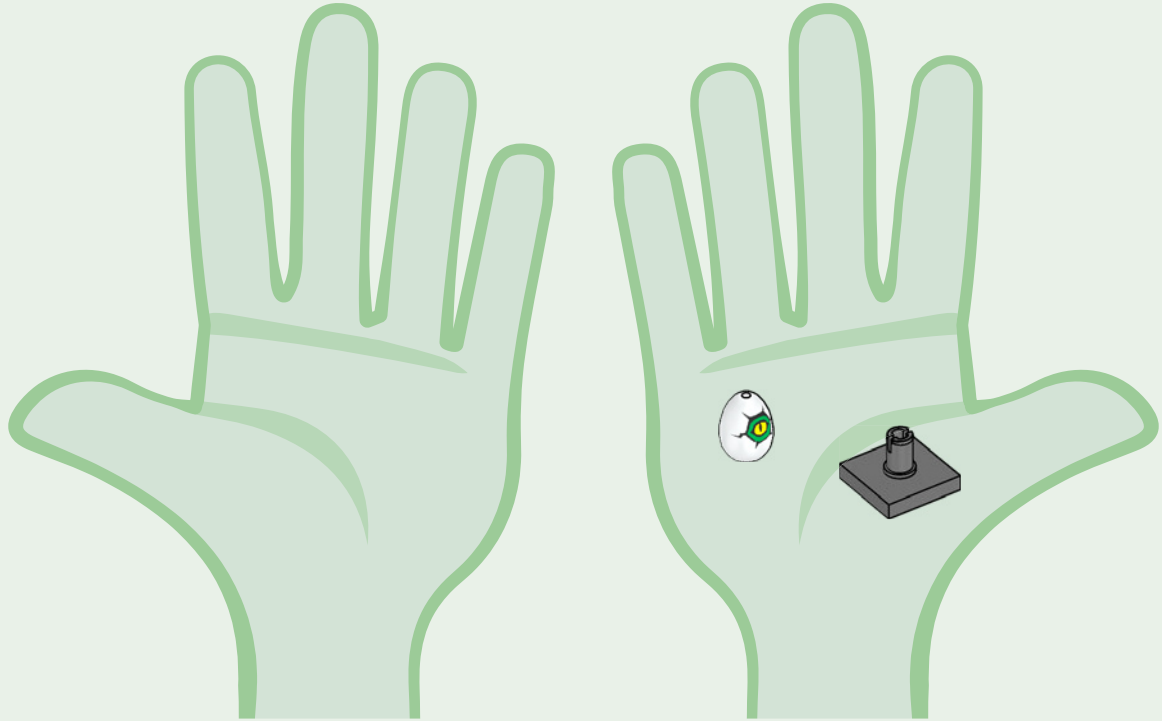

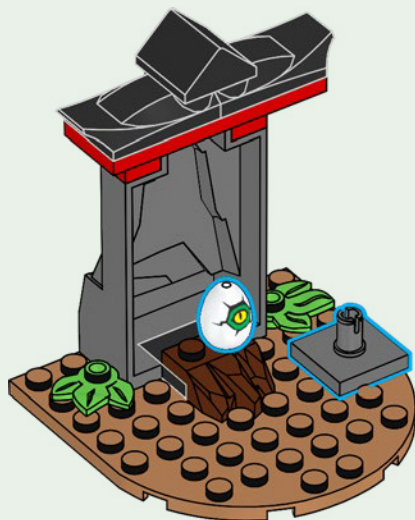

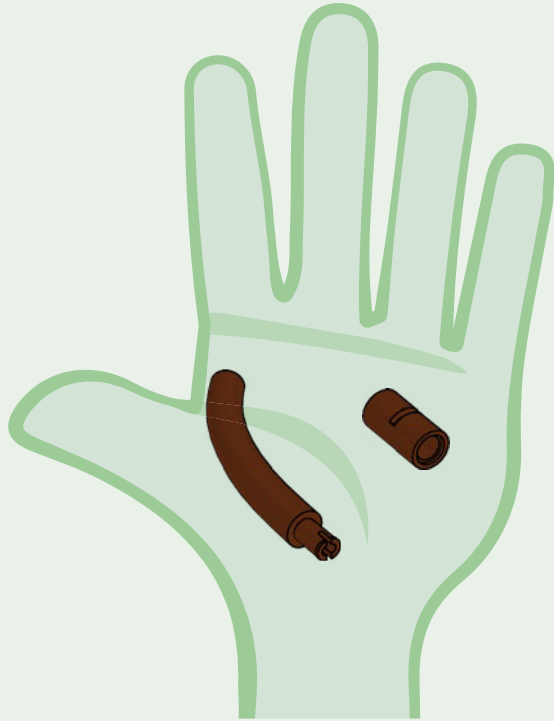

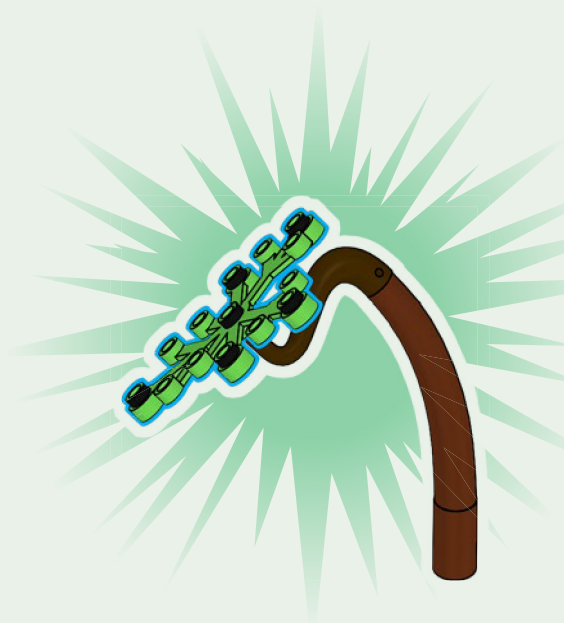
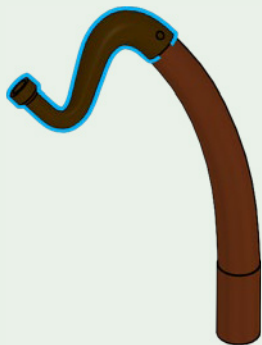
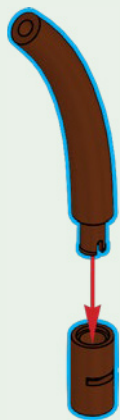

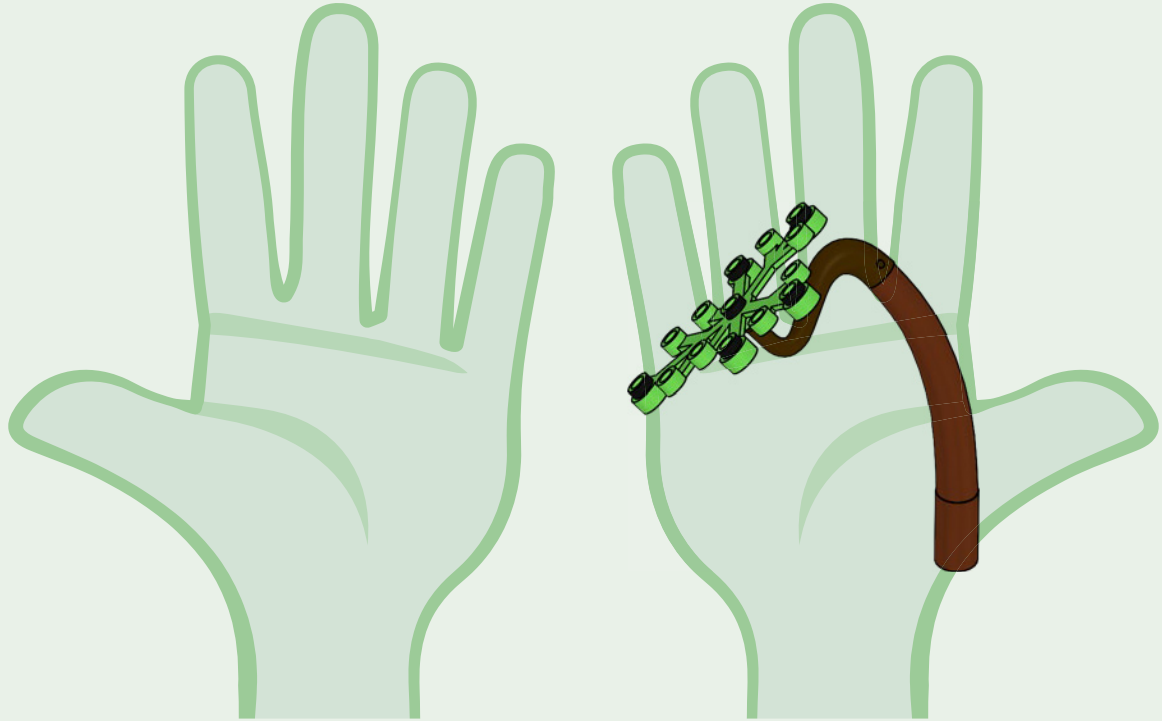

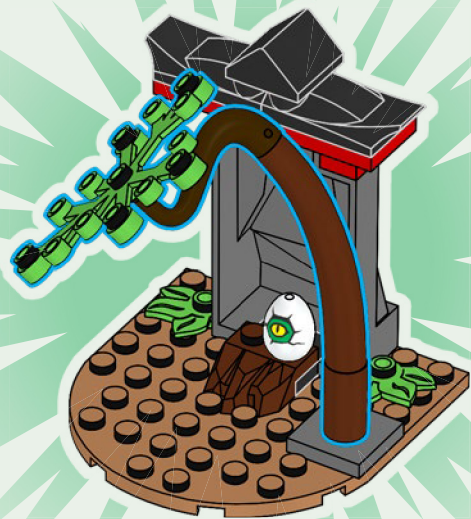







1x
6343846



1x
6235083



1x
6330903

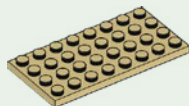

2x
4509897



2x
300521



1x
6372491



2x
6173126



3x
6132541

22



4x
6061711



1x
6372757



1x
6336922



1x
6288064



2x
6309044



5x
614321



3x
302321



1x
6288050



1x
6208752



1x
6287833



1x
6253828



1x
379521



7x
6331822



1x
300324



1x
6190411



1x
6253840



1x
6321194



4x
6313116



2x
6310268



1x
6192346



3x
4163373



1x
6061032



2x
6279875



4x
4541455



10x
4285883



1x
6225386



1x
6324143



4x
6182261



2x
6266964



2x
6370248



1x
4159007



1x
6385348



2x
6249299



1x
6270178



2x
6173132



2x
6338135



1x
6251403



2x
6326087



1x
6280388



1x
6043656



4x
6044729



1x
6105964



1x
6015349



1x
6368491



1x
4210763



3x
6313189



1x
6365695

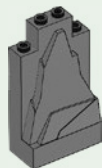

1x
4513326



2x
6172134



2x
4211061

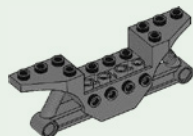

2x
6356277



1x
6287963



1x
6096099



2x
6378109



4x
6337628



1x
6368483



1x
6167741



1x
6171727



2x
6270135



1x
4611883



1x
6380065



2x
6371772



1x
6383973



1x
6167034



3x
6264145



1x
6158405



2x
6387610

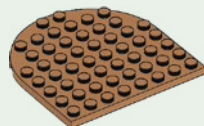

3x
6301315

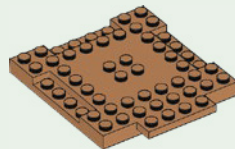

1x
6174193

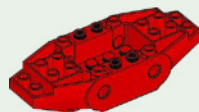

1x
6387611



2x
6366134



2x
6387613



1x
6385398



1x
6264121



2x
6341751



2x
6036851



2x
6144149



3x
6151663

Customer Service
 Kundenservice
 Service Client
 Assistenza clienti
 Atención al cliente
 Serviço de Apoio ao Consumidor
 Ügyfélszolgálat
 Klientu apkalpošanas dienests
 Serviciul pentru client
 客户服务
 客户サービス
 고객 서비스

LEGO.com/service



LEGO, the LEGO logo and NINJAGO are trademarks of the LEGO Group.
©2022 The LEGO Group. 6415229

Rebuild
the
world™

