



# duplo



**10947**

LEGO.com/DUPLO



# LEGO duplo



Age 1½ Age 2+





# CREATE A STORY

Create a story  
Denk dir eine Geschichte aus  
Créer une histoire  
Crea una storia  
Crea una historia  
Cria uma história  
Találj ki egy történetet  
Radi stāstu  
编创精彩故事



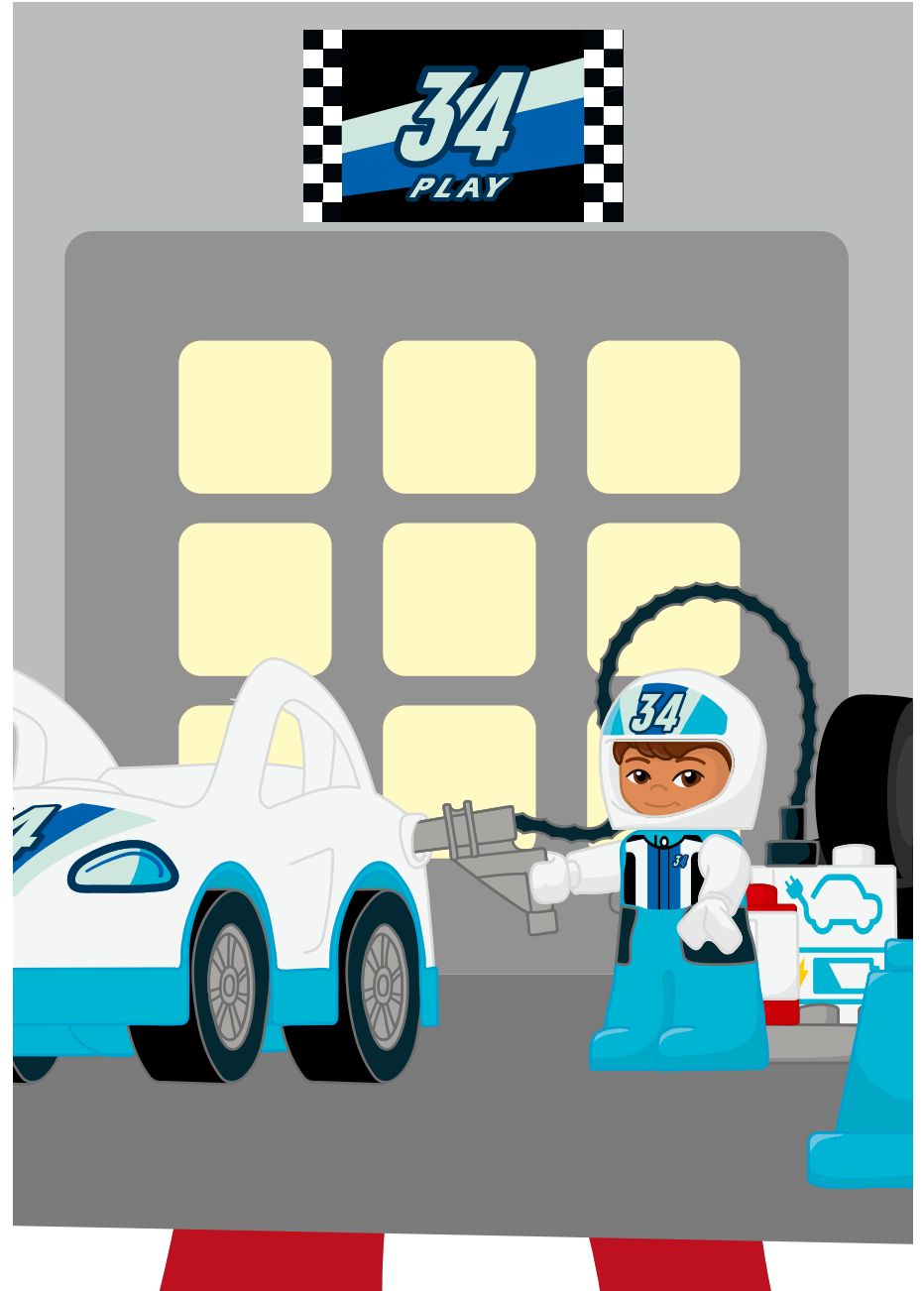



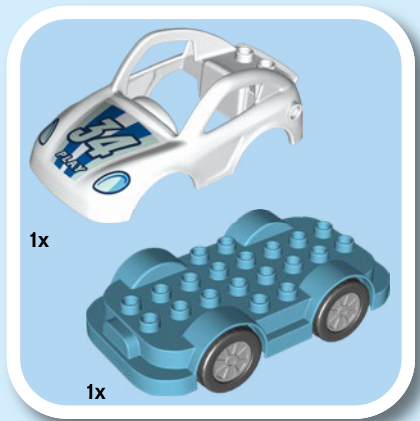

1

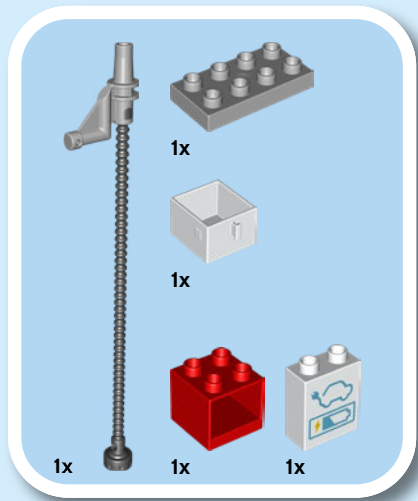
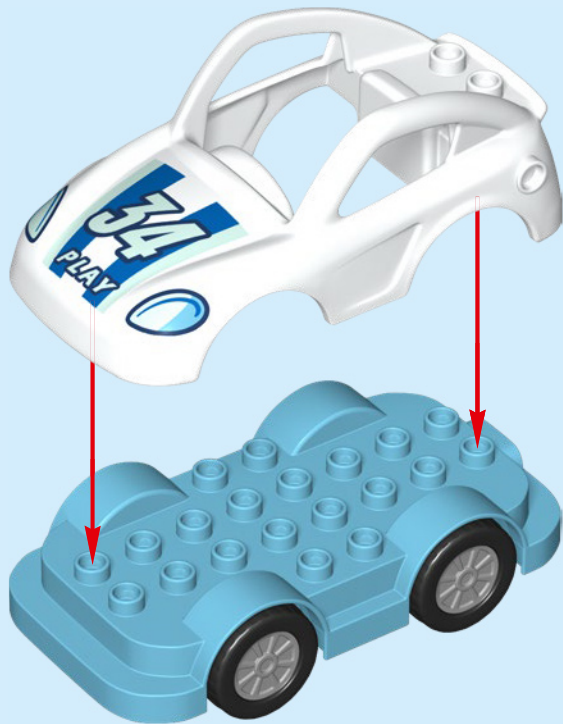

2

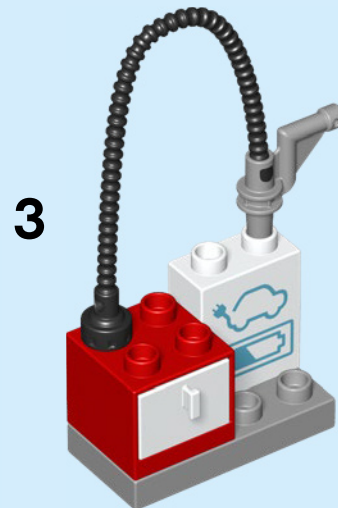
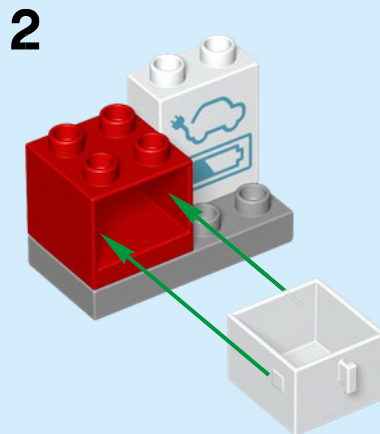
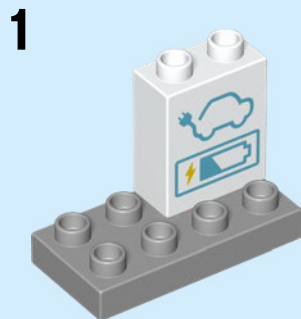

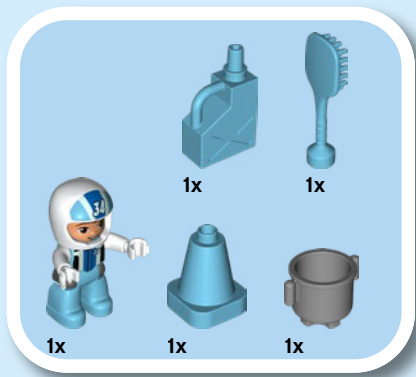

3









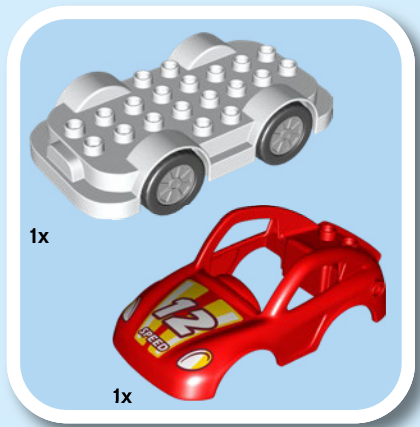

4



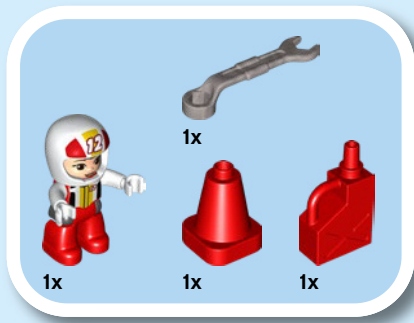

5





**win**  
 Go to [www.LEGO.com/productfeedback](http://www.LEGO.com/productfeedback)  
 and give us your short  
**feedback** about this  
 LEGO® DUPLO® set for a chance to win  
 a cool LEGO prize

Terms & Conditions apply

# LEGO.com/productfeedback

## GEWINNE

Erzähle uns auf [www.LEGO.com/productfeedback](http://www.LEGO.com/productfeedback)

etwas über die Erfahrungen, die du mit diesem LEGO® Set gemacht hast, und sichere dir die Chance auf einen coolen LEGO Preis!

Es gelten die Teilnahmebedingungen

## GAGNE

Rends-toi sur [www.LEGO.com/productfeedback](http://www.LEGO.com/productfeedback)

et donne-nous quelques commentaires sur ce produit LEGO® pour avoir une chance de gagner un prix LEGO !

Voir Conditions Générales

## GANAN

Visita [www.LEGO.com/productfeedback](http://www.LEGO.com/productfeedback)

y envíanos tu opinión acerca de este set LEGO®. ¡Participarás en el sorteo de un premio LEGO!

Términos y Condiciones aplicables

## 获取奖品

登录 [www.LEGO.com/productfeedback](http://www.LEGO.com/productfeedback)

给出关于此乐高®套装的简短反馈，就有机会获得炫酷乐高奖品

《条款及条件》适用

## 경품 당첨 기회

[www.LEGO.com/productfeedback](http://www.LEGO.com/productfeedback)

페이지로 이동하여 이 레고® 세트에 대한 간단한 피드백을 보내 주시고 멋진 레고 경품을 탈 수 있는 기회도 잡으십시오

약관 적용

## ЗАПОЛНИ АНКЕТУ И ПОЛУЧИ ПРИЗ

Перейди по ссылке [www.LEGO.com/productfeedback](http://www.LEGO.com/productfeedback)

ответь всего на несколько вопросов об этом наборе LEGO®, и у тебя появится шанс выиграть замечательный приз от компании LEGO.

Применяются Условия и правила участия

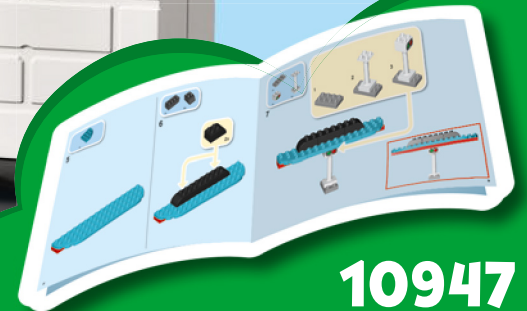

 duplo

The word "duplo" is written in a large, yellow, rounded font with a white outline and a red shadow. A small red rabbit character is perched on the letter 'p'.

**10947**  
LEGO.com/DUPLO

# EXPLORE THE DIGITAL UNIVERSE

ERKUNDE DAS DIGITALE UNIVERSUM/EXPLORER L'UNIVERS DIGITAL/  
ESPLORA L'UNIVERSO DIGITALE/EXPLORA EL UNIVERSO DIGITAL/  
EXPLORA O UNIVERSO DIGITAL/FEDEZD FEL A DIGITÁLIS UNIVERZUMOT/  
IZPĒTI DIGITĀLO PASAULI/  
探索数字世界



DUPLO° NURSERY RHYMES  
DUPLO° KINDERLIEDER  
COMPTINES POUR ENFANTS DUPLO°  
FILASTROCCHIE DUPLO°  
CANCIONES INFANTILES DUPLO°  
DUPLO° CANÇÕES INFANTIS  
DUPLO° GYERMEKDALOK  
DUPLO° BĒRNU SKAITĀMPANTI  
得宝°儿歌

Customer Service  
Kundenservice  
Service Consommateurs  
Servicio Al Consumidor  
LEGO.com/service or dial

: 00800 5346 5555  
: 1-800-422-5346



# CREATE A STORY

Create a story  
Denk dir eine Geschichte aus  
Créer une histoire  
Crea una storia  
Crea una historia  
Cria uma história  
Találj ki egy történetet  
Radi stāstu  
编创精彩故事









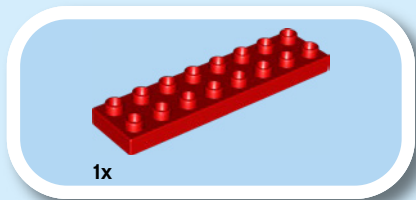

1x

1

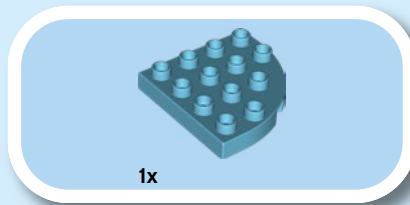
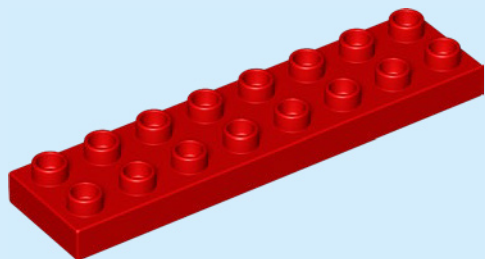

1x

2

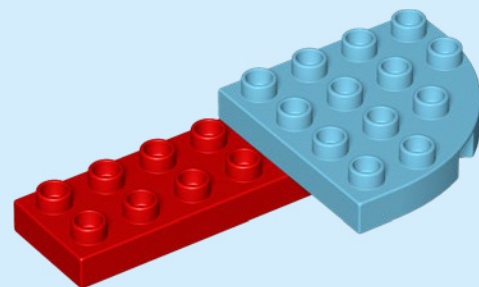

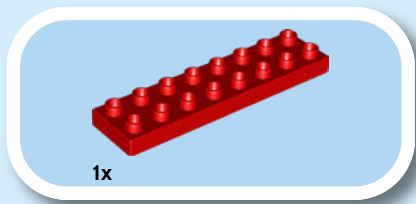

3

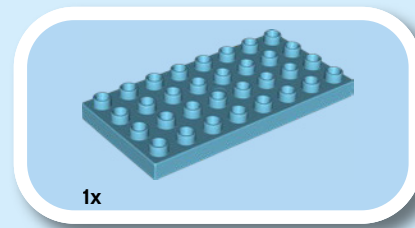
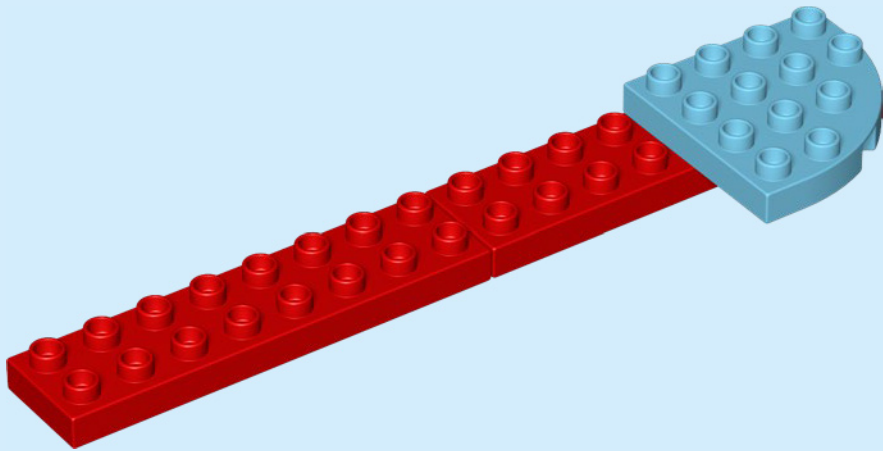

4

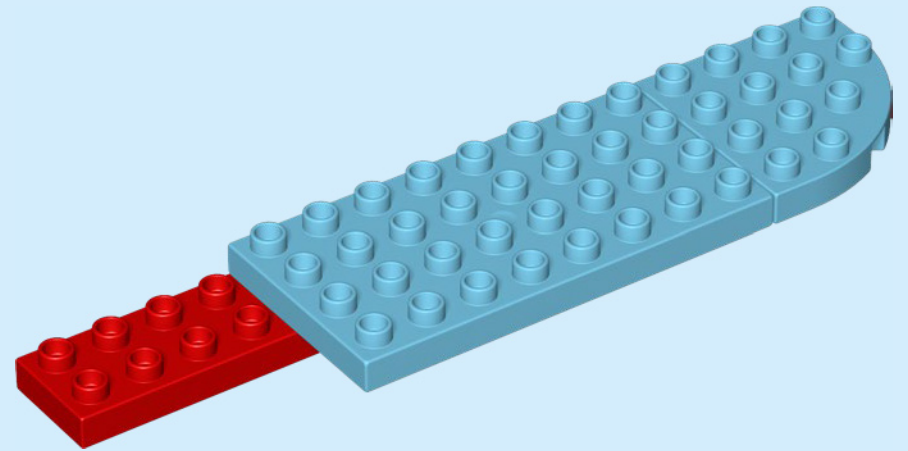

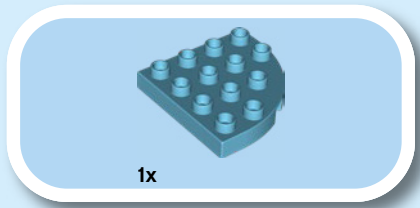

5

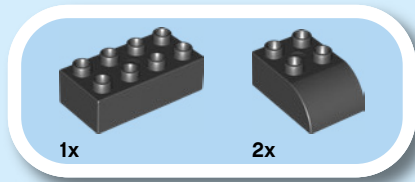
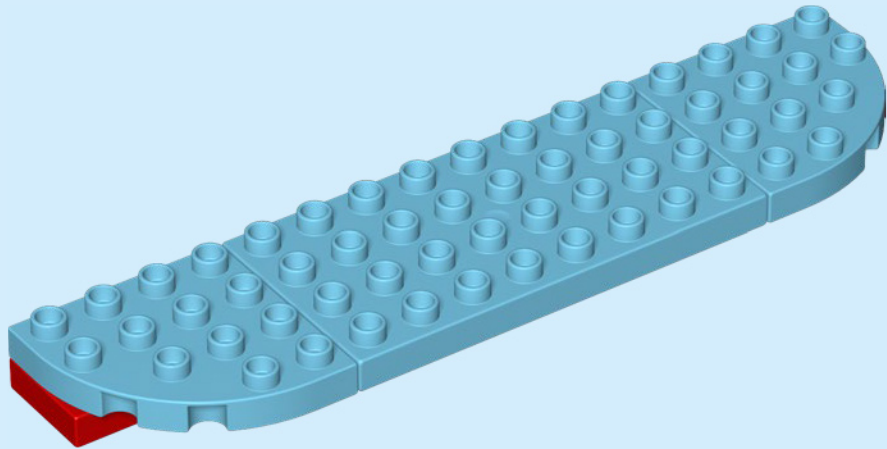

6

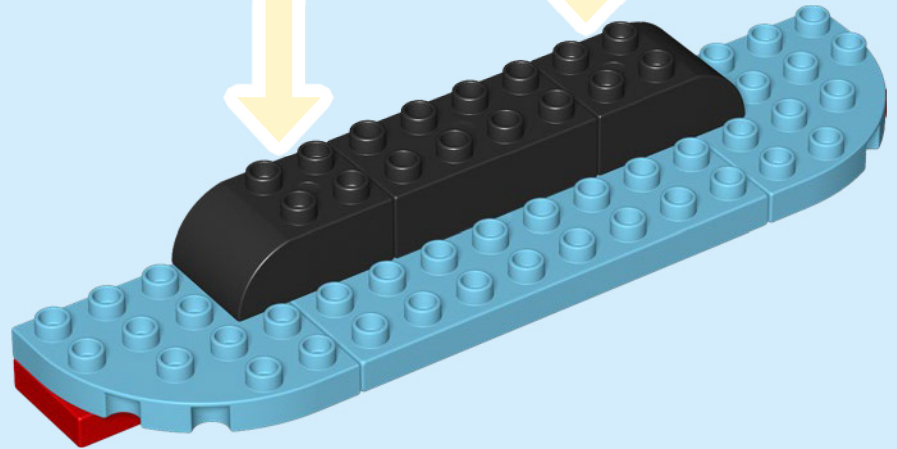
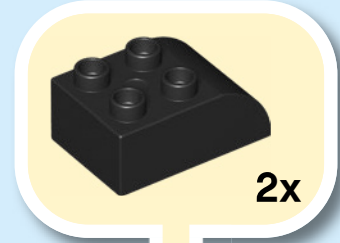

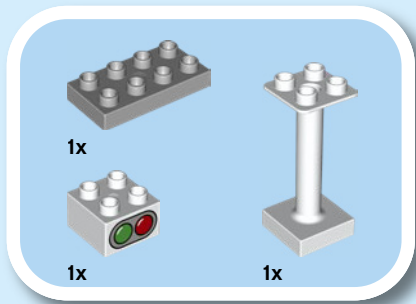

7

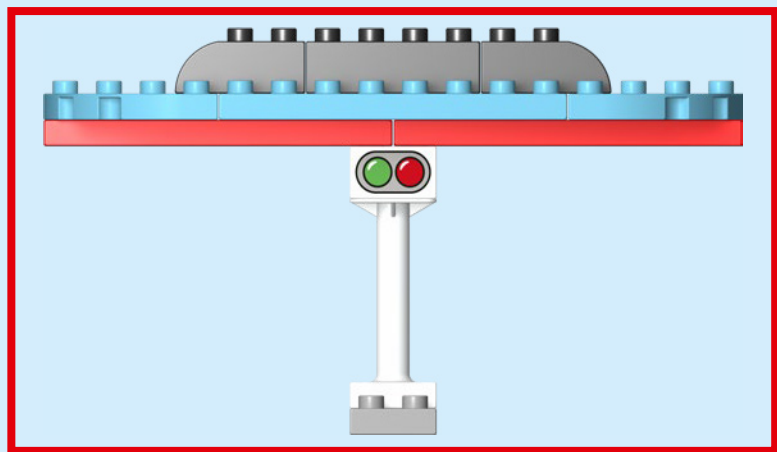
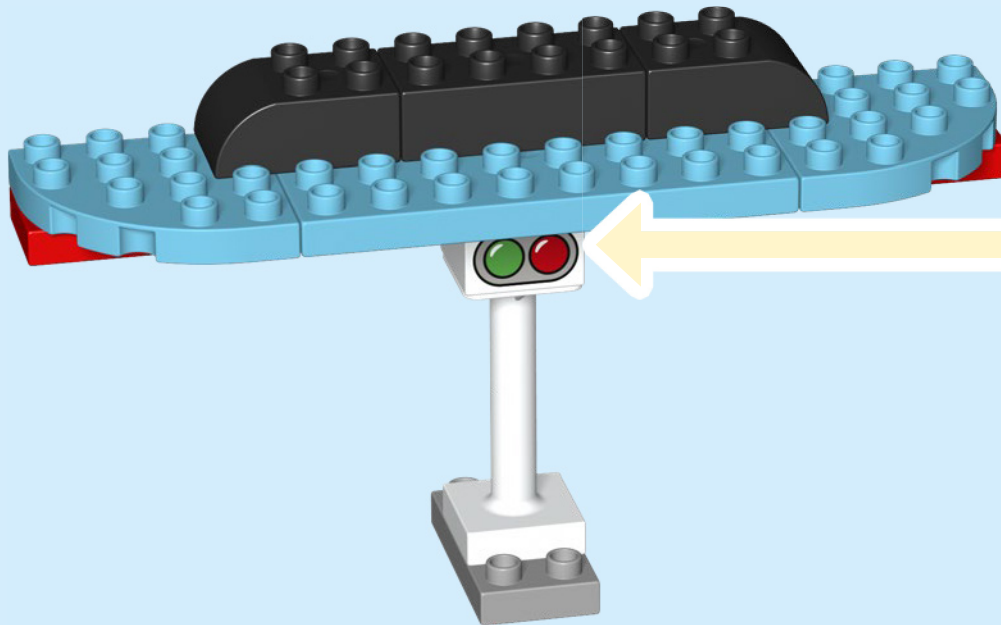
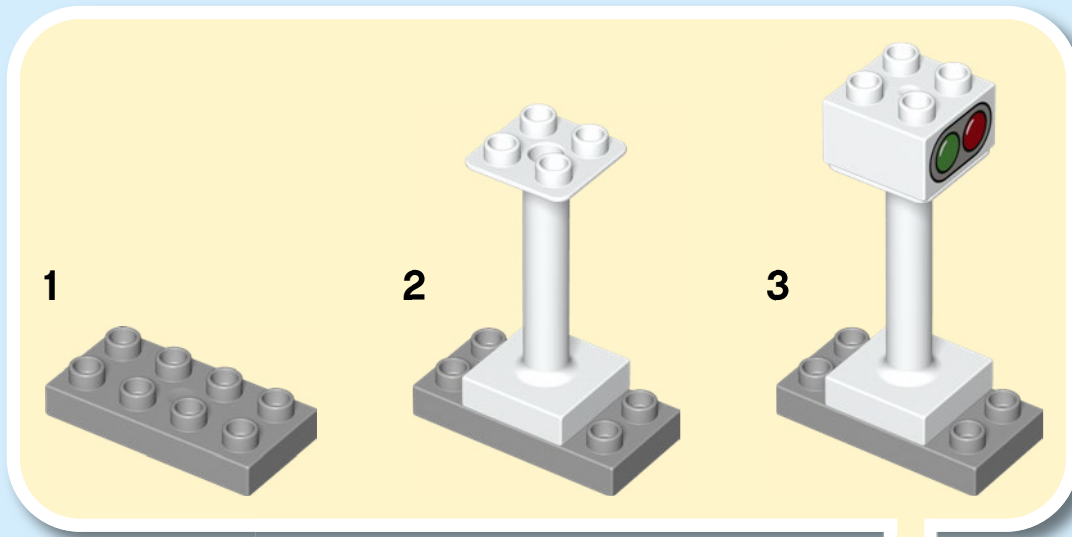

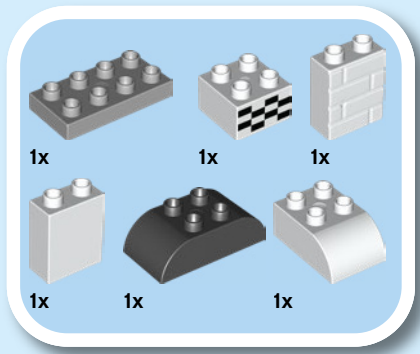

8

1

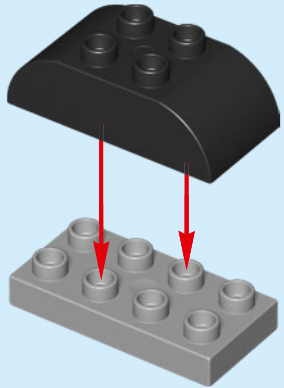

2



3

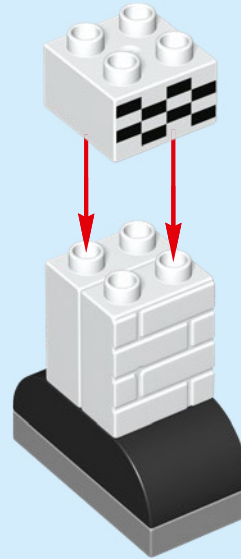

4



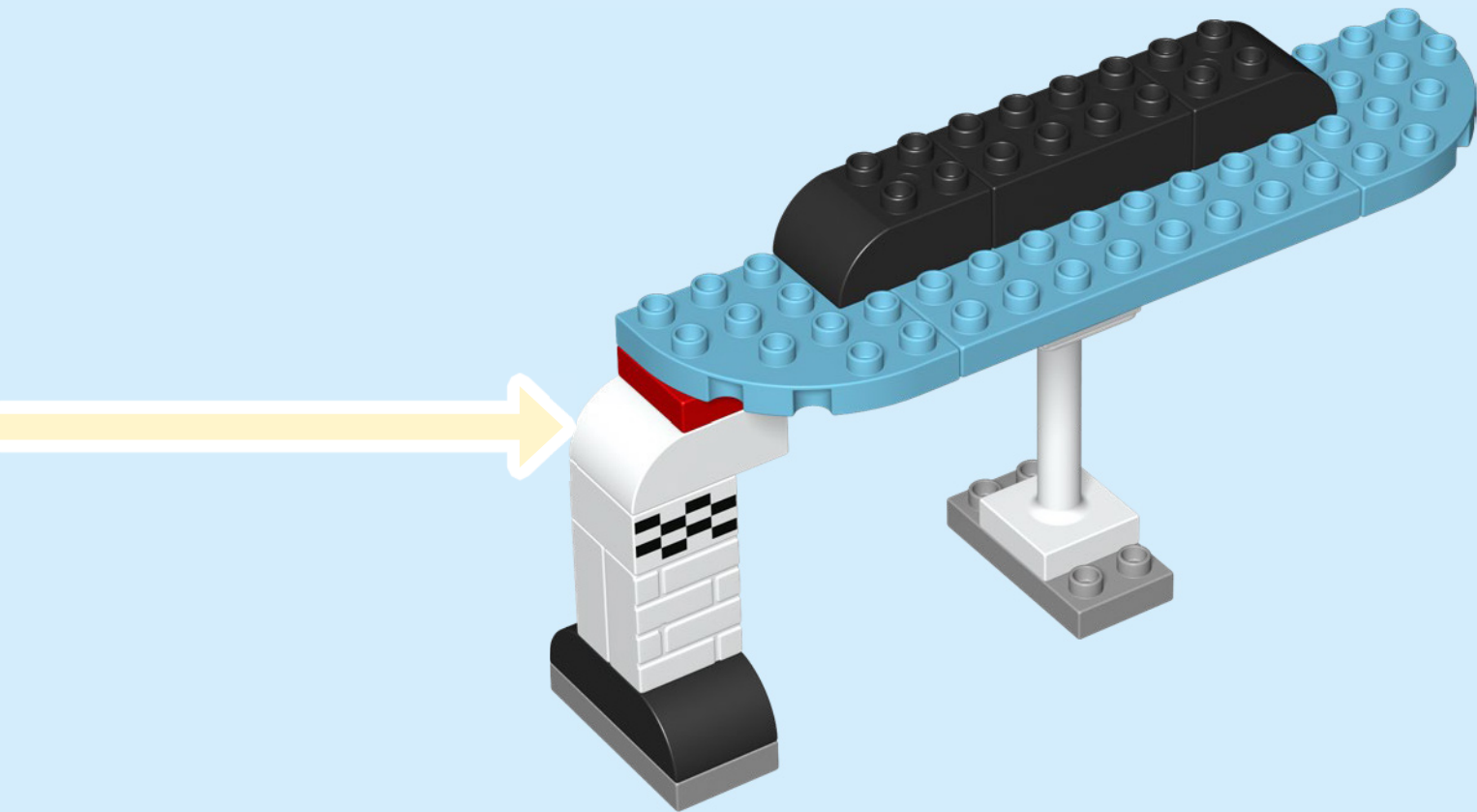

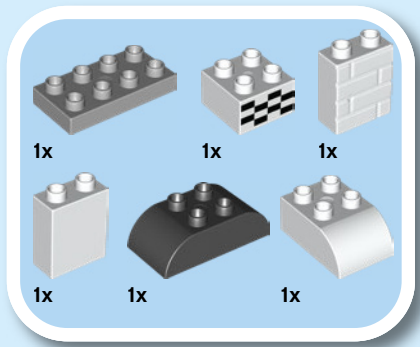

# 9

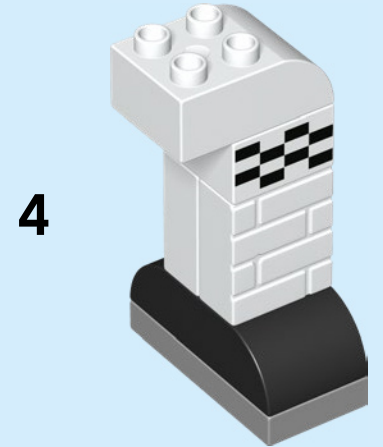
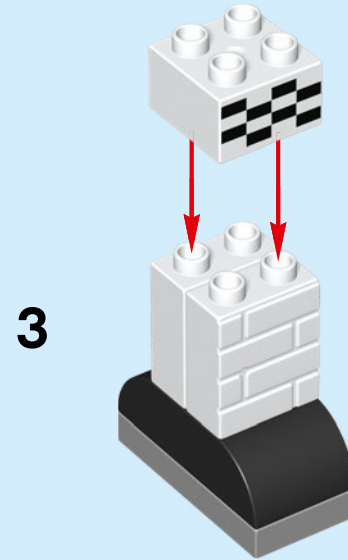
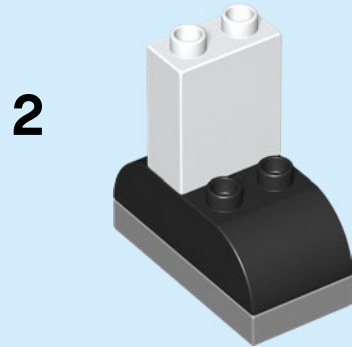
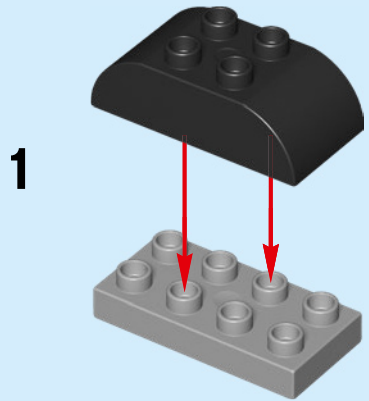



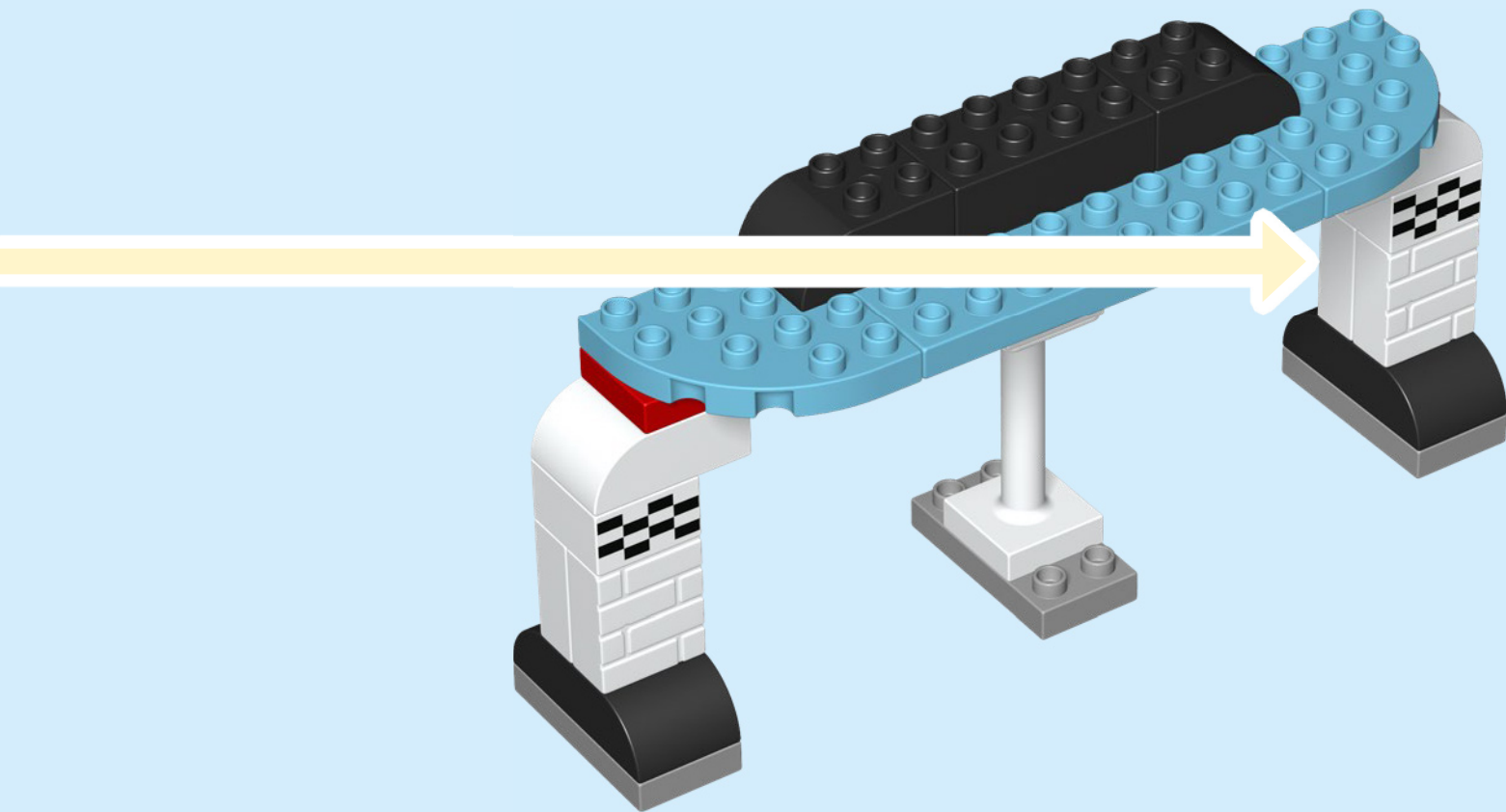



10

