



Friends

42685



LEGO® Builder



LEGO.com/sustainable-packaging



FR
DONNEZ
OU
RECYCLEZ



ASSOCIATION

OU



MAGASIN

OU



DÉCHÈTERIE

Adresses sur quefairedemesdechets.fr



BUILDER



Apple and the Apple logo are trademarks of Apple Inc., registered in the U.S. and other countries and regions. App Store is a service mark of Apple Inc. Google Play and the Google Play logo are trademarks of Google LLC. Tencent and the Tencent logo are trademarks of Tencent Inc.



EN Ask parents' permission before going online | **DE** Eltern um Erlaubnis bitten, bevor du online gehst | **FR** Demande l'autorisation d'un parent avant d'aller en ligne | **IT** Chiedi il permesso ai tuoi genitori prima di andare online | **ES** Pídeles permiso a tus papás antes de conectarte a Internet | **PT** pede autorização aos pais antes de acederes online | **ZH** 上网前应先征得父母的同意 | **PL** Poproś rodziców o zgodę, zanim wejdziesz do Internetu | **CS** Než půjdeš na internet, požádej rodiče o svolení | **SK** Skôr než pôjdeš na internet, vypýtaj si povolenie od rodičov | **HU** Kérj szülői engedélyt, mielőtt online csatlakoznál! | **UA** Запитуйте дозволу батьків, перш ніж користуватися інтернетом | **RO** Cere permisiunea părinților înainte de a te conecta online | **BG** Поискайте разрешение от родител, преди да влезете онлайн | **LV** Pirms došanās tiešsaistē palūdz atļauju vecākiem | **ET** Enne Interneti kasutamist küsi vanematelt luba | **LT** Prieš prisijungdami prie interneto, atsiklauskite tėvų



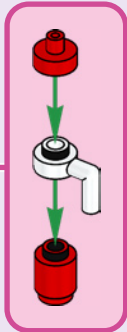
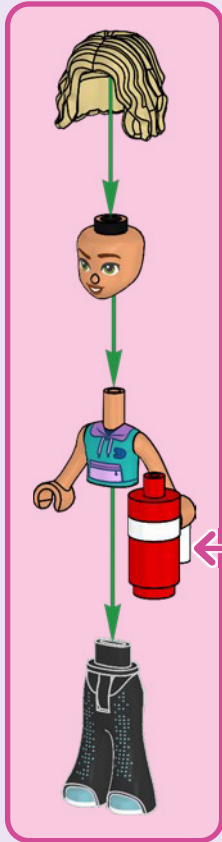

Nova



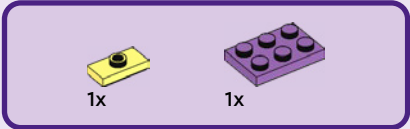

1

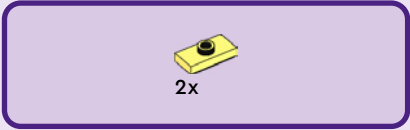
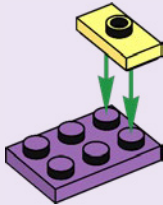

2

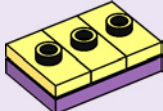



3x

3

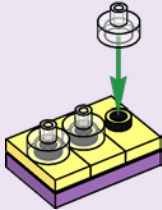

1x

4

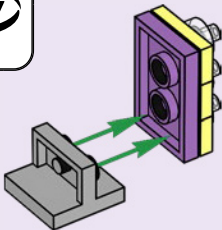
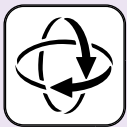

1x

5

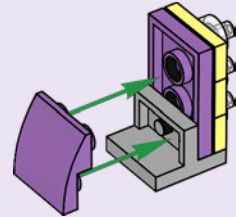

1x



1x



1x

6



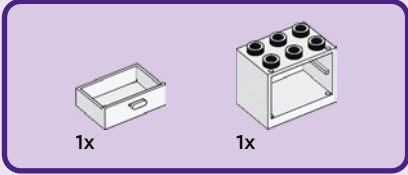

1

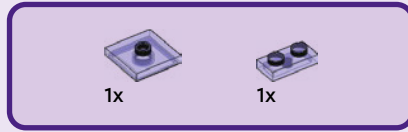
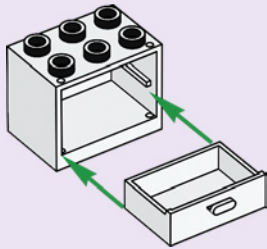

2

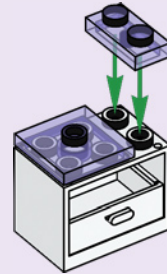

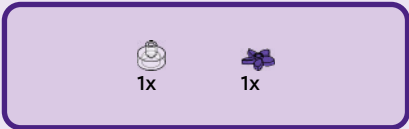

3

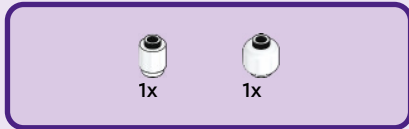
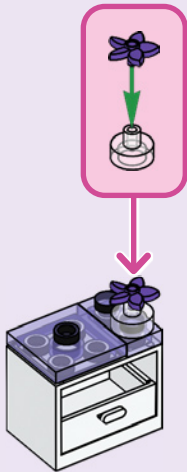

4

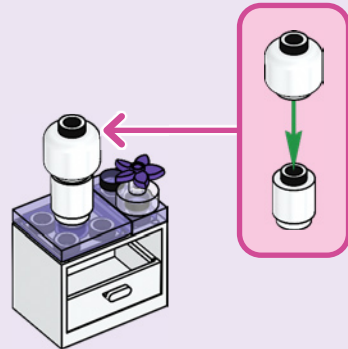

5



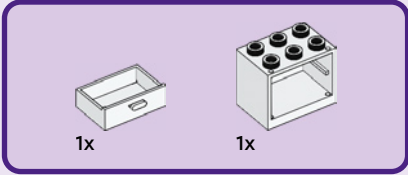

1

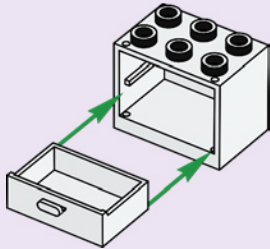

2

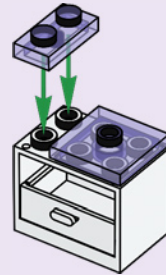

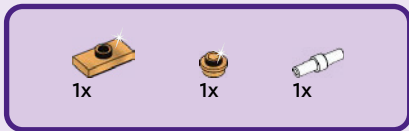

3

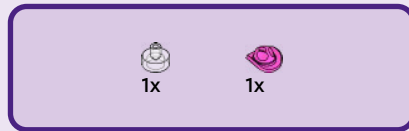
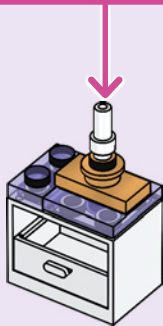
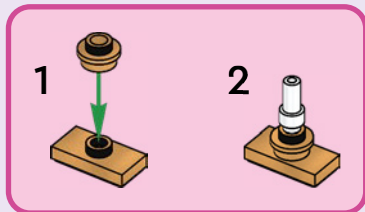

4

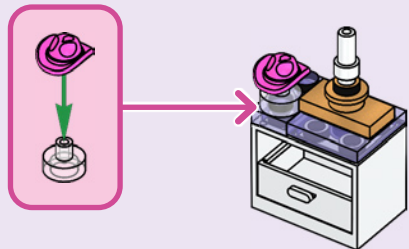

5









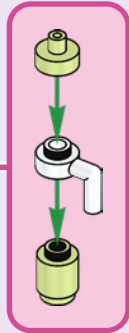
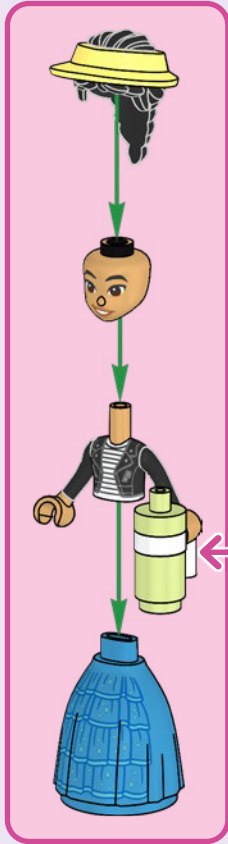

Liann







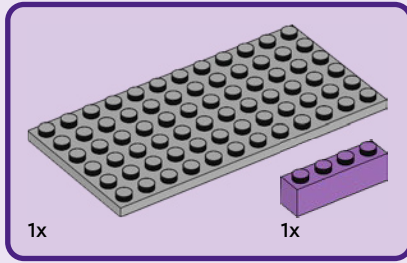

1

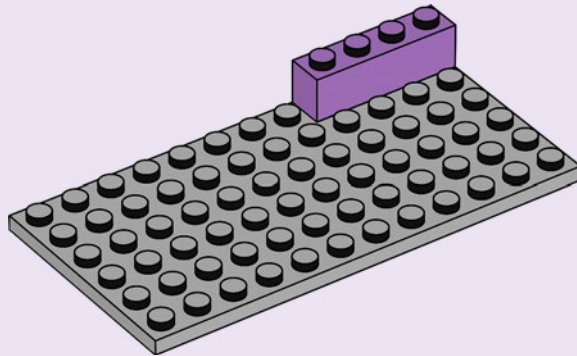

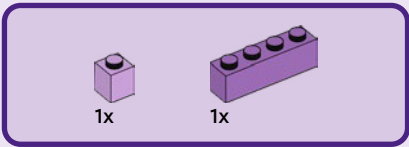

2

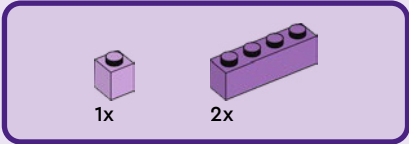
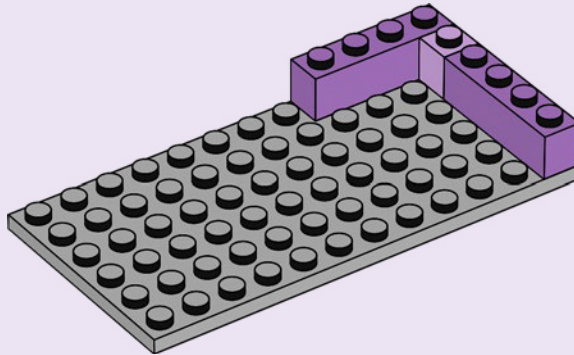

3

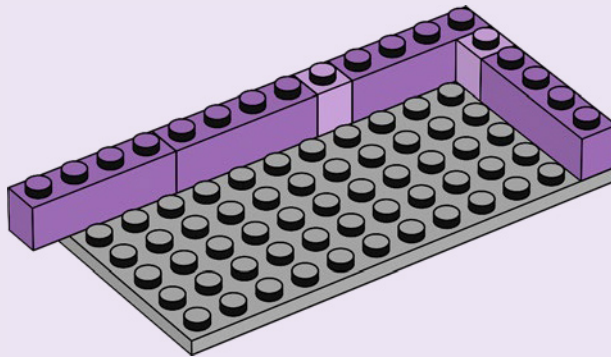

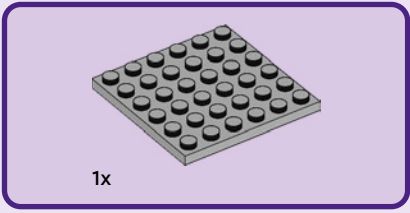

4

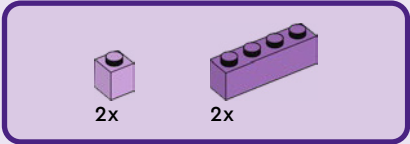
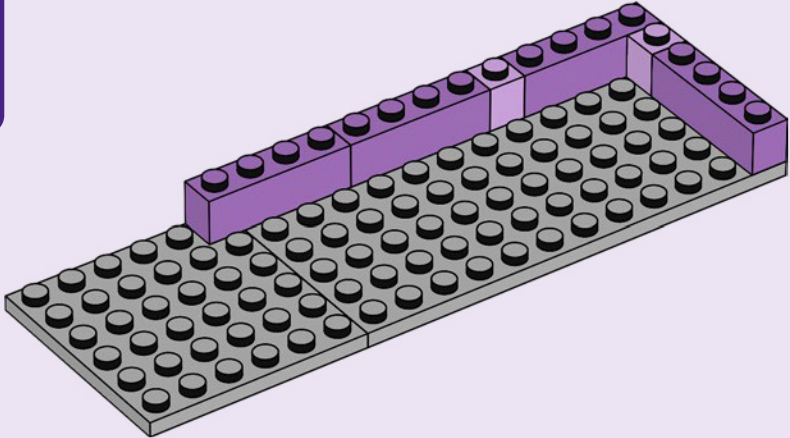

5

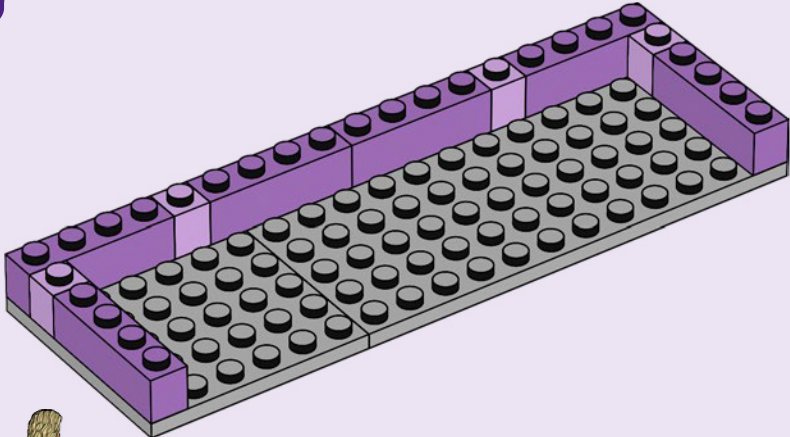

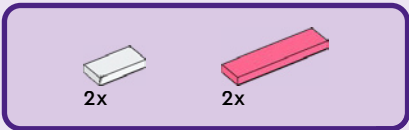

6

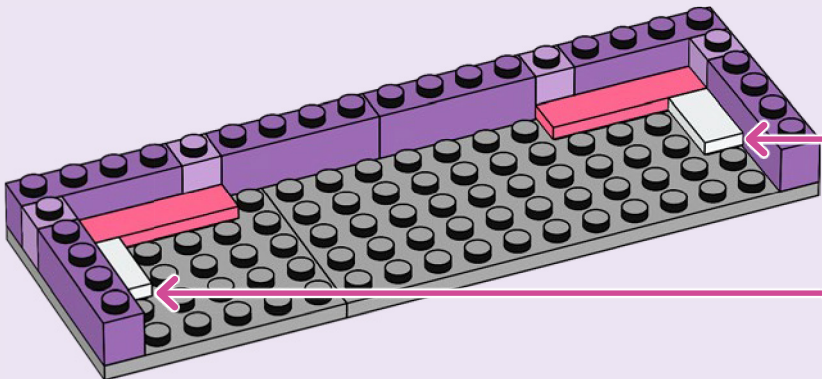

7

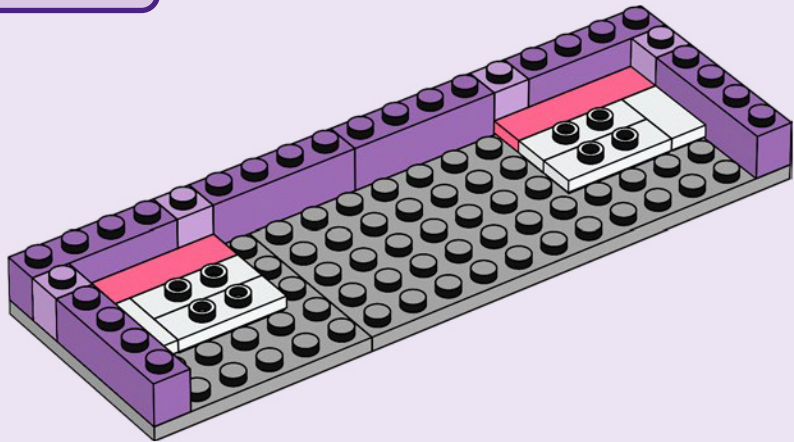

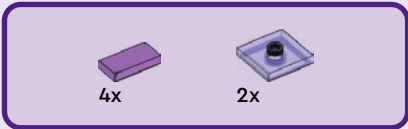

8

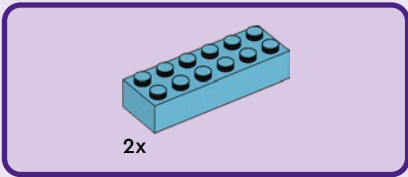
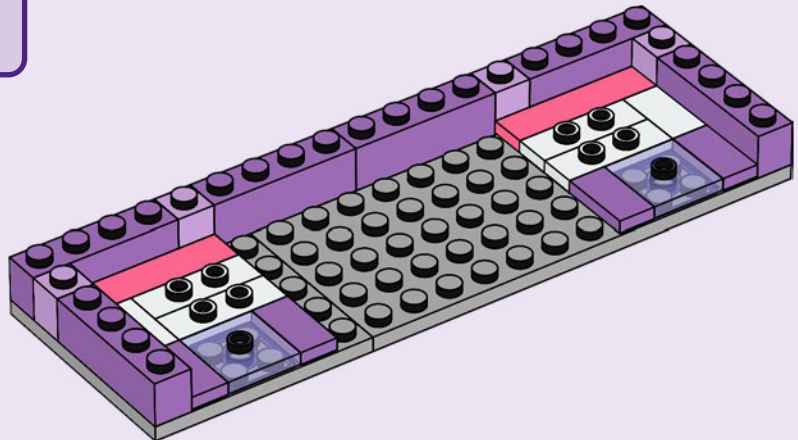

9

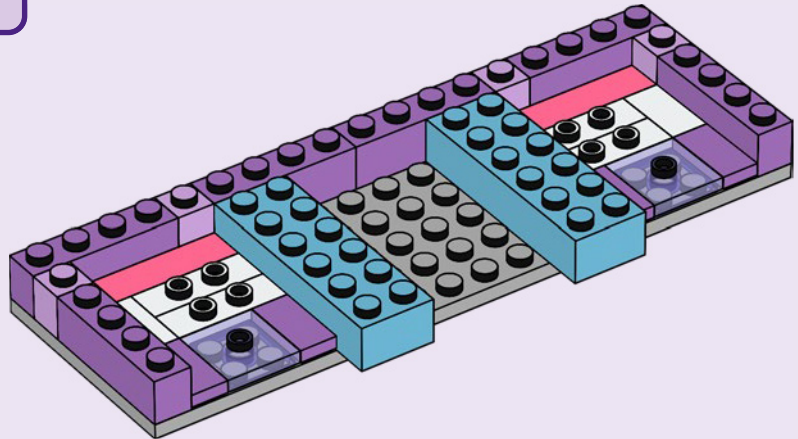

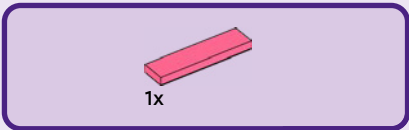

10

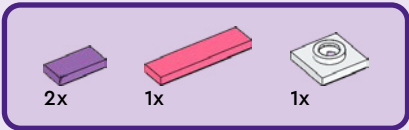
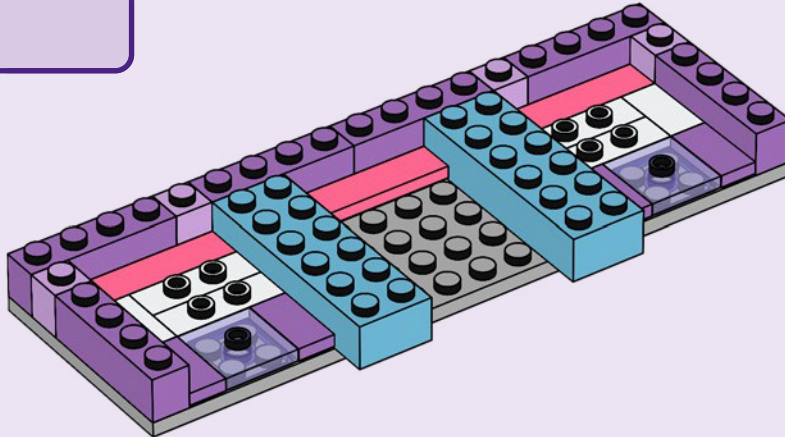

11

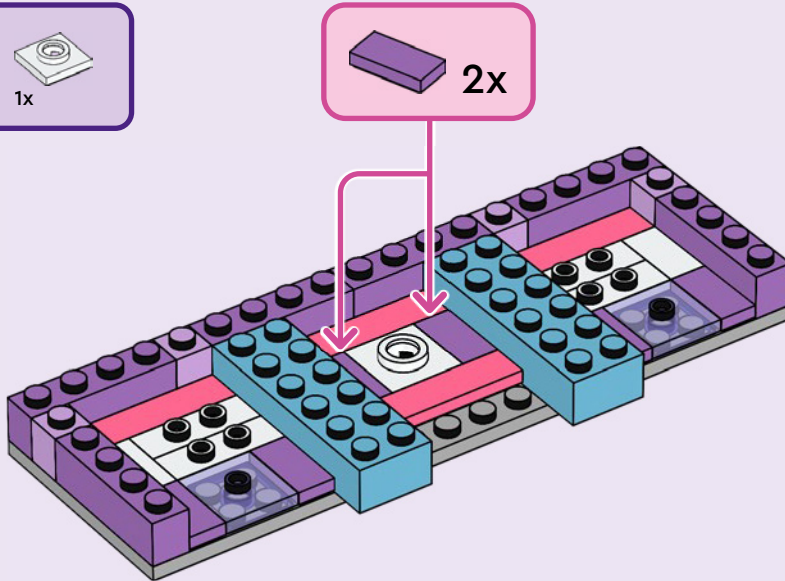



12

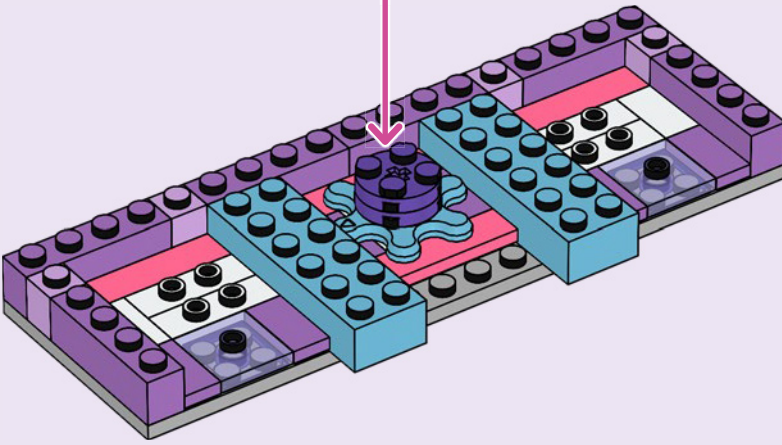
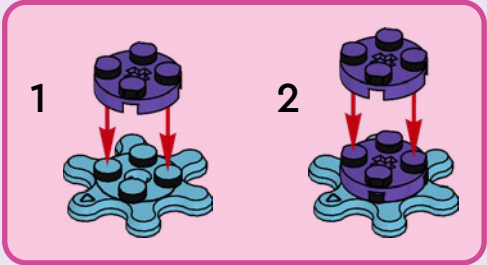

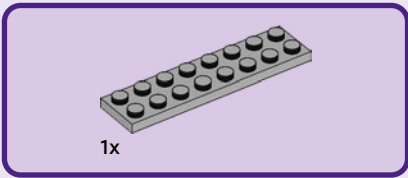

13

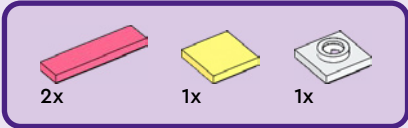
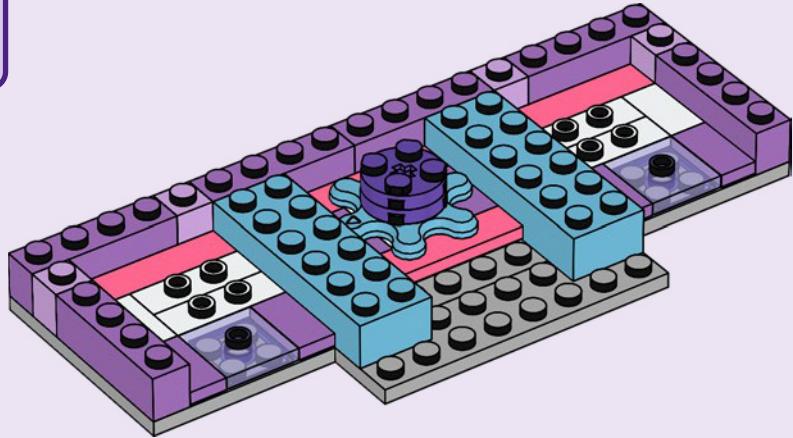

14

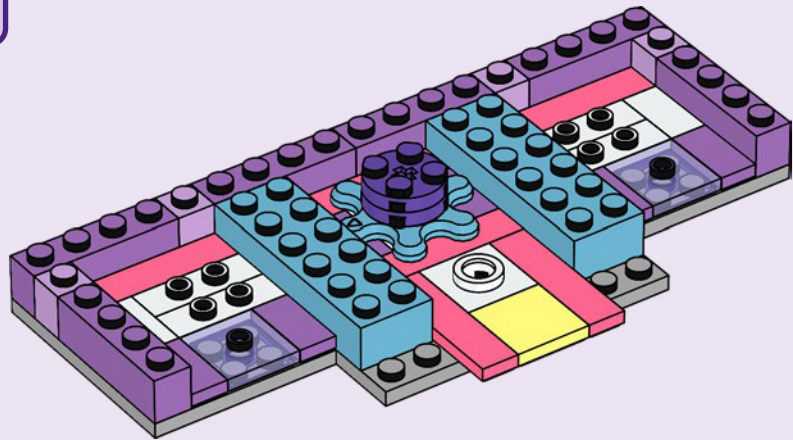



15

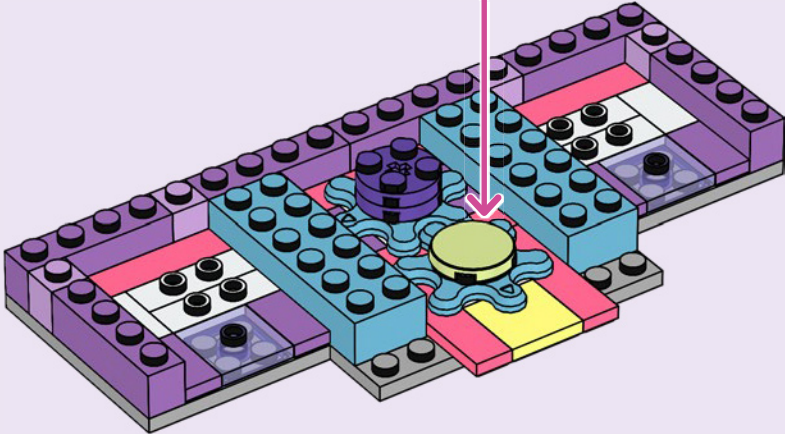
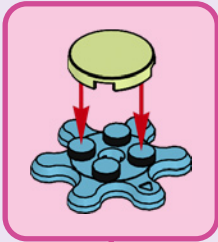

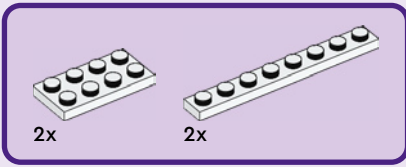

16

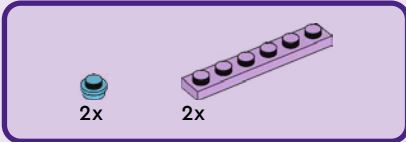
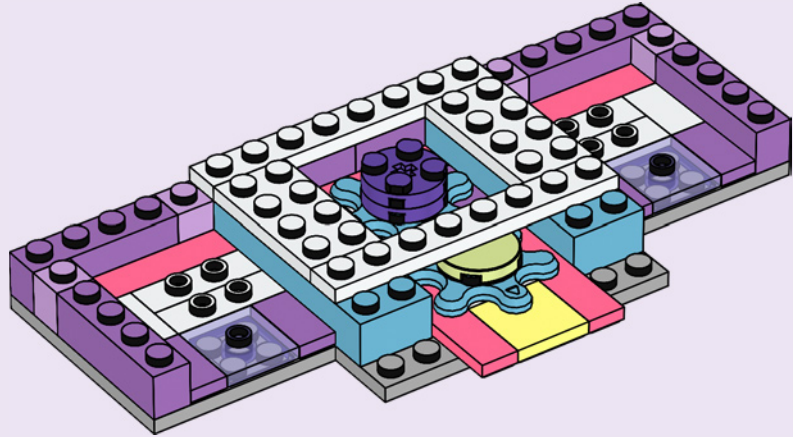

17

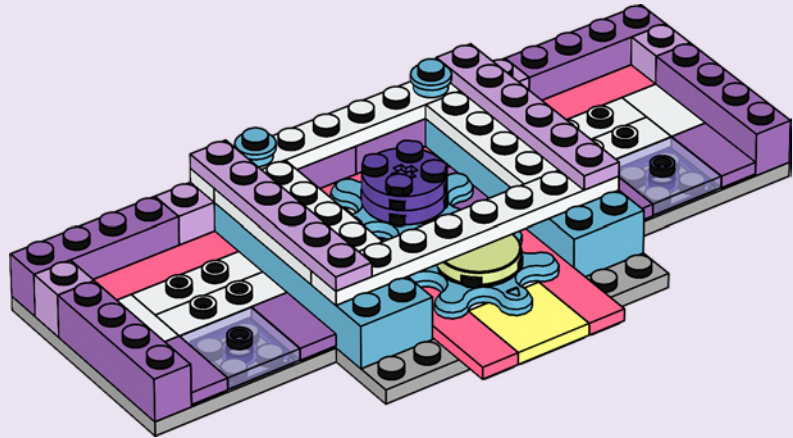



4x

18

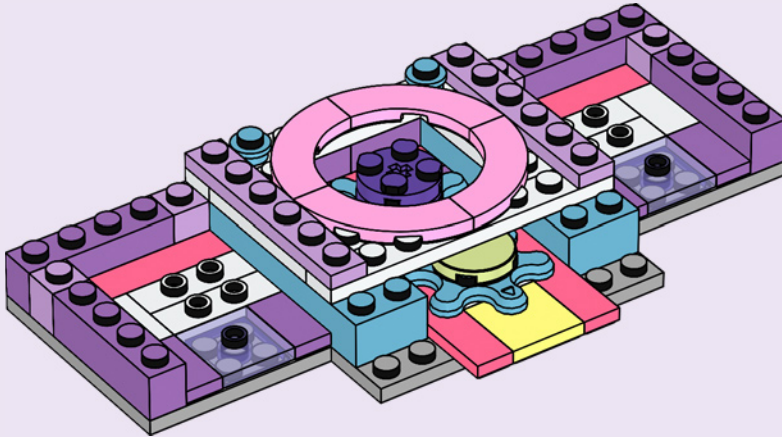



2x

19

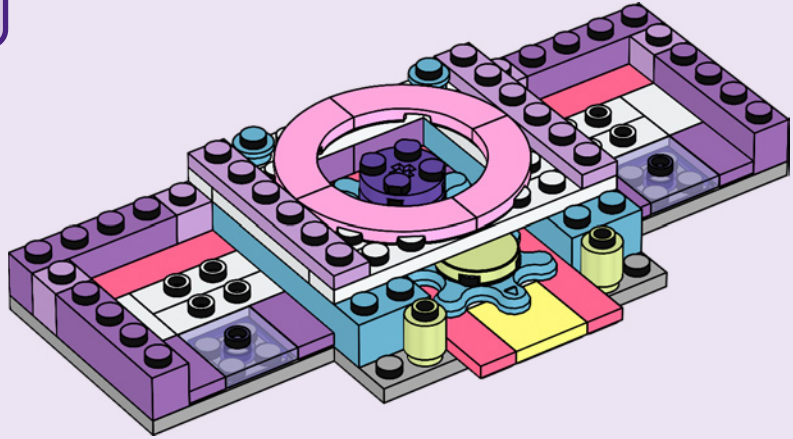

1x

20

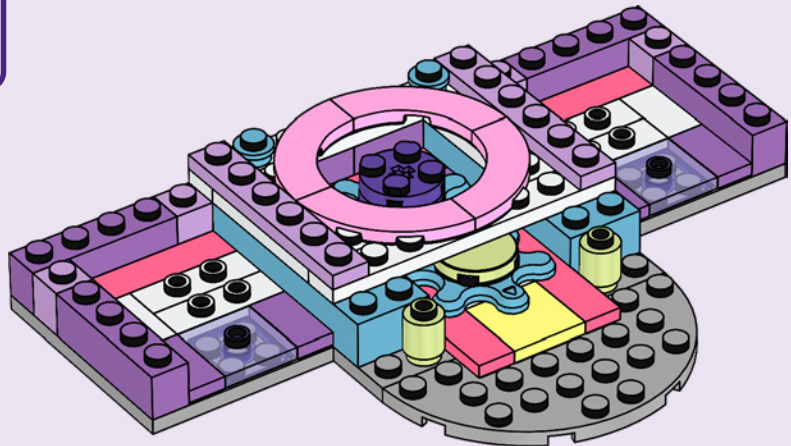



2x

21

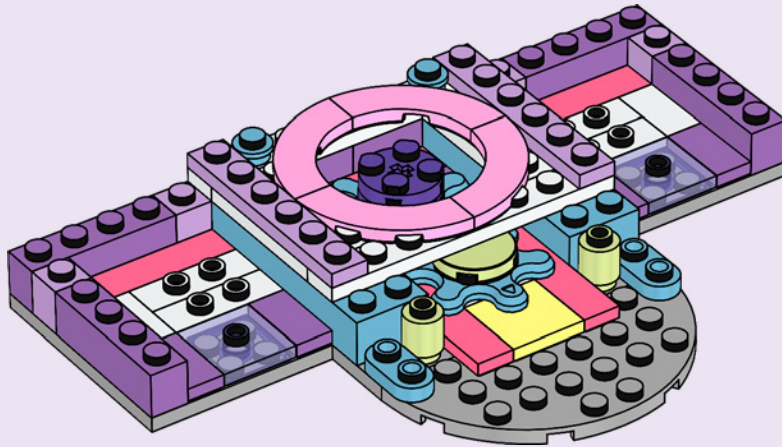



2x



2x

22

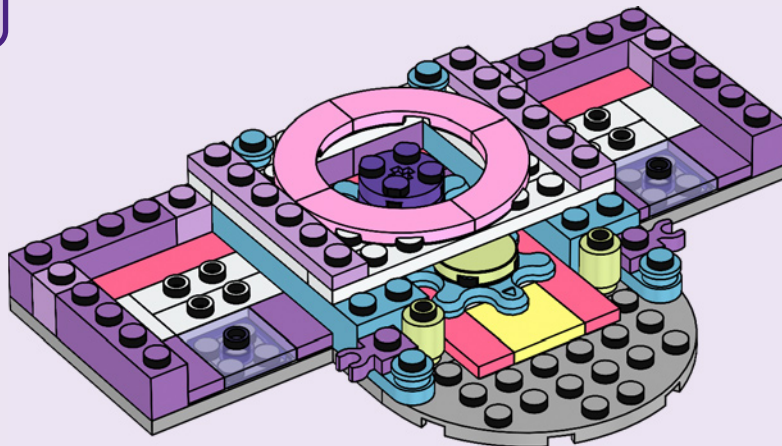

2x

23

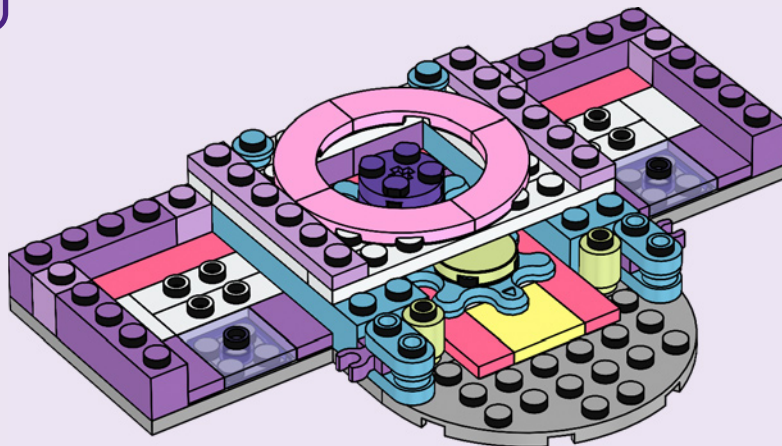



4x



1x

24

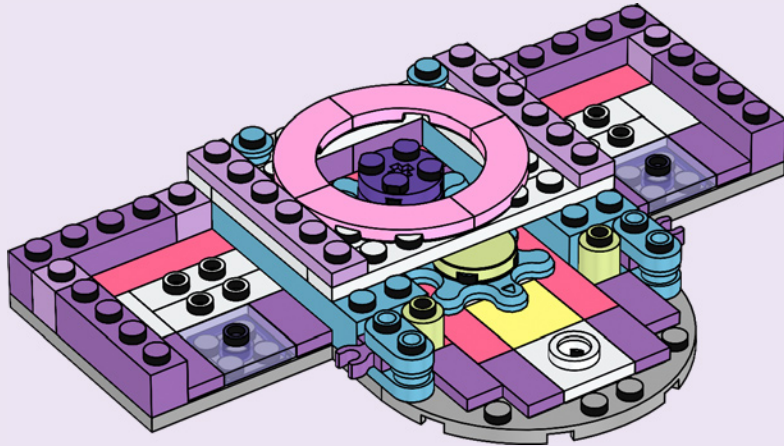



4x

25

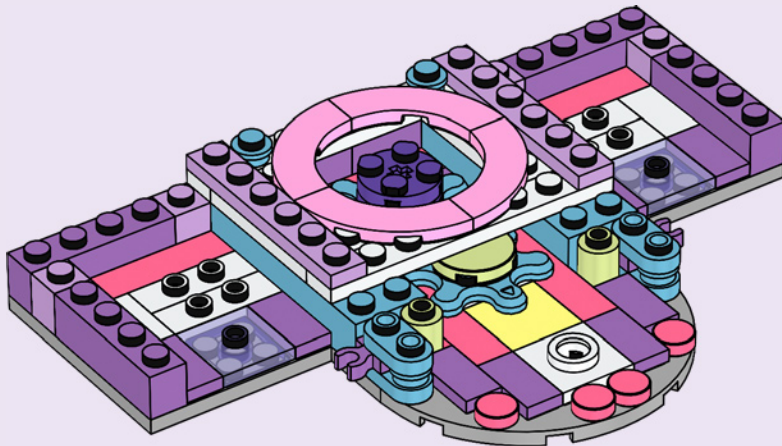

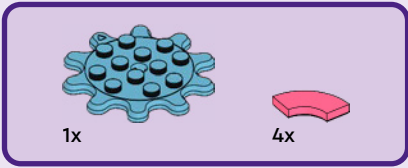

26

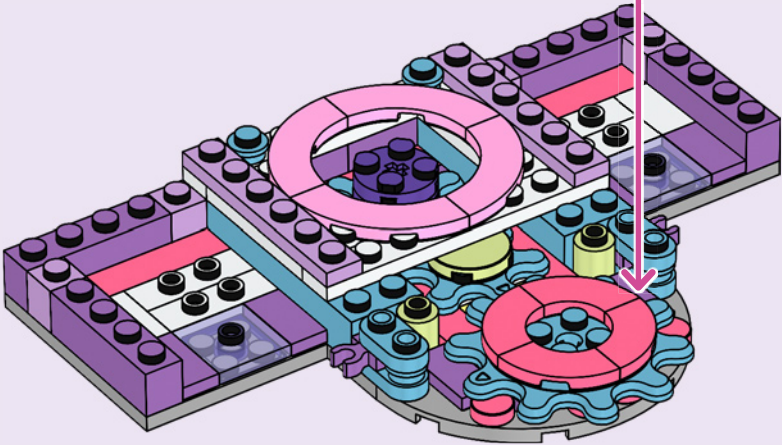
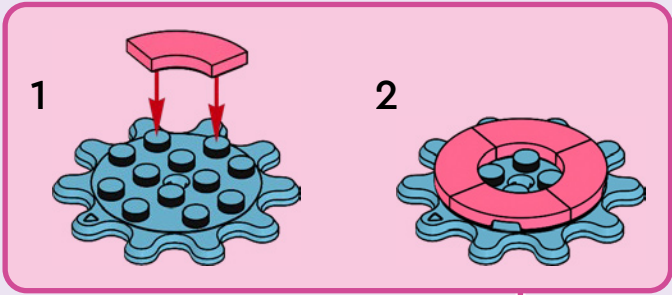



1x

27

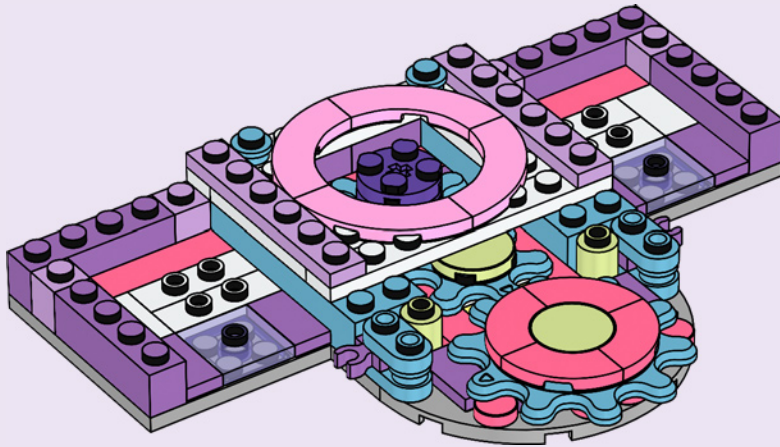

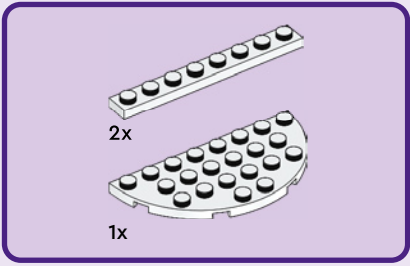

28

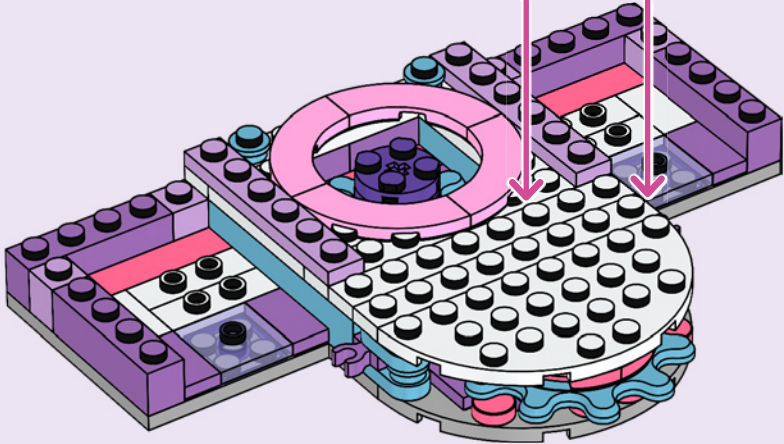
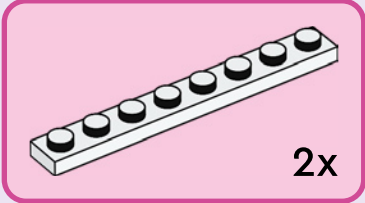



29

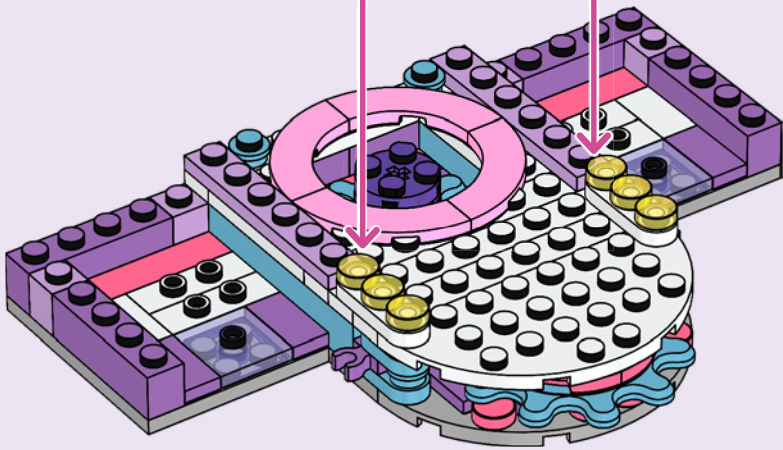
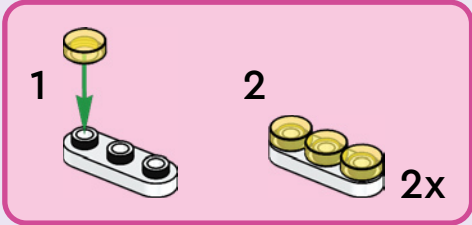

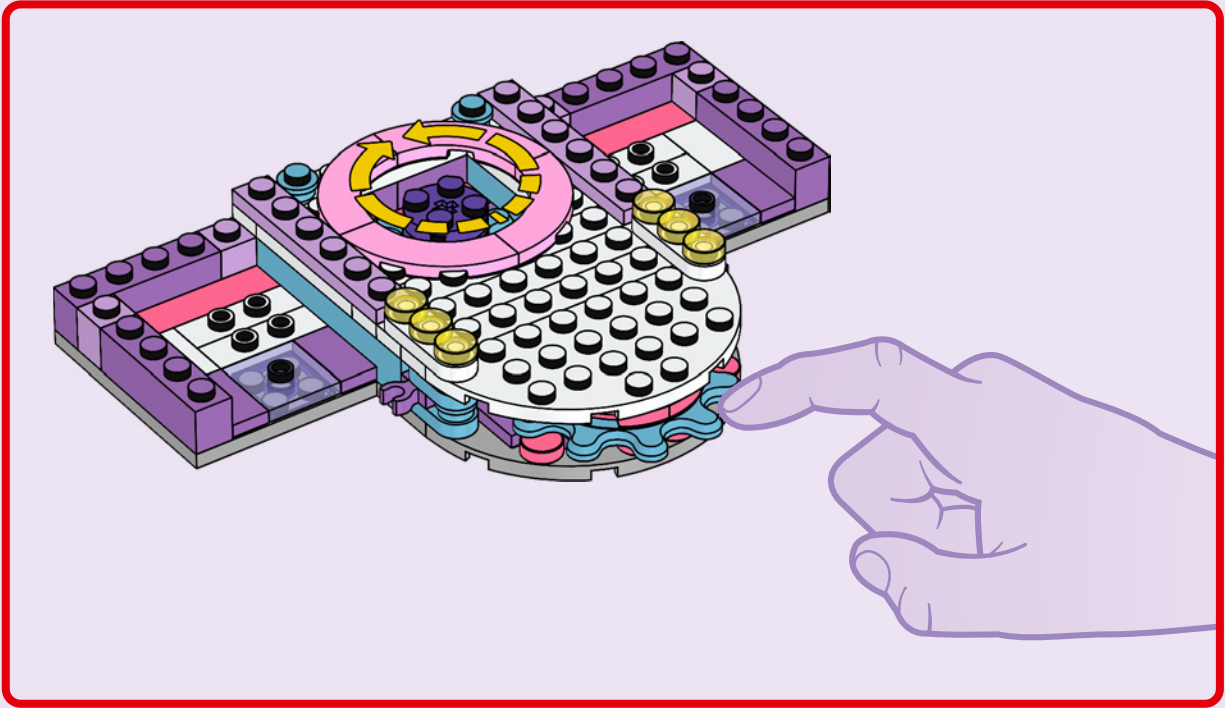



30

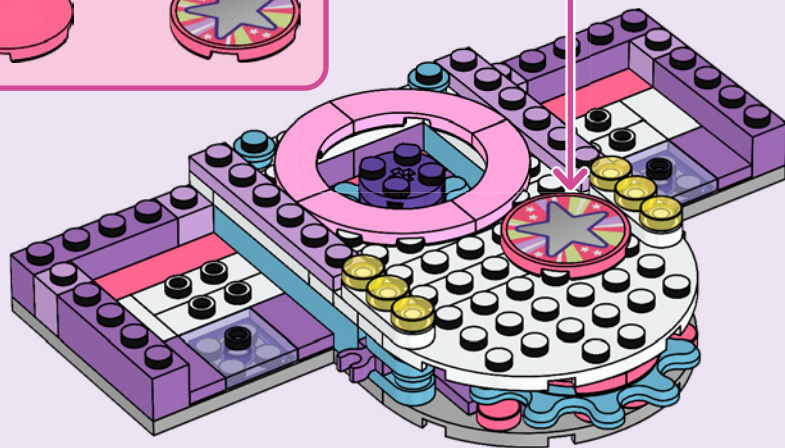
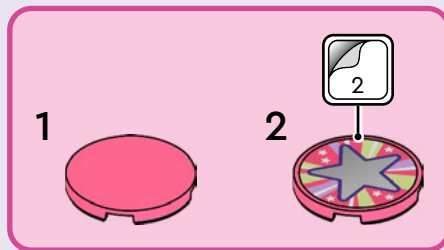

31

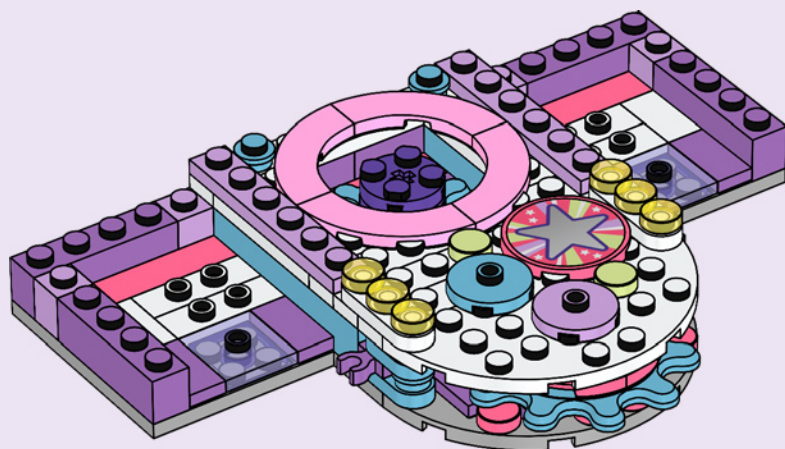

32

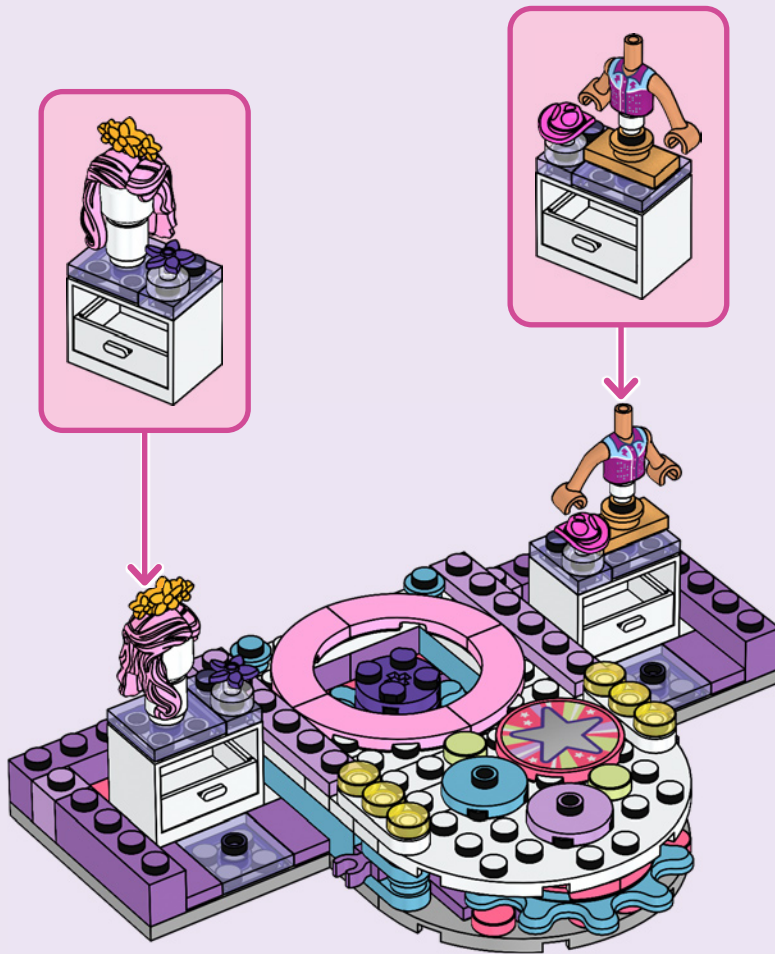

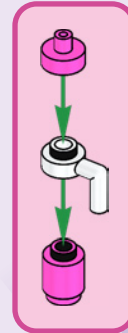
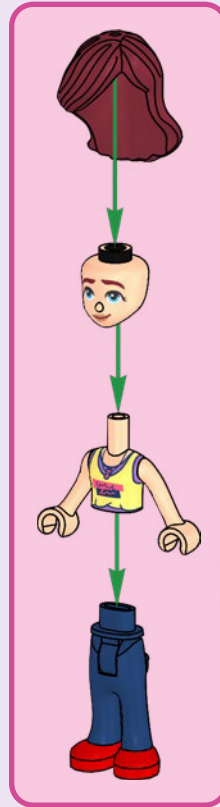

Paisley



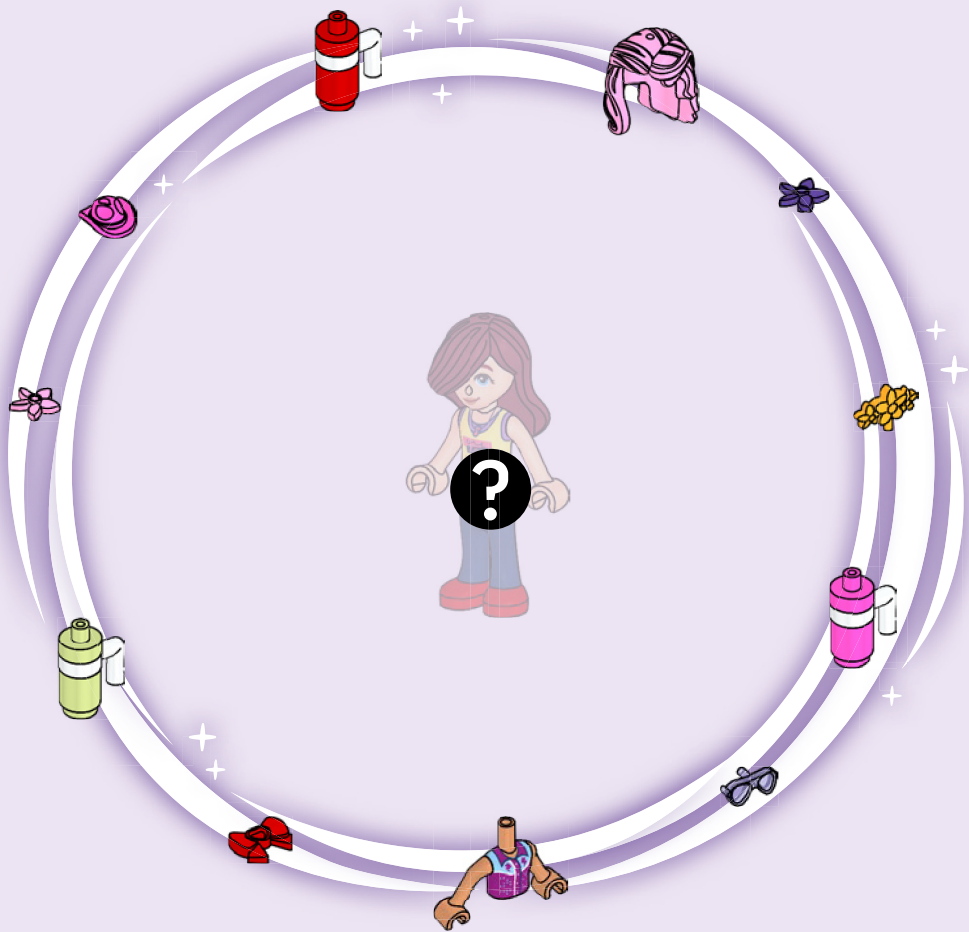



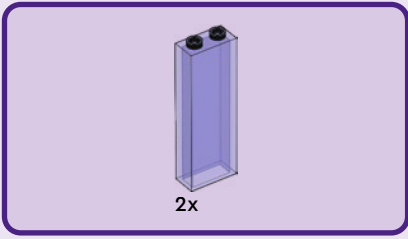

33



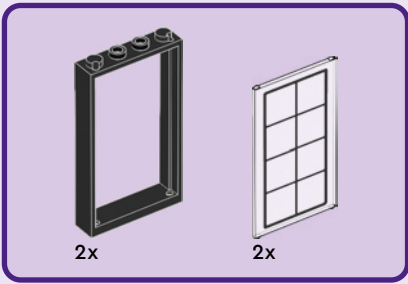

34

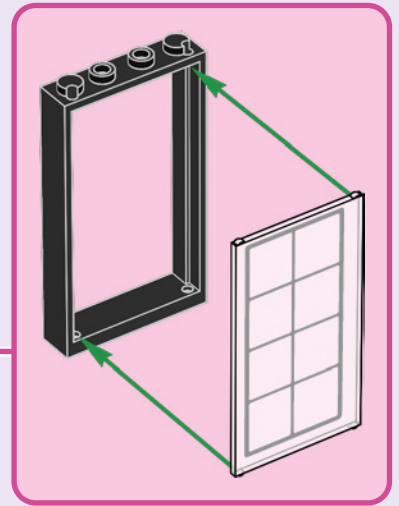
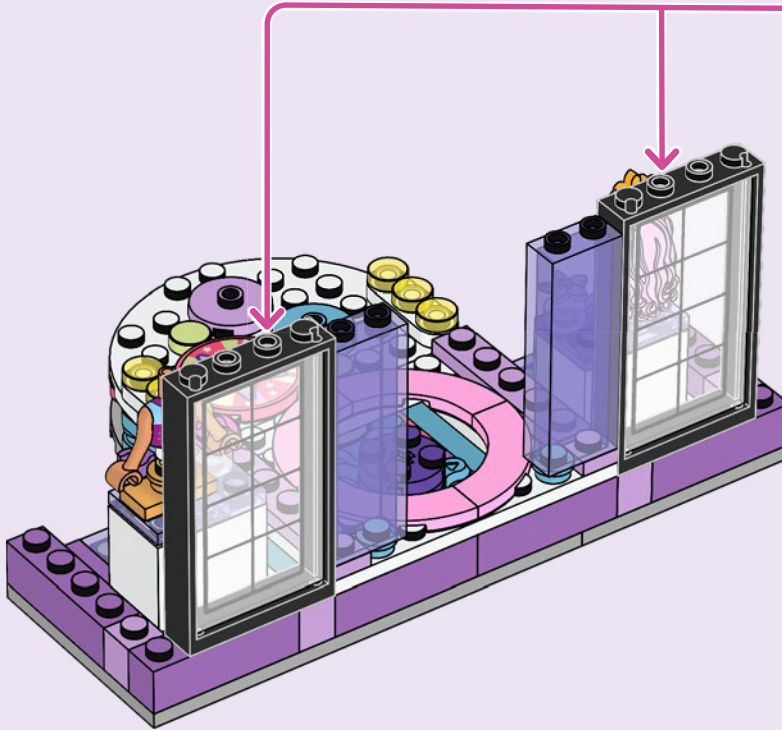

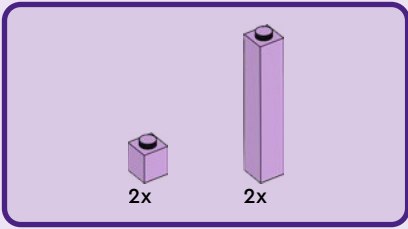

35

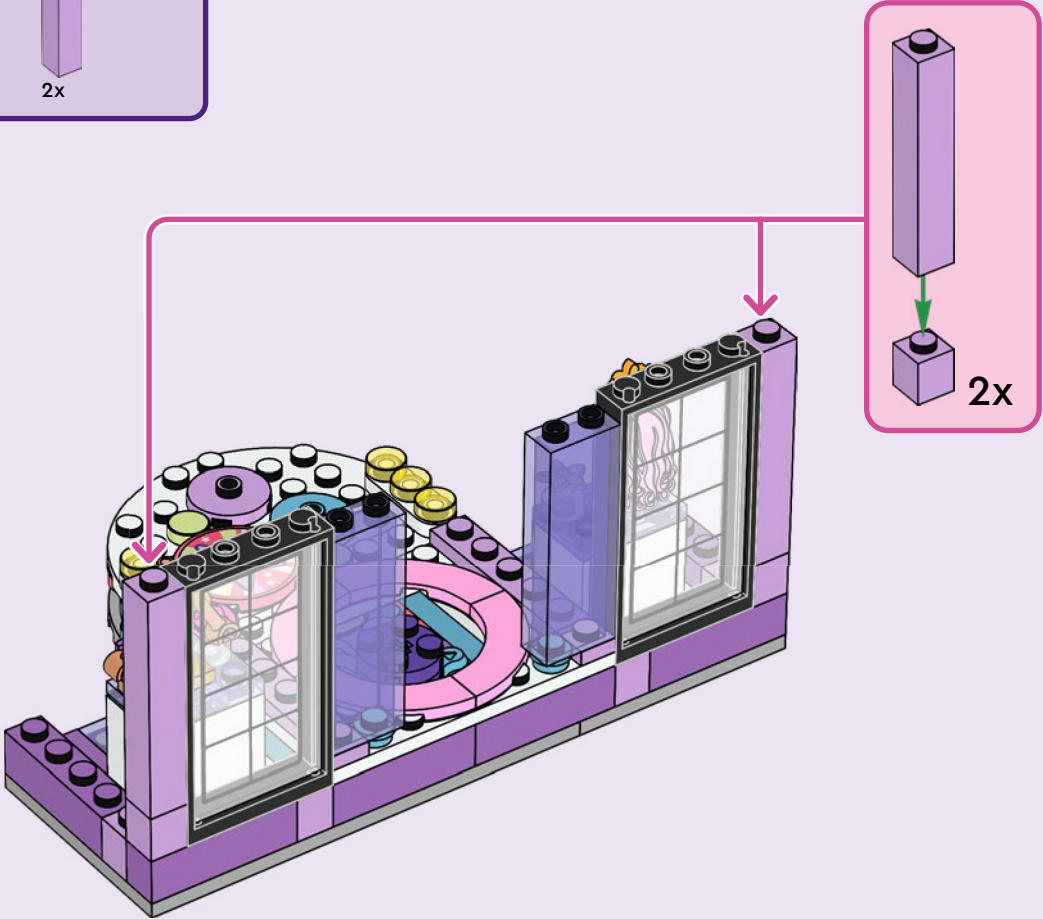

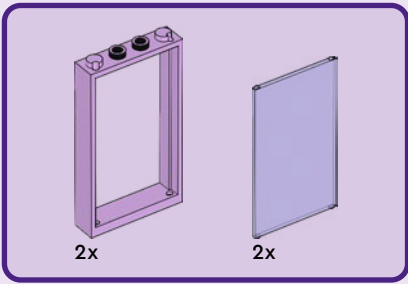

36

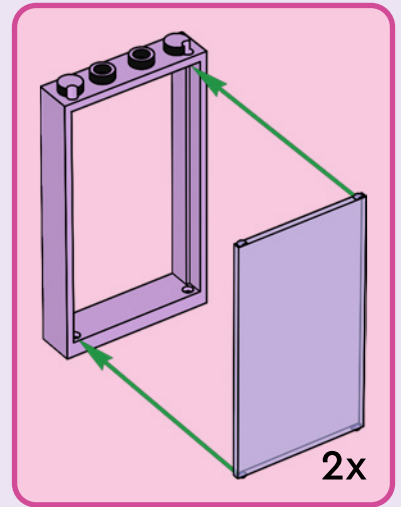

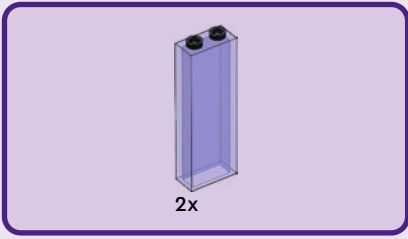

37



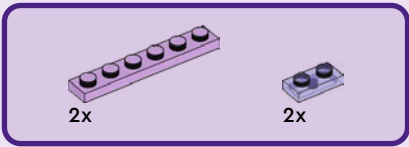

38

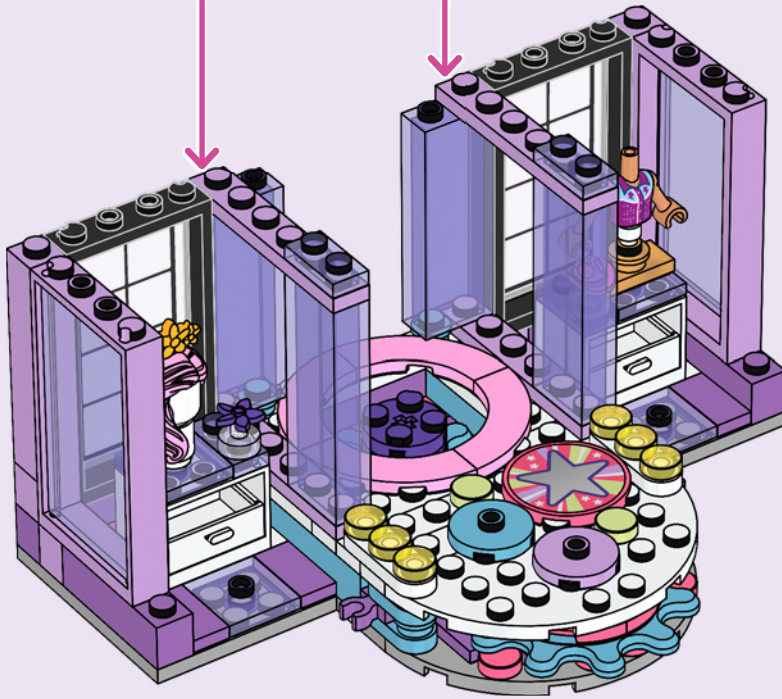
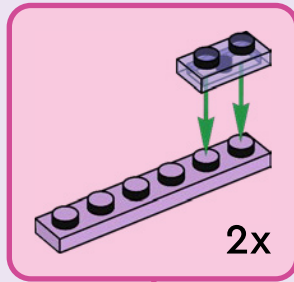



4x

39



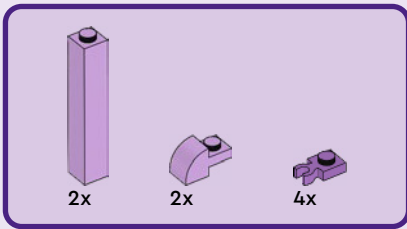

40

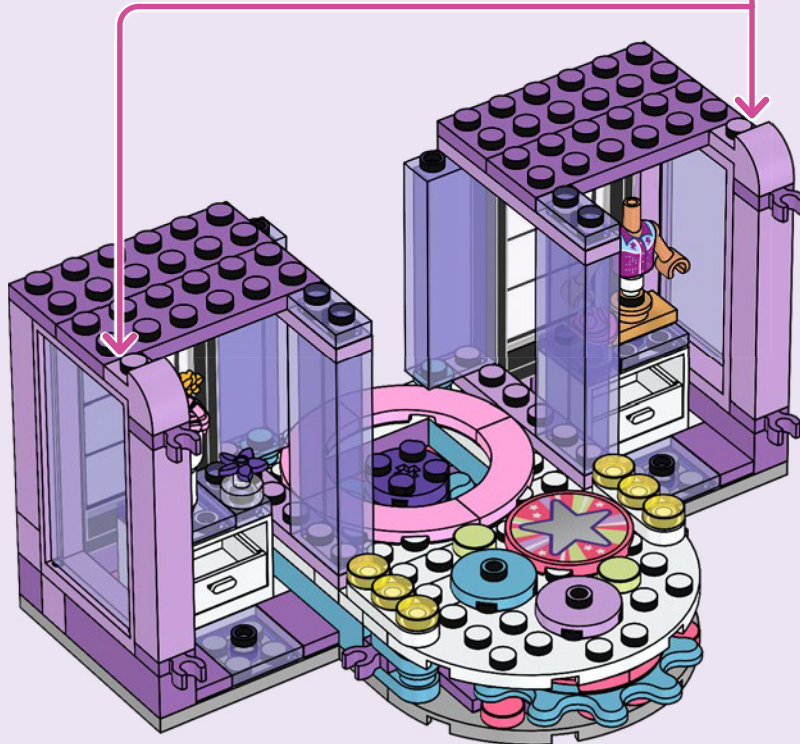
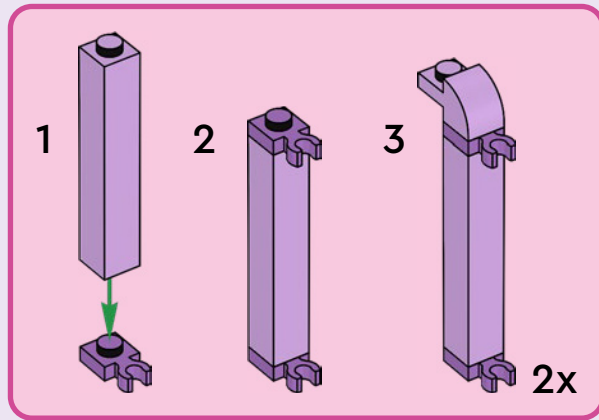



2x



2x

41



2x

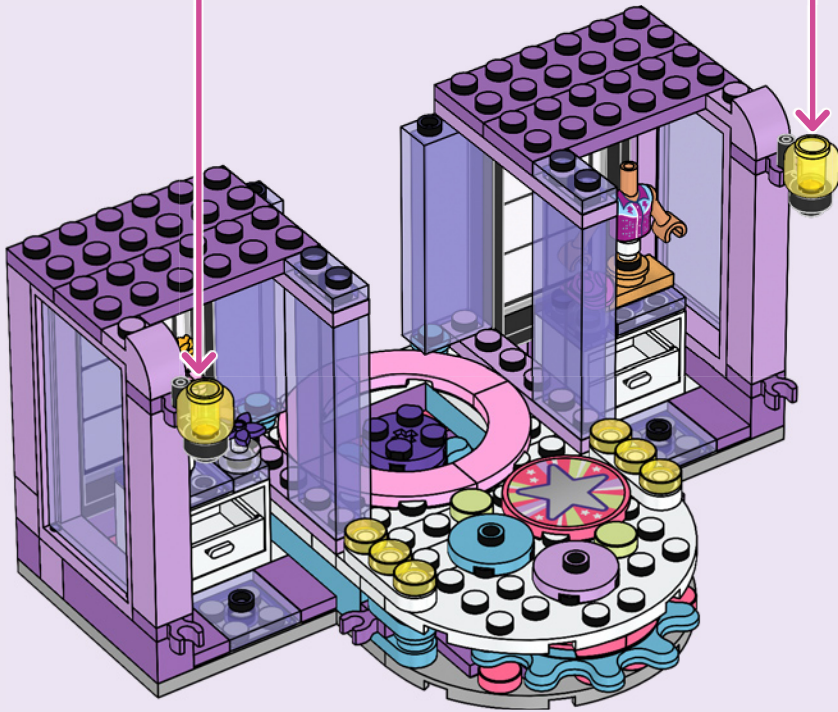

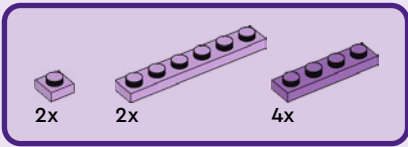

42

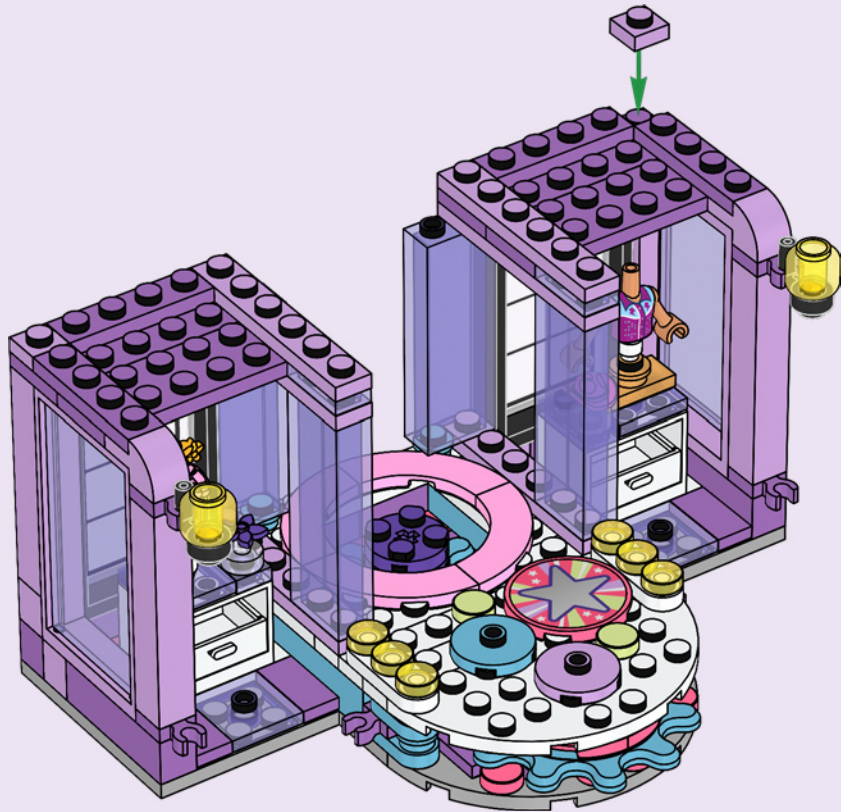

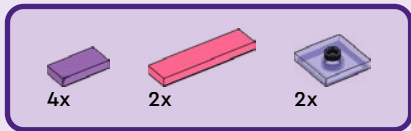

43

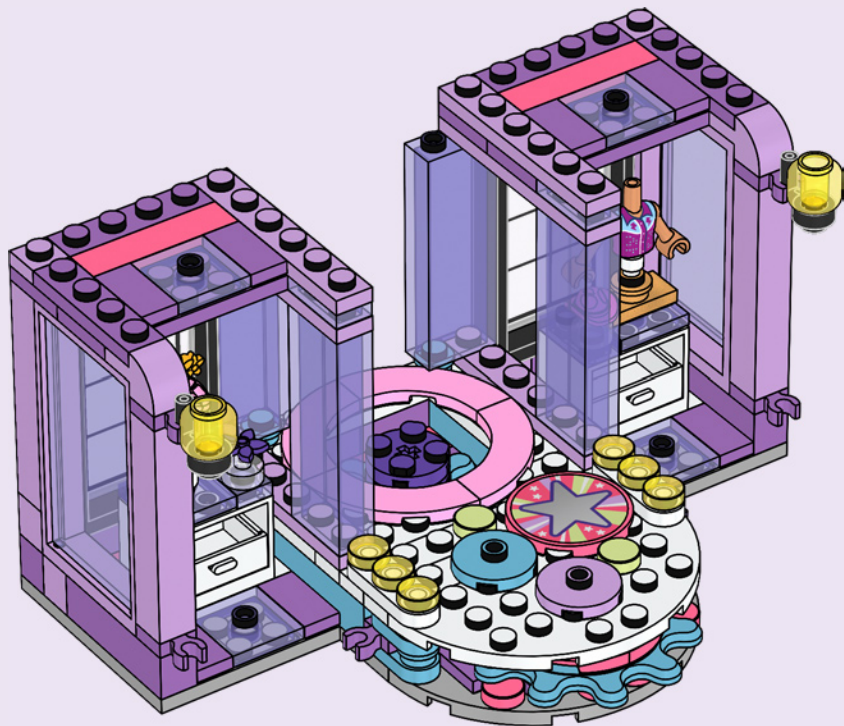



2x

44

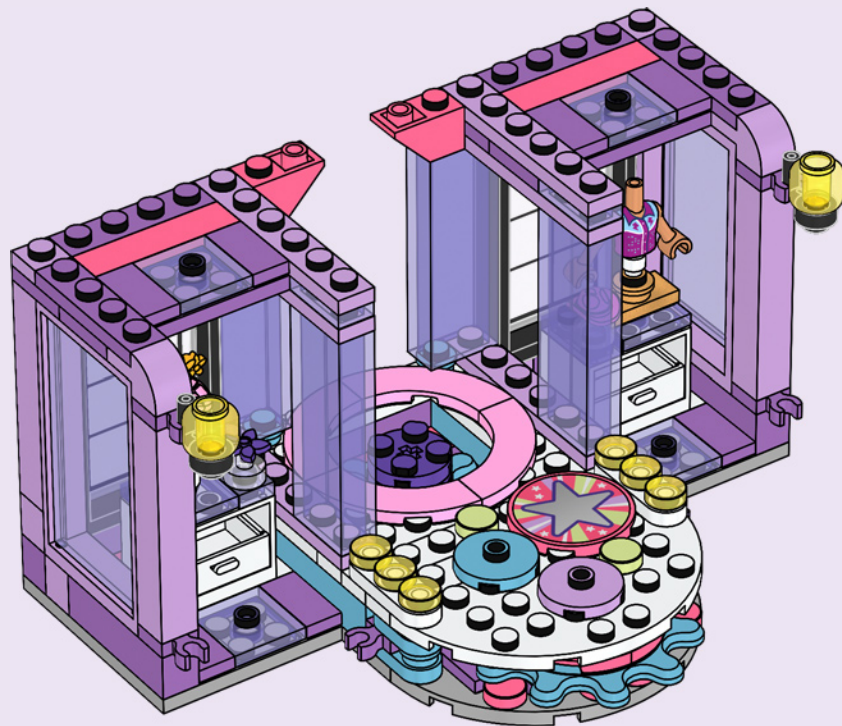

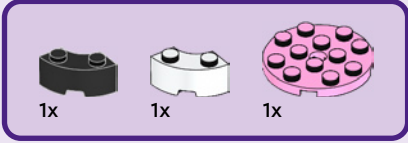
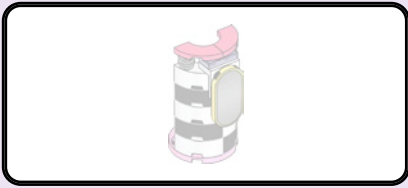

45

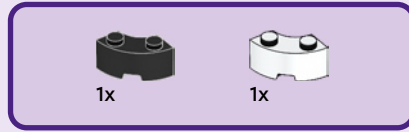
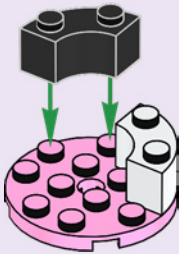

46



47



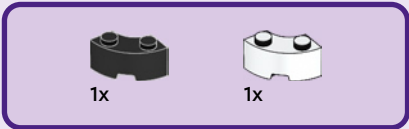

48

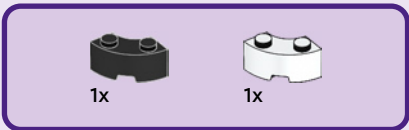
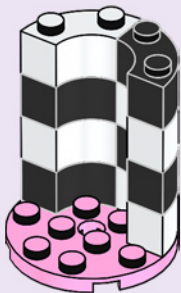

49

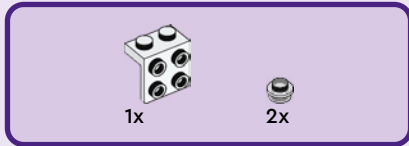
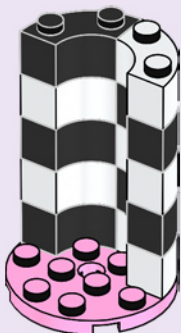

50





1x



2x

51

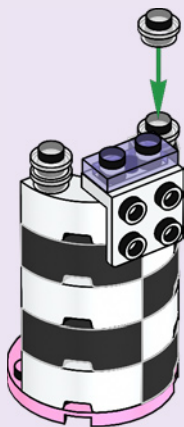

2x

52





53

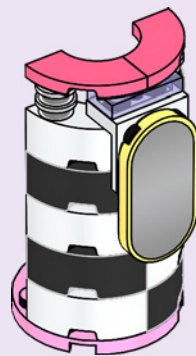
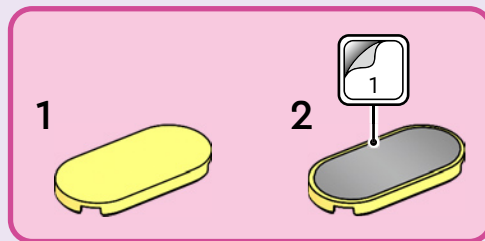

54

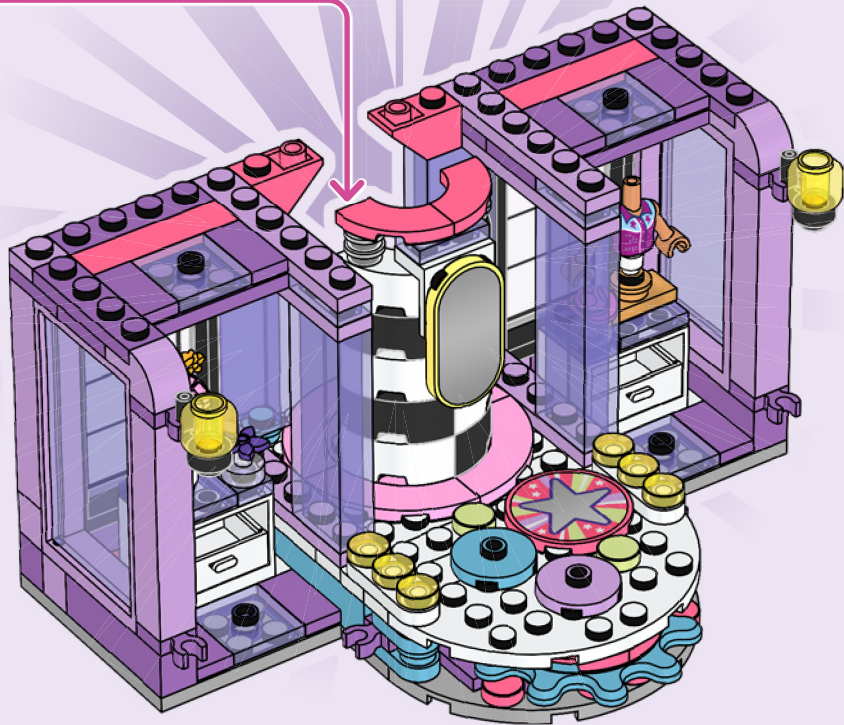

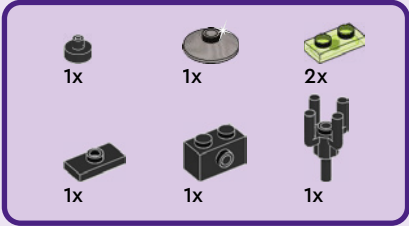
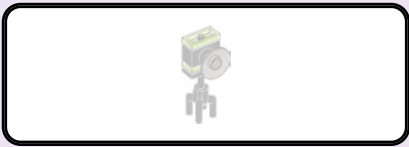

55

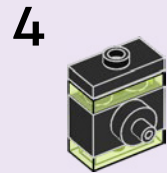
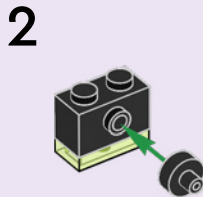
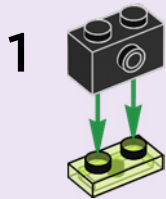

5

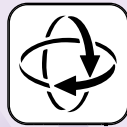

6

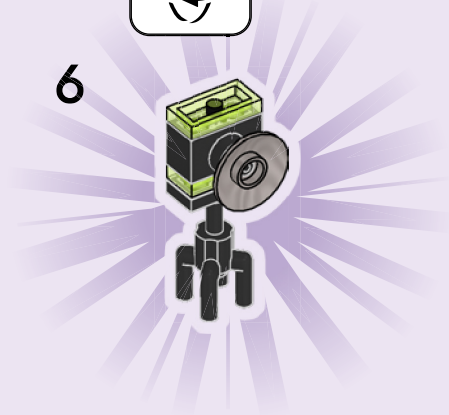

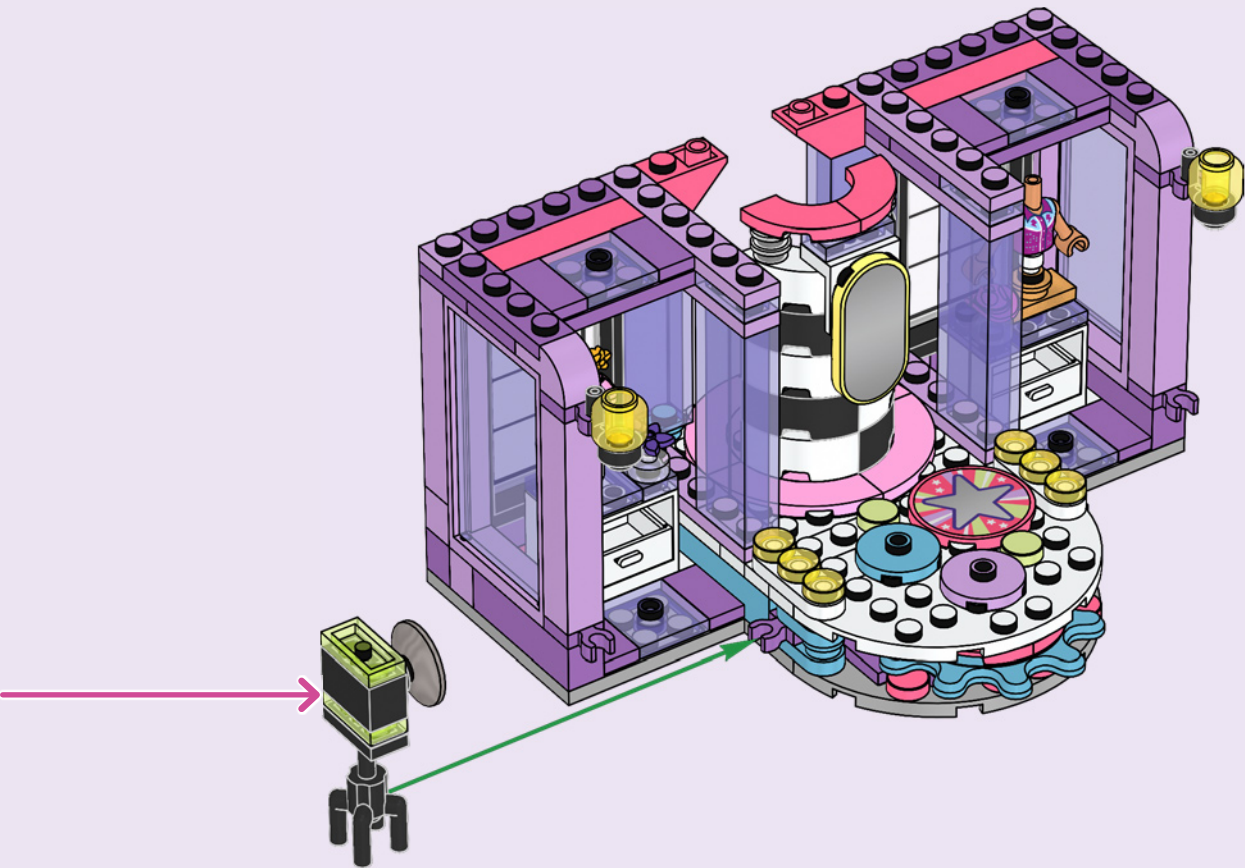

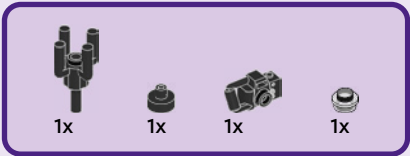

56

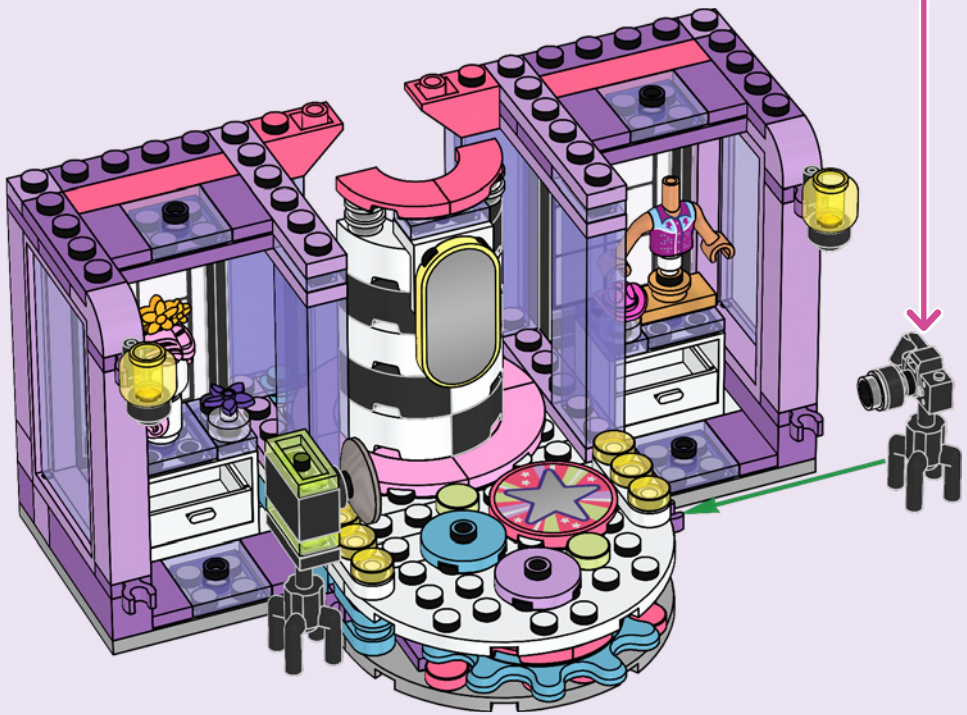
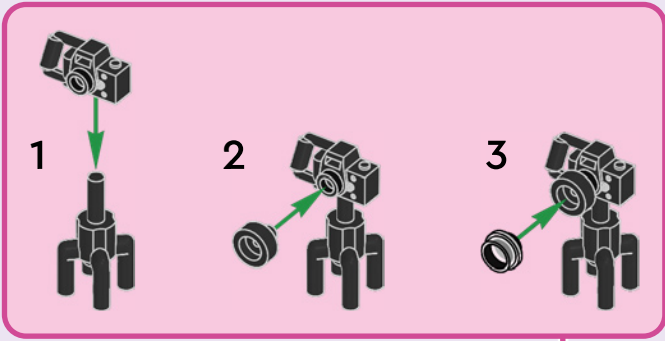



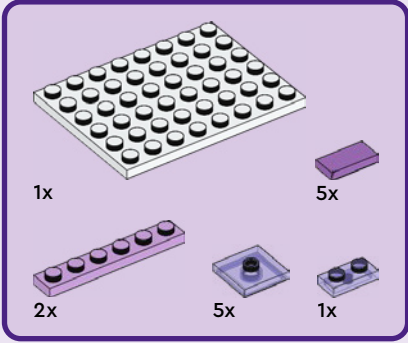
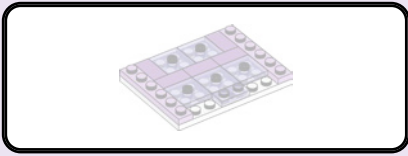

57

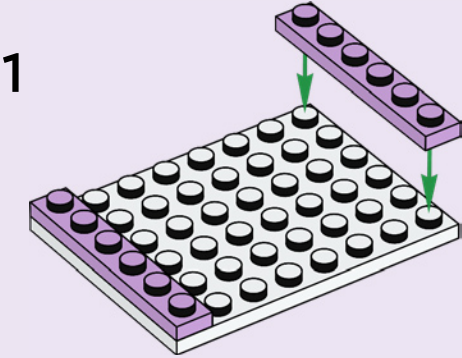

2

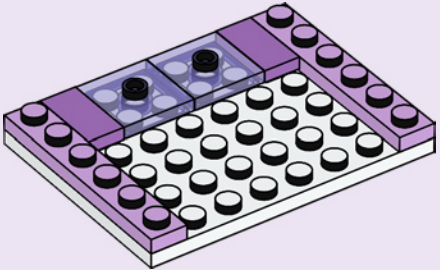

3

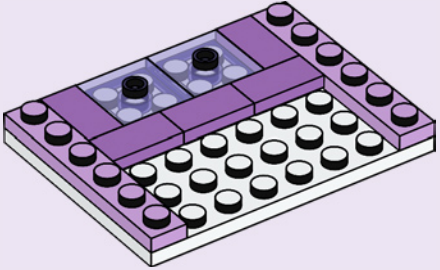

4

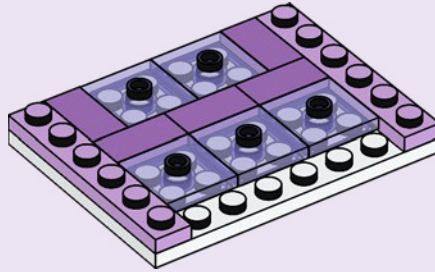

5

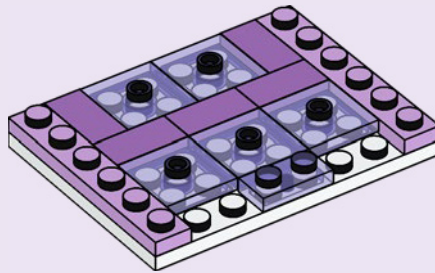

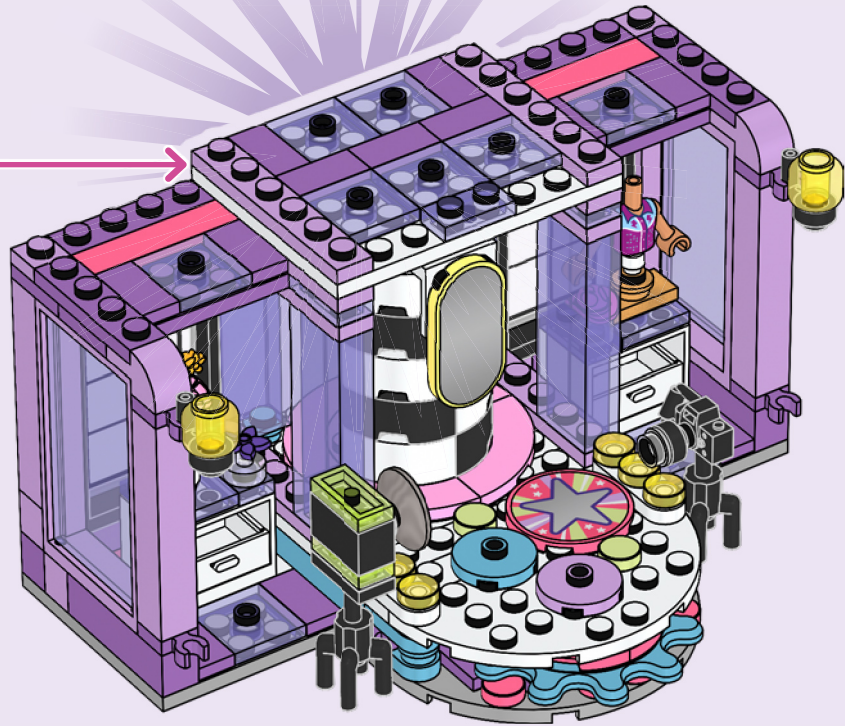

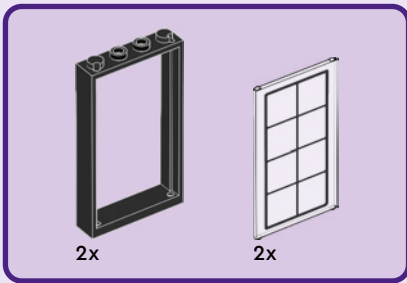

58

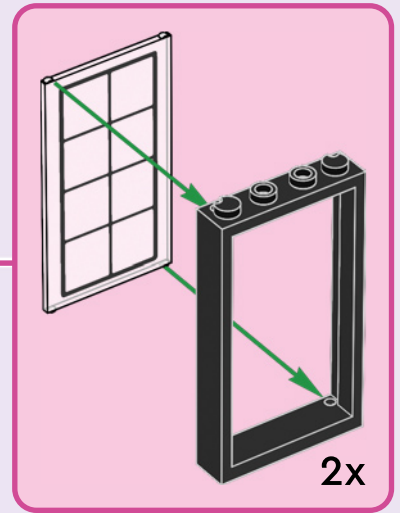
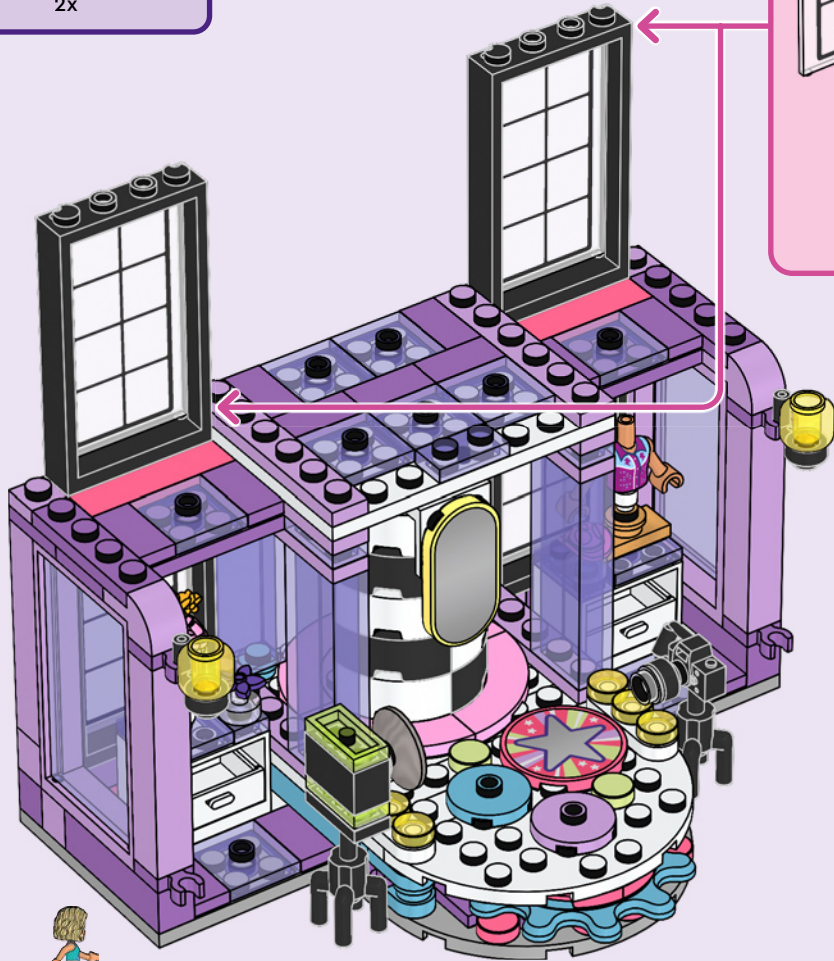

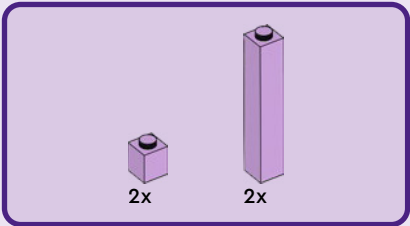

59

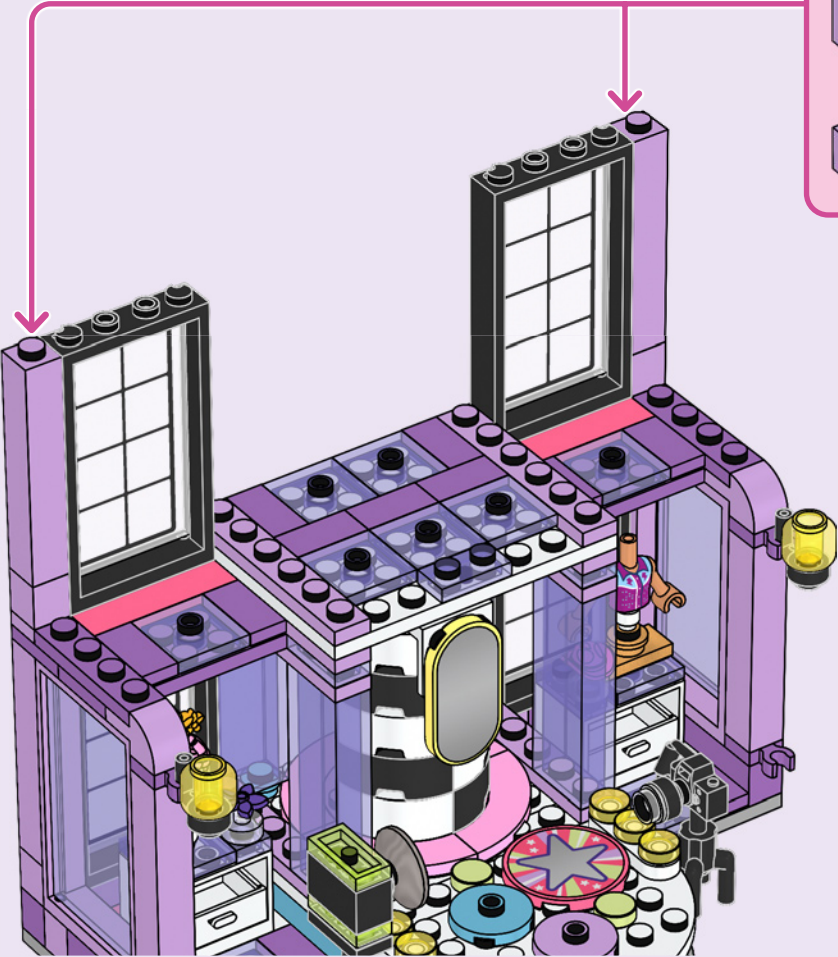
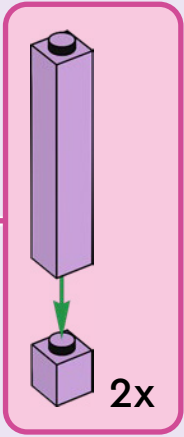

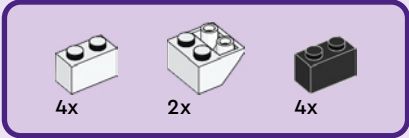
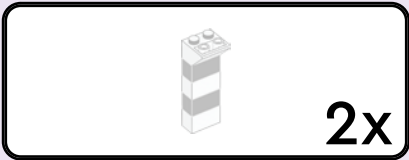

60

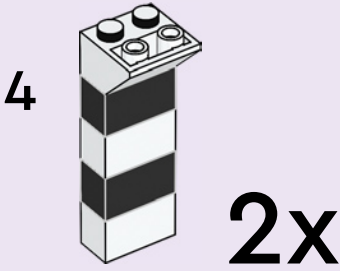
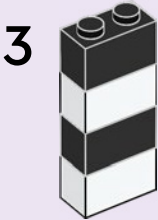
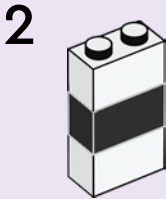
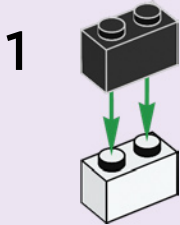

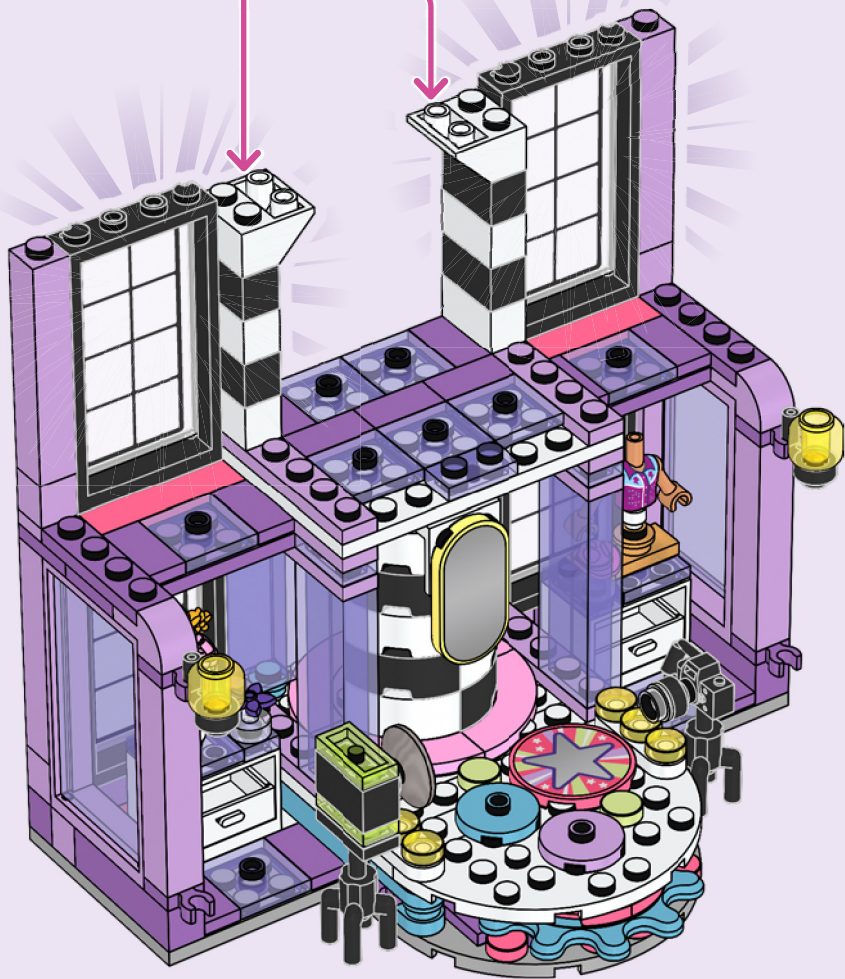

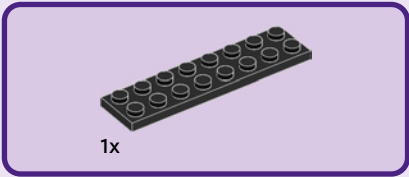

61

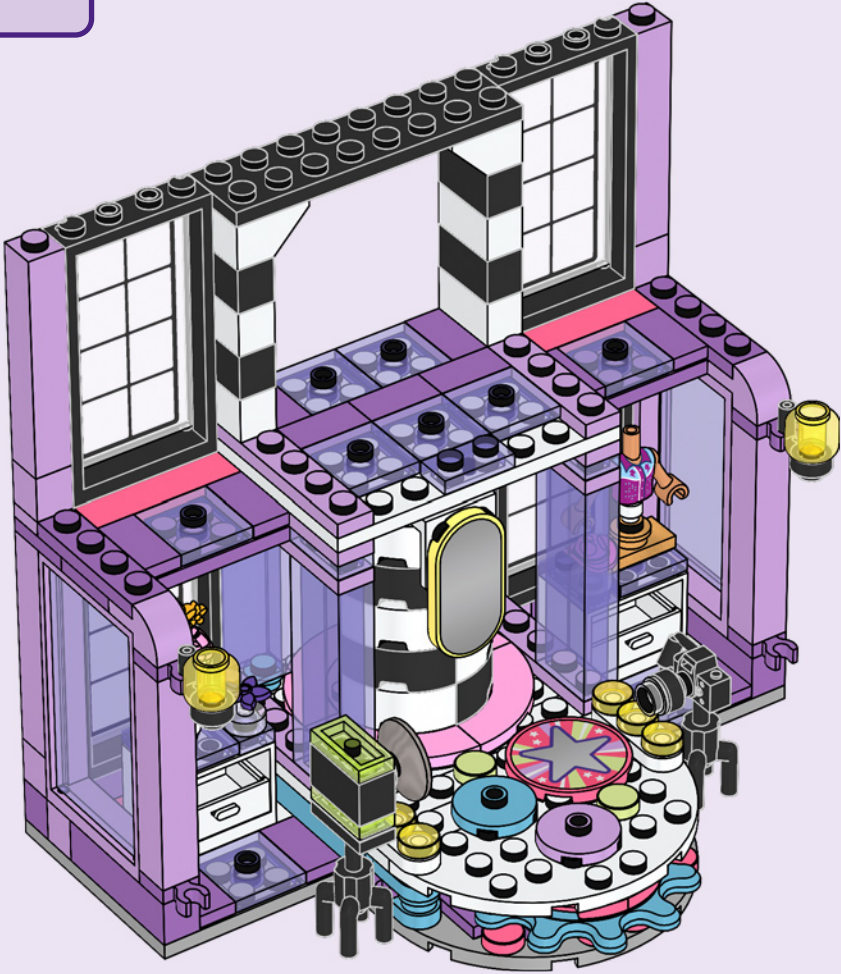

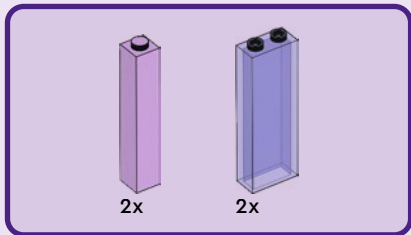

62

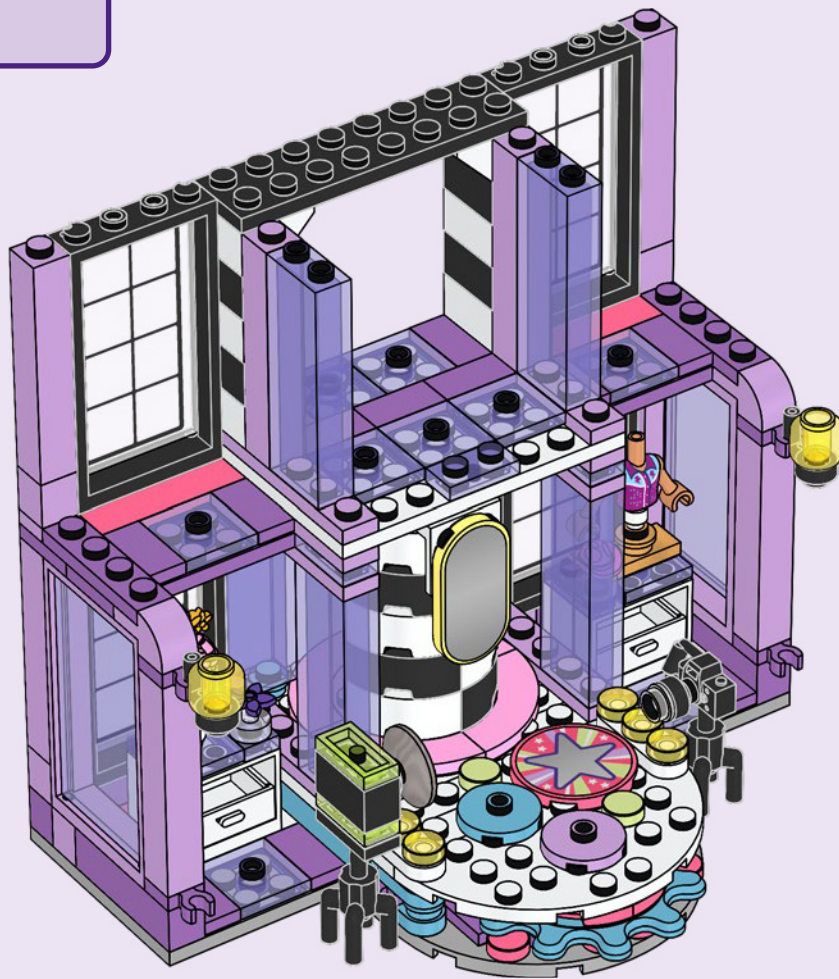



2x



2x

63

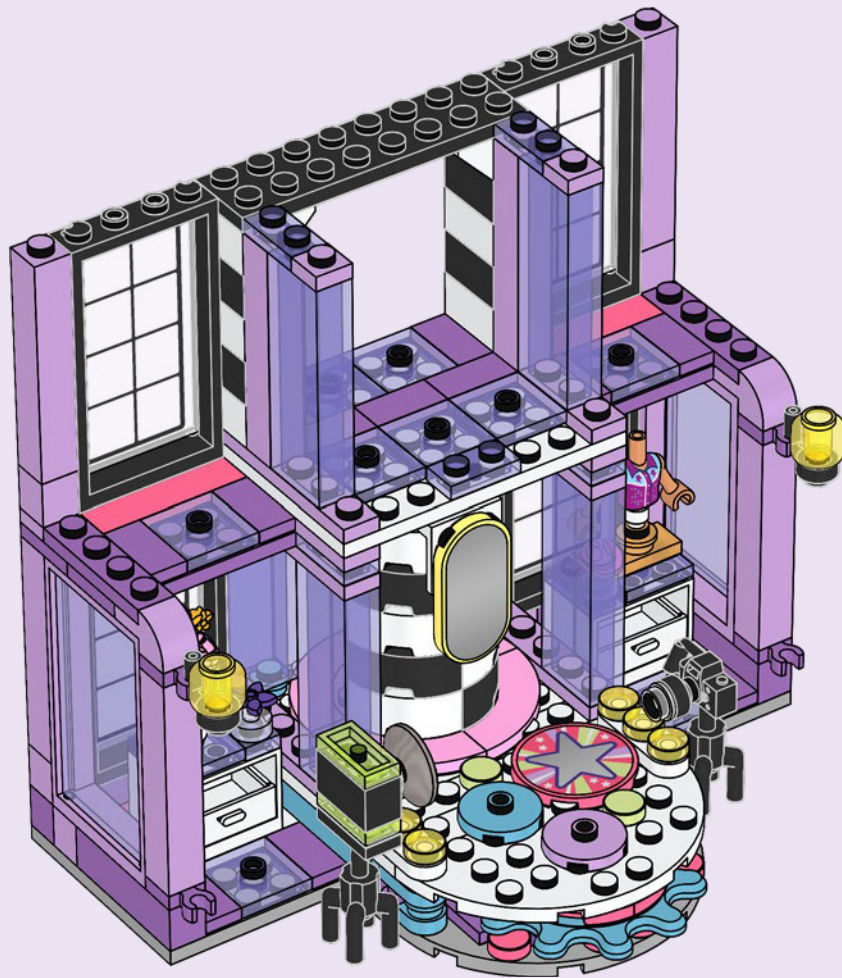

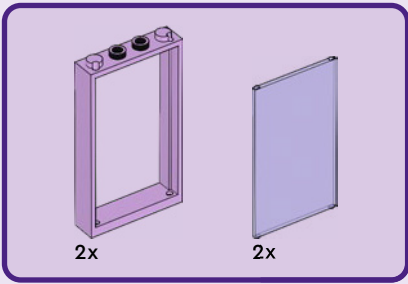

64

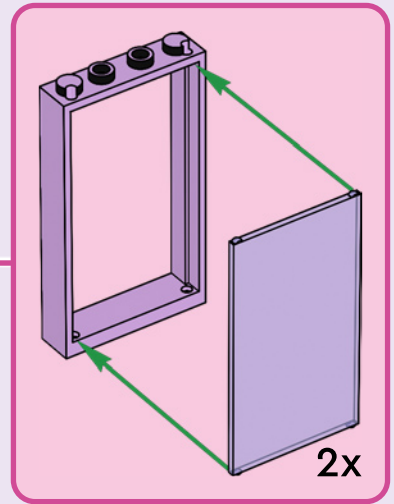
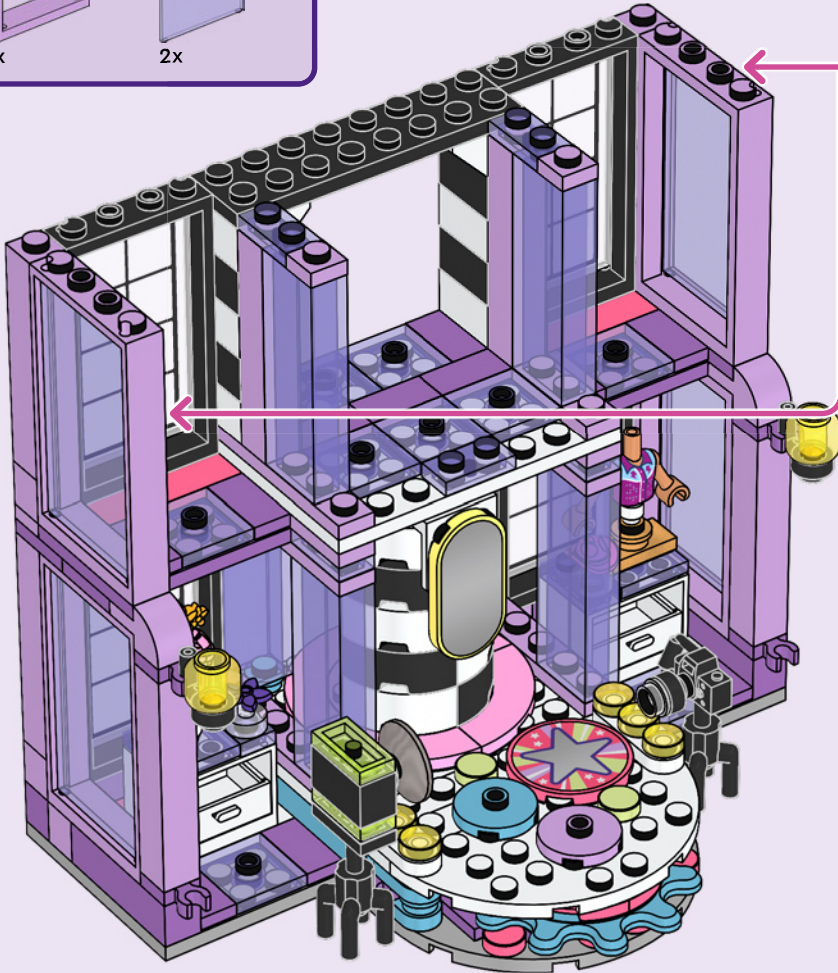

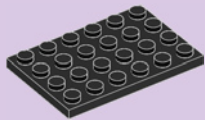

2x

65

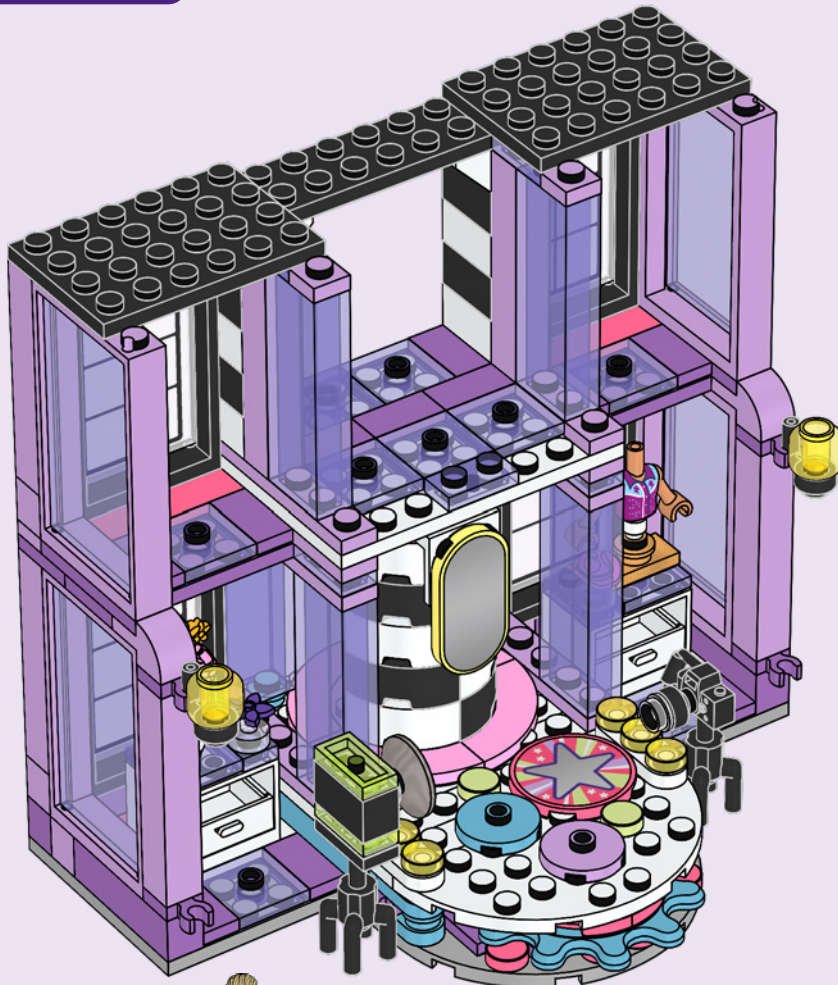

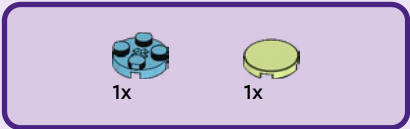

66

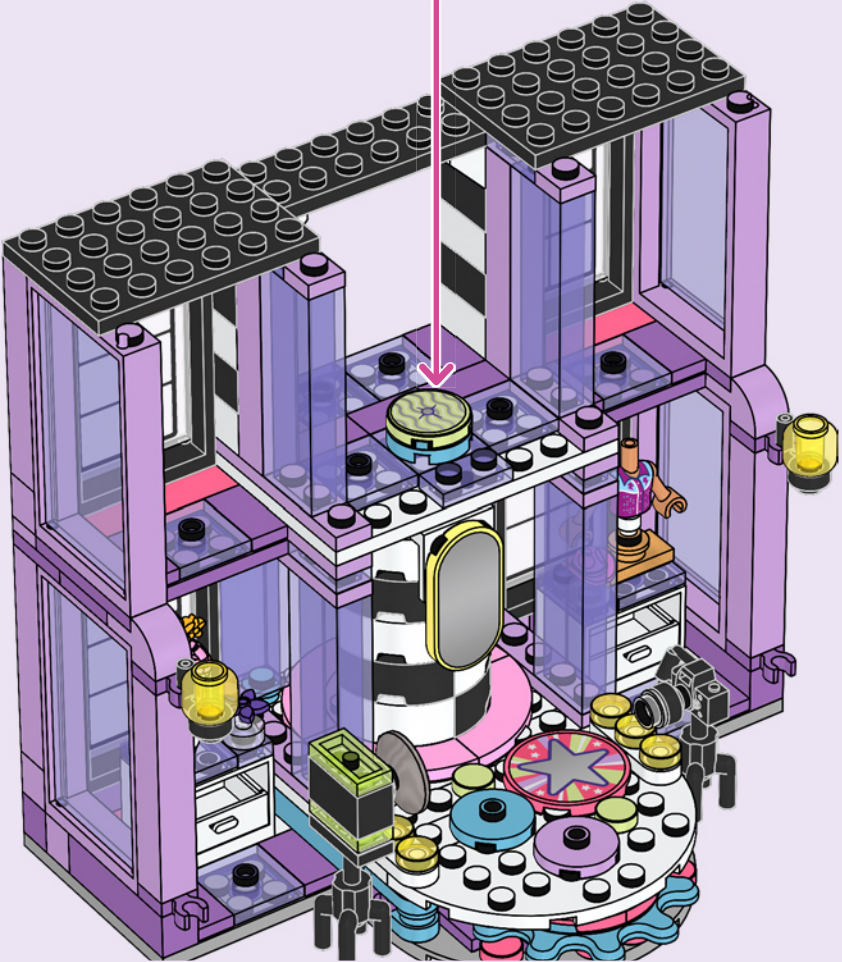
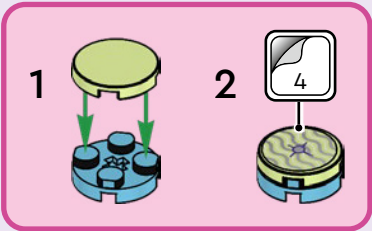



67

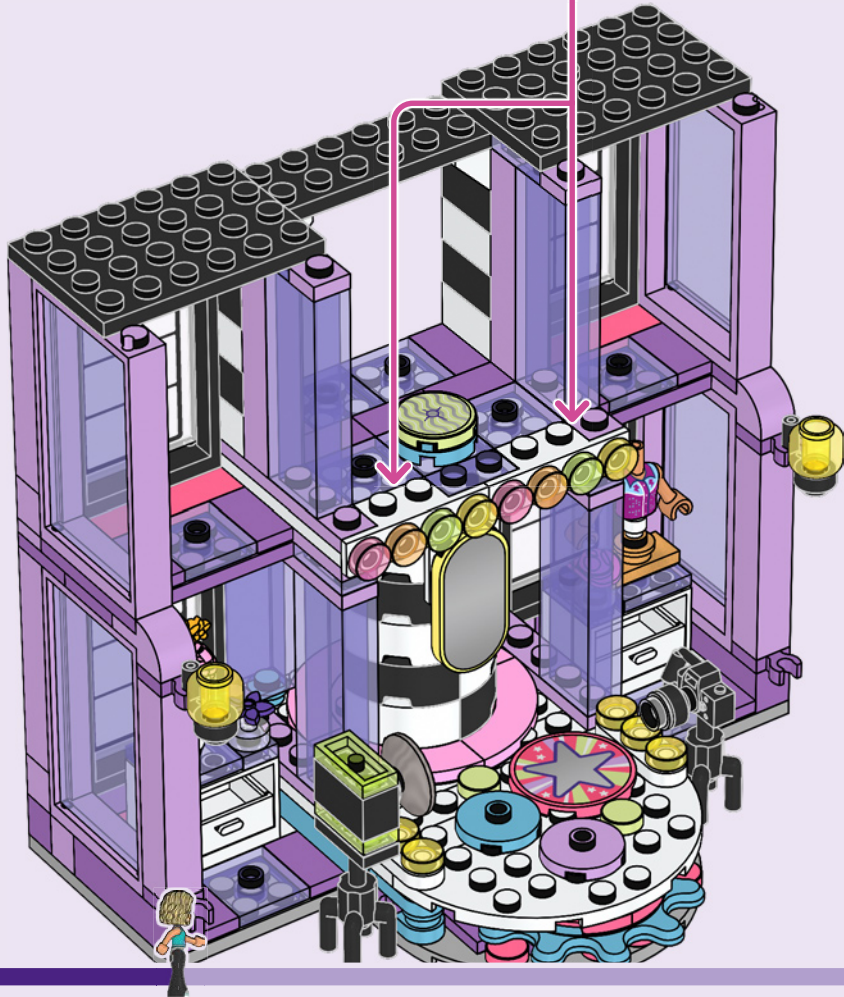
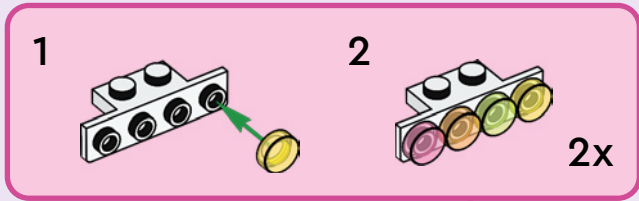



8x

68

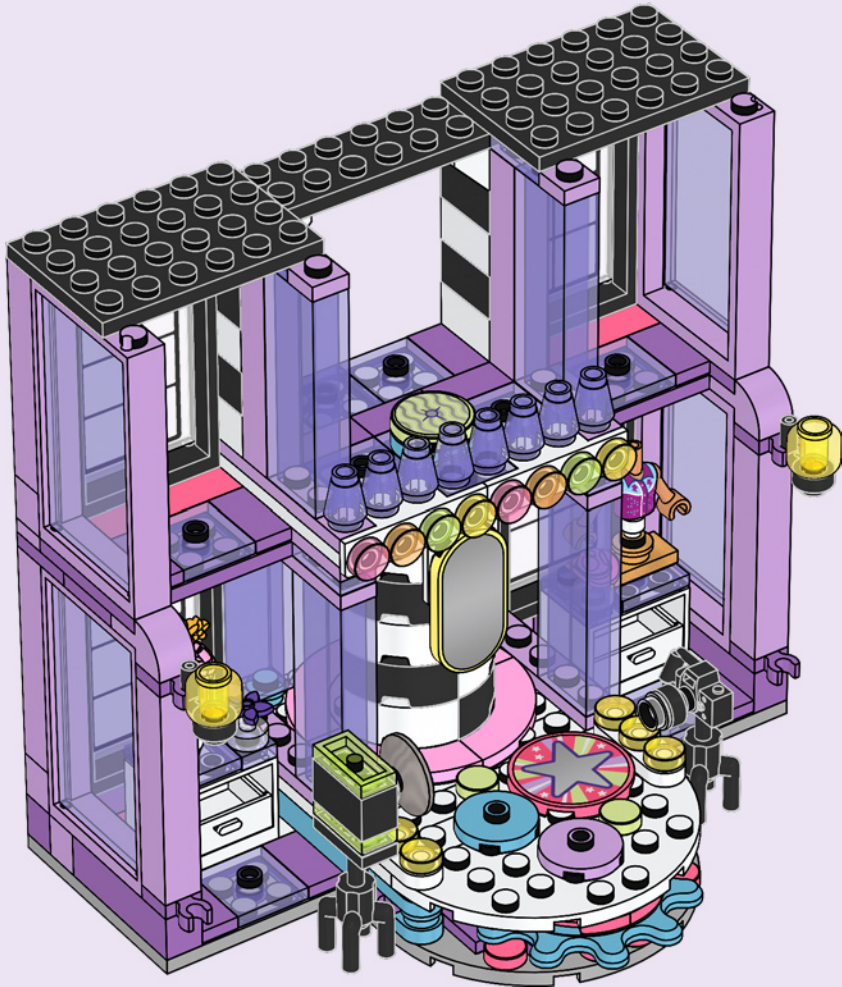



69

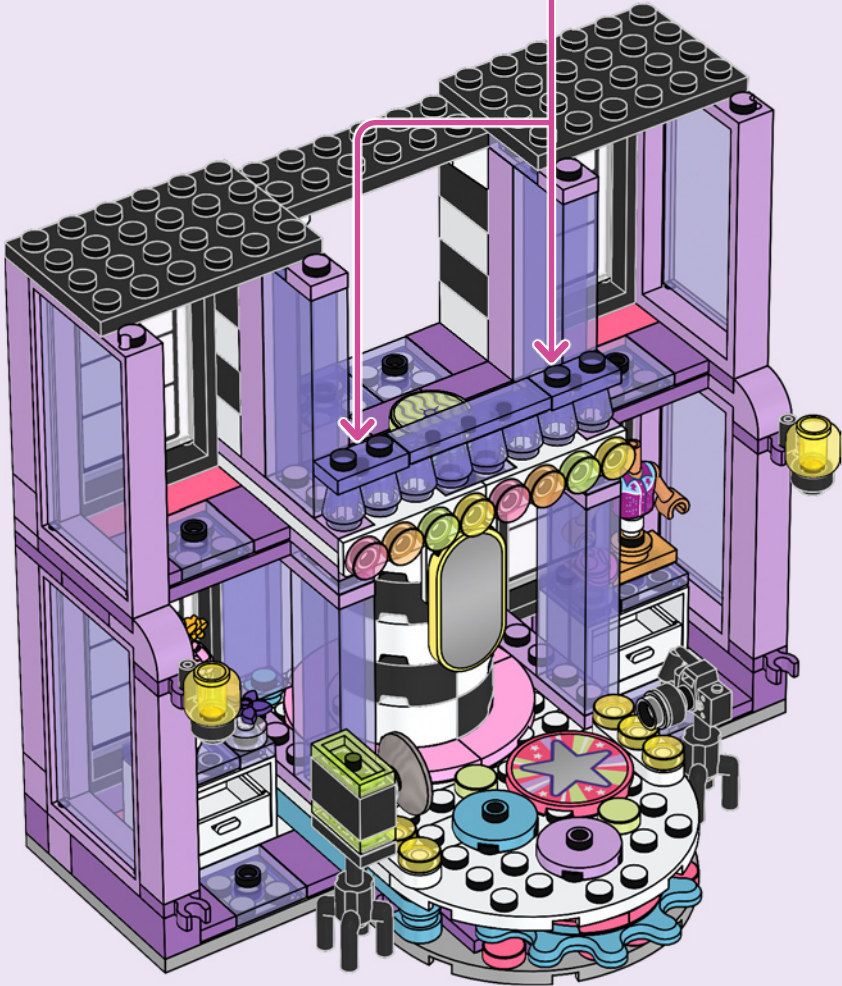

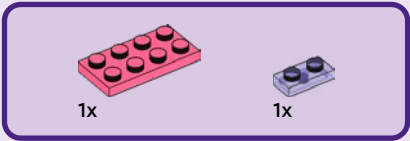

70

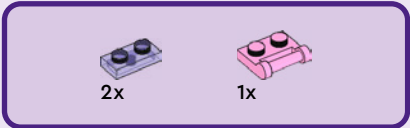
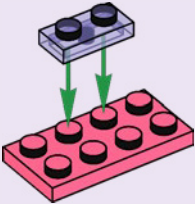

71

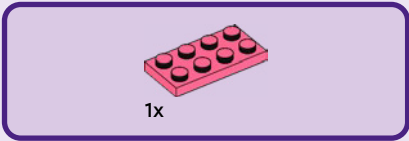

72

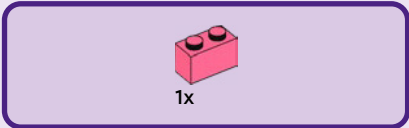

73

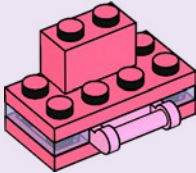

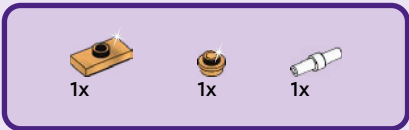

74

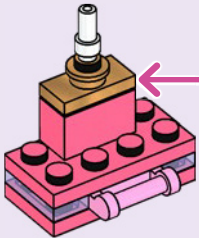
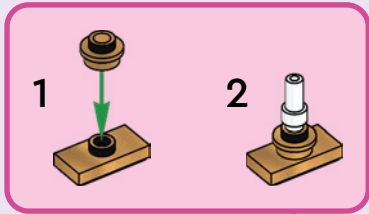

75

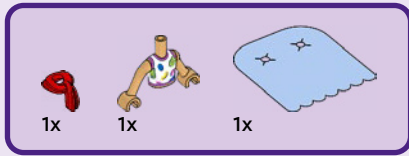
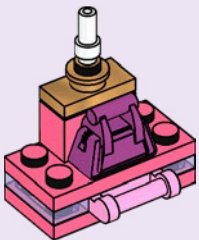

76

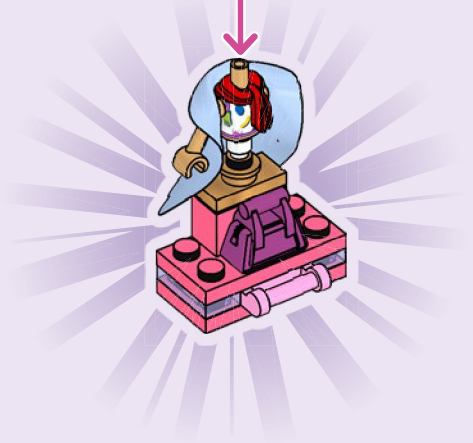
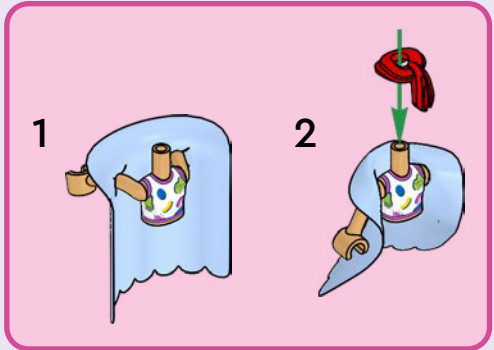

77

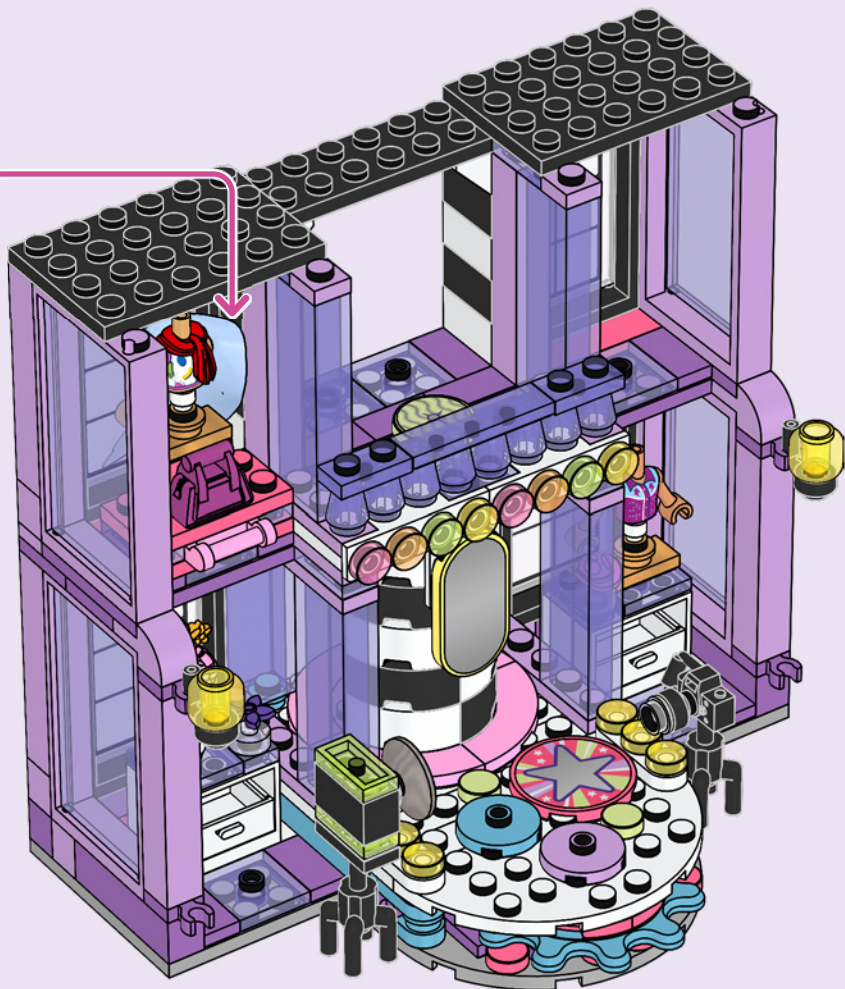

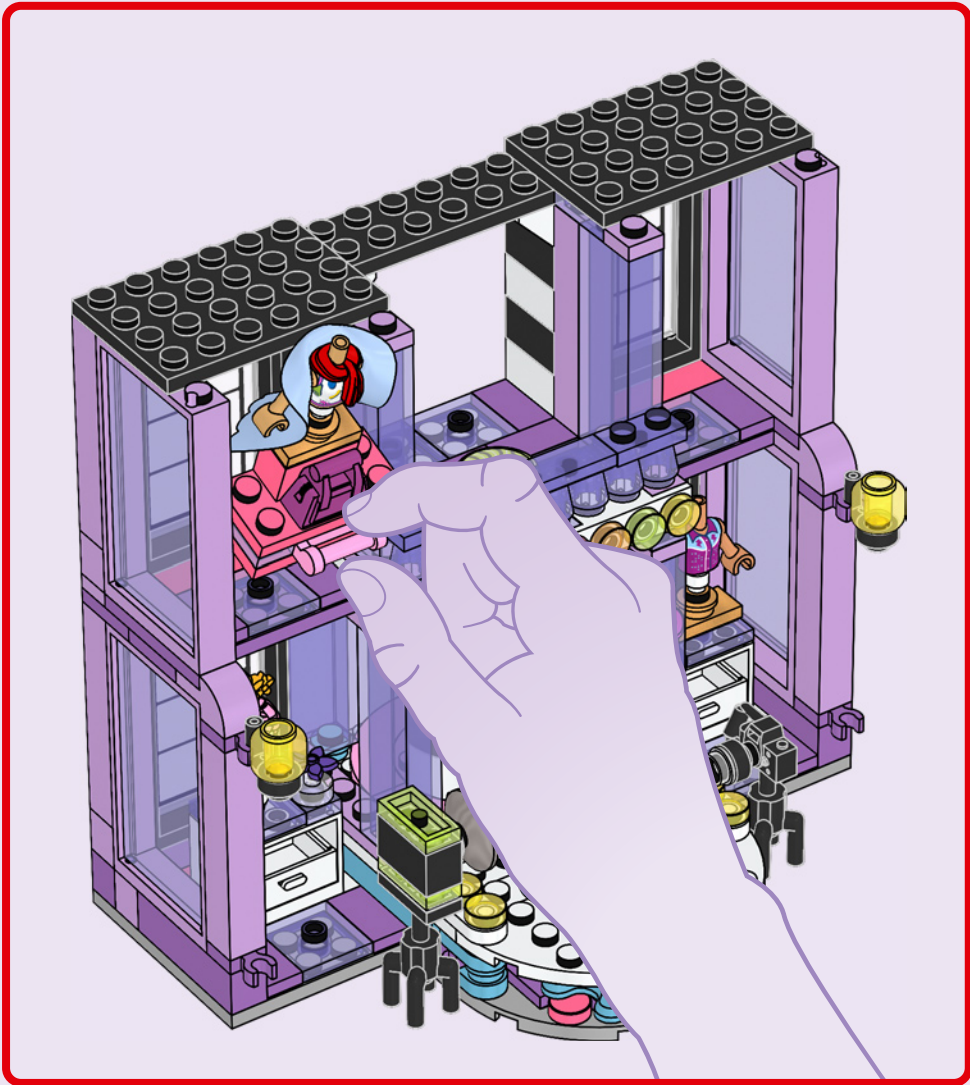

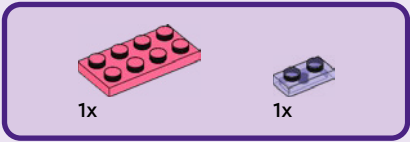

78

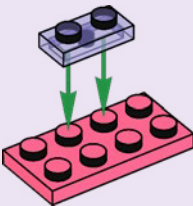

79

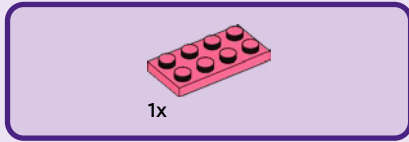

80

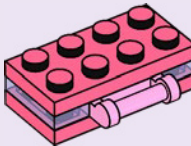

81

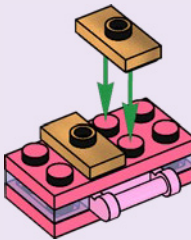

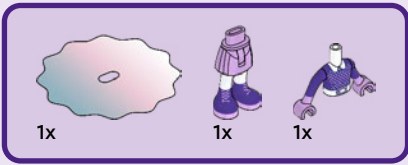

82

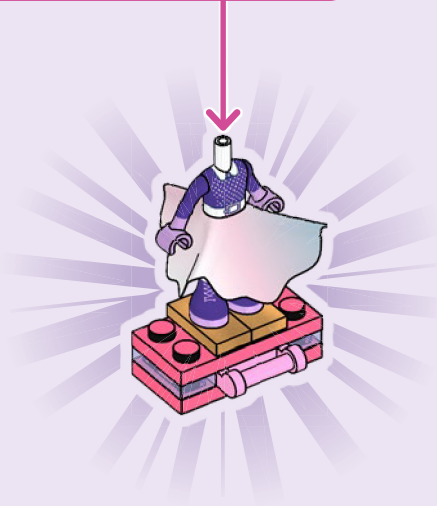
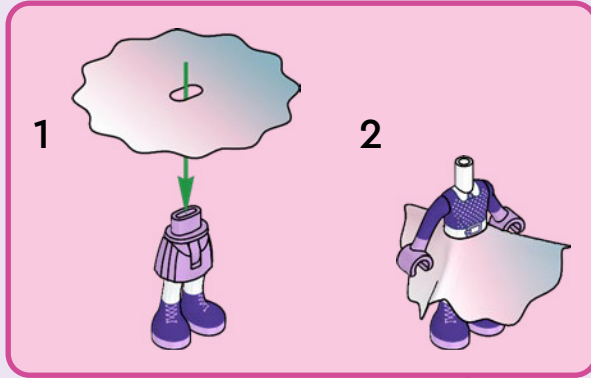

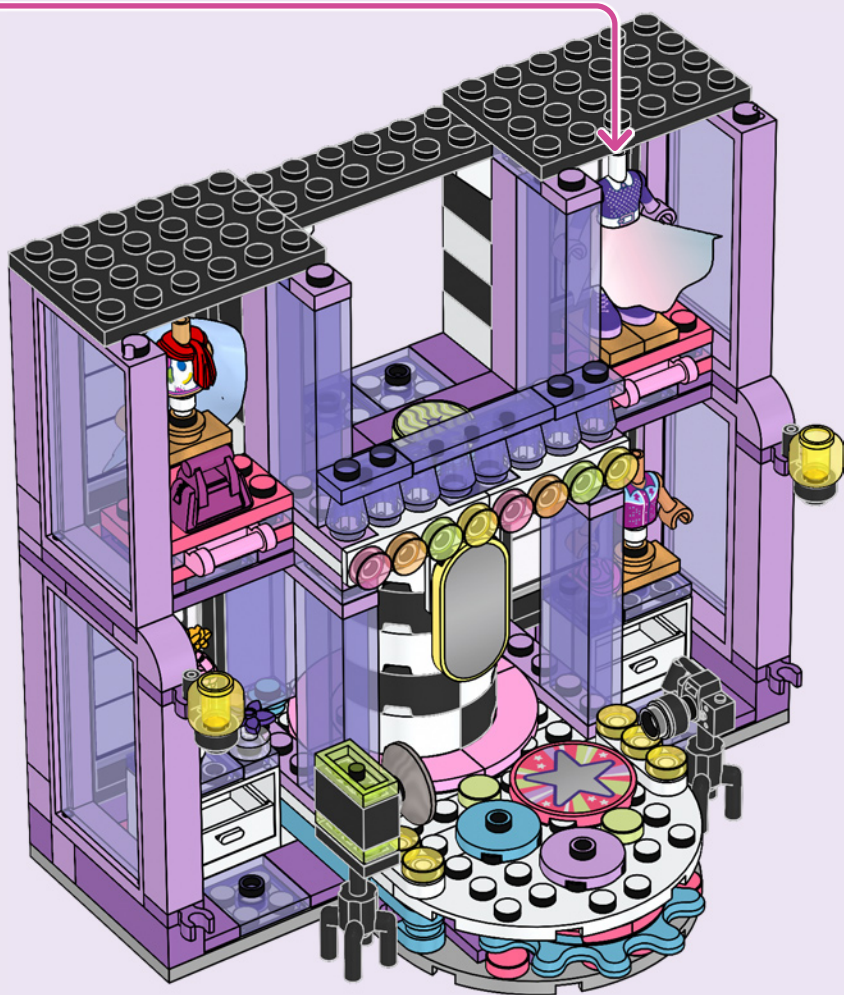

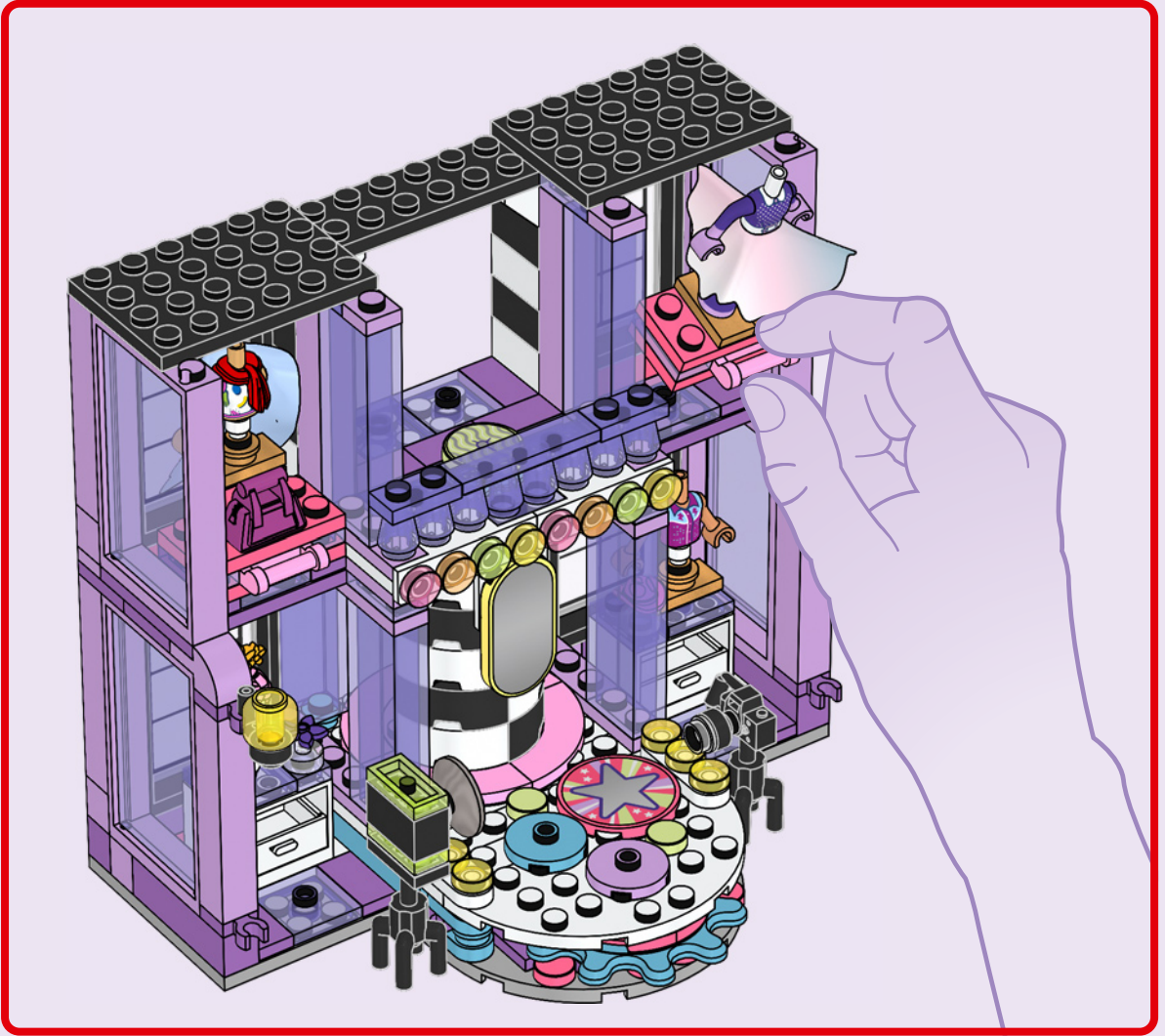

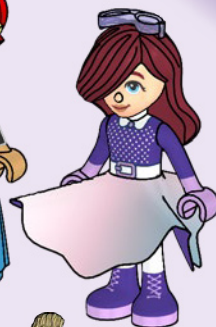



84

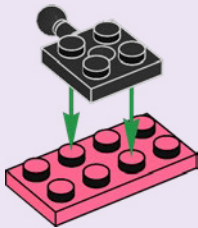

85

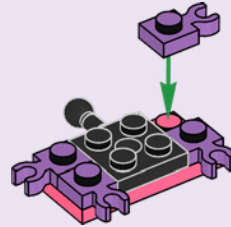

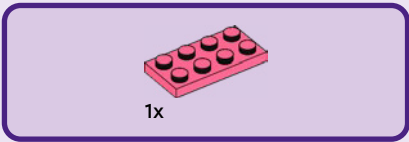

86

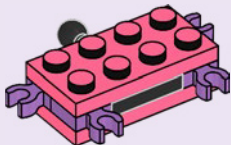

87

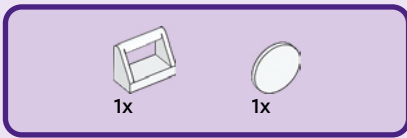
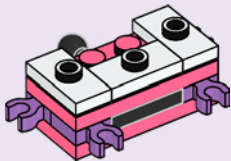

88

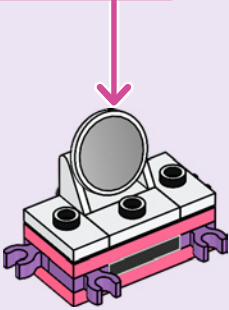
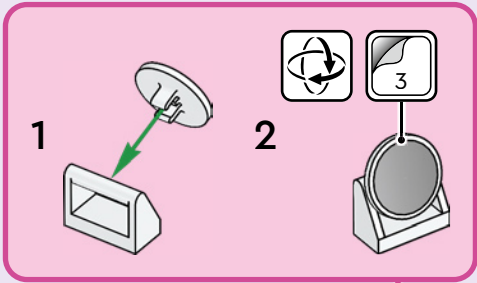



1x



1x

89

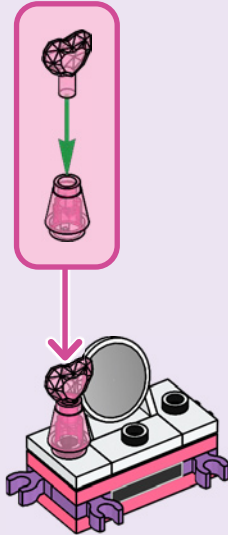

1x



1x

90

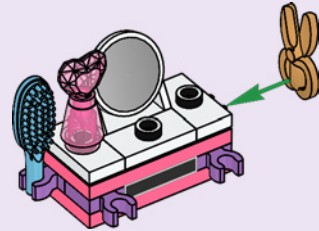

1x



1x

91



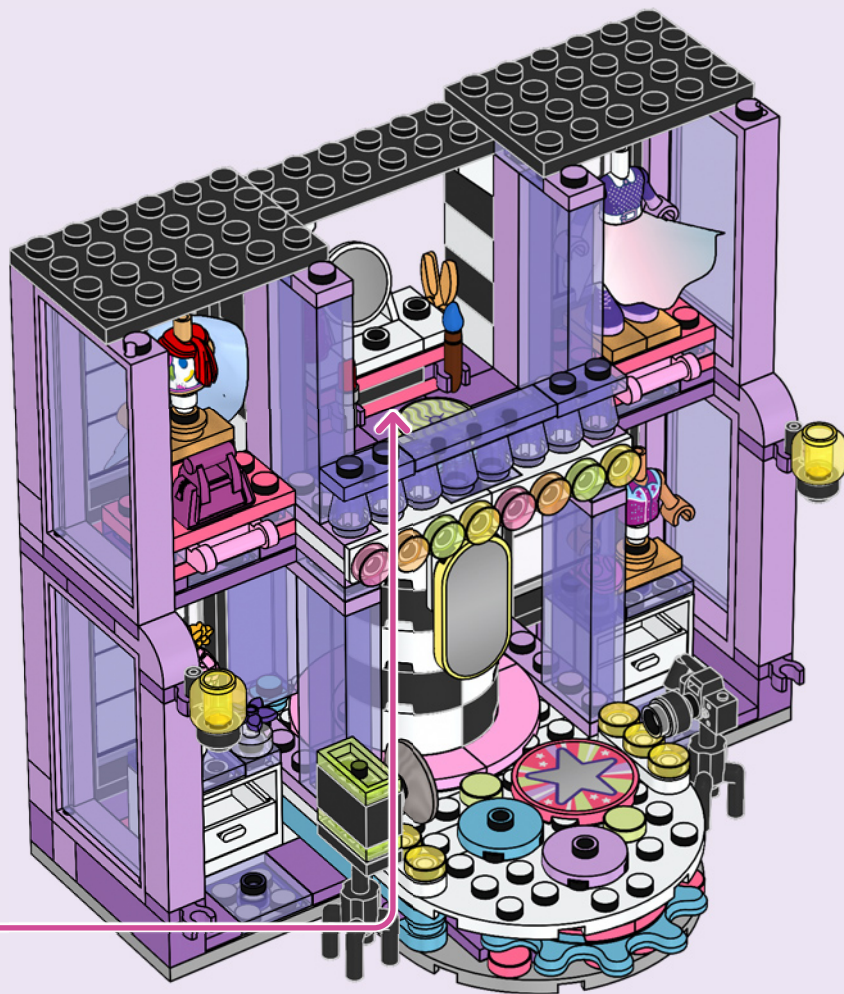

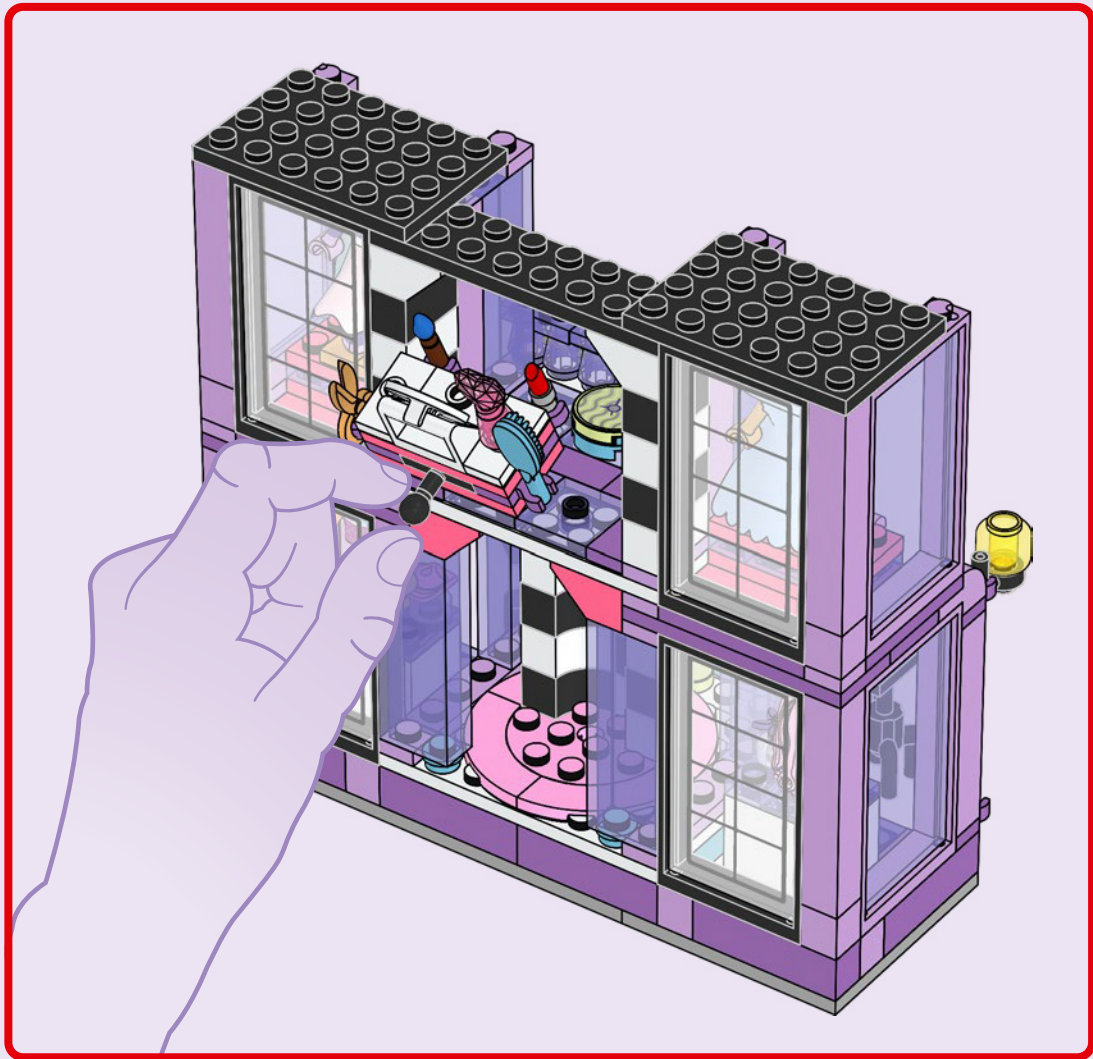



4x

93



4x

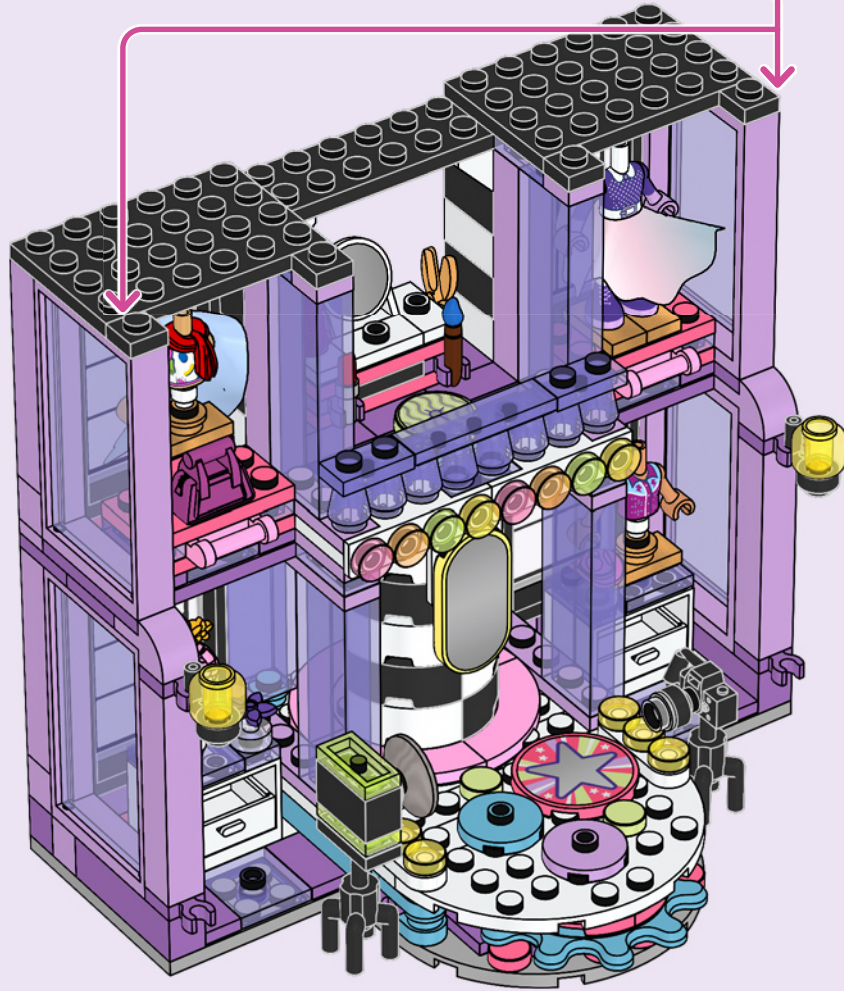



2x

94

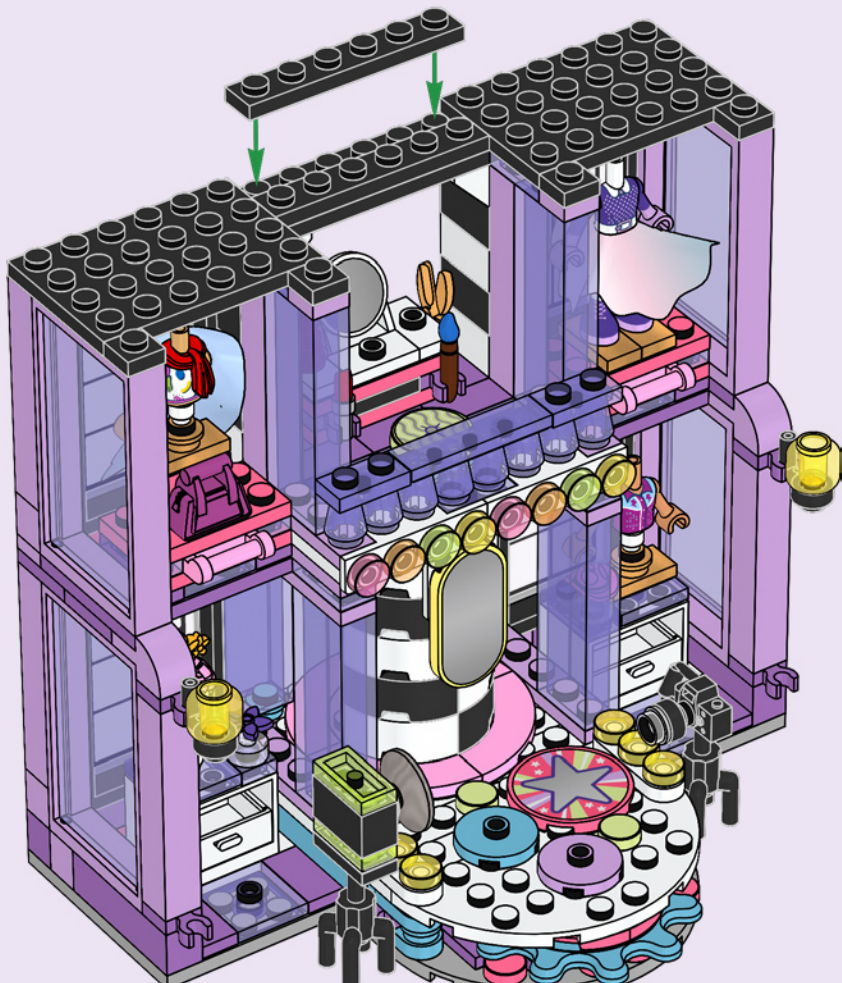

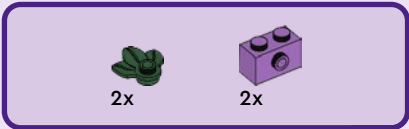

95

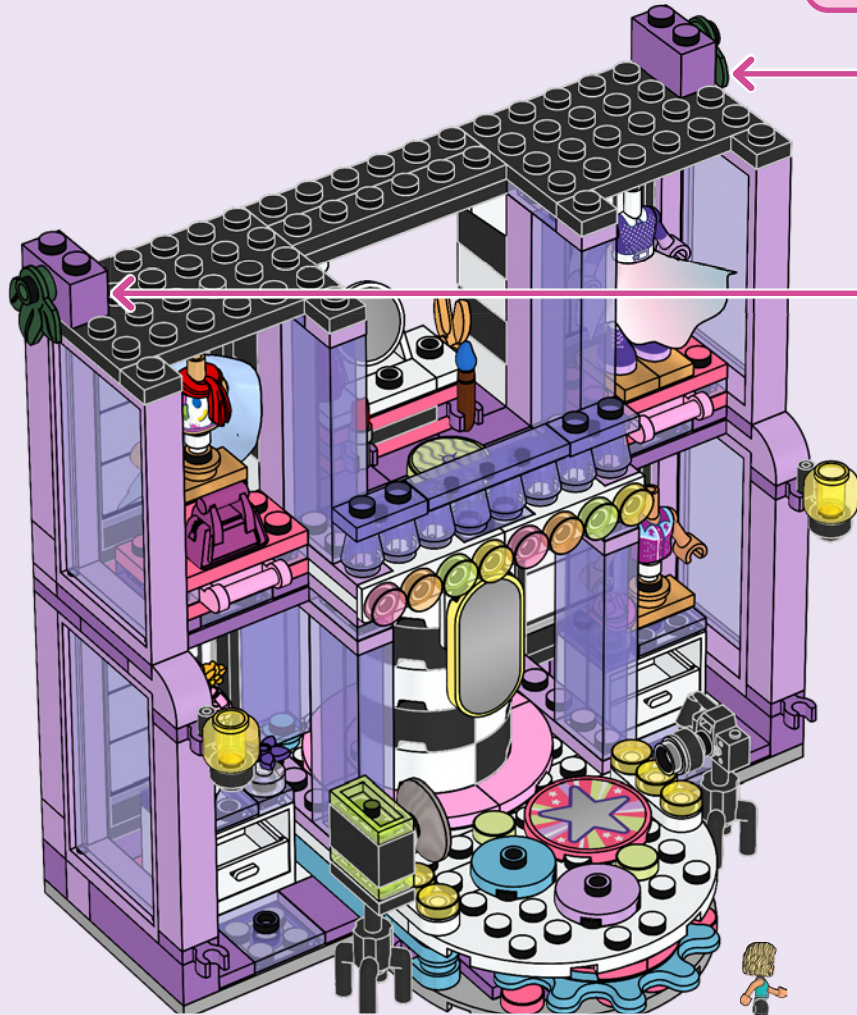
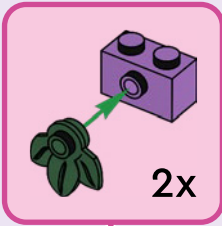

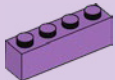

4x

96

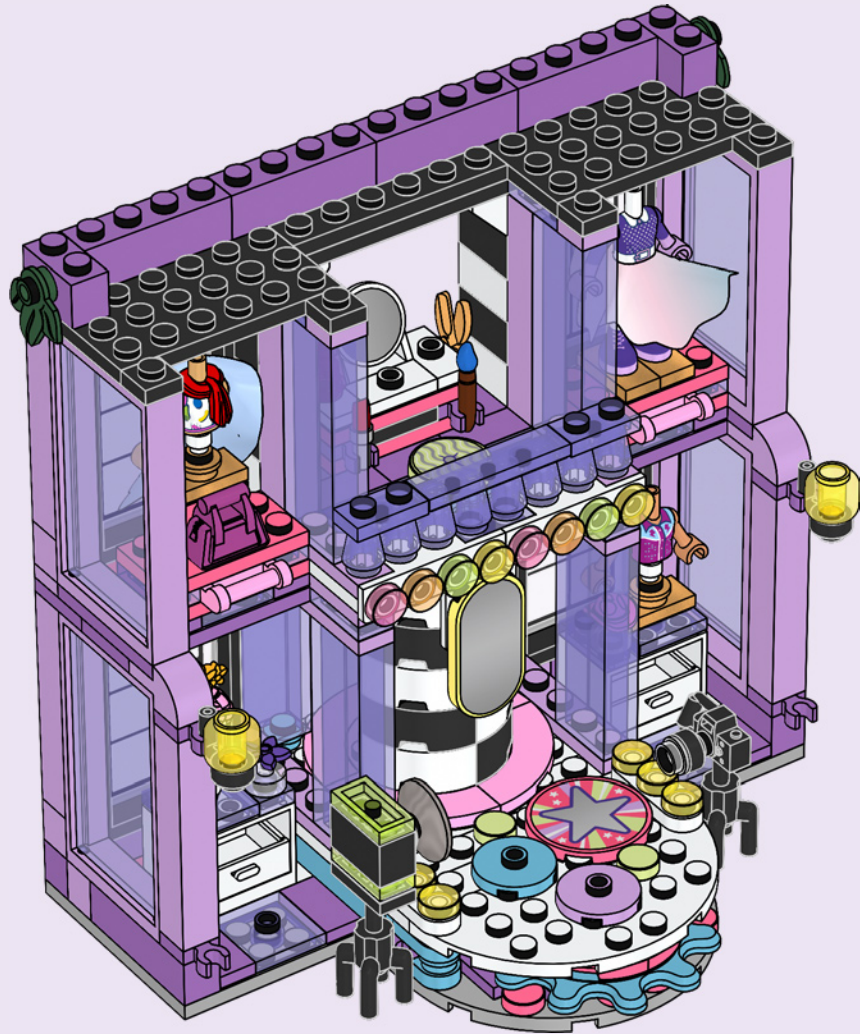

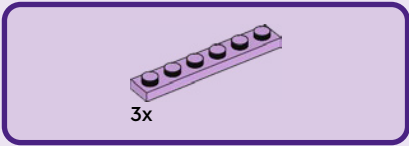

97

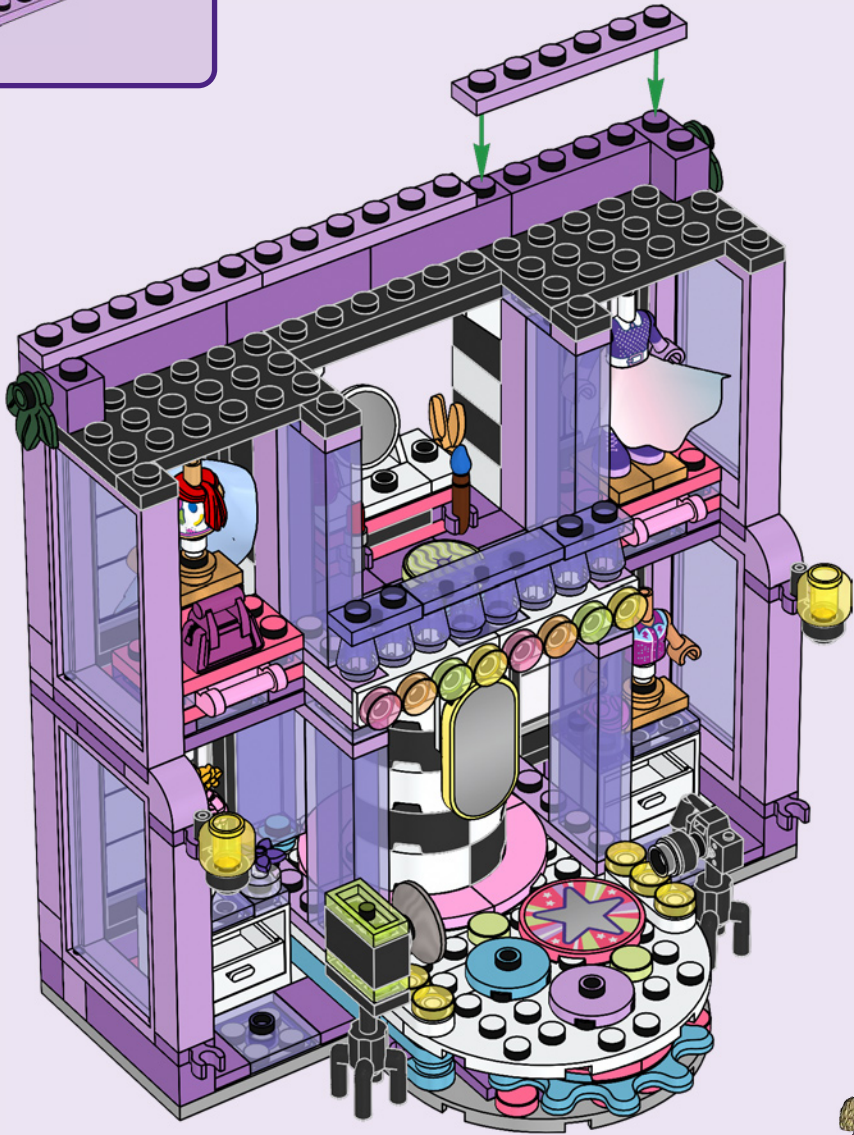



2x



2x



2x



4x



4x



4x



2x

98

1

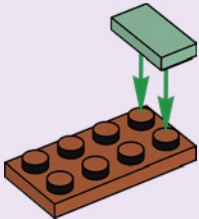

2

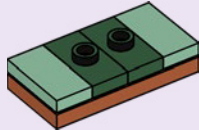

3

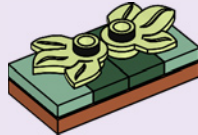

4



2x

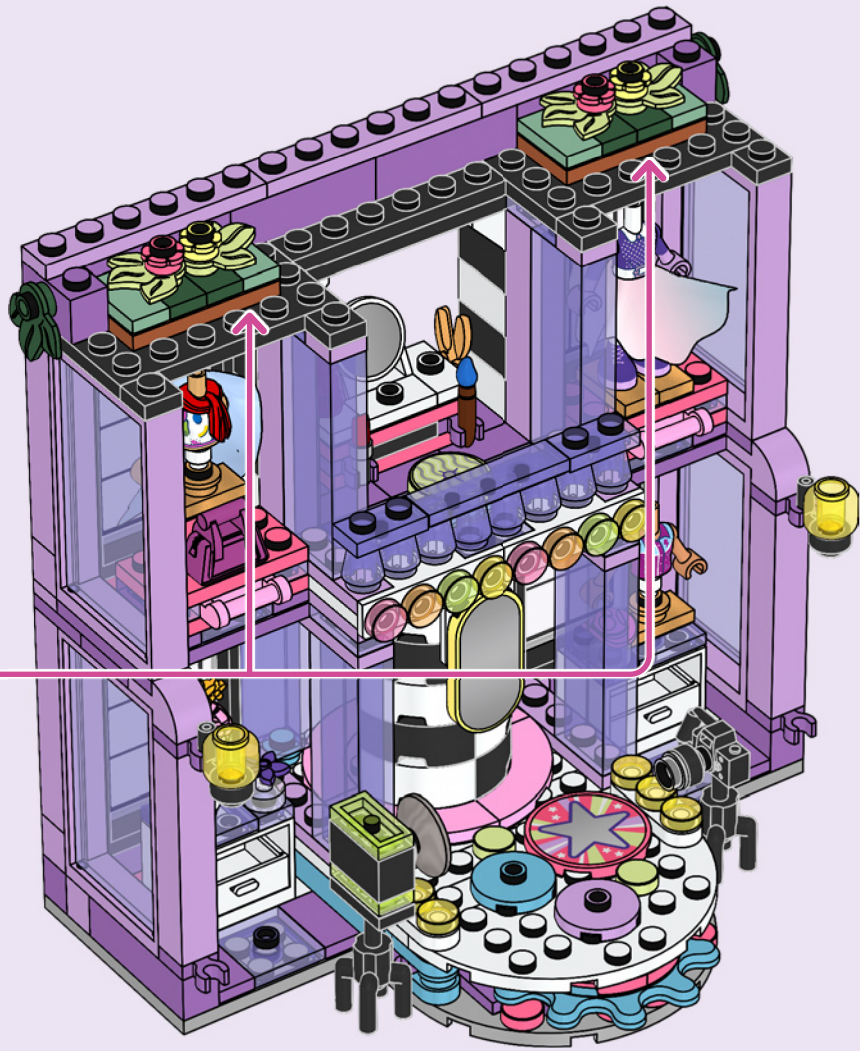



2x



1x

99

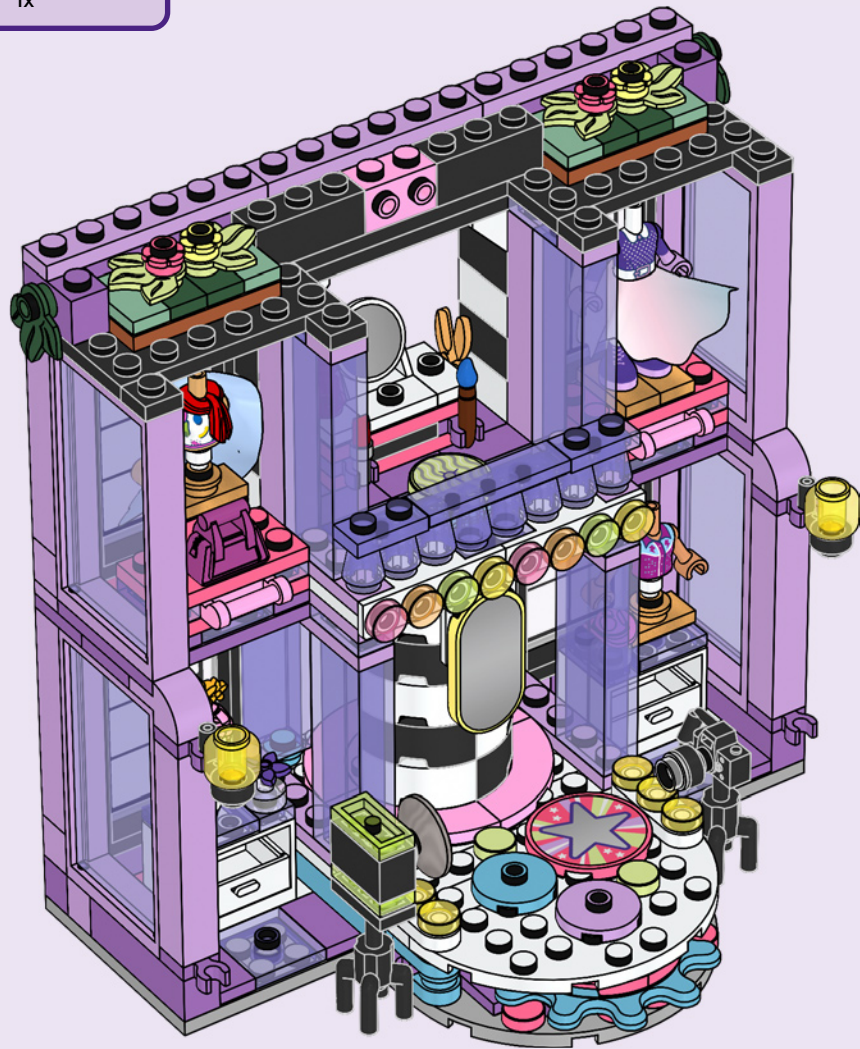

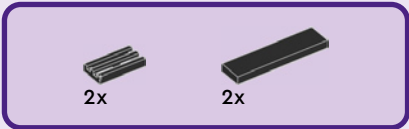

100

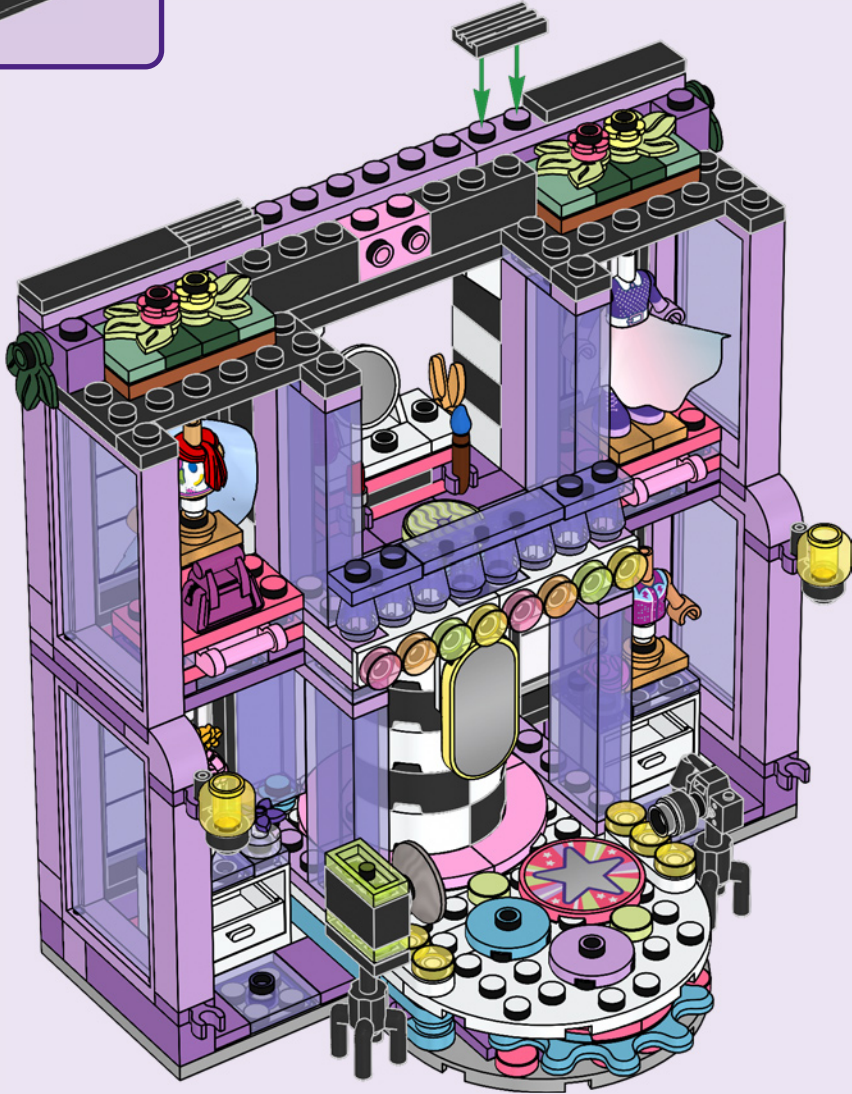



3x

101

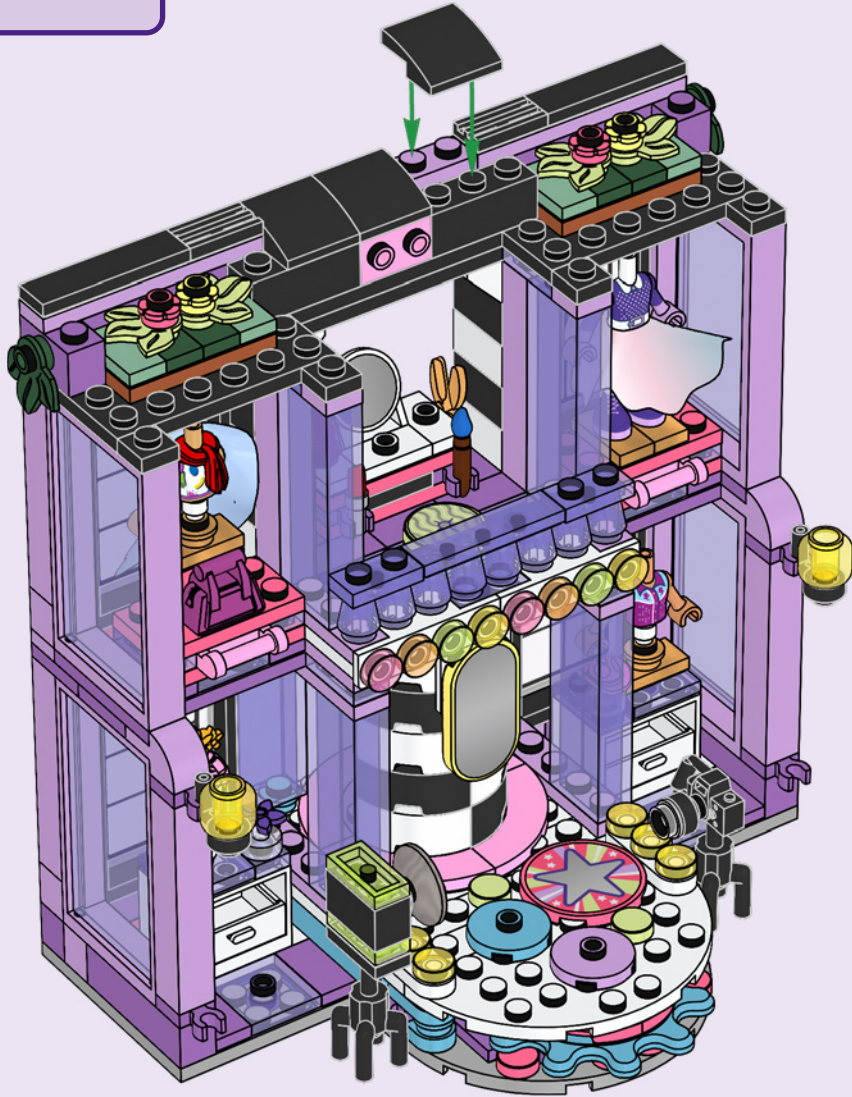

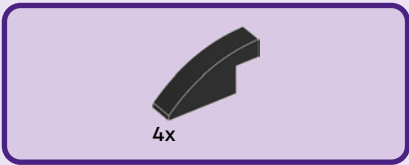

102

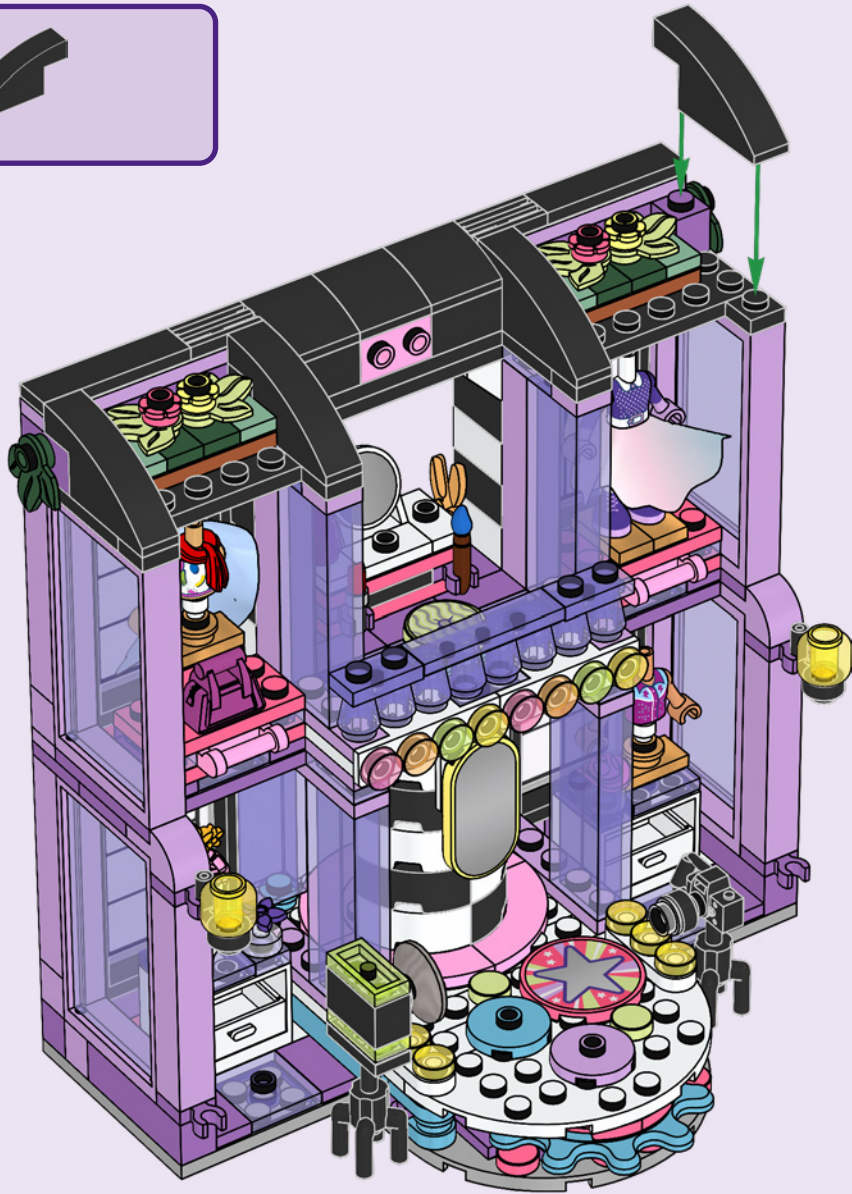

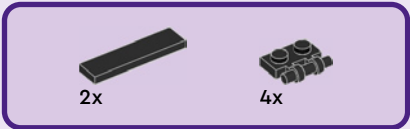

103

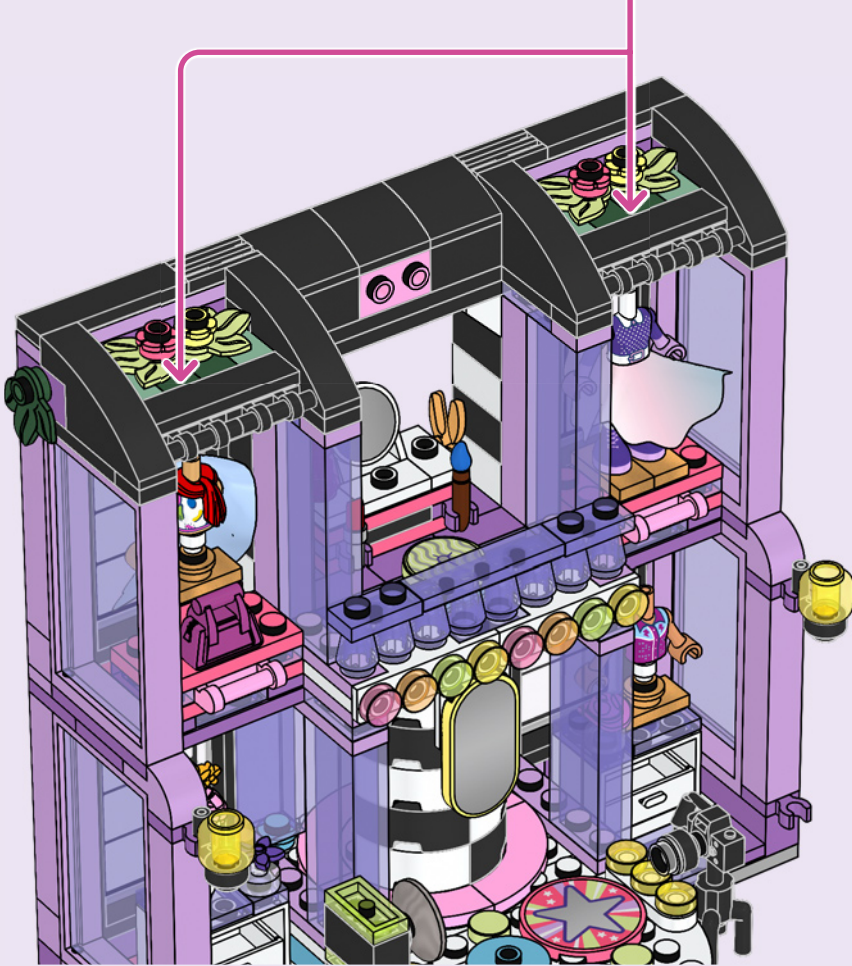
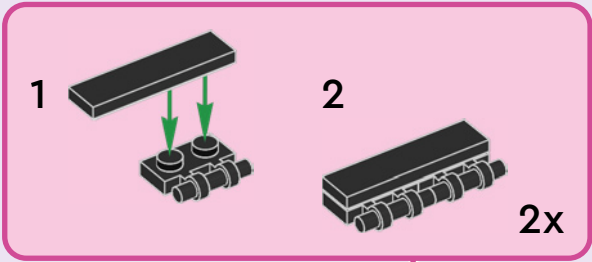

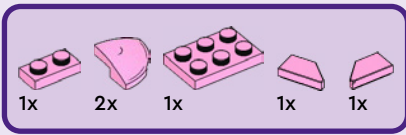

104

1

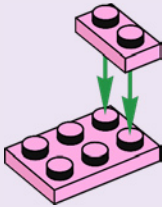

2

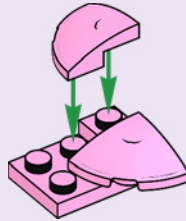

3



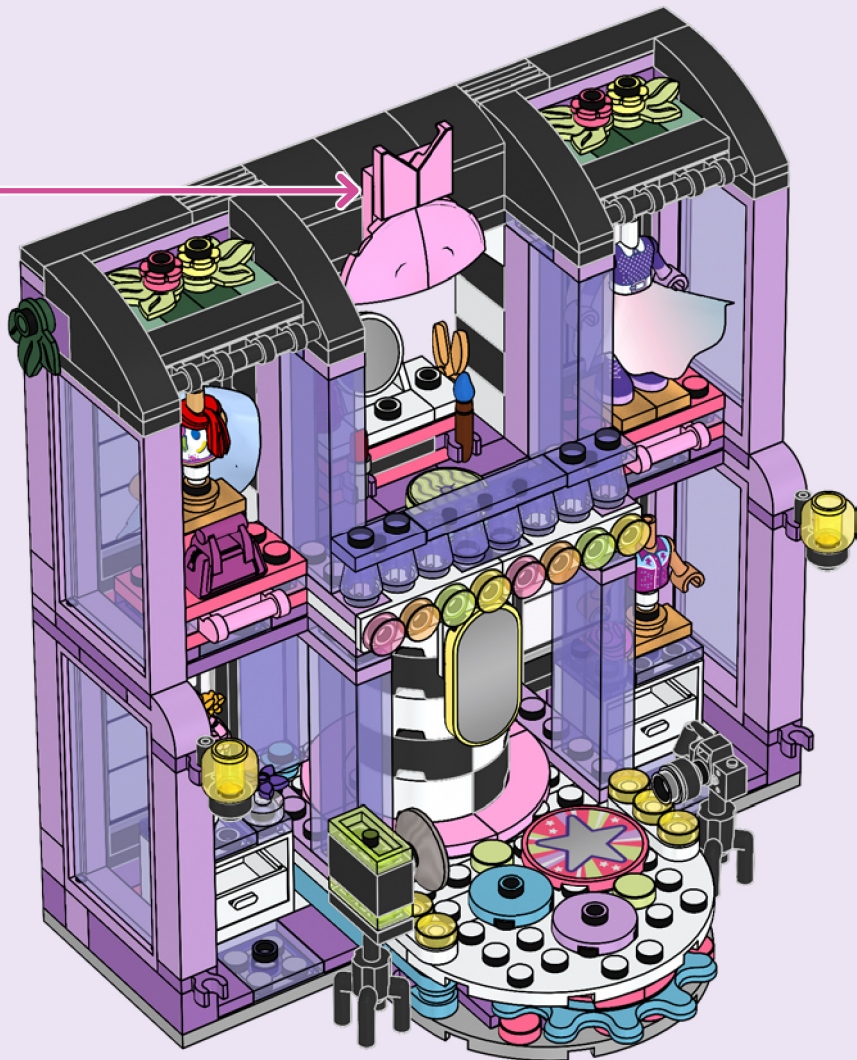





Friends

Watch
series
online



Watch series online / Schau dir die Serie online an / Regarde la série en ligne / Guarda la serie online / Mira la serie en Internet / Assistir à série online / 在线观看 / Oglądaj serial w internecie / Sleduj serial online / Pozri si serial online / Nézd a sorozatot online / Дивіться серіал онлайн / Vizionează serialul online / Глядайте серіала онлайн / Skaties seriālu tiešsaistē / Vaata sarja veebist / Žiūrėk serialą internetu

LEGO

Friends

42684



42687



42652



42695



42688



1x 306201	4x 6195371	1x 6587291	1x 6475339	2x 303226	8x 6514023	1x 6566683
1x 6454713	2x 4520636	1x 306221	1x 6568338	1x 303426	1x 6096991	1x 6396678
3x 6508268	2x 6168618	1x 6215539	4x 4140588	2x 4535928	16x 6514009	1x 6528712
1x 6317571	2x 4619665	1x 6574797	3x 6053077	5x 6514052	6x 6514089	1x 6258820
2x 6357680	2x 302001	1x 6499709	5x 4567436	5x 6507895	11x 6499142	1x 6353796
2x 306901	4x 346001	2x 6186675	1x 6448318	1x 6507895	11x 6499142	1x 4211406
4x 300401	1x 346001	4x 302426	2x 362226	4x 6584316	4x 6581494	1x 4211474
1x 243201	1x 6138699	2x 6508269	4x 243126	8x 6514193	1x 6510186	1x 4211400
3x 6051511	1x 303601	2x 4532220	4x 6509390	2x 6513997	2x 6400754	1x 4211474
1x 6117940	1x 6450820	1x 6575327	1x 6476480	1x 6514026	4x 6192250	1x 4211400
2x 6450820	2x 6366391	1x 6476480	4x 300426	2x 6514196	4x 4616578	1x 6587604
2x 6366391	3x 6536567	4x 300426	2x 241226	1x 6240042	1x 6409769	1x 6070302
3x 6536567	5x 4567449	2x 241226	1x 6092585	1x 6395609	2x 6514197	1x 6307633
5x 4567449	1x 6585470	1x 6092585	2x 366626	1x 6395609	1x 6567386	1x 6587197

1x
6096990

1x
6545181

1x
6585162

2x
6578897

1x
6542398

1x
6353192

1x
4654128

2x
6568115

1x
6102999

1x
6543502

4x
6468509

2x
6426463

3x
6195266

1x
6286832

1x
6363809

1x
6580723

2x
6030534

1x
6582830

1x
6416490

1x
6469304

2x
6190252

1x
6489198

4x
6092594

2x
6514198

2x
6514011

1x
6584318

4x
6102986

1x
6058368

4x
6396673

1x
6109752

1x
6136419

2x
6271207

1x
6238331

2x
6022000

10x
6543488

19x
6152645

2x
6537998

1x
6517196

1x
6344844

10x
6107188

4x
4619524

4x
4625027

8x
6097053

4x
6099363

8x
6099351

1x
6585477

1x
6223598

2x
6543251

1x
6586604

4x
6344416

11x
6204071

2x
6284598

3x
6546464

1x
6223506

4x
6541652

3x
6424480

1x
6528623

4x
6311436

2x
6295242

2x
6467785

1x
6258572

6x
6250024

1x
6544449

8x
6258570

6x
6305455

1x
6416546

1x
6528290

1x
6585366



[LEGO.com/service](https://www.lego.com/service)

YOU COULD

WIN

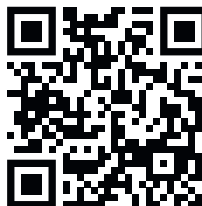

Scan this QR code or go to
LEGO.COM/PRODUCTFEEDBACK and give us
your short feedback about this LEGO® set
for a chance to win a cool LEGO prize.

Terms and Conditions apply*

EN: YOU COULD WIN. Terms and Conditions apply* **DE: Du könntest GEWINNEN.** Es gelten die Teilnahmebedingungen* **FR: Tu pourrais GAGNER.** Des conditions s'appliquent* **IT: Potresti VINCERE tu.** Termini e condizioni sono applicabili* **ES: Puedes GANAR.** Aplican términos y condiciones* **PT: PODERÁ GANHAR.** Aplicam-se Termos e Condições* **ZH: 轻松获奖. 条款和条件适用*** **PL: Szansa na WYGRANĄ.** Obowiązuje regulamin* **CS: Máte šanci VYHRÁT.** Platí všeobecné smluvní podmínky* **SK: Máte šancu VYHRAŤ.** Platia všeobecné zmluvné podmienky* **HU: TE IS NYERHETSZ.** Felhasználási feltételek érvényesek* **UA: ВИ МОЖЕТЕ ВИГРАТИ.** Застосовуються загальні положення та умови* **RO: Ai putea CÂȘTIGA.** Se aplică termeni și condiții* **BG: Можете да СПЕЧЕЛИТЕ.** Има определени правила и условия* **LV: Tu vari LAIMĒT.** Ir spēkā noteikumi un nosacījumi.* **ET: Sul on võimalus VÕITA.** Kehtivad tingimused* **LT: Jūs galite LAIMĖTI.** Taikomos sąlygos*
**LEGO.com/productfeedback-terms*

LEGO, the LEGO logo and the FRIENDS logo are trademarks of the LEGO Group.
©2026 The LEGO Group.