



# Friends

42686



3

4

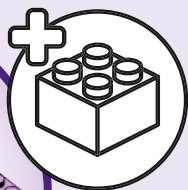
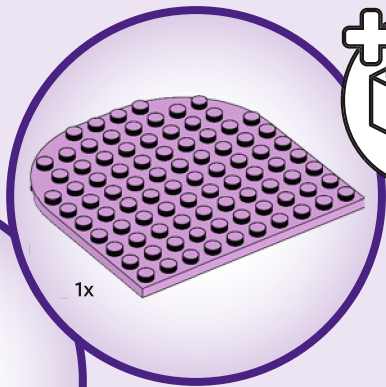

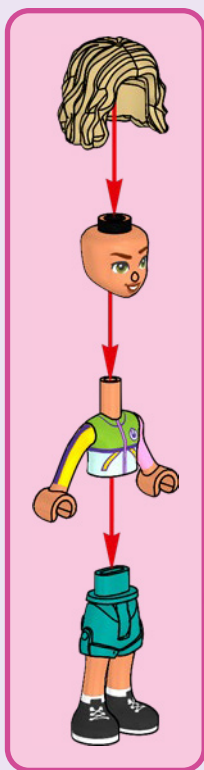

# Nova



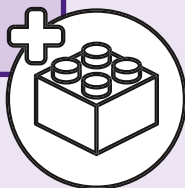
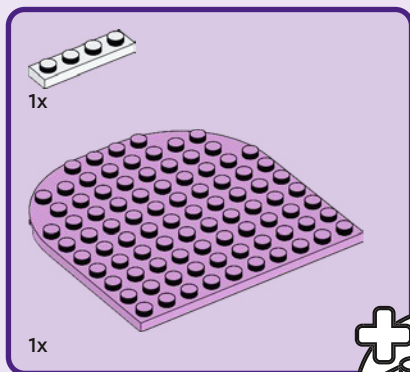

1

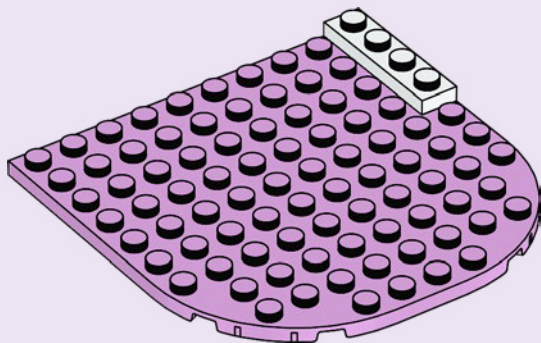



2x



2x

2

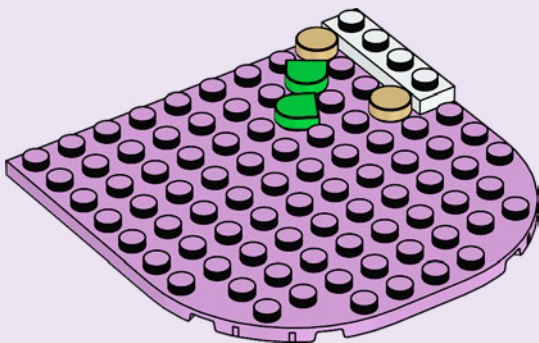

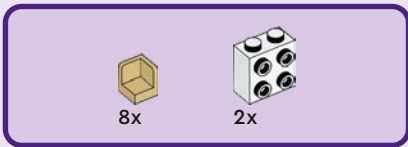

3

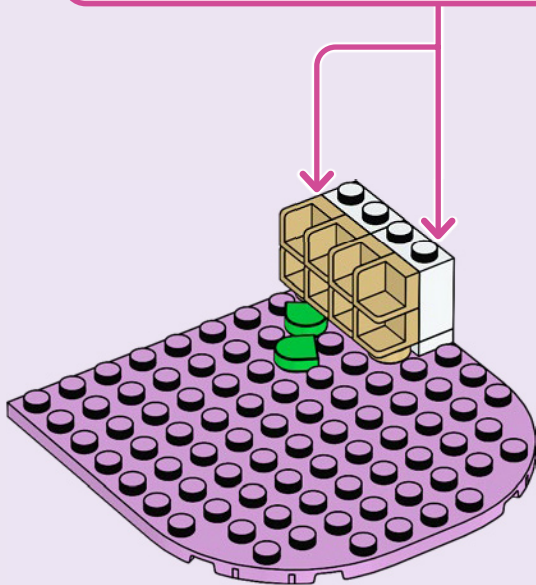
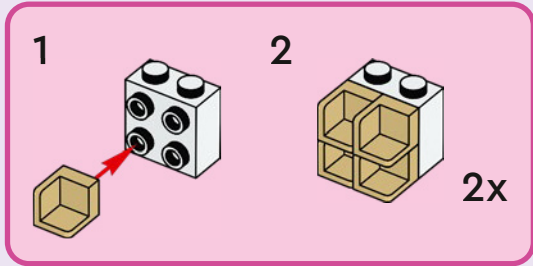

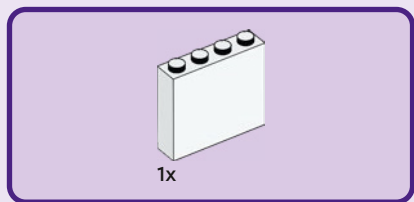

4

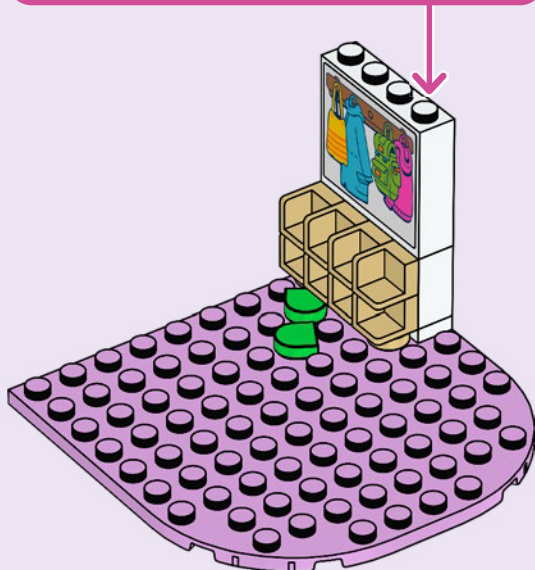
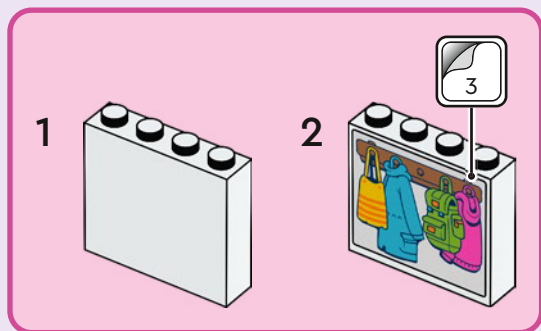



2x

5

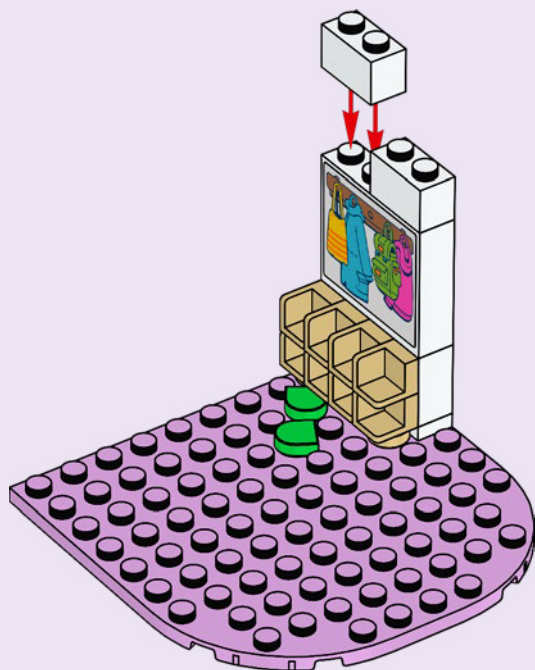

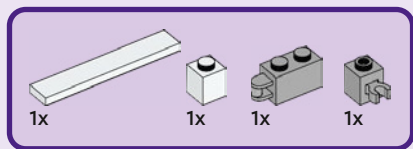

6



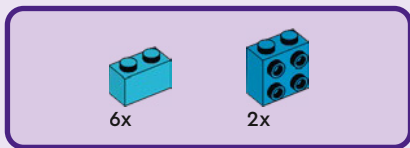

7

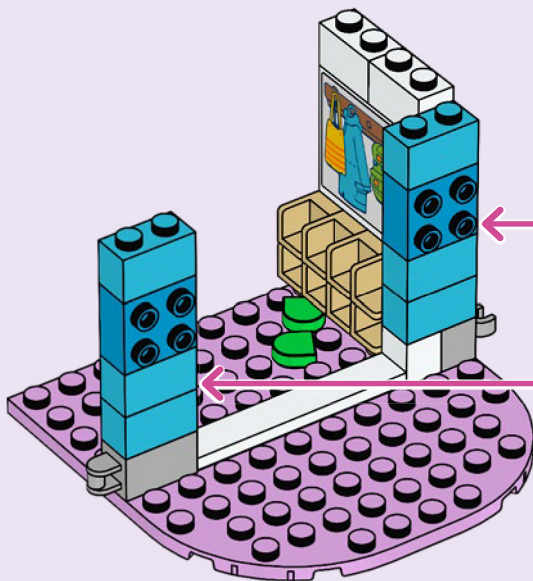
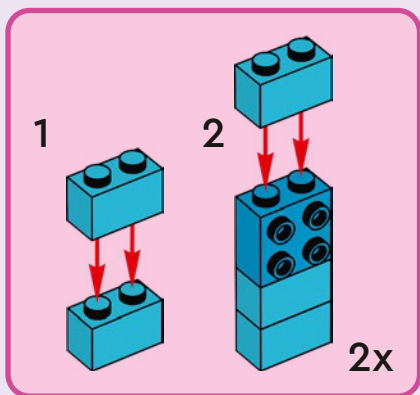



1x

8

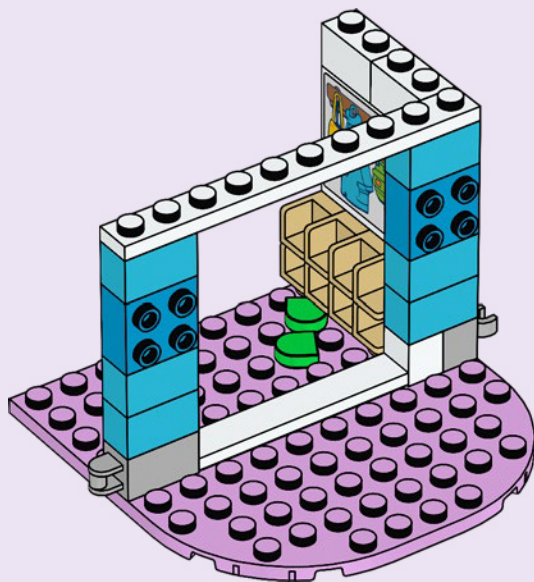



2x



2x

9

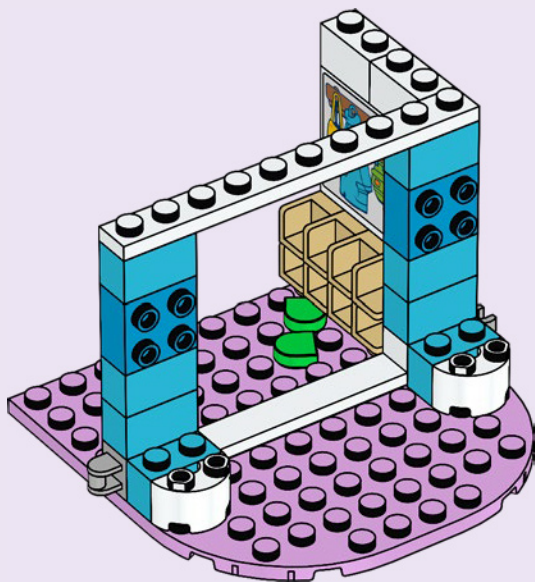



2x

10

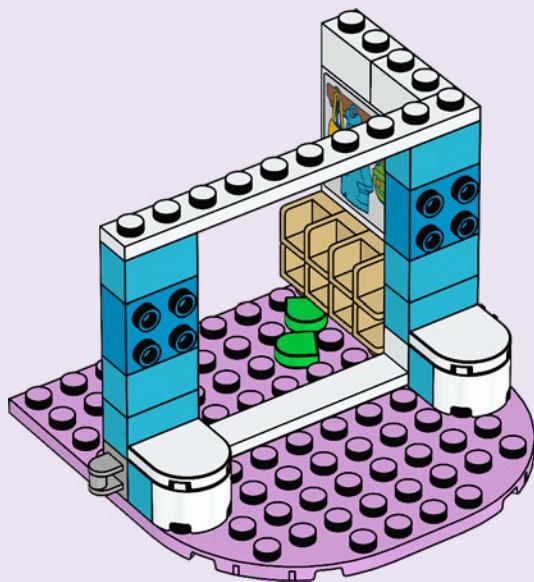

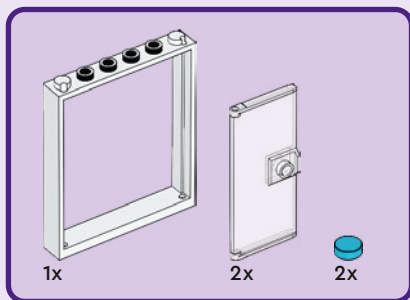

11

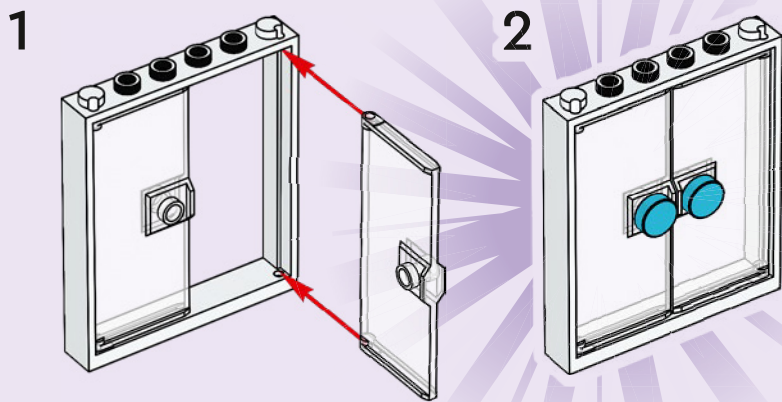

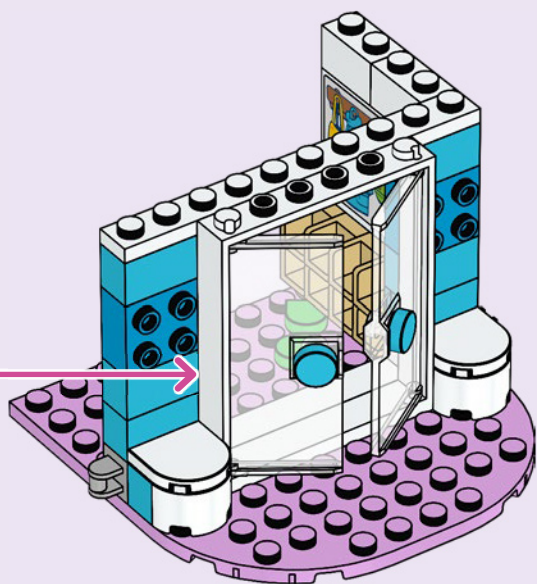

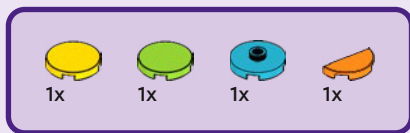

12

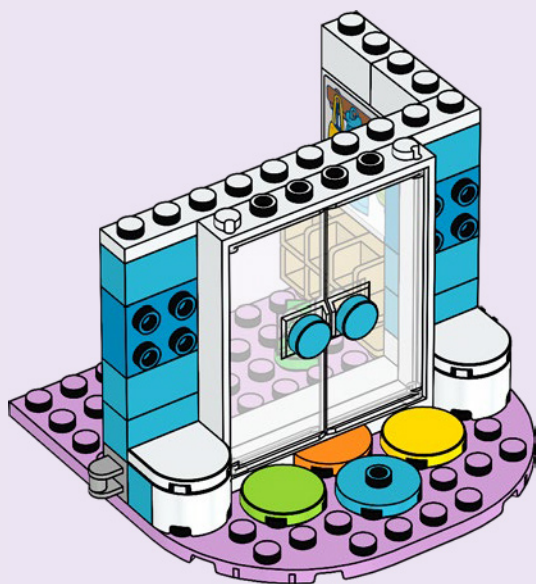

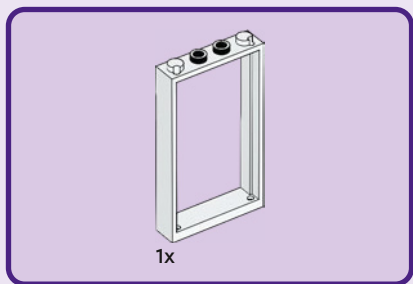

13

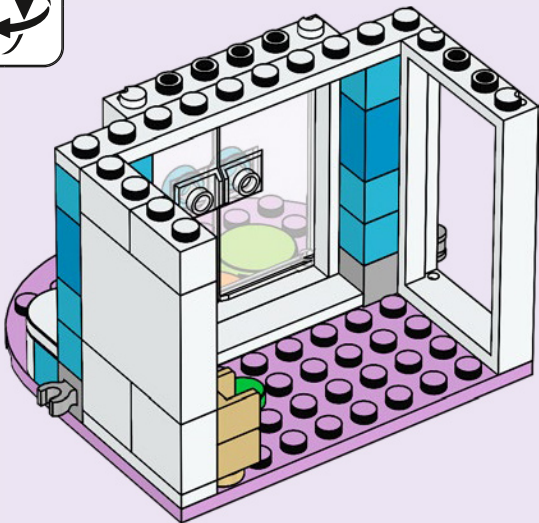



1x



1x

14

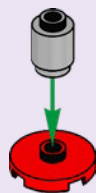

1x



1x

15

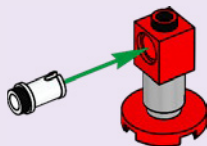

1x

16





1x



1x



1x

17

1



2



1x

18



19

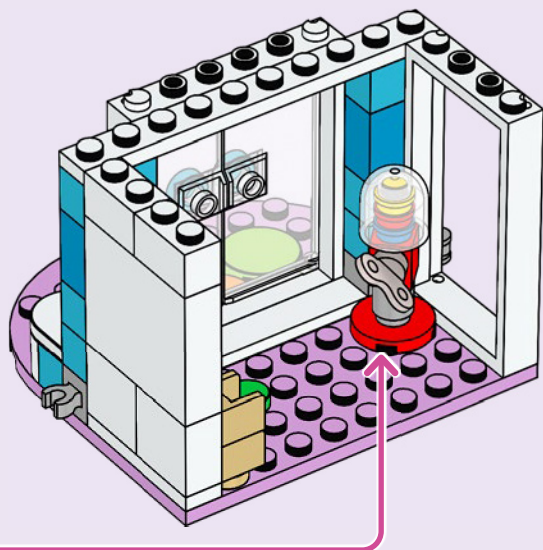

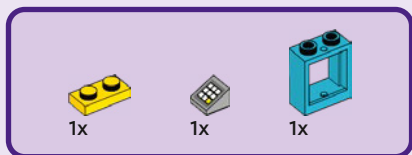

20

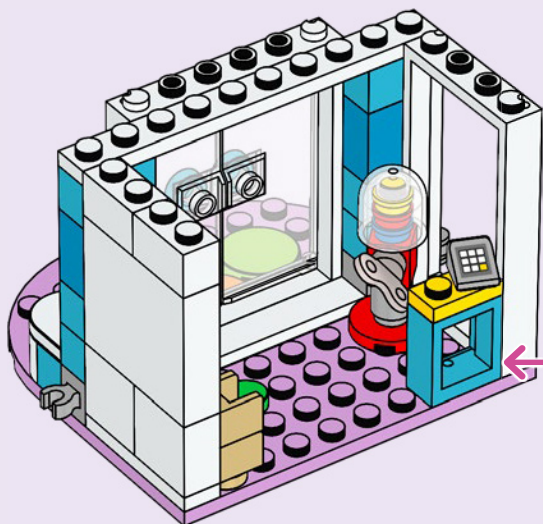
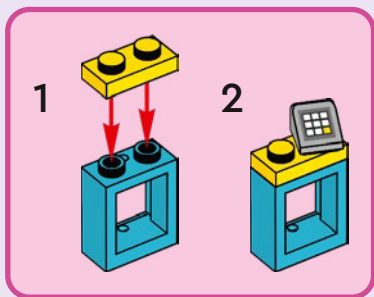



2x



2x



2x

# 21

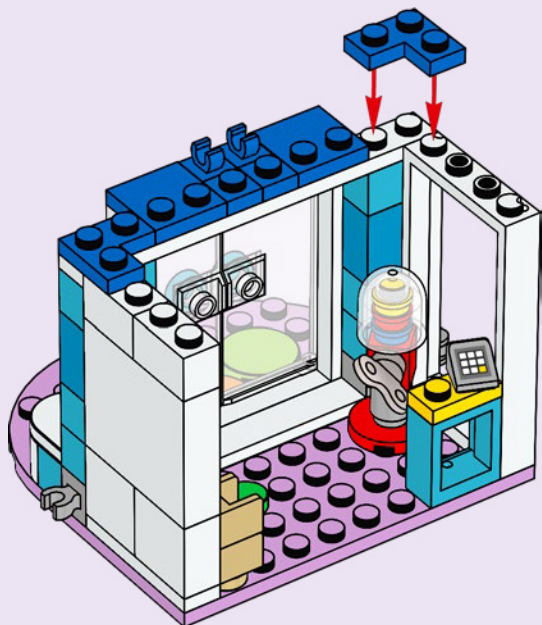

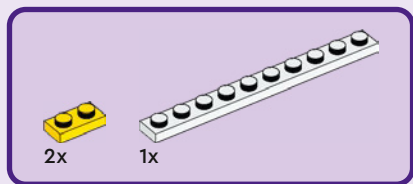

22

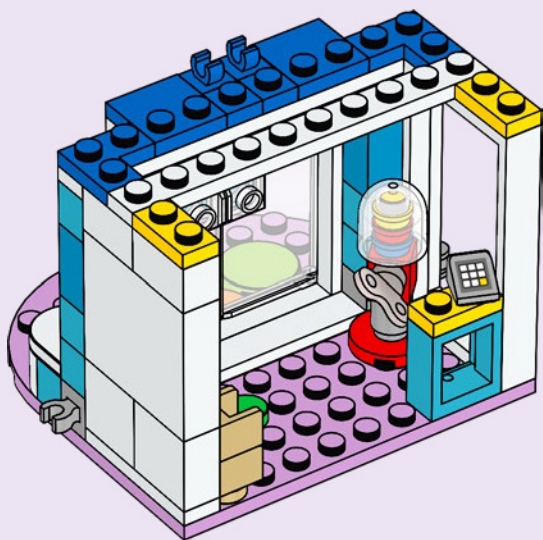



1x

23

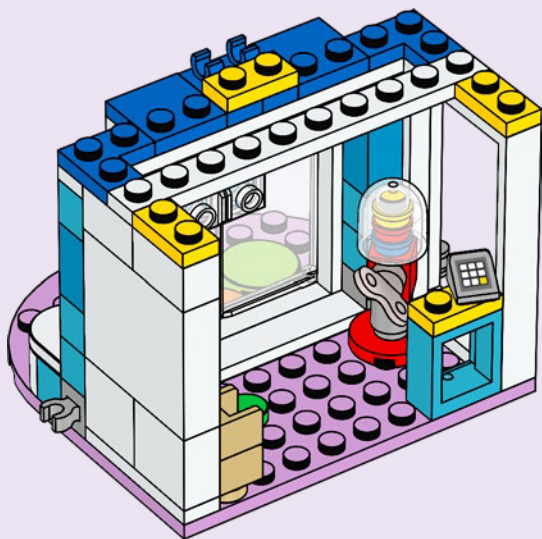

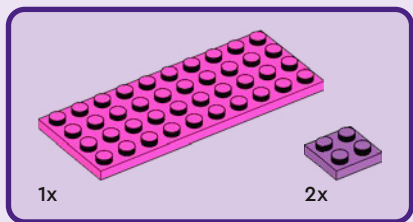
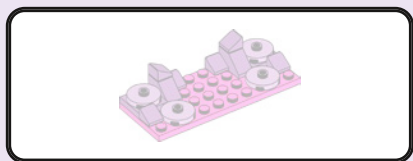

24

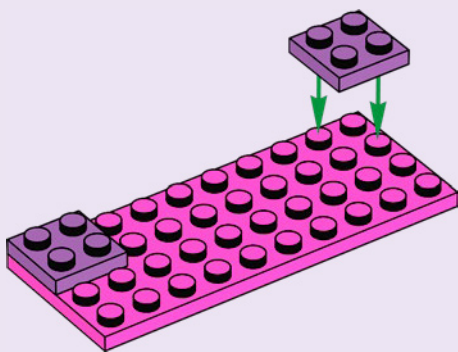



2x

25

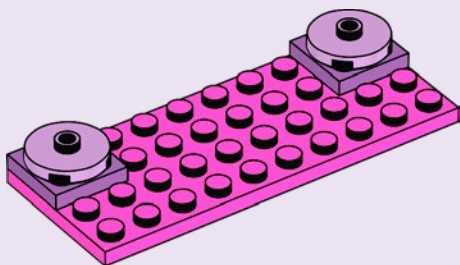

2x

26

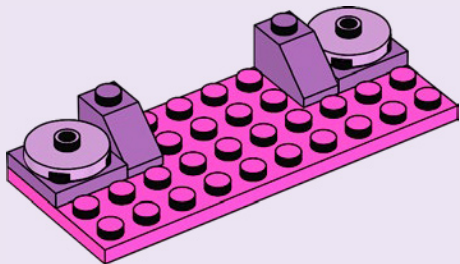



27

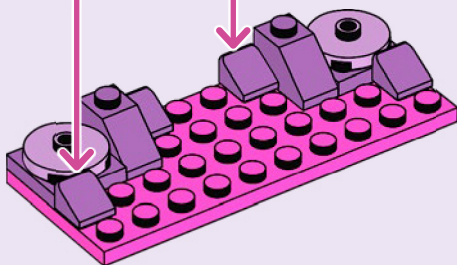

28

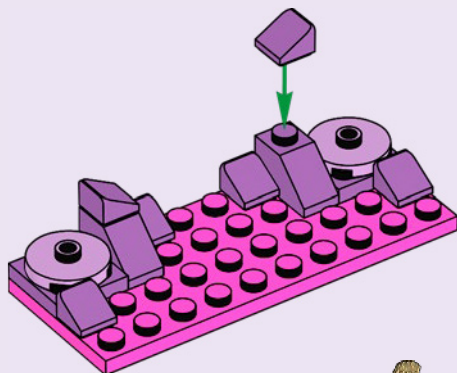



2x

29

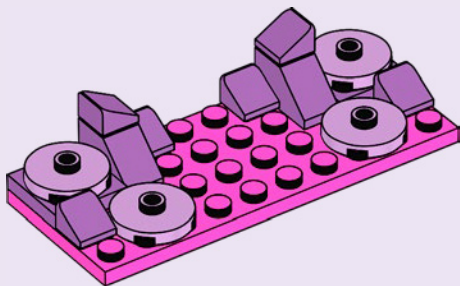

30

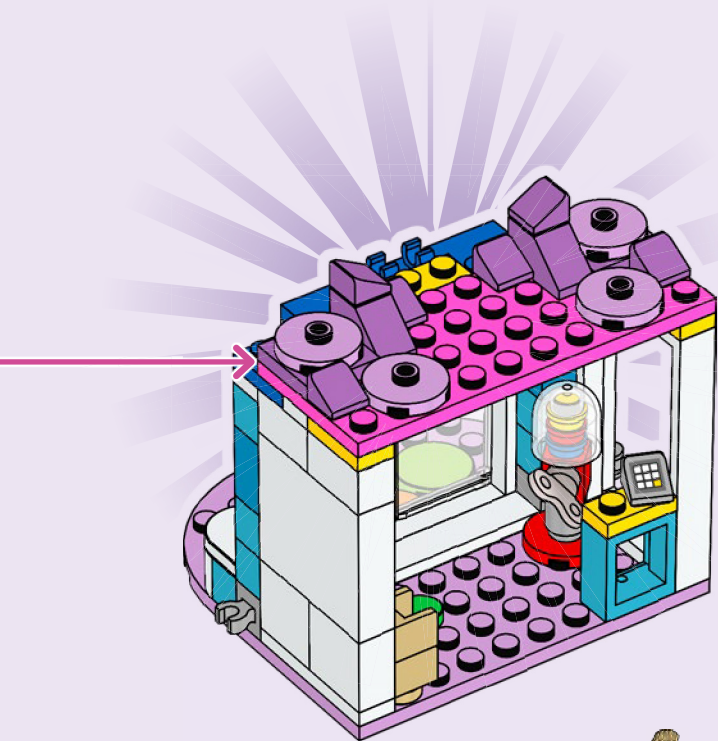

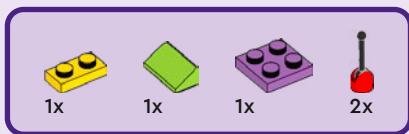

31

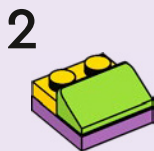
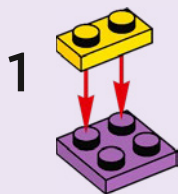



1x

32





4x

33





2x

34





1x



1x



1x

# 35

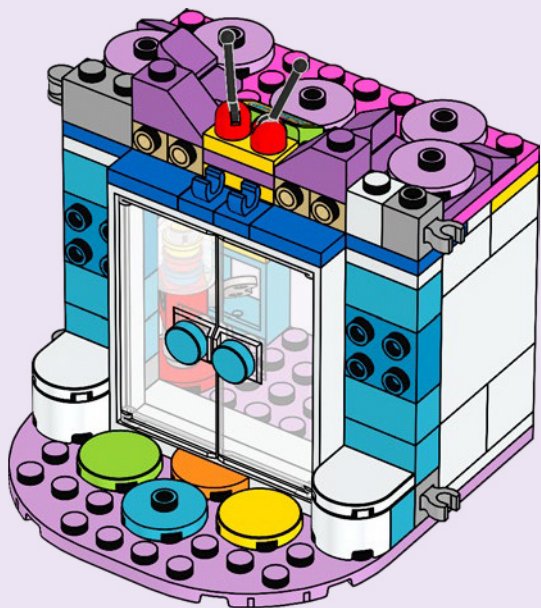

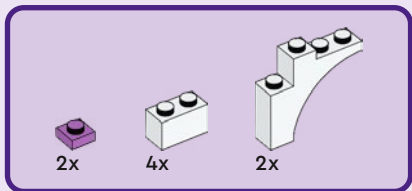
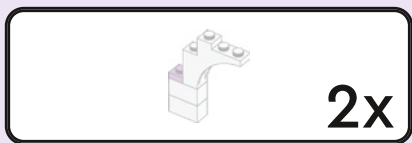

36

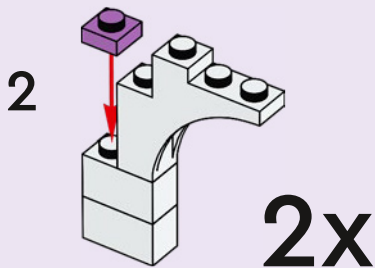
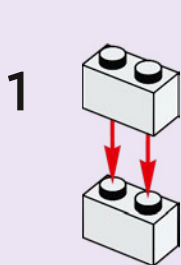

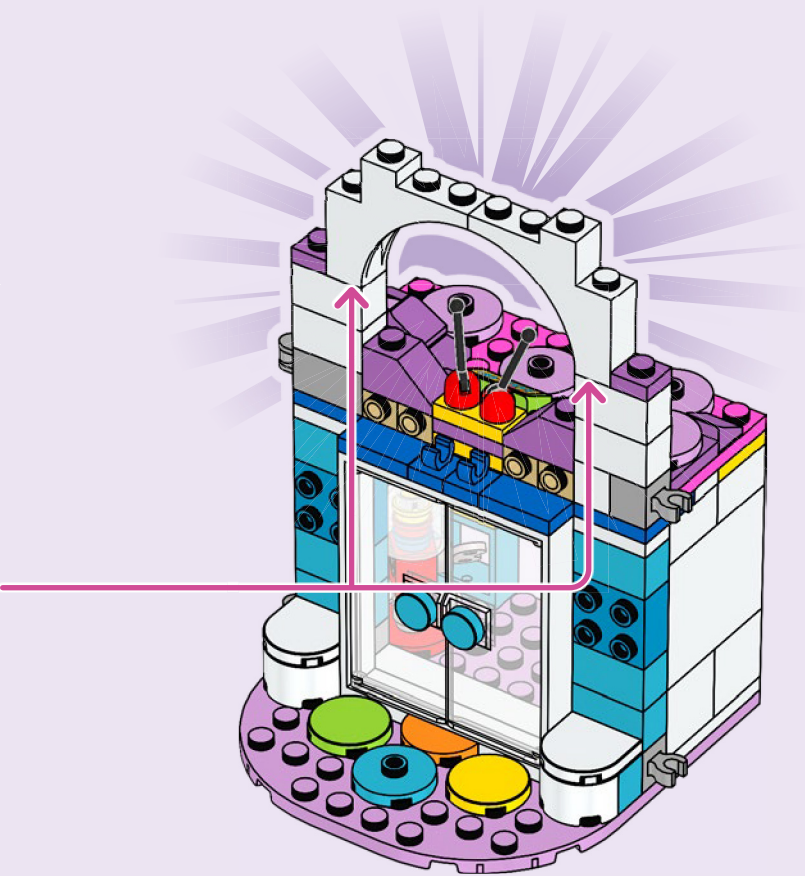

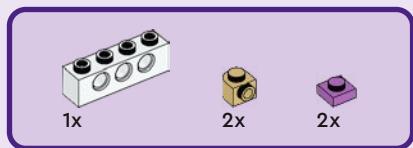

37

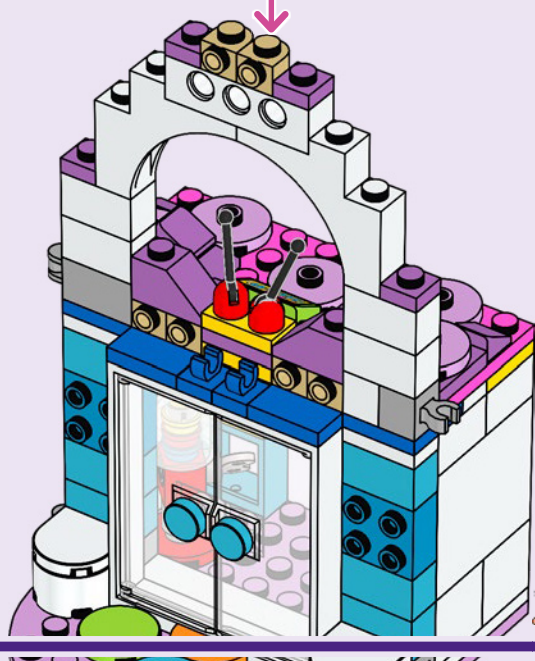
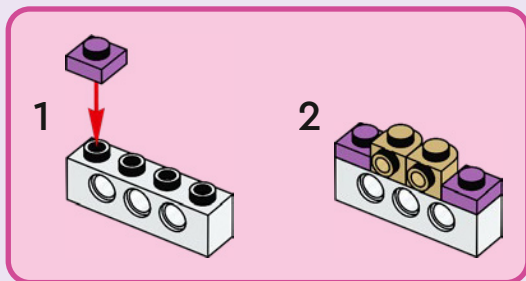

38



2x

38



2x





2x

39





2x

40





2x

41





2x

42







2x



2x



2x

# 43





1x

44



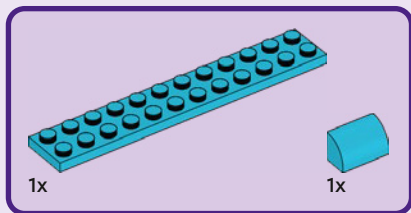
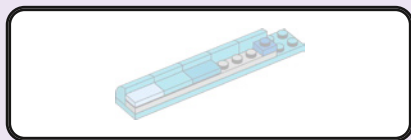

45

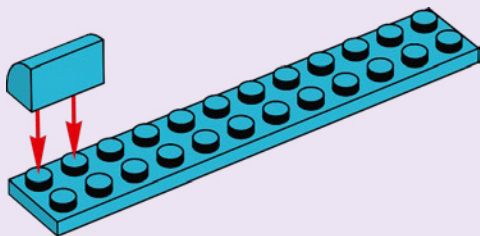

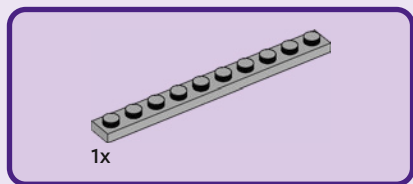

46

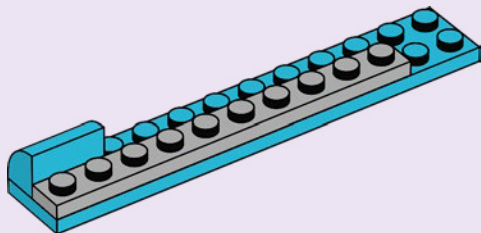

47

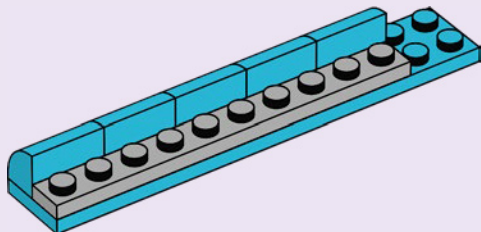

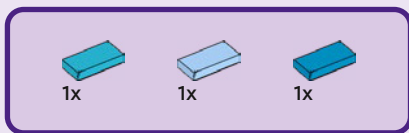

48

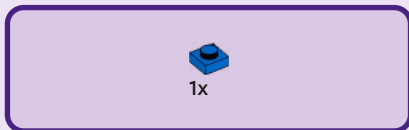
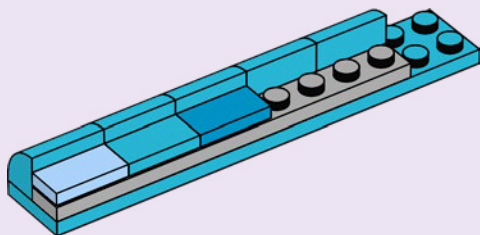

49

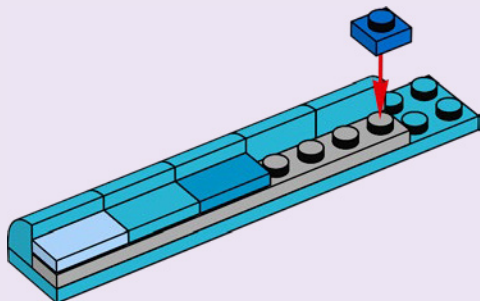

50



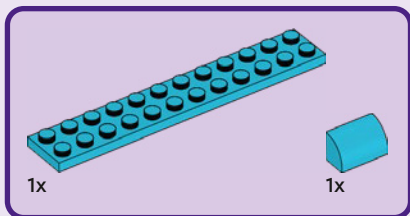
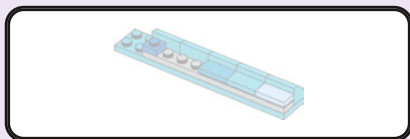

51

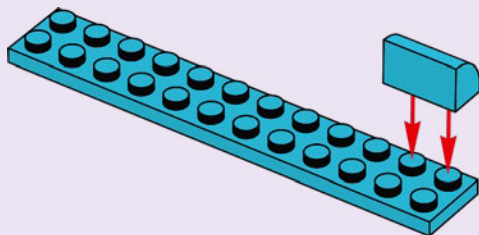

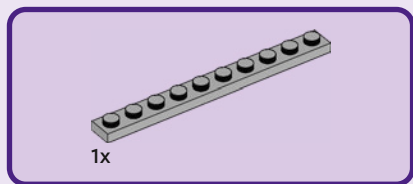

52

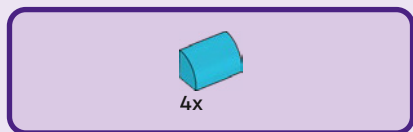
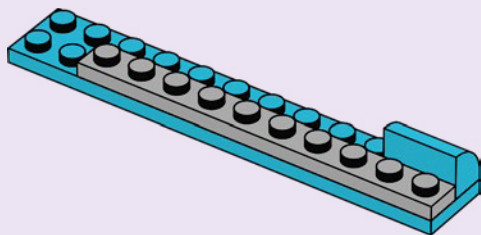

53

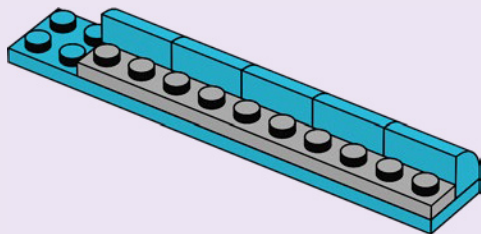



1x



1x



1x

# 54

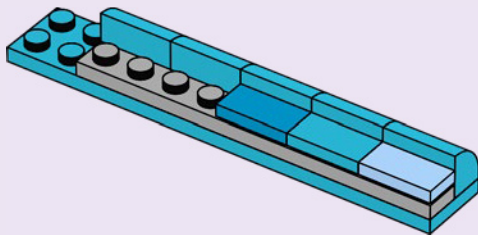

1x

# 55

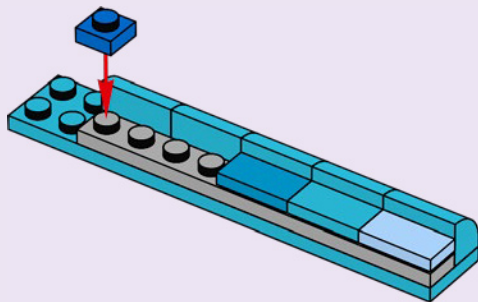





2x

57





2x

58





1x



1x

# 59



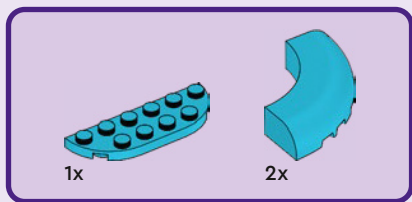

60

1

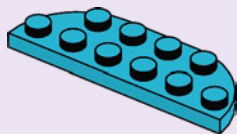

2

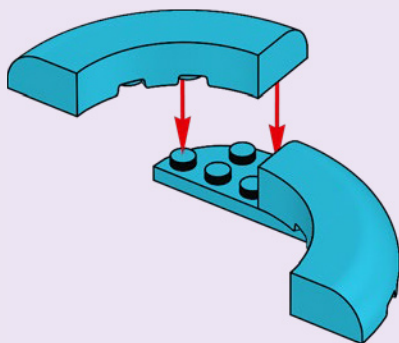





2x



2x



61

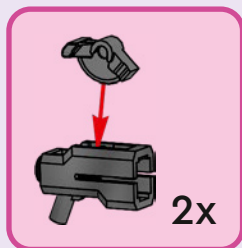
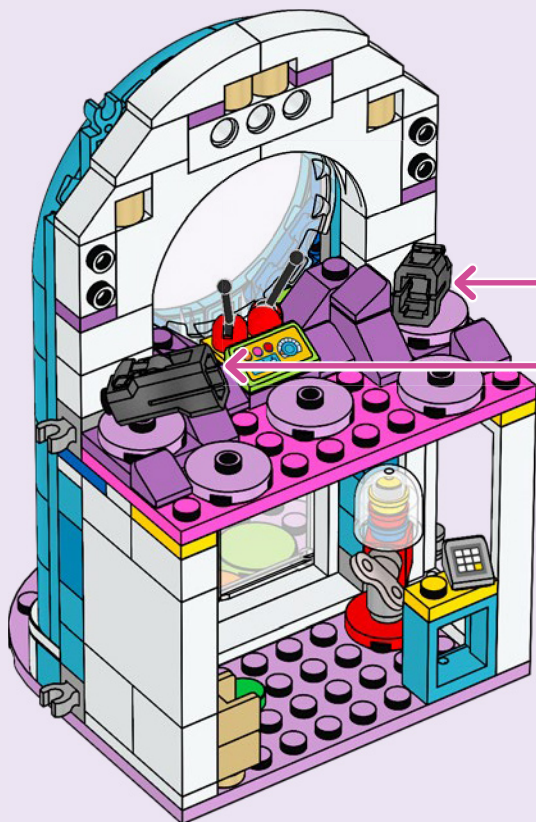



2x

62



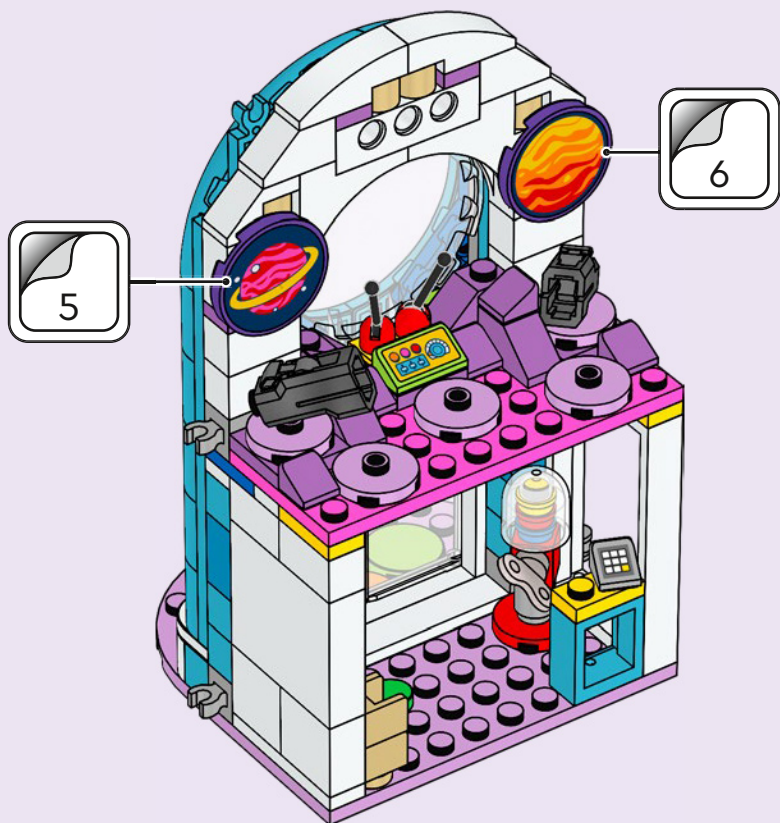

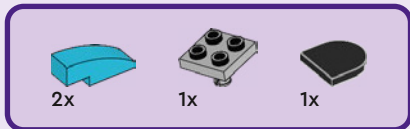

64

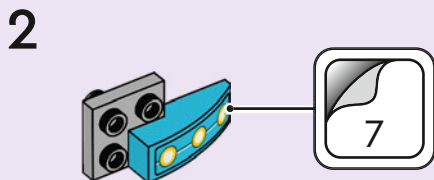
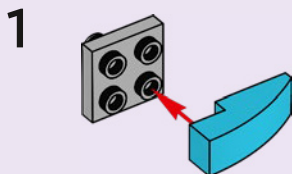

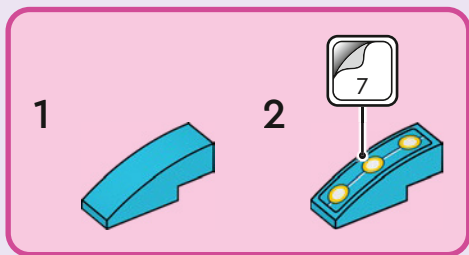

3

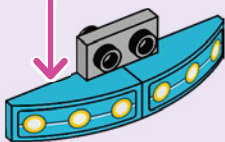

4



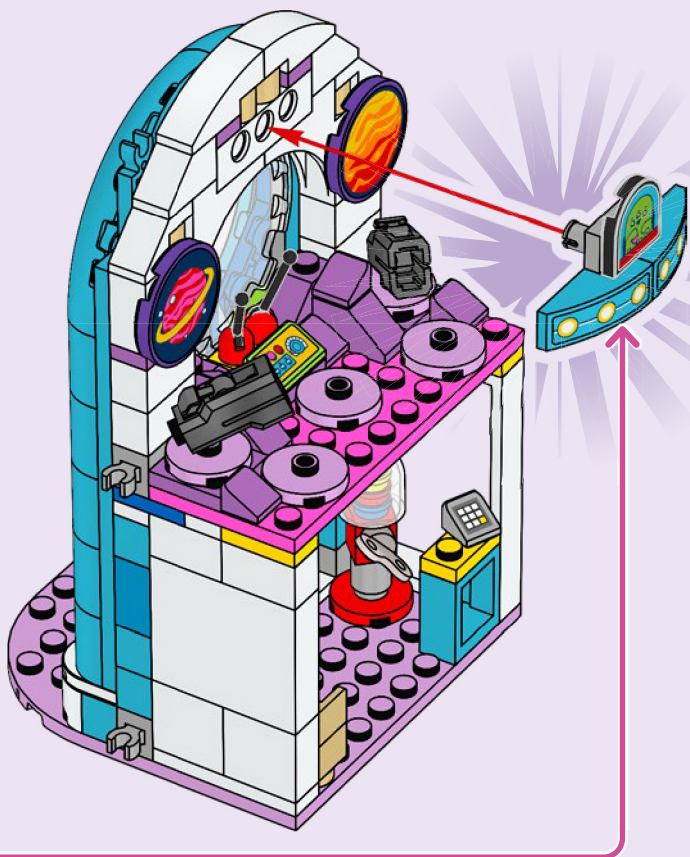

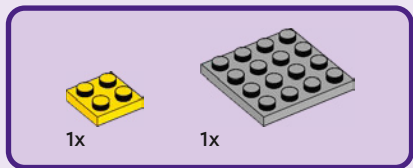

65

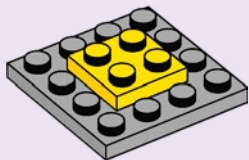



66

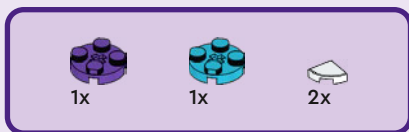
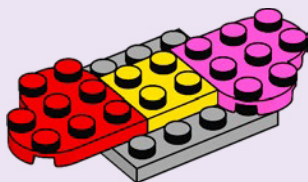

67

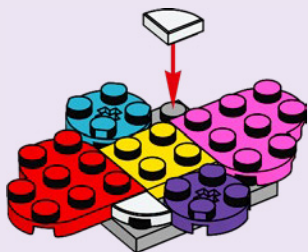



4x

68

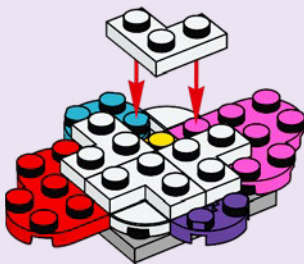



1x



1x

69

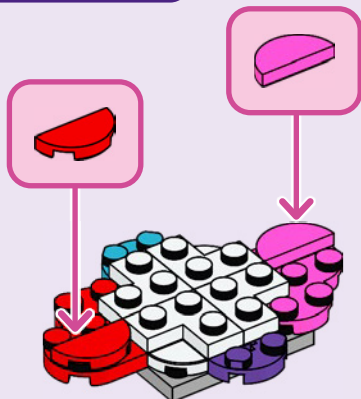

2x



2x

70

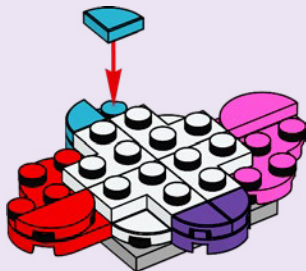



1x

71



72





73

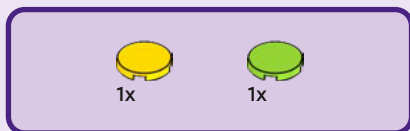

74





1x

75





1x

76

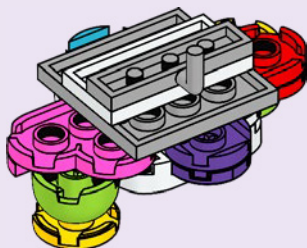

1x

77

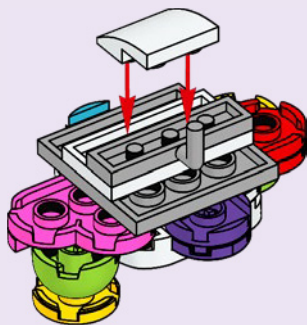

78

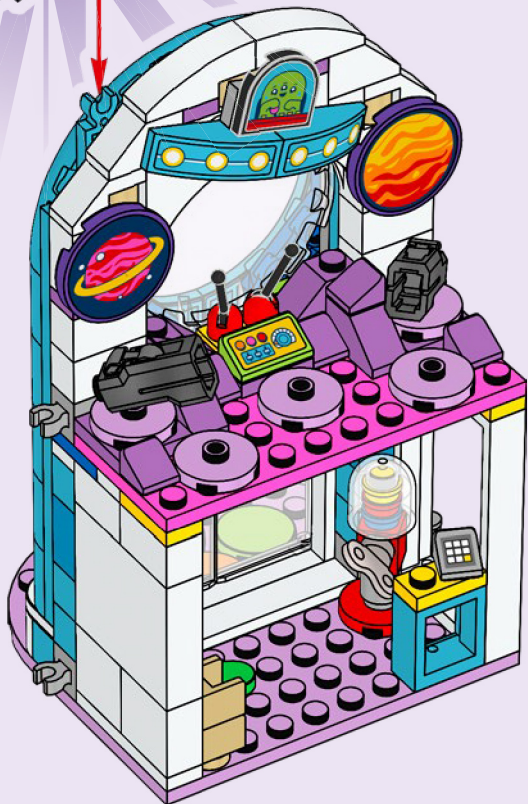



4x



79

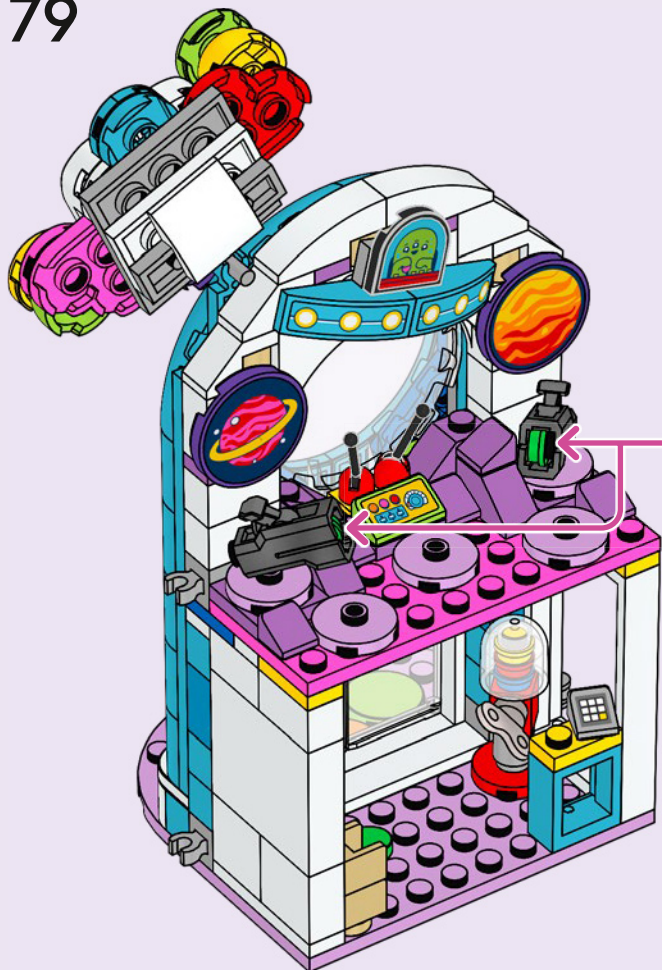

2x



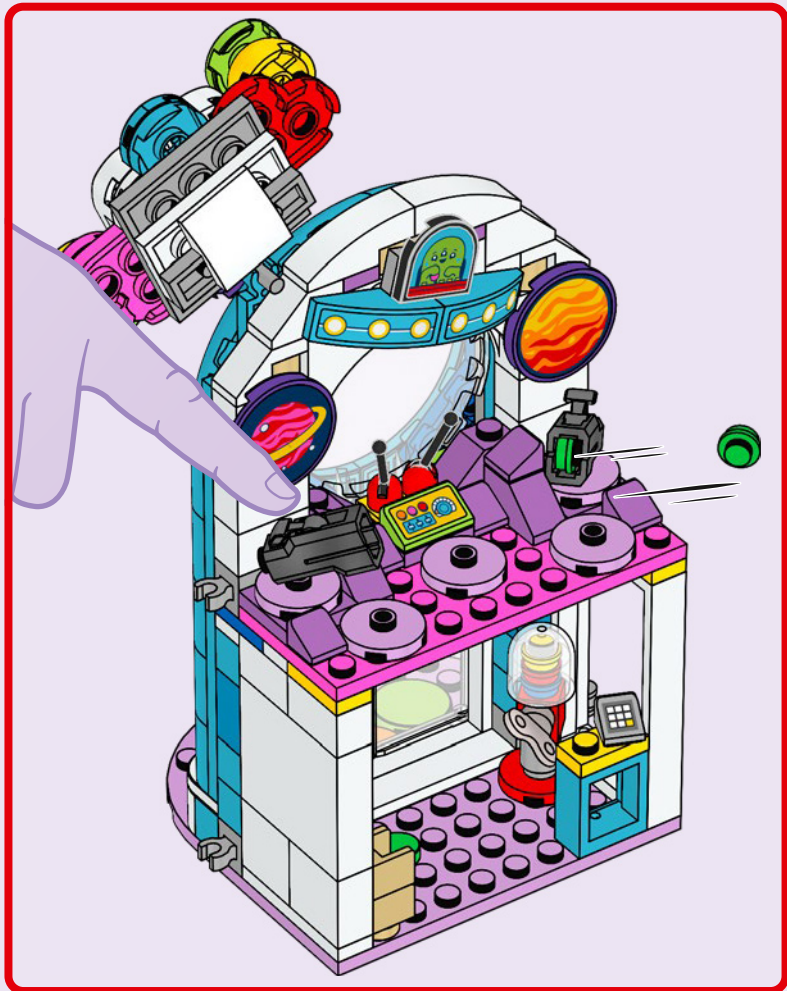



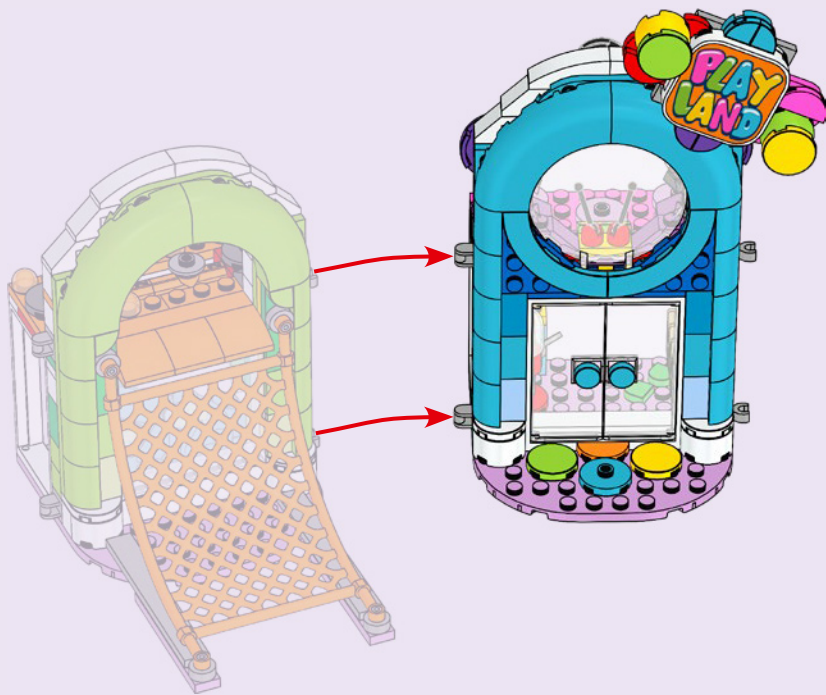

82



