



Friends

42687





LEGO.com/sustainable-packaging



FR

DONNEZ
OU
RECYCLEZ



OU



OU



ASSOCIATION

MAGASIN

DÉCHÈTERIE

Adresses sur quefairedemesdechets.fr



BUILDER



Apple and the Apple logo are trademarks of Apple Inc., registered in the U.S. and other countries and regions. App Store is a service mark of Apple Inc. Google Play and the Google Play logo are trademarks of Google LLC. Tencent and the Tencent logo are trademarks of Tencent Inc.

LEGO.com/devicecheck

EN Ask parents' permission before going online | **DE** Eltern um Erlaubnis bitten, bevor du online gehst | **FR** Demande l'autorisation d'un parent avant d'aller en ligne | **IT** Chiedi il permesso ai tuoi genitori prima di andare online | **ES** Pídeles permiso a tus papás antes de conectarte a Internet | **PT** Peça autorização aos pais antes de acederes online | **ZH** 上网前应先征得父母的同意 | **PL** Poproś rodziców o zgodę, zanim wejdziesz do Internetu | **CS** Než půjdeš na internet, požádej rodiče o svolení | **SK** Skôr než pôjdeš na internet, vypýtaj si povolenie od rodičov | **HU** Kérj szülői engedélyt, mielőtt online csatlakoznál! | **UA** Запитуйте дозволу батьків, перш ніж користуватися інтернетом | **RO** Cere permisiunea părinților înainte de a te conecta online | **BG** Поискайте разрешение от родител, преди да влезете онлайн | **LV** Pirms došanās tiešsaistē palūdz atļauju vecākiem | **ET** Enne Interneti kasutamist küsi vanematelt luba | **LT** Prieš prisijungdami prie interneto, atsiklauskite tėvų

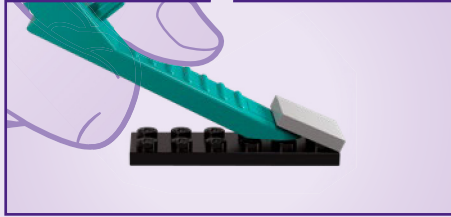
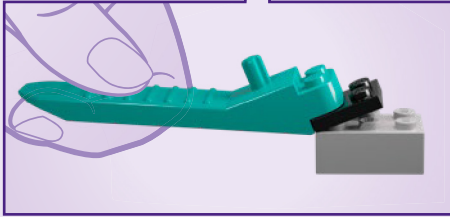
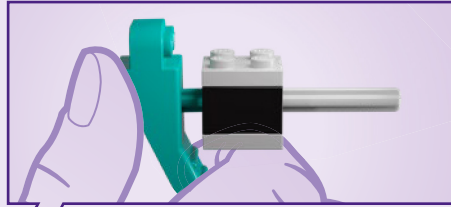
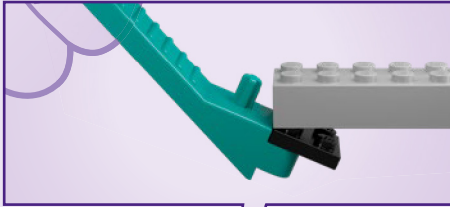

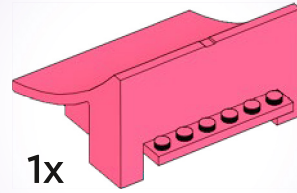
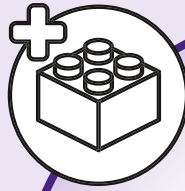

Liann

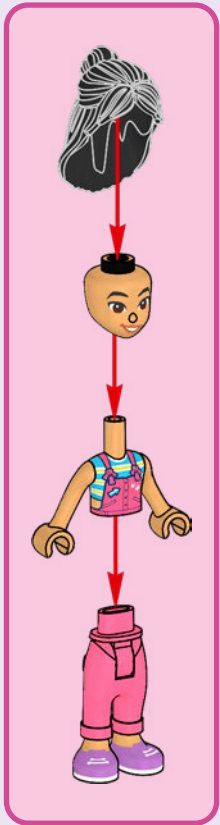

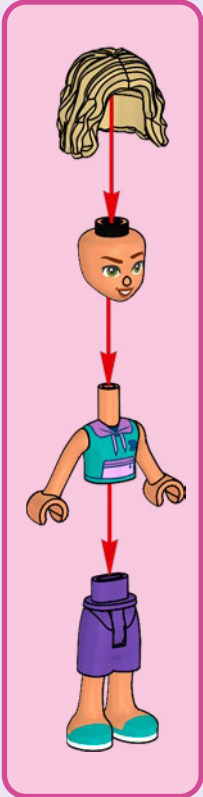

Nova





1

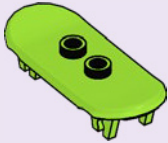

2

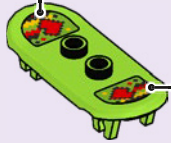

3



1

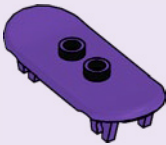

2

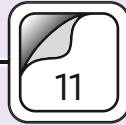
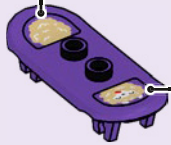

3

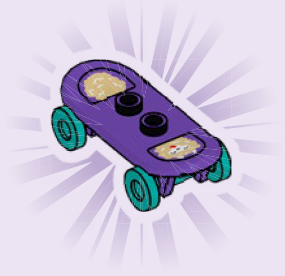

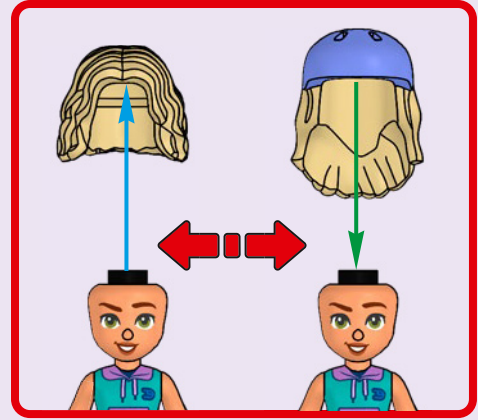
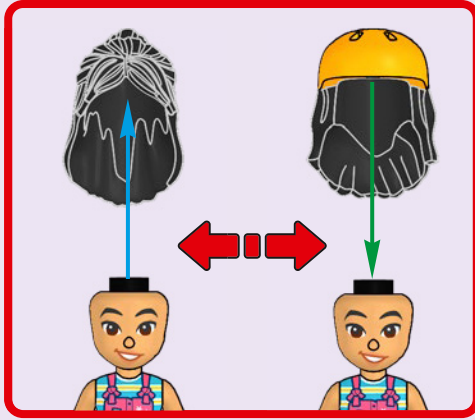

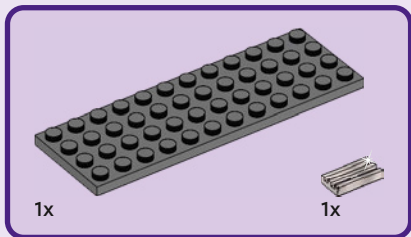
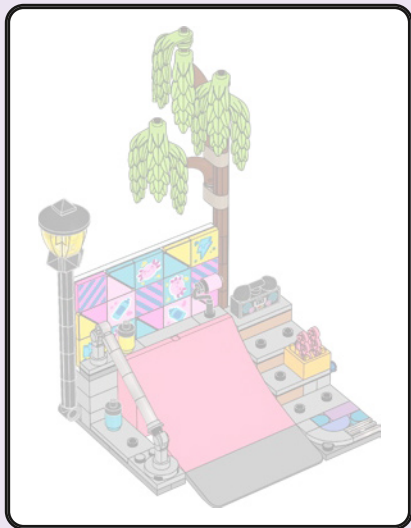

1

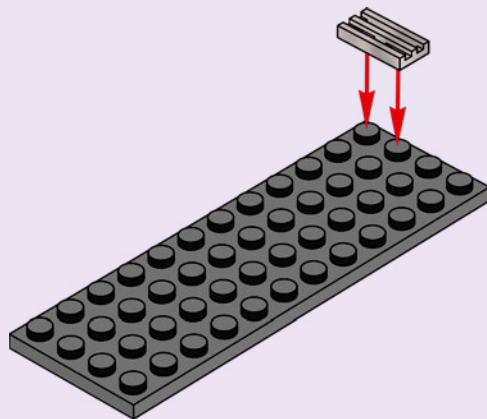

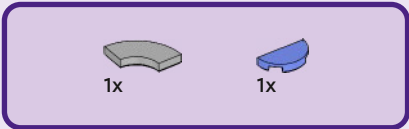

2

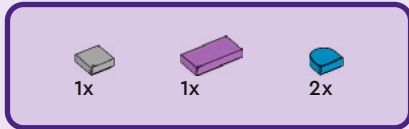
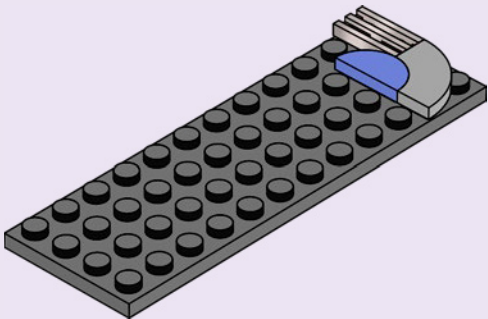

3

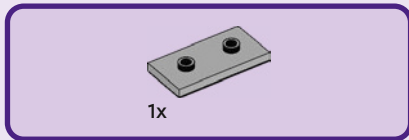
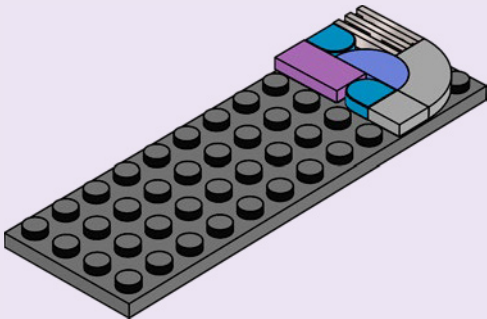

4

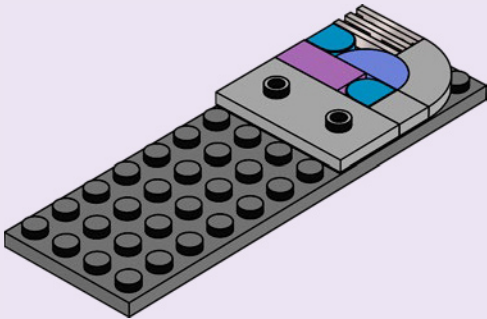

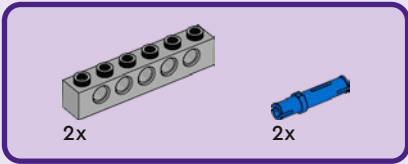

5

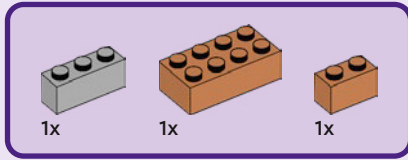
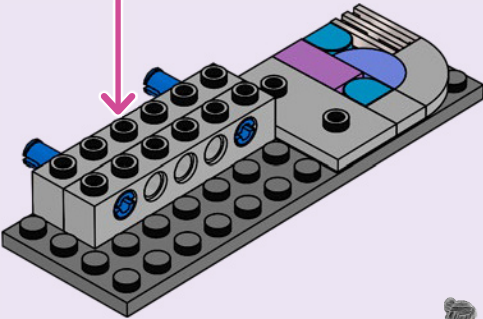
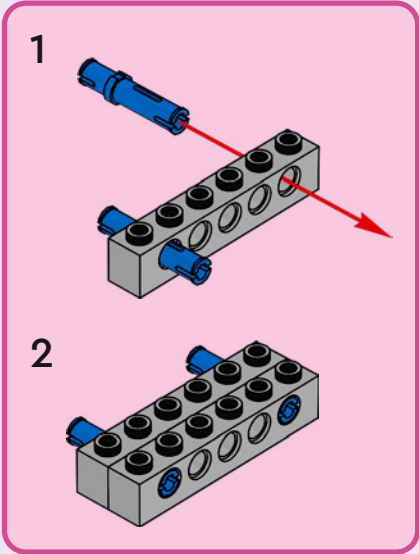

6

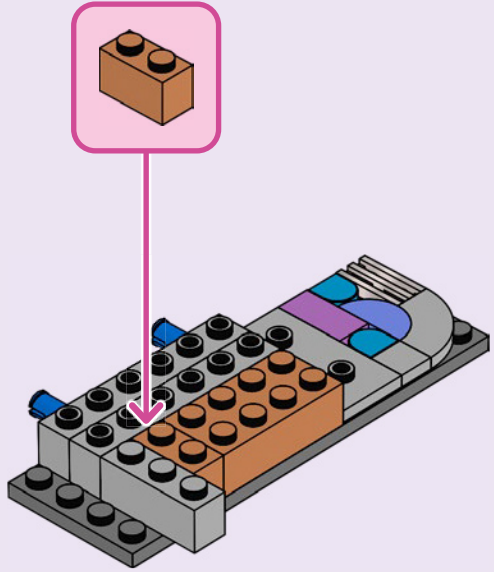

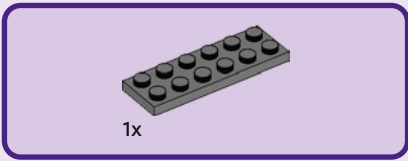

7

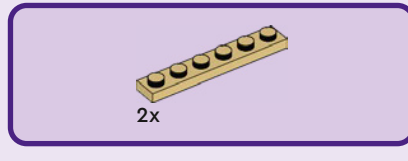
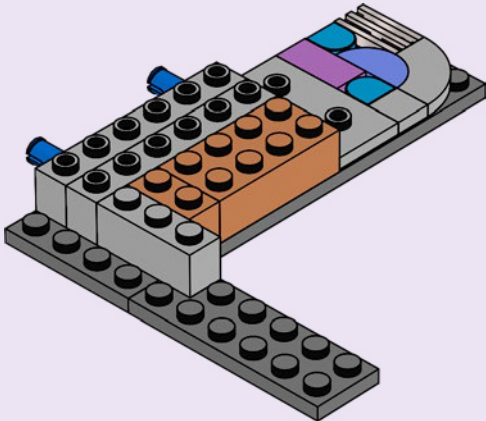

8

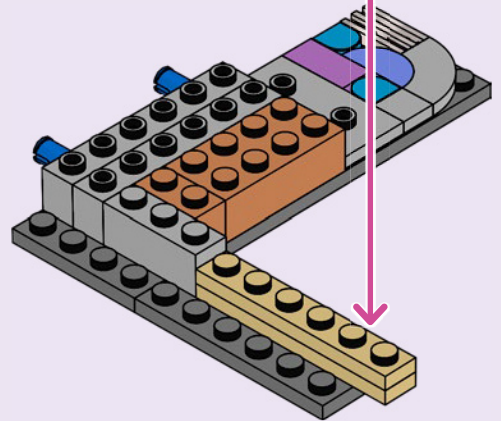
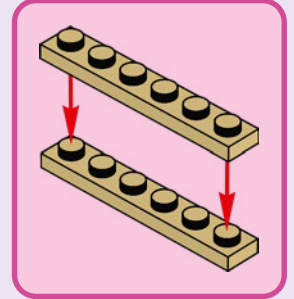



1x

9

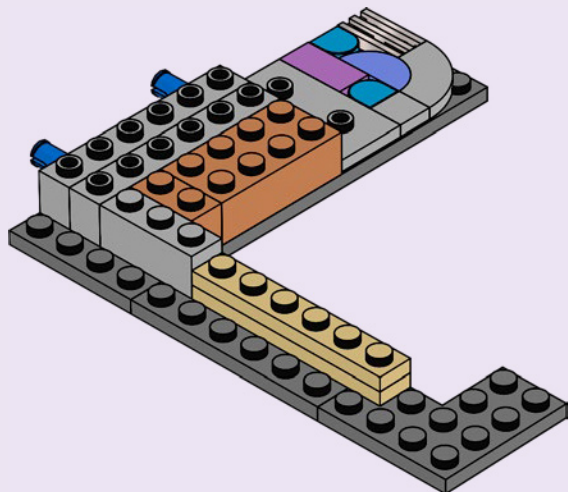

1x

10

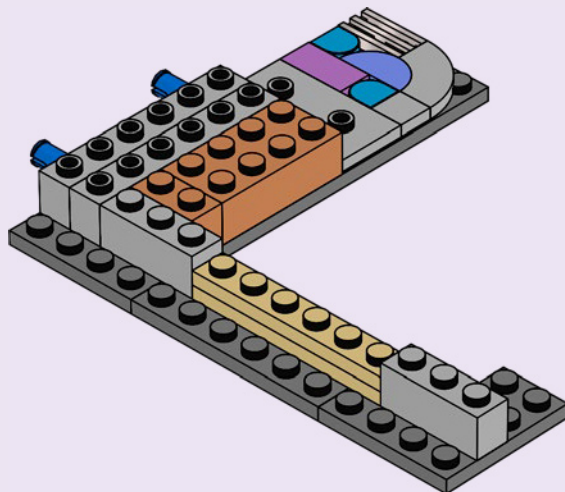



1x



1x

11

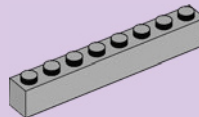
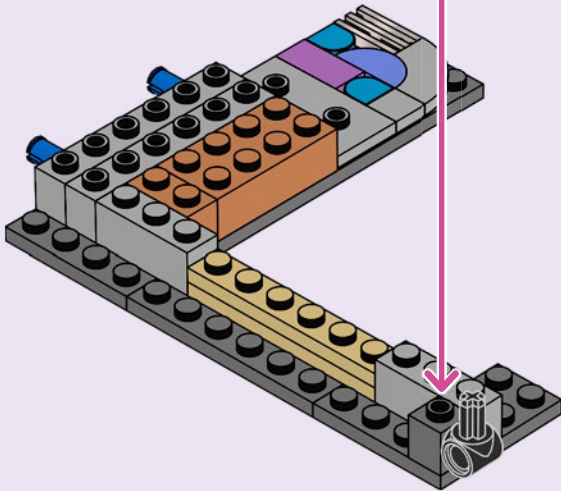
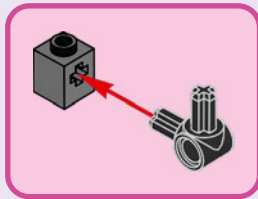

1x



1x



1x

12

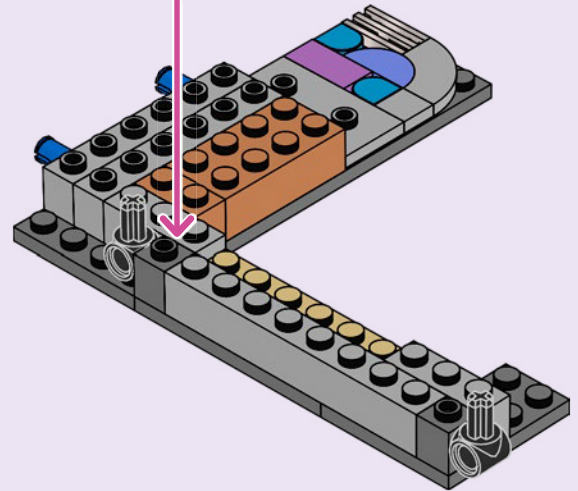
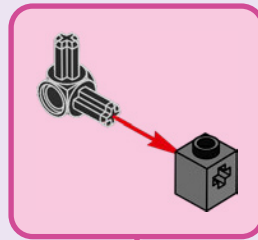

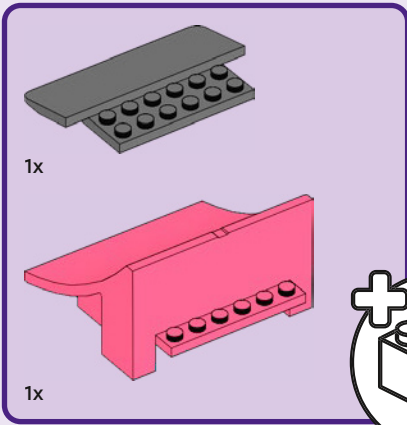

13

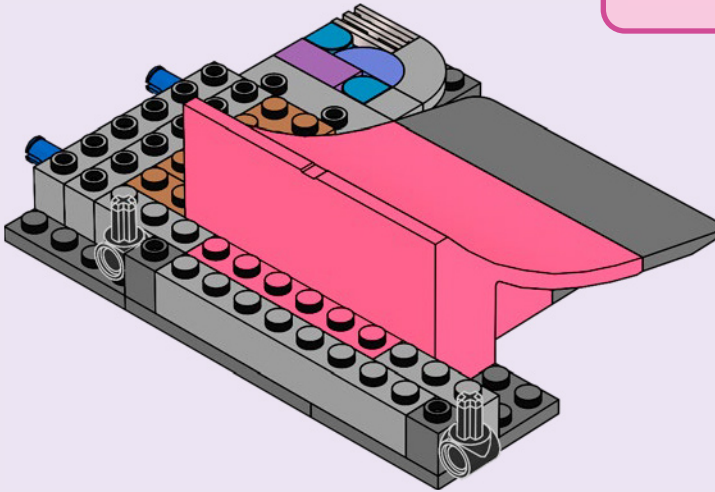
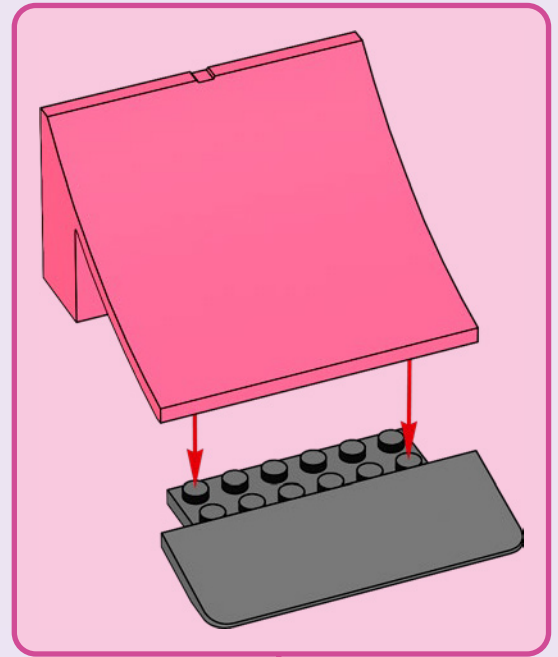
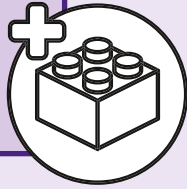

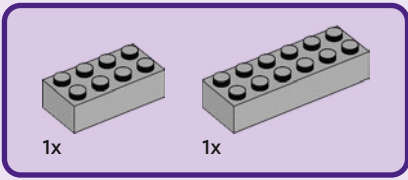

14

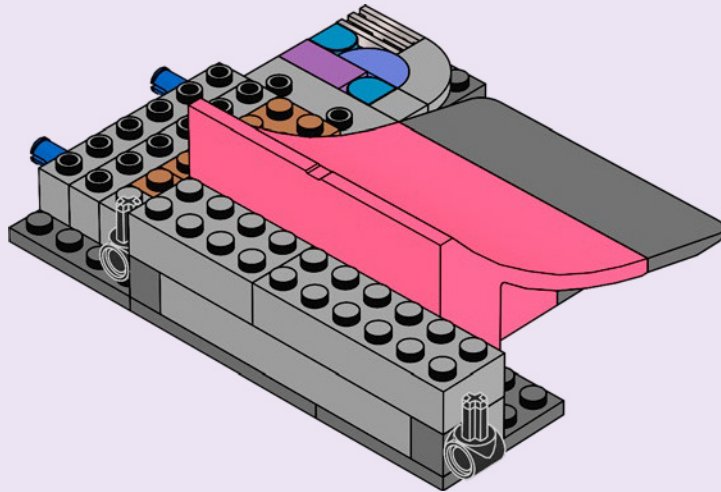

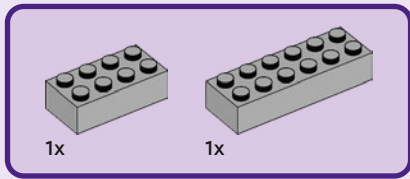

15

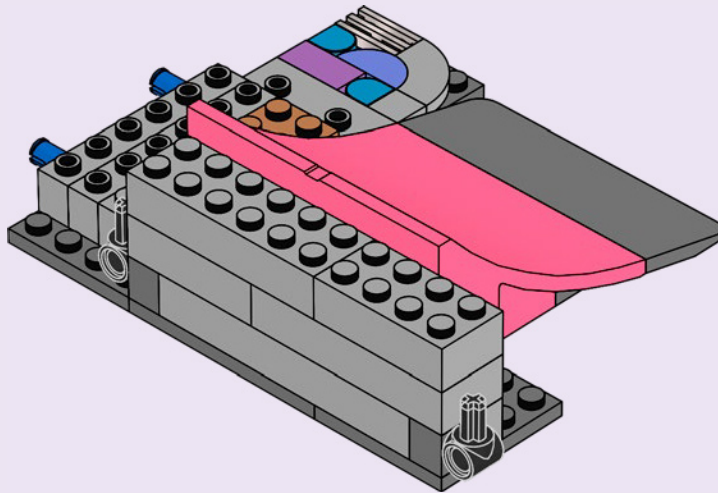

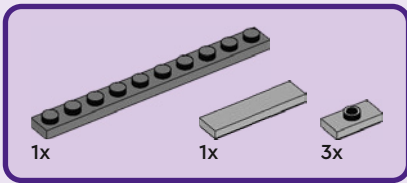

16

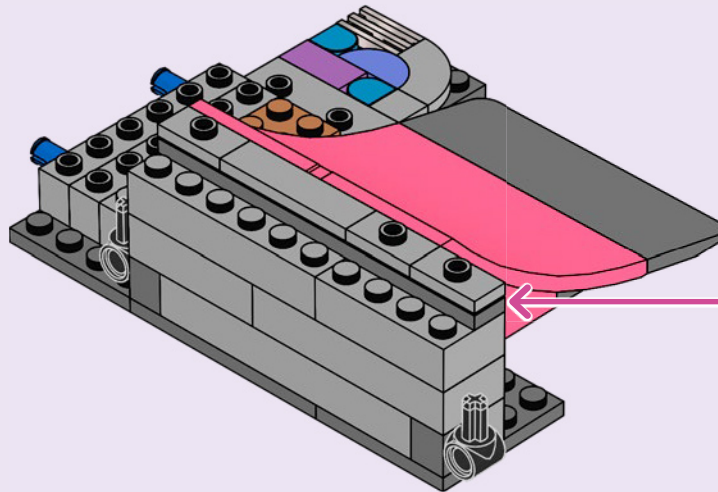
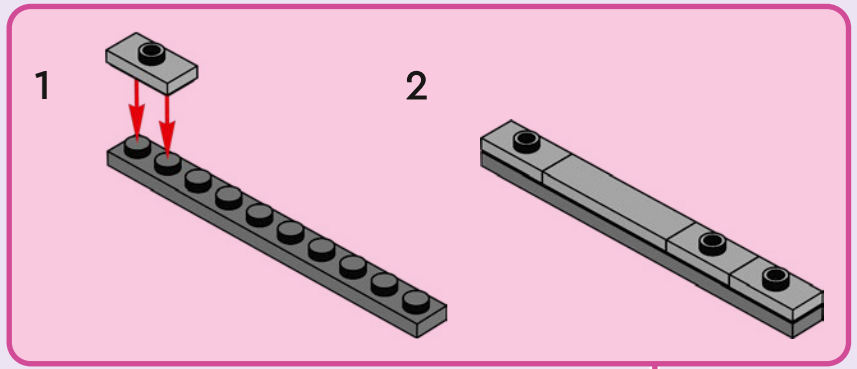

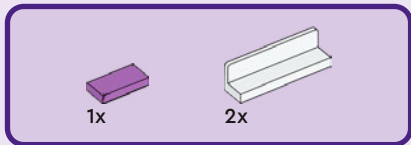

17

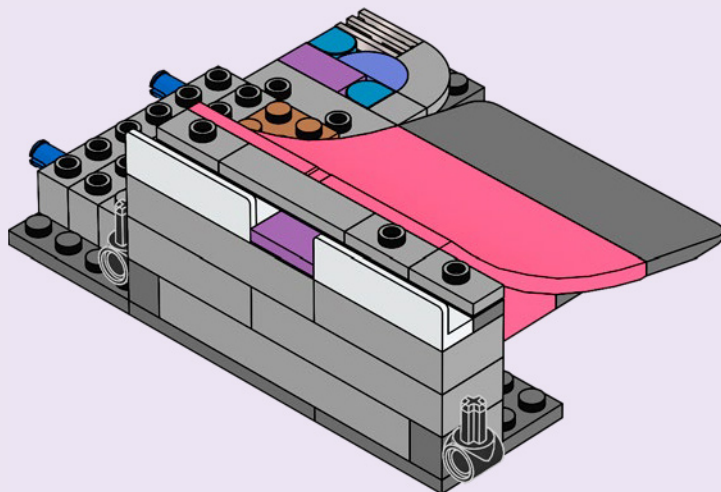

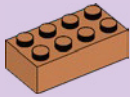

2x

18

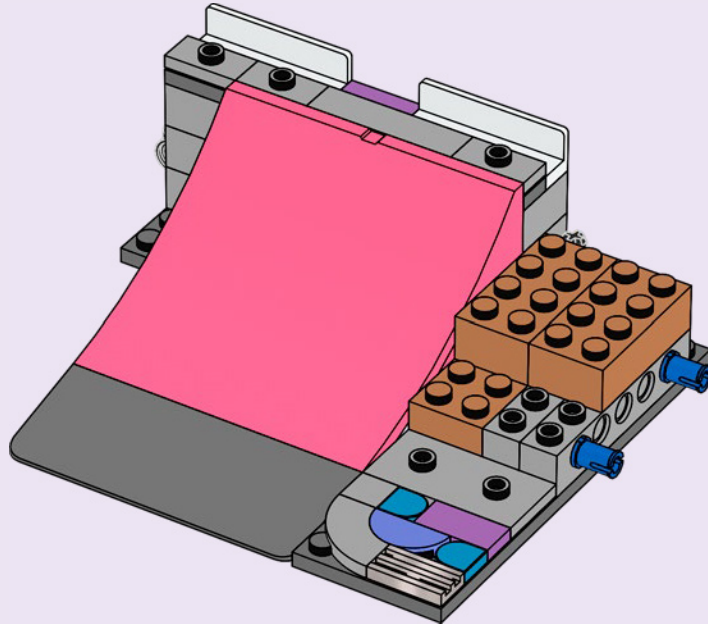



1x

19

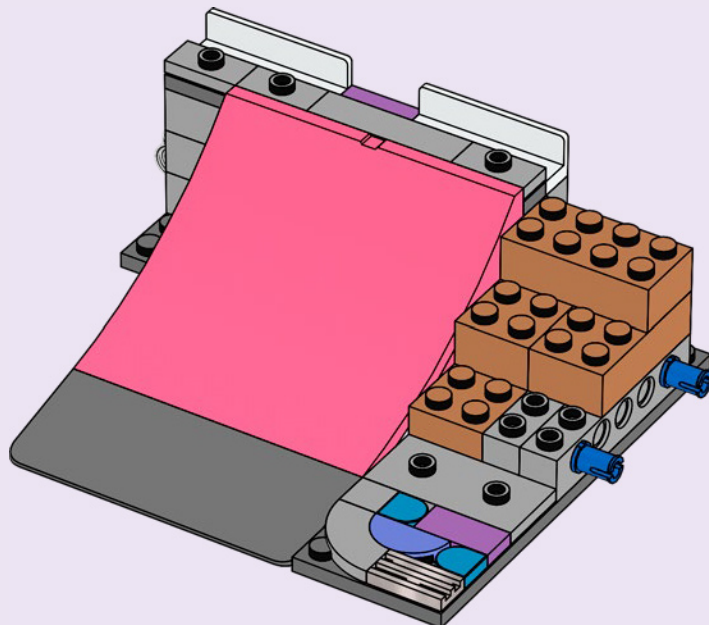

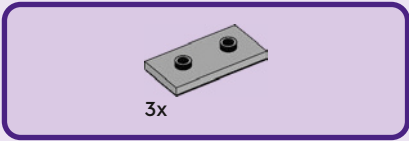

20

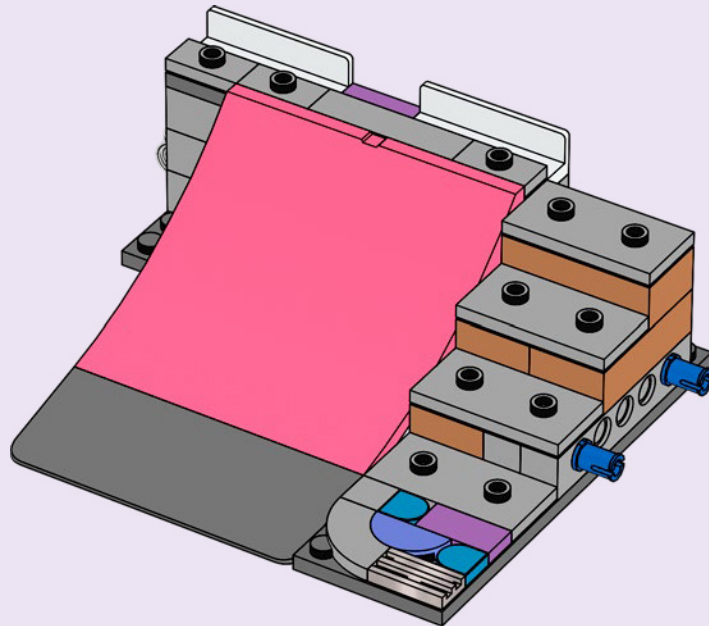

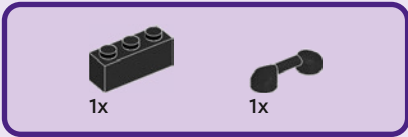

21

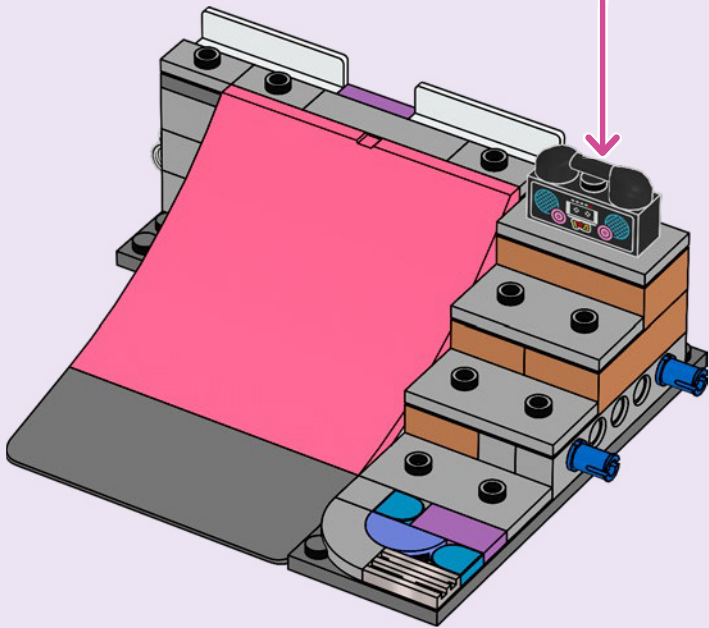
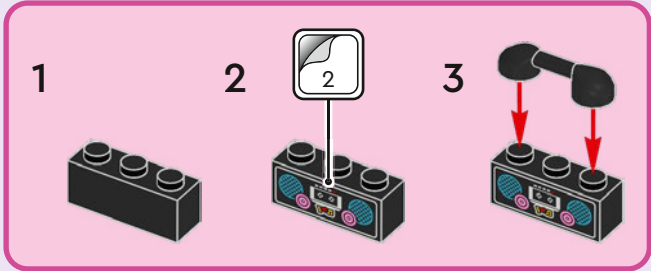

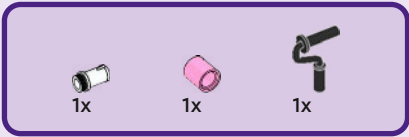

22

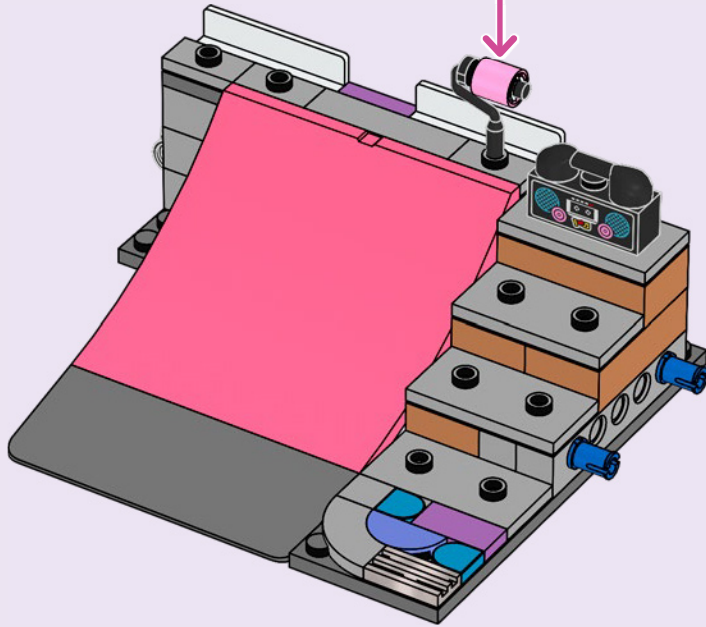
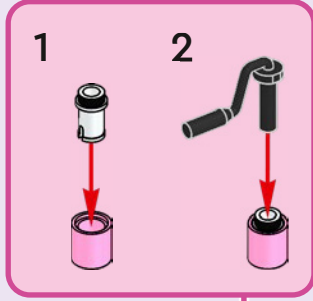

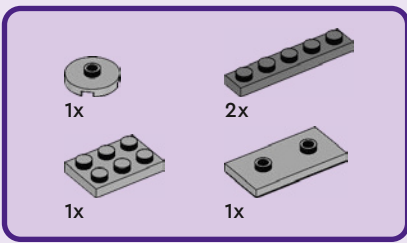

23

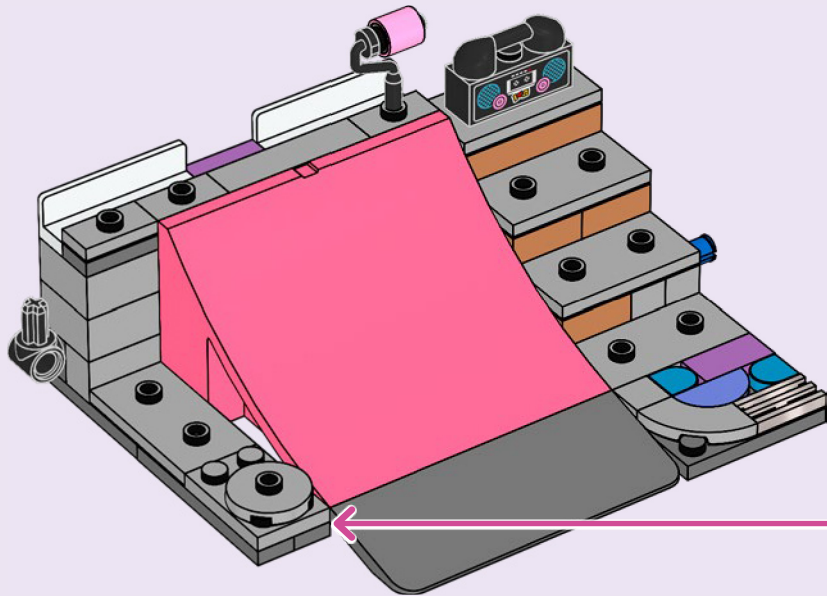
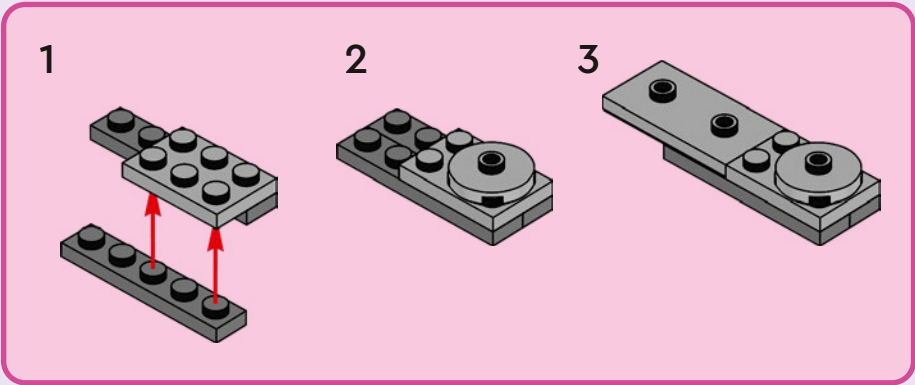



24

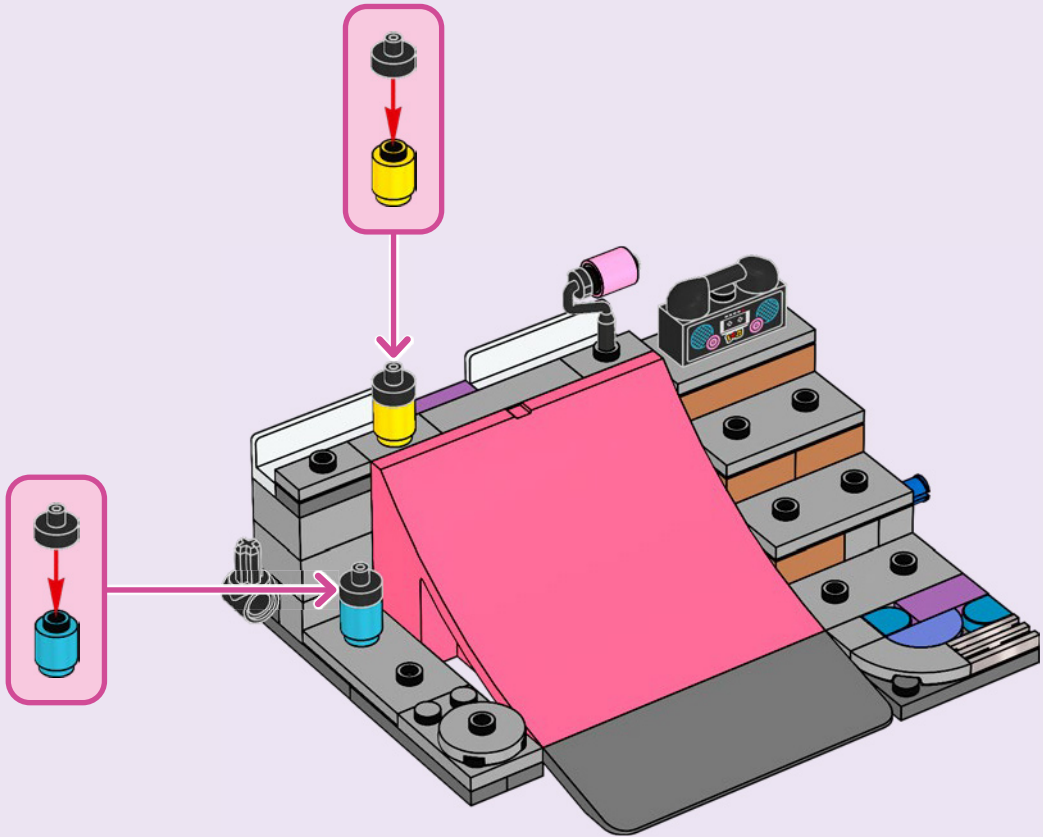



1x



1x

25

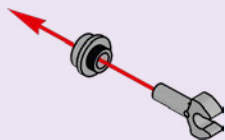

3x

26

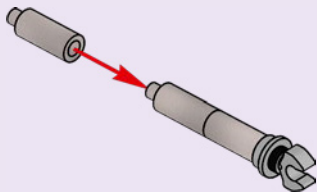

1x

27

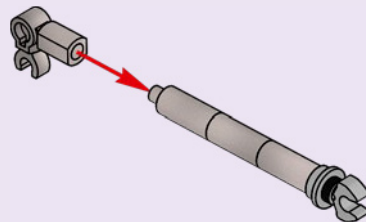

2x



2x

28



2x

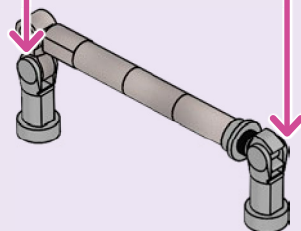

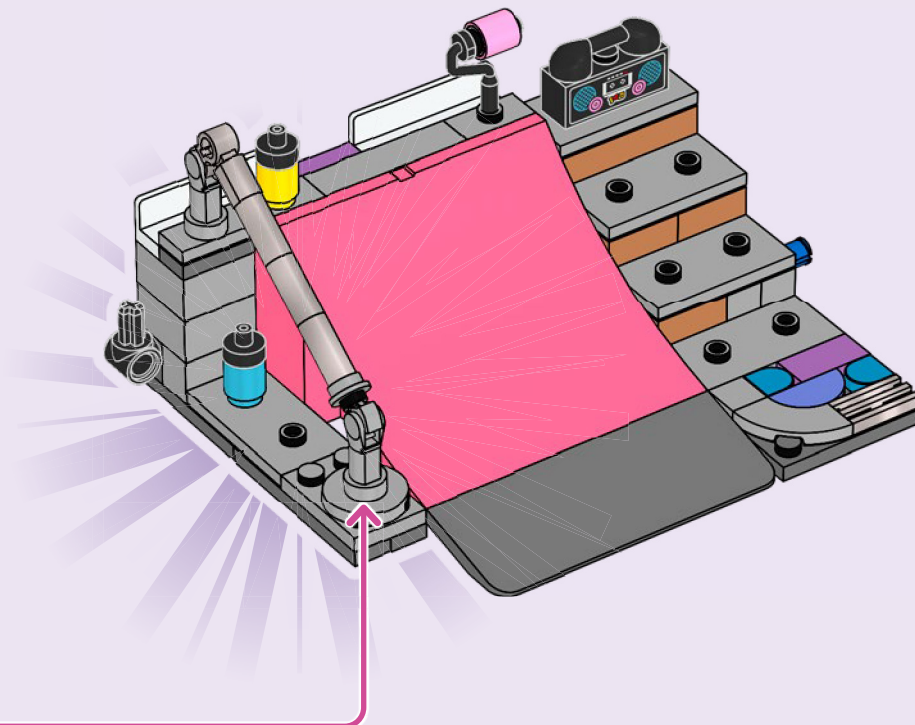



30

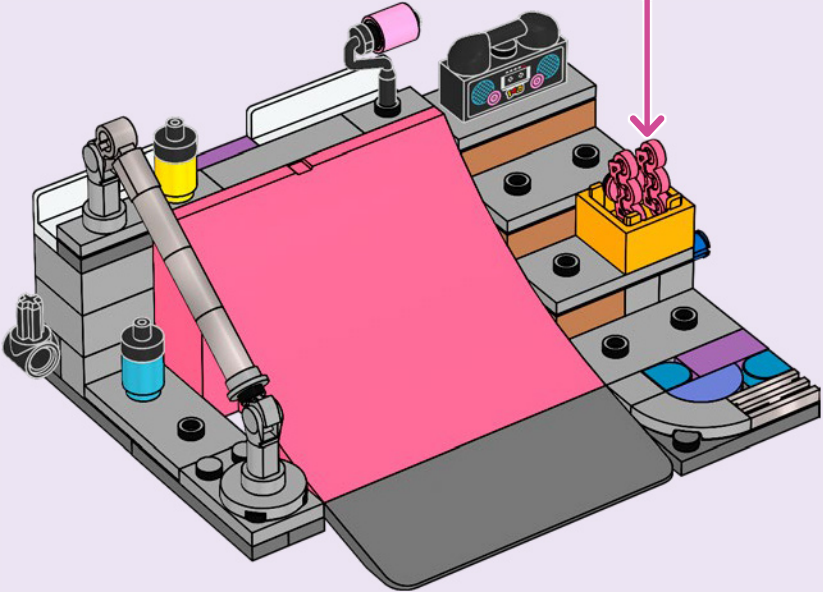
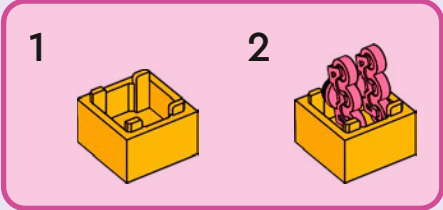



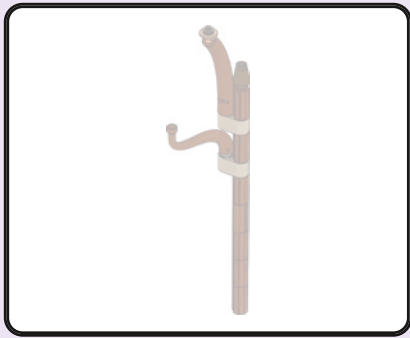

31

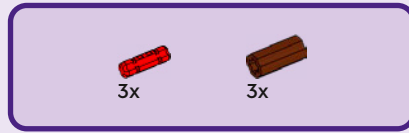

32

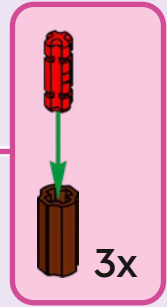

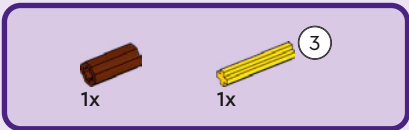

33

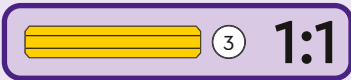

34

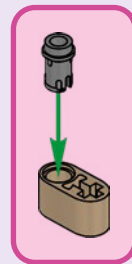

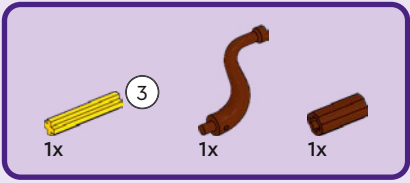

35

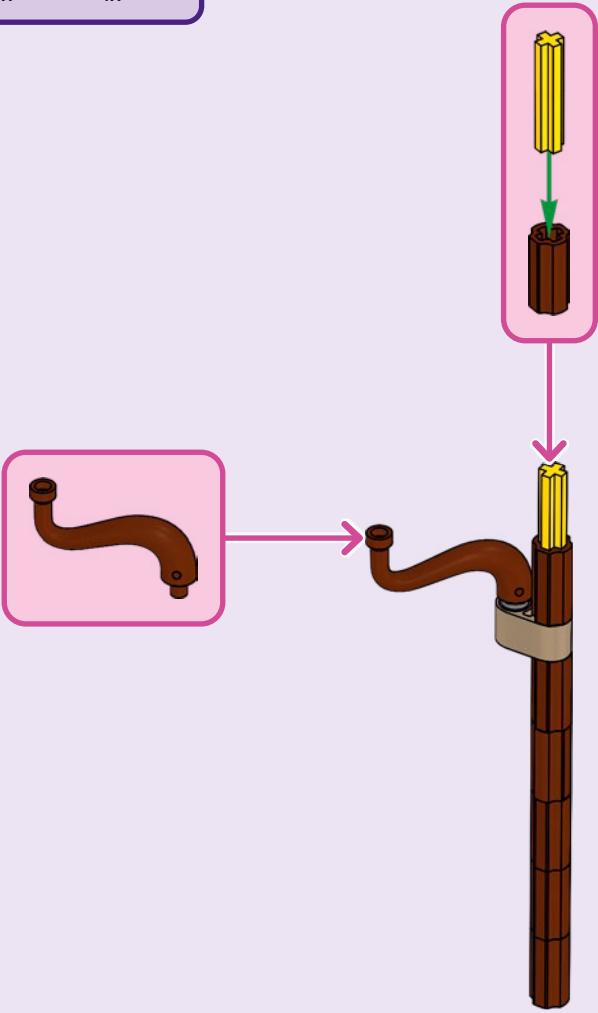

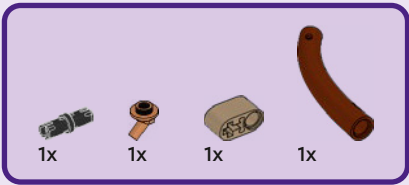

36

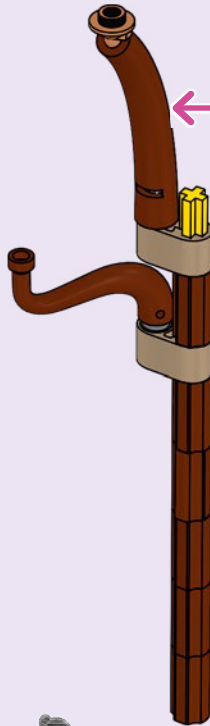
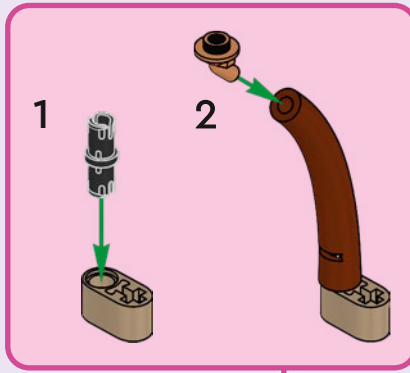

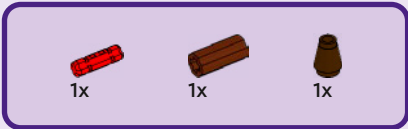

37

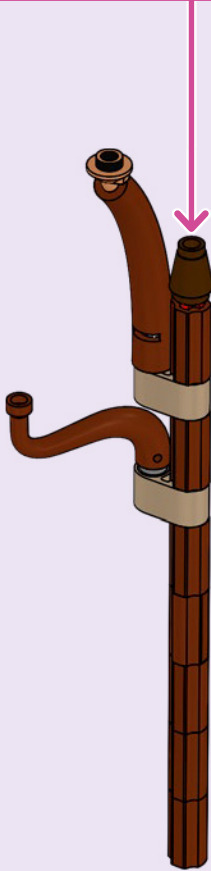
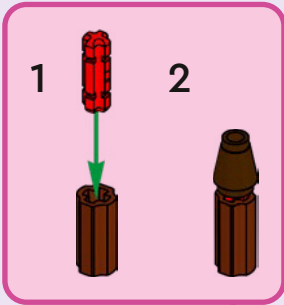

38

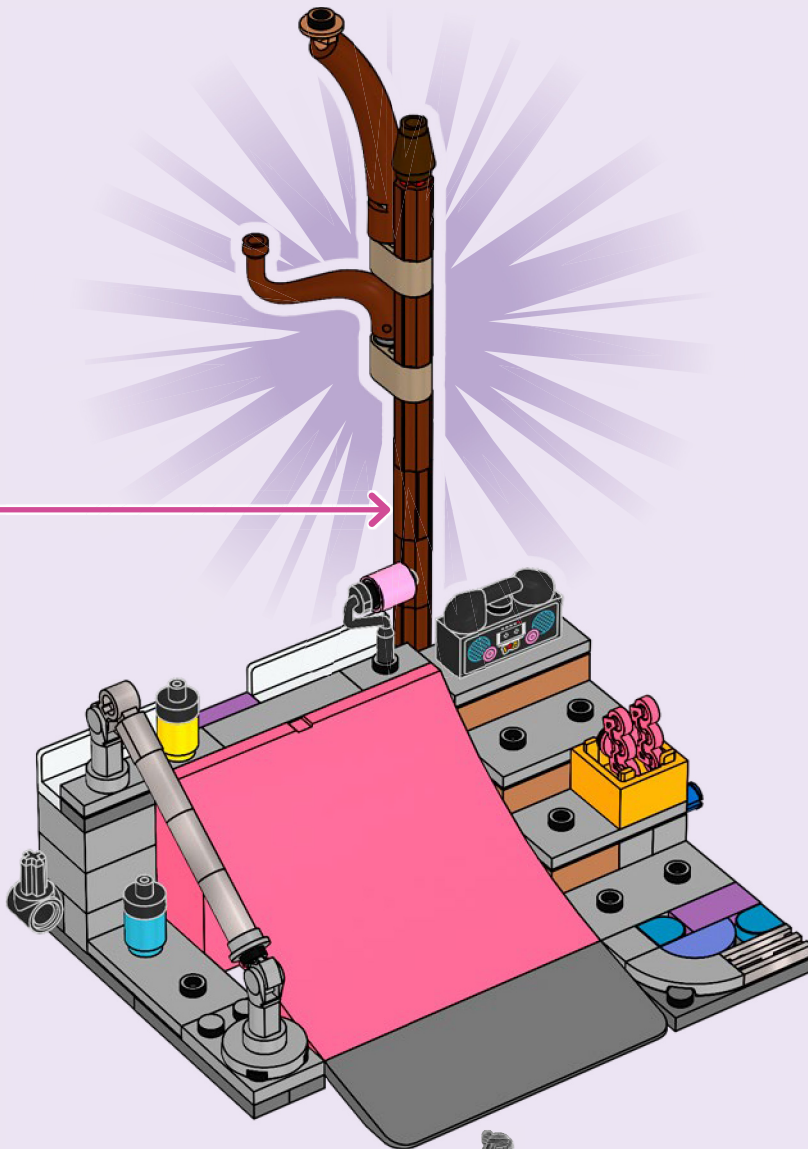

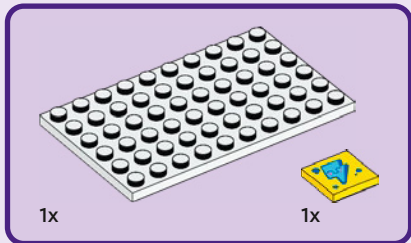

39

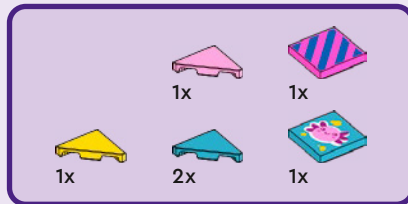
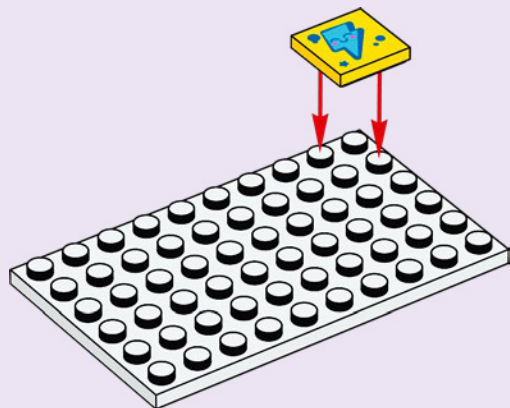

40

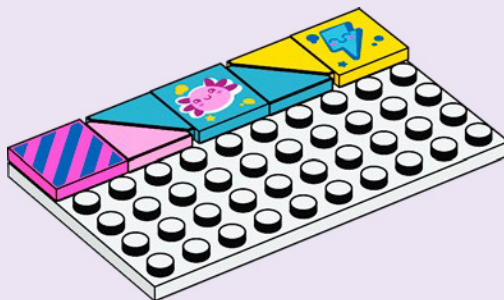



41

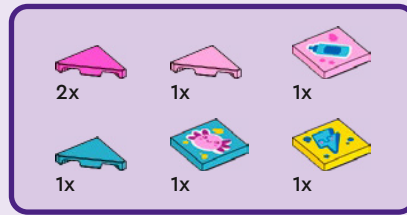

42

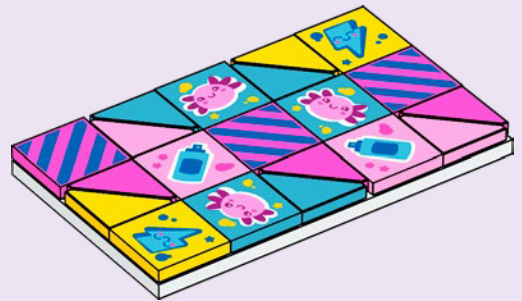

43

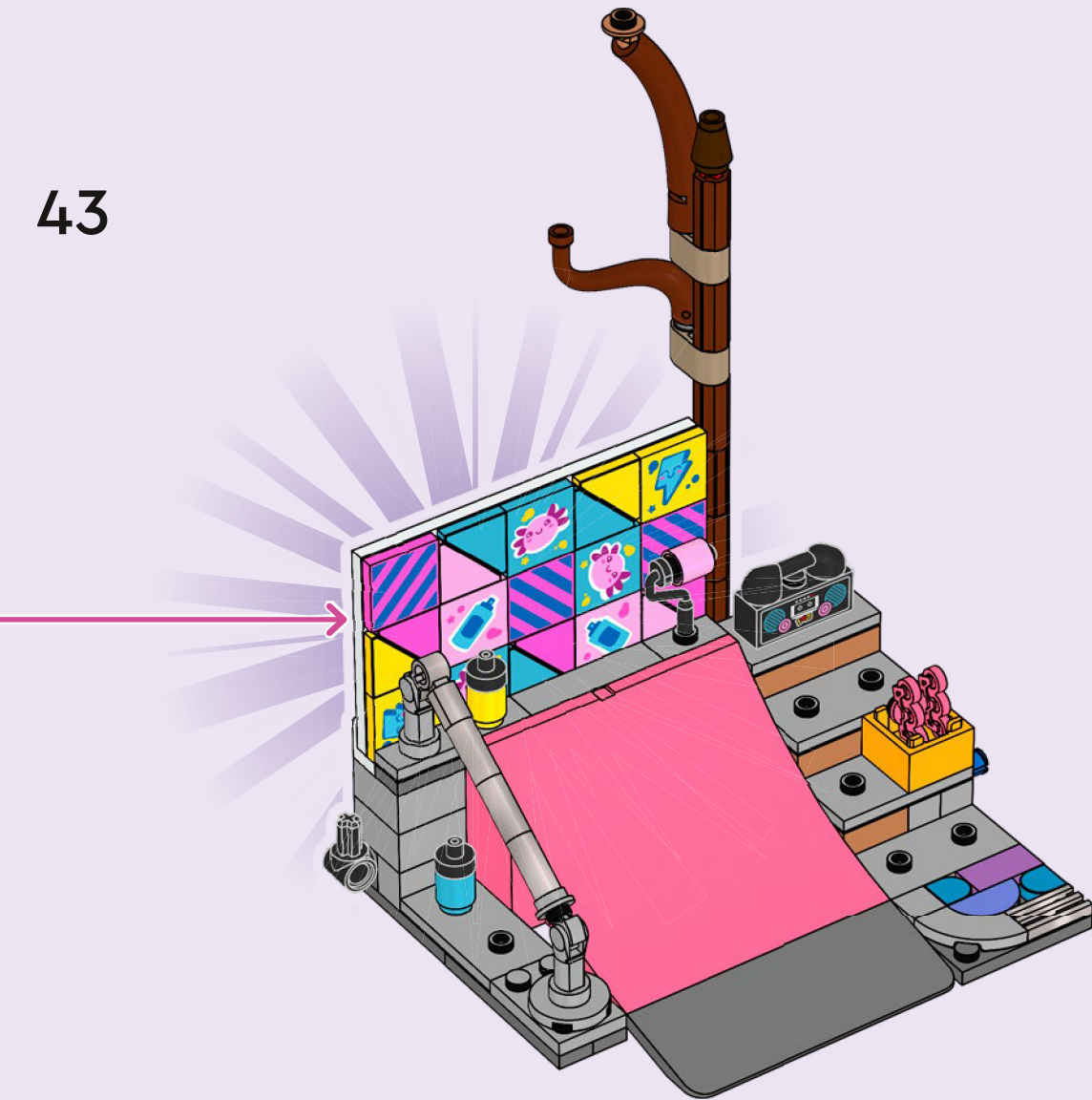

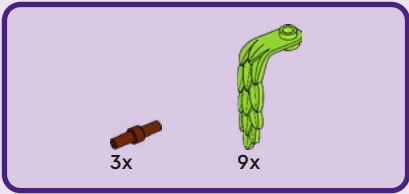

44

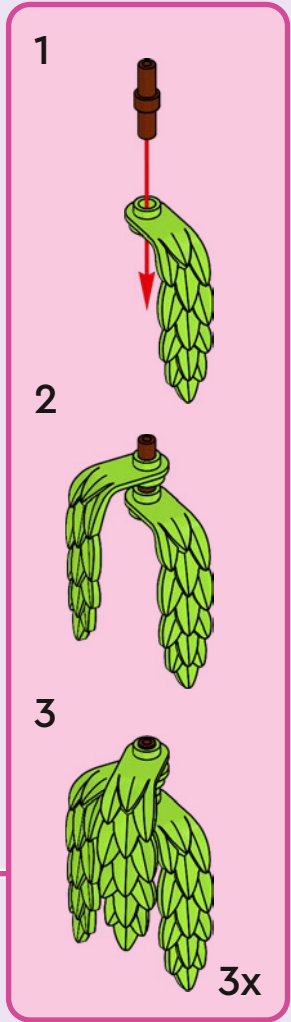

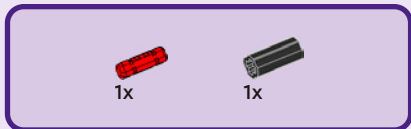
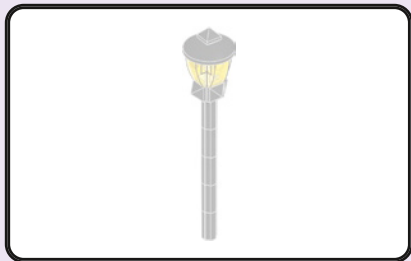

45

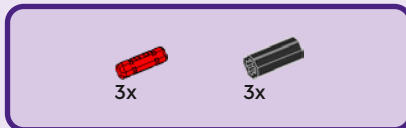

46

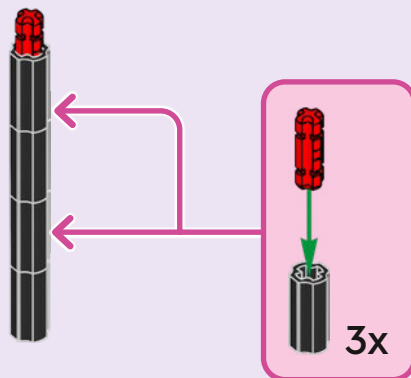

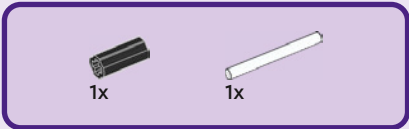

47

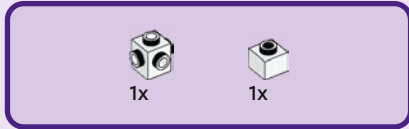
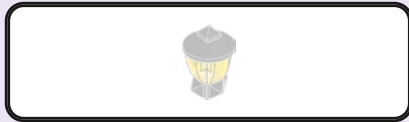

48

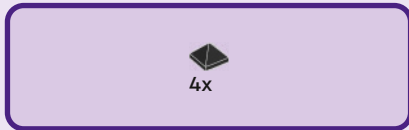

49

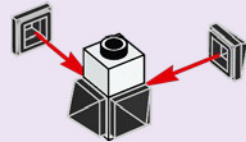



1x

50

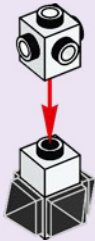

1x

51



4x



4x

52



4x



1x



1x

53



54

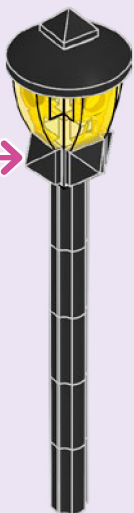

55

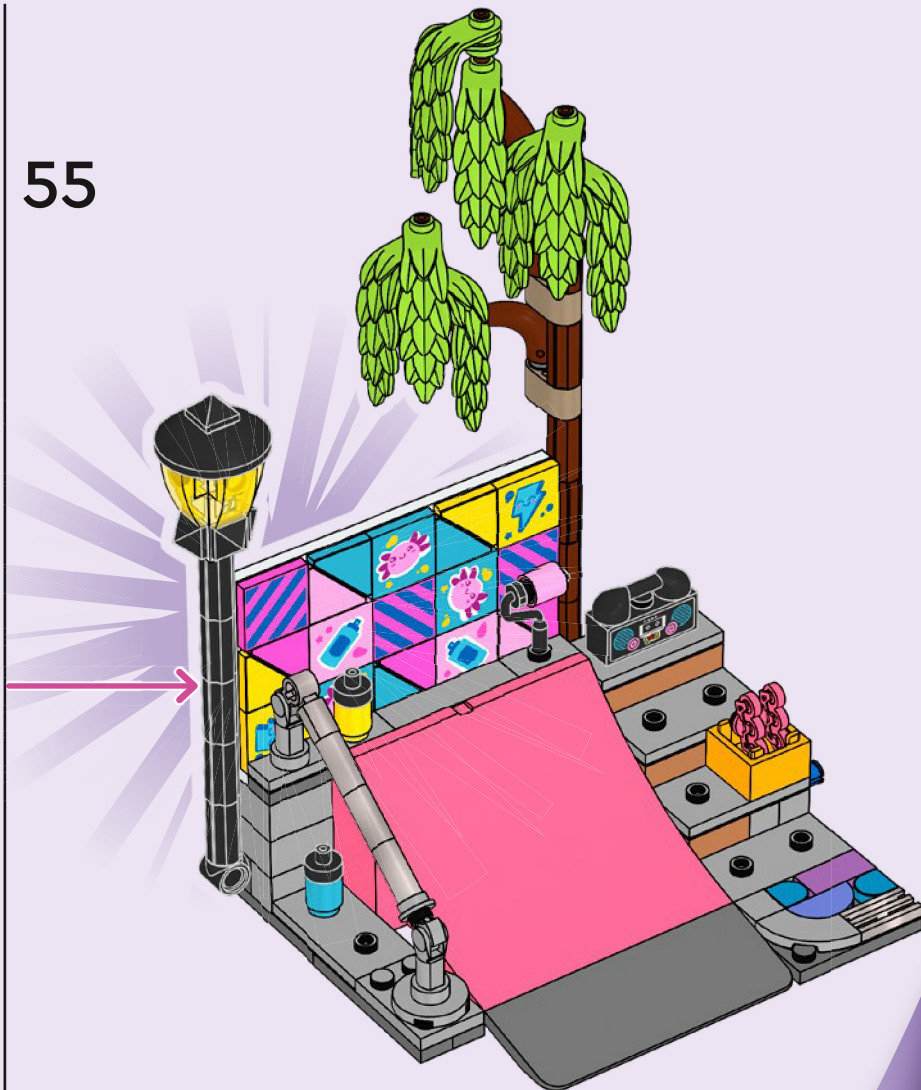

56





