



A MINECRAFT MOVIE

21273



LEGO® Builder



LEGO.com/sustainable-packaging



 ^{FR} **DONNEZ**
OU
RECYCLEZ

 OU  OU 

ASSOCIATION MAGASIN DÉCHÈTERIE

Adresses sur quefairedemesdechets.fr

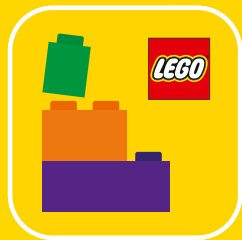

Q LEGO® Builder

BUILDER



Apple and the Apple logo are trademarks of Apple Inc., registered in the U.S. and other countries and regions. App Store is a service mark of Apple Inc. Google Play and the Google Play logo are trademarks of Google LLC. Tencent and the Tencent logo are trademarks of Tencent Inc.

Q [LEGO.com/devicecheck](https://www.lego.com/devicecheck)

EN Ask parents' permission before going online | DE Eltern um Erlaubnis bitten, bevor du online gehst | FR Demande l'autorisation d'un parent avant d'aller en ligne | IT Chiedi il permesso ai tuoi genitori prima di andare online | ES Pídeles permiso a tus papás antes de conectarte a Internet | PT Pede autorização aos pais antes de acederes online | ZH 上网前应先征得父母的同意 | PL Poproś rodziców o zgodę, zanim wejdiesz do Internetu | CS Než půjdeš na internet, požádej rodiče o svolení | SK Skôr než pôjdeš na internet, vypýtaj si povolenie od rodičov | HU Kérj szülői engedélyt, mielőtt online csatlakoznál! | RO Cere permisiunea părinților înainte de a te conecta online | BG Поискайте разрешение от родител, преди да влезете онлайн | LV Pirms došanās tiešsaistē palūdz atļauju vecākiem | ET Enne Interneti kasutamist küsi vanematelt luba | LT Prieš prisijungdami prie interneto, atsiklauskite tėvų

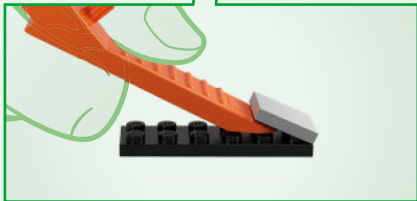
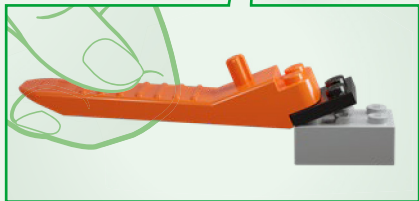
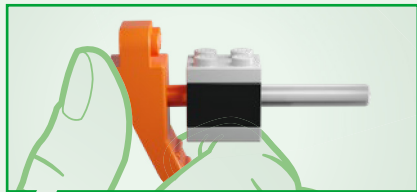
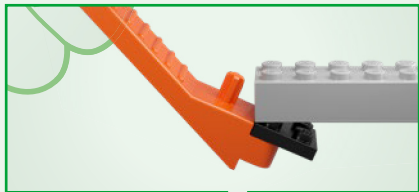

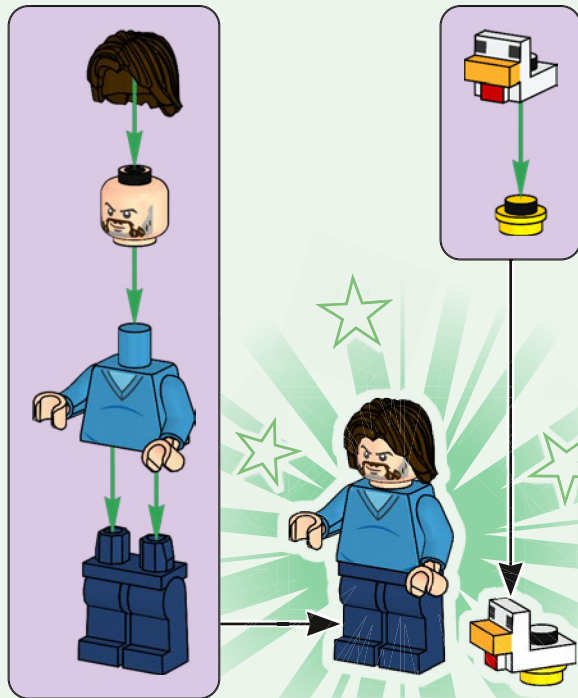

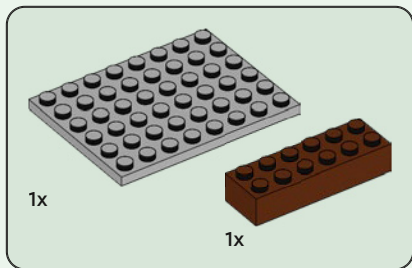

1

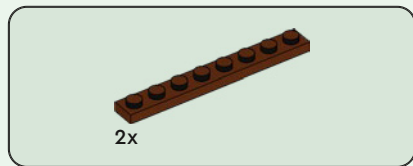
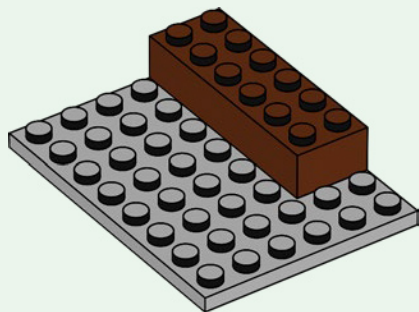

2

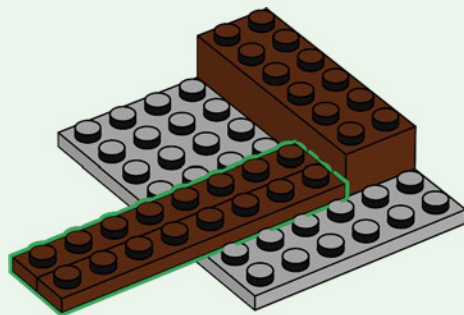

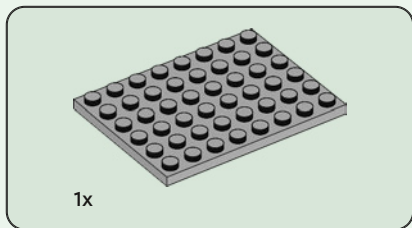

3

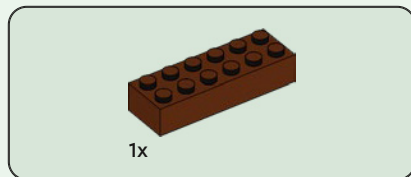
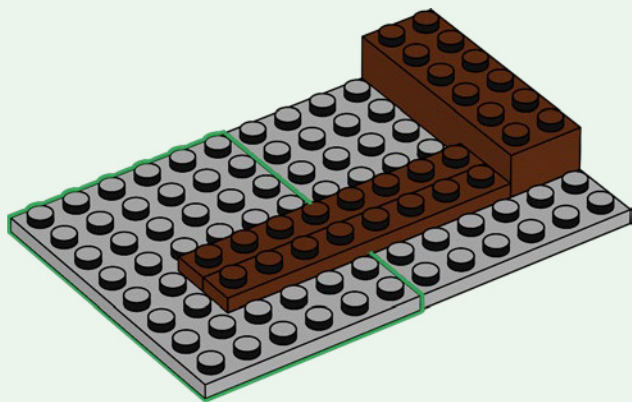

4

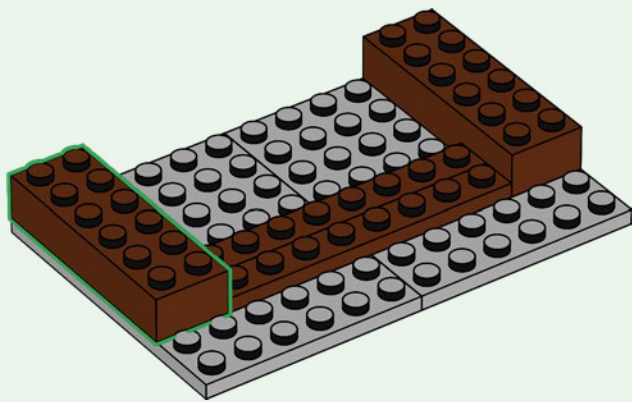

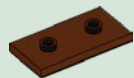

4x

5

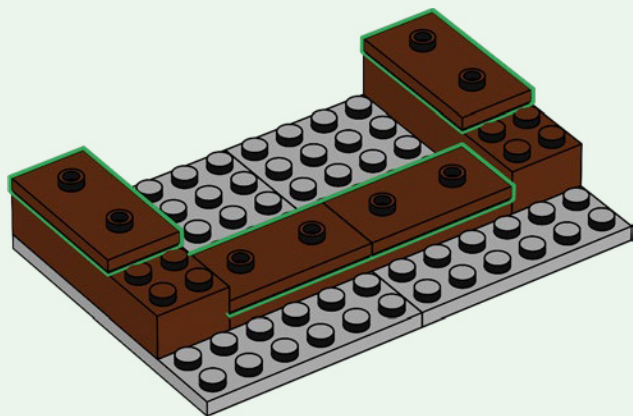

2x

6

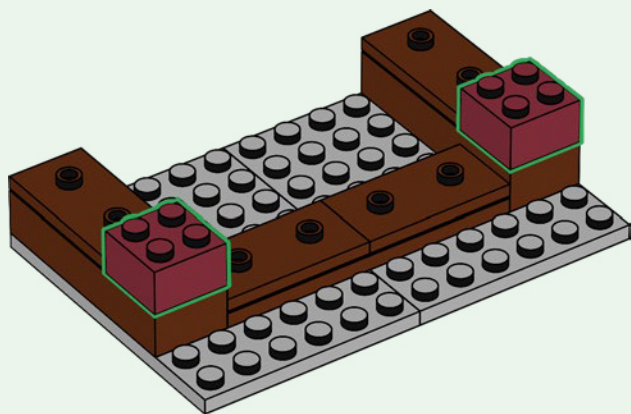

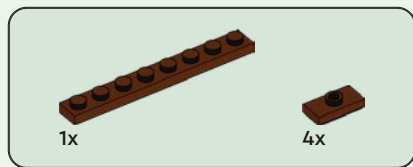

7

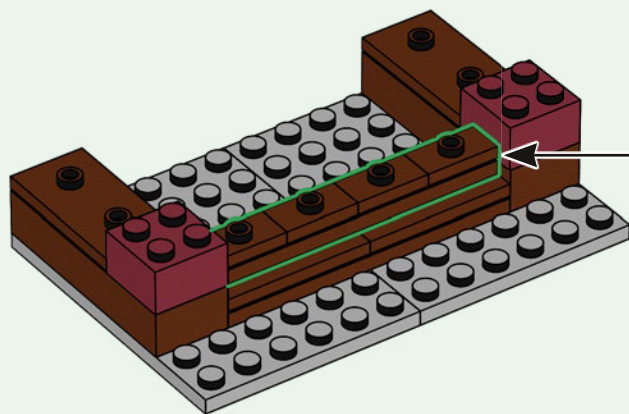
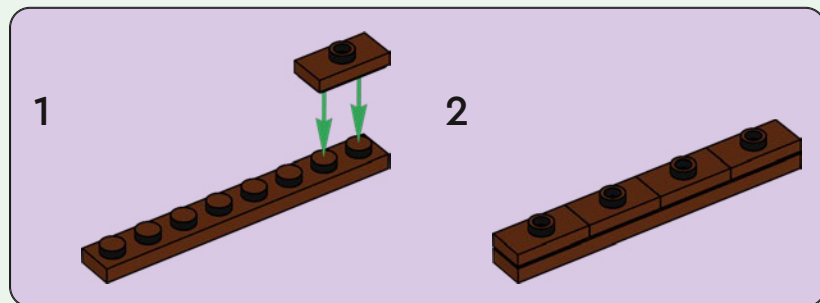



2x

8

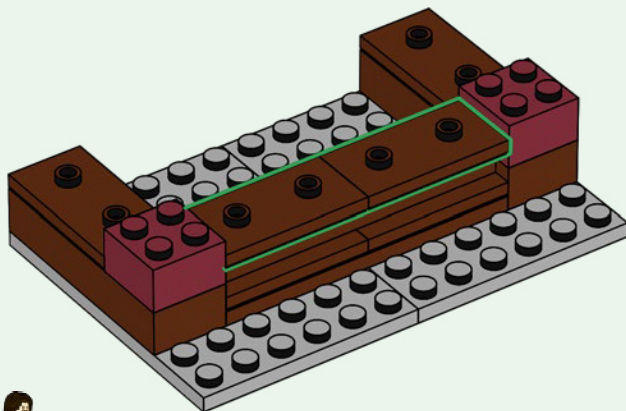

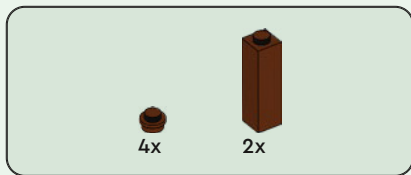

9

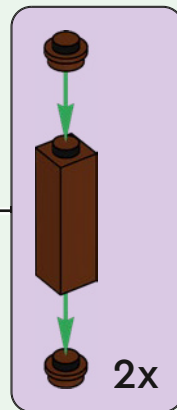
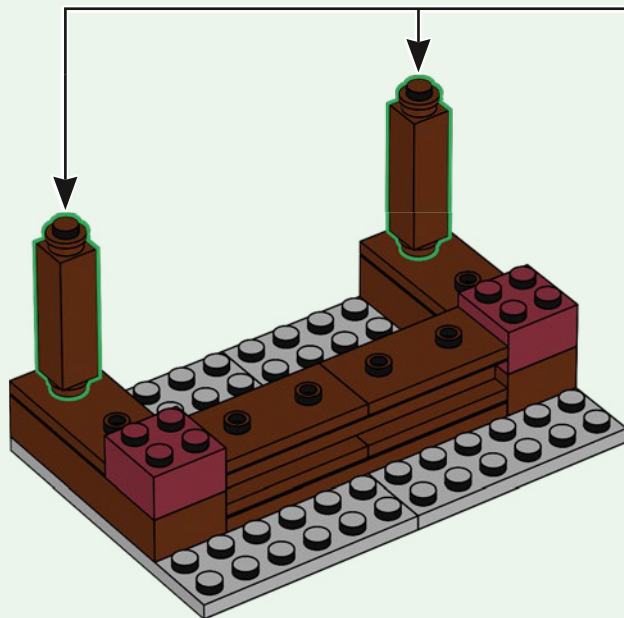



2x



2x



4x



2x



2x

10

1

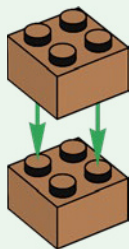

2



3



2x



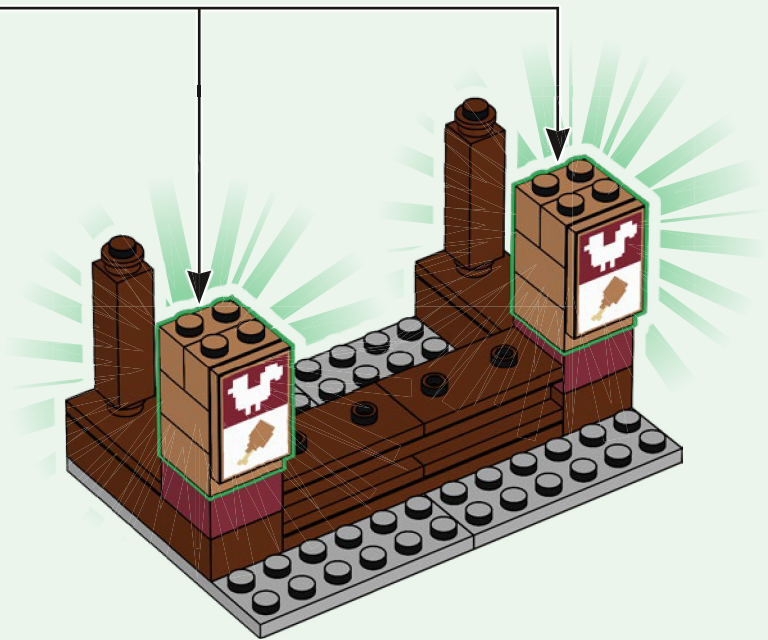



11

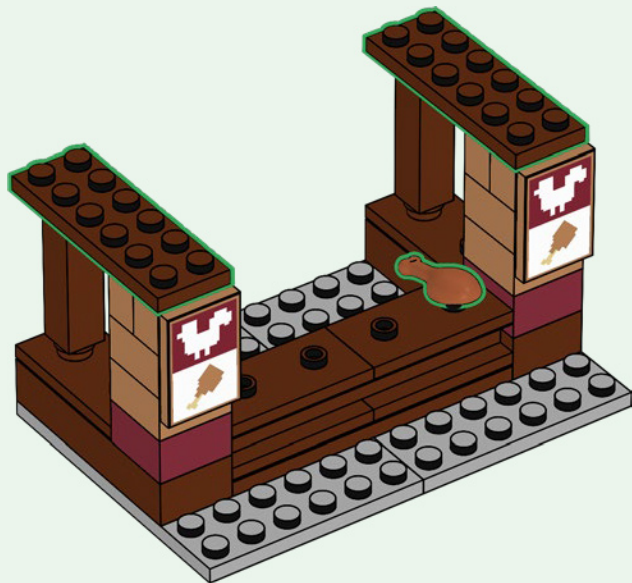

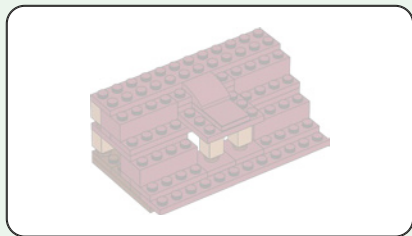

12

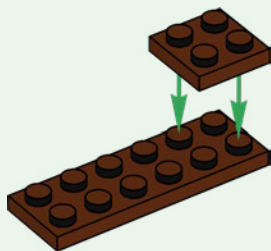

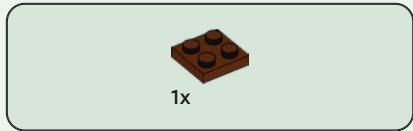

13

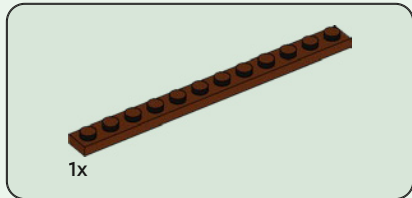
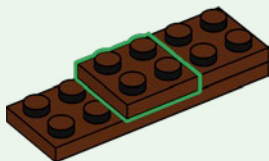

14

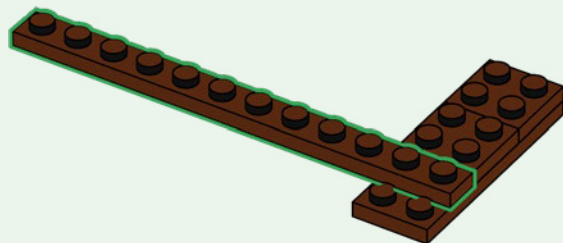

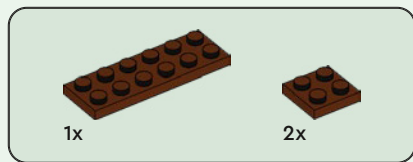

15

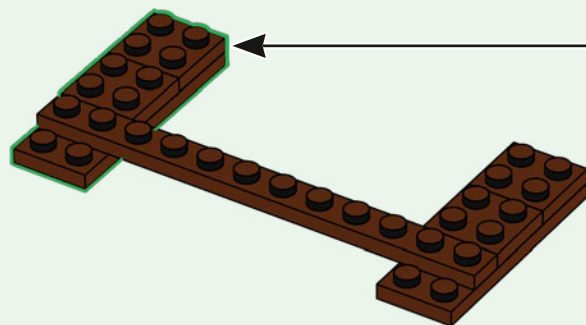
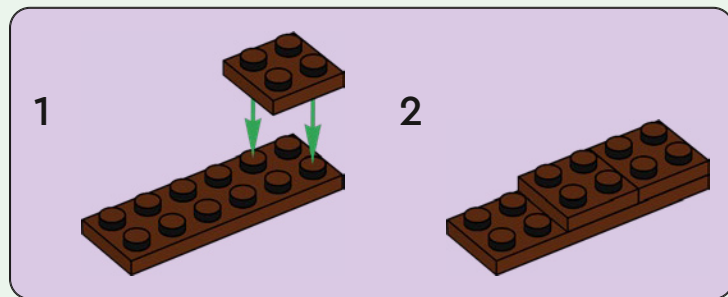



2x

16



2x

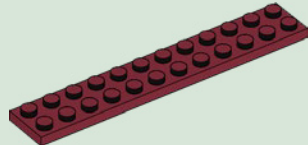
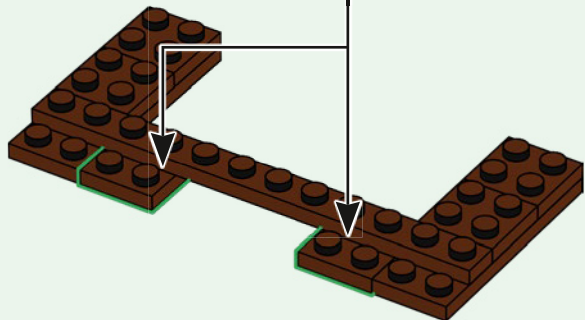

1x

17

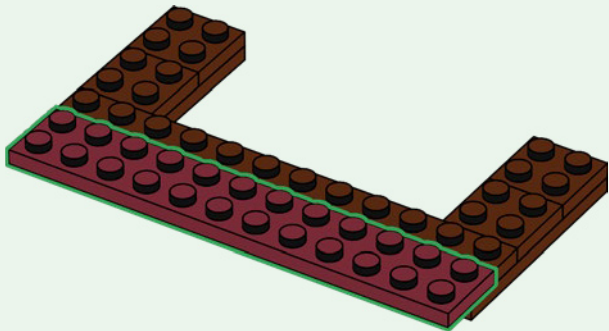

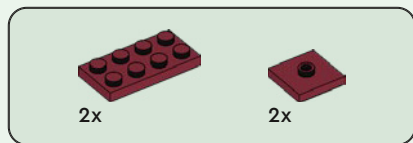

18

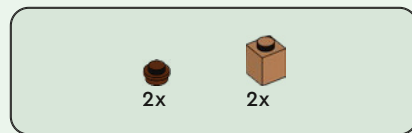
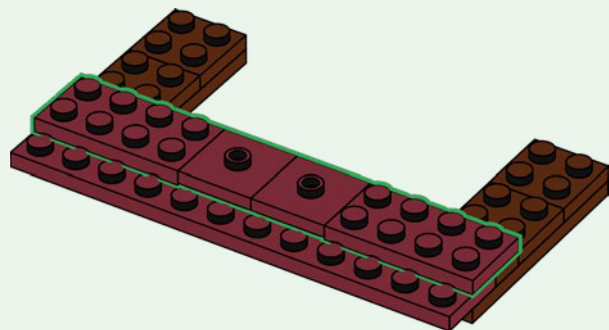

19

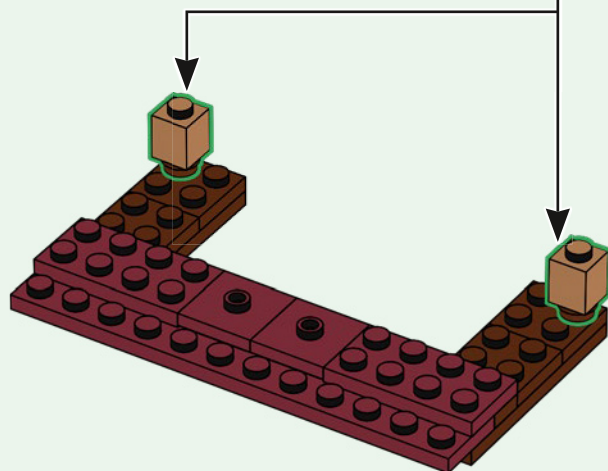
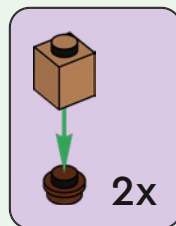



4x

20

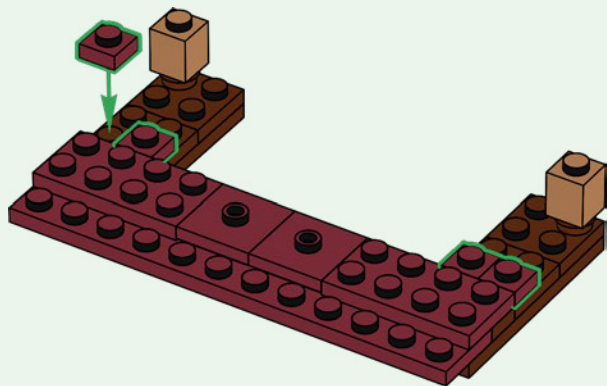

2x

21

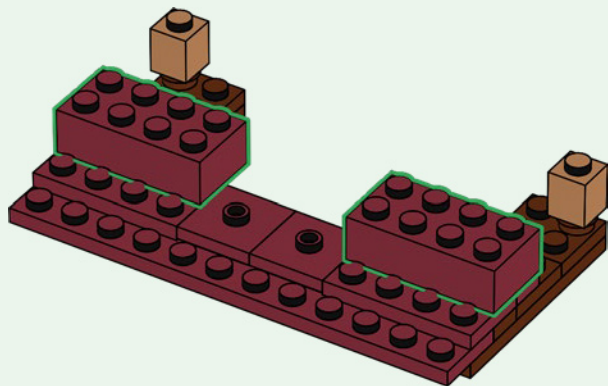

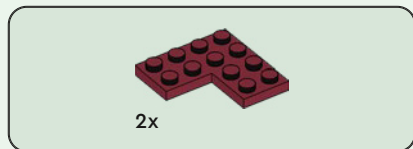

22

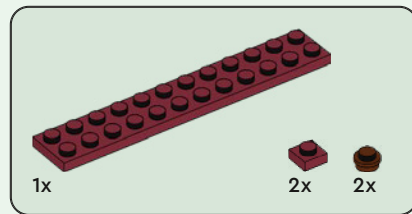
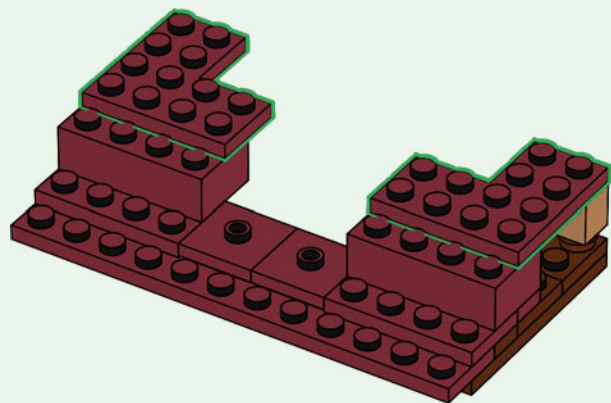

23

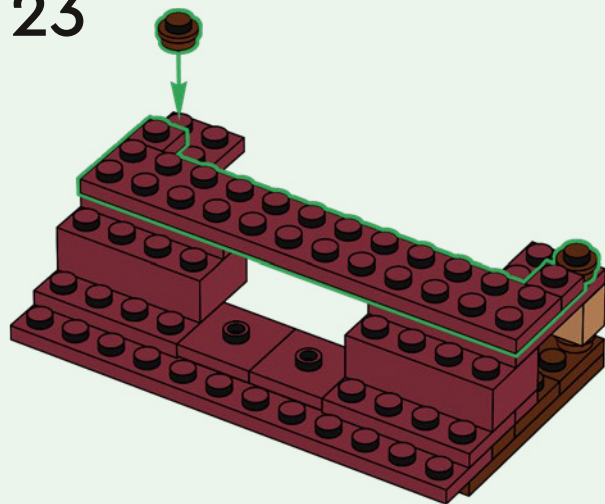



4x



2x

24

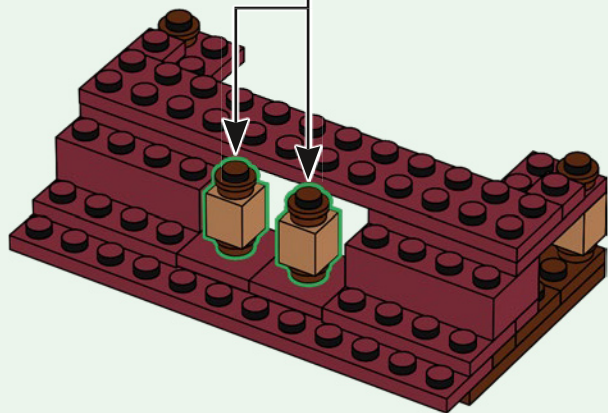
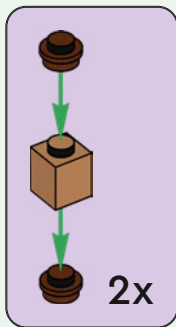



1x

25

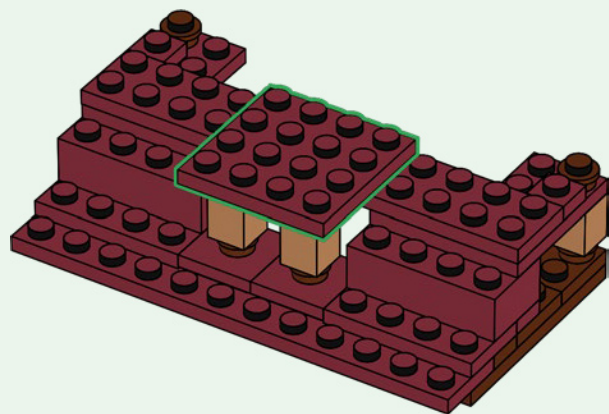

1x

26

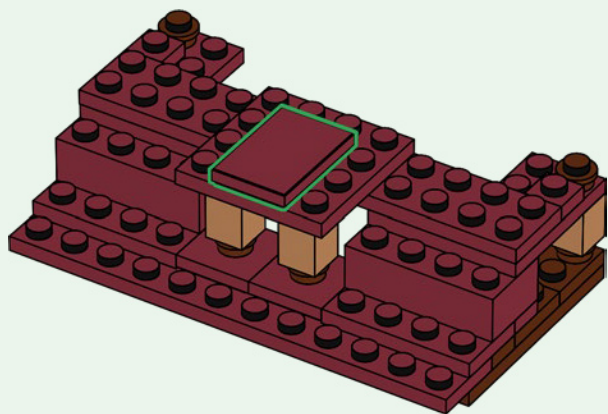



2x

27

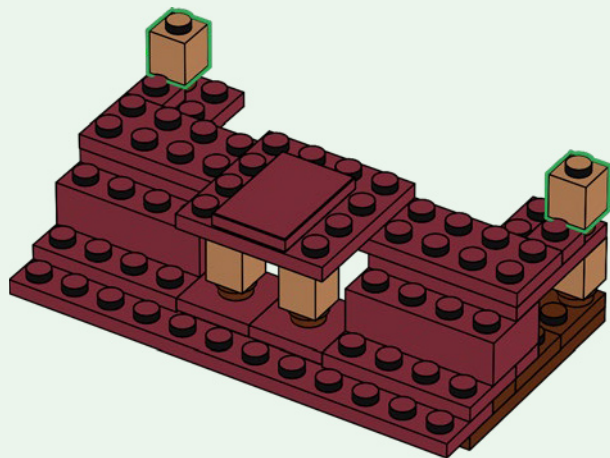

2x

28

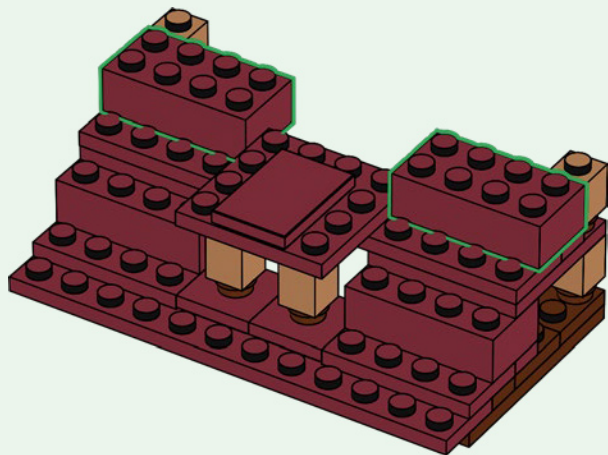

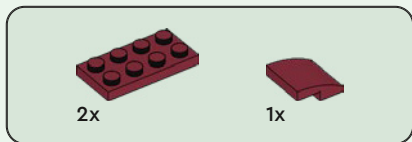

29

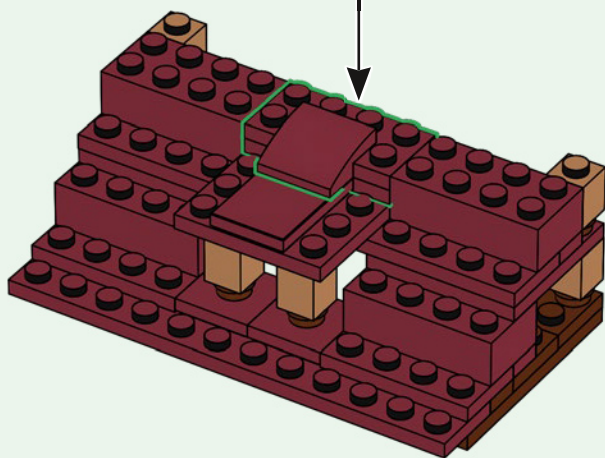
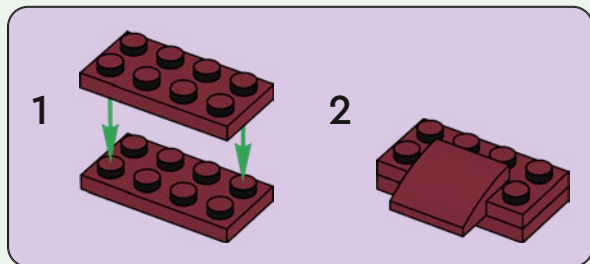

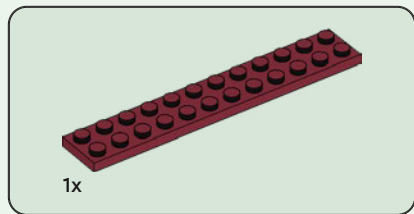

30

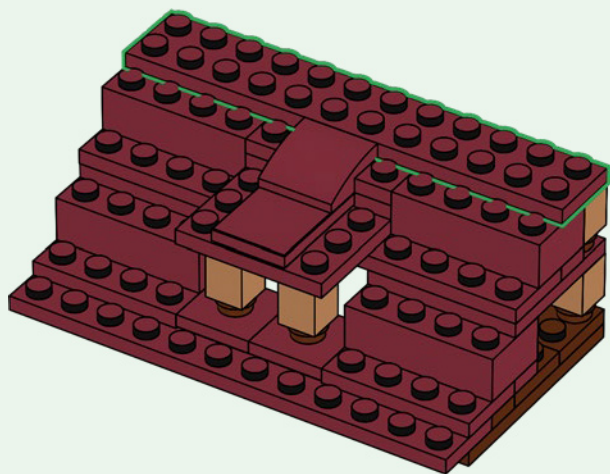

31

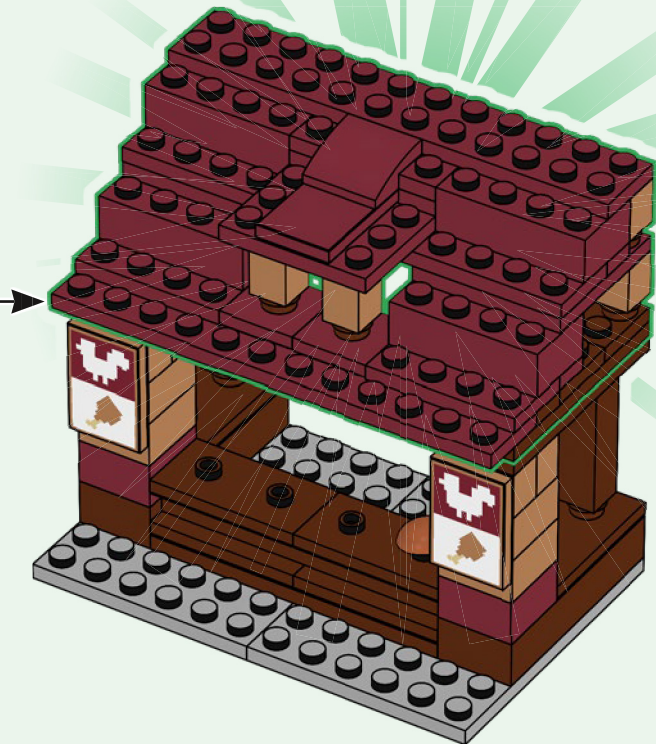

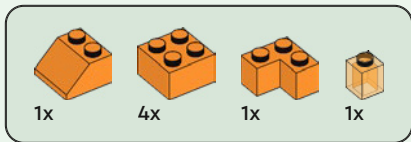

32

1

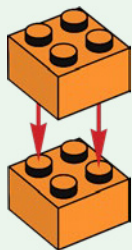

2

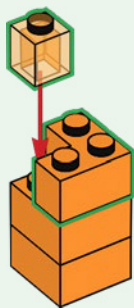

3

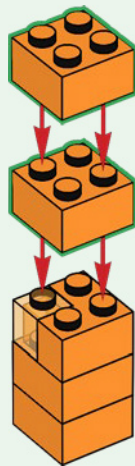

4

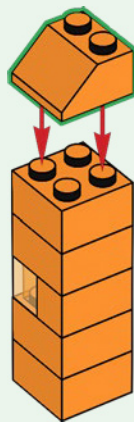

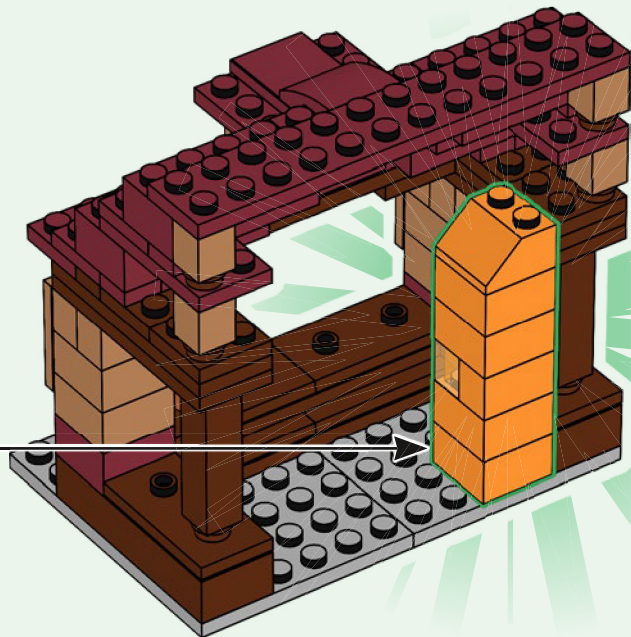

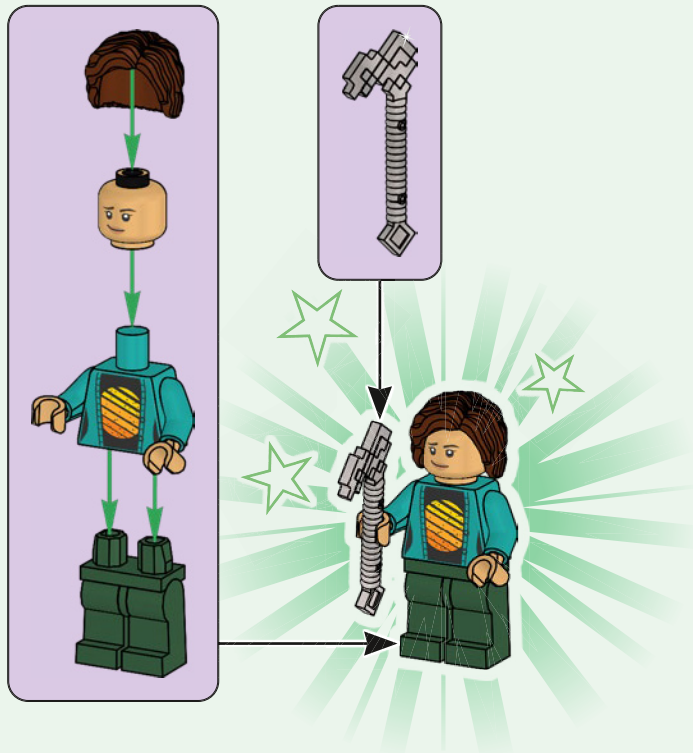

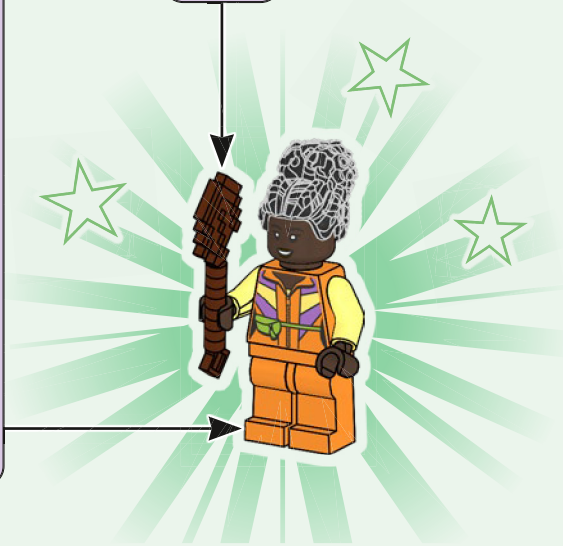
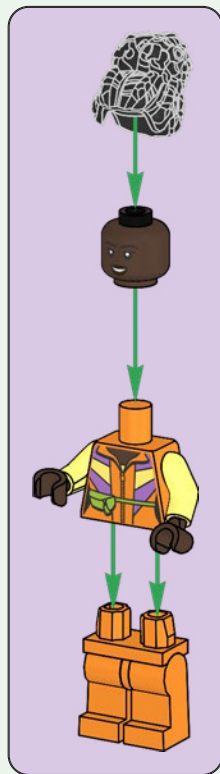

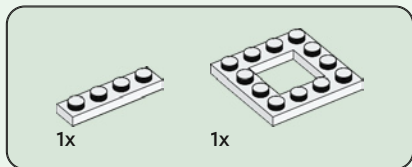
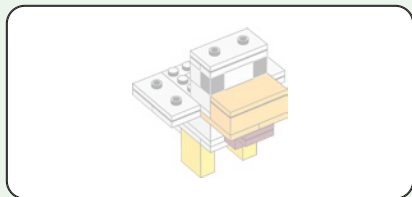

33

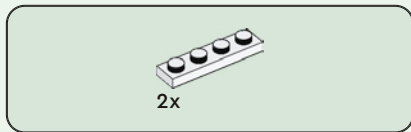
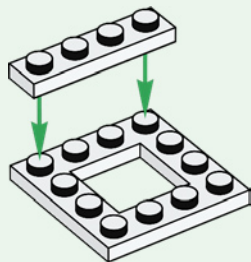

34

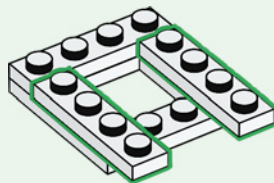

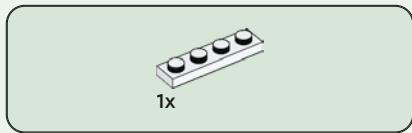

35

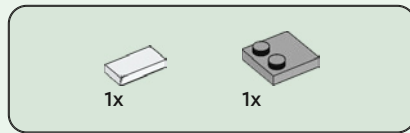
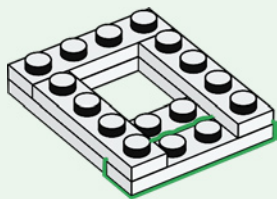

36

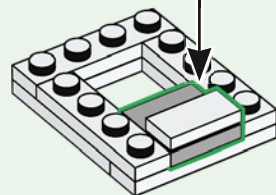
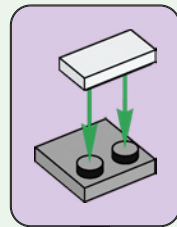

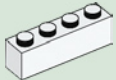

3x

37

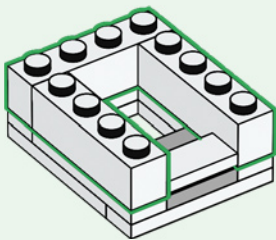

1x

38

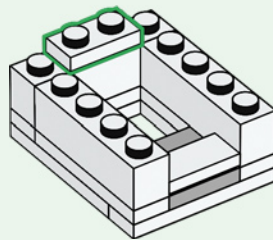

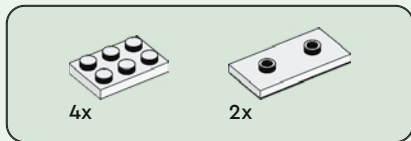

39

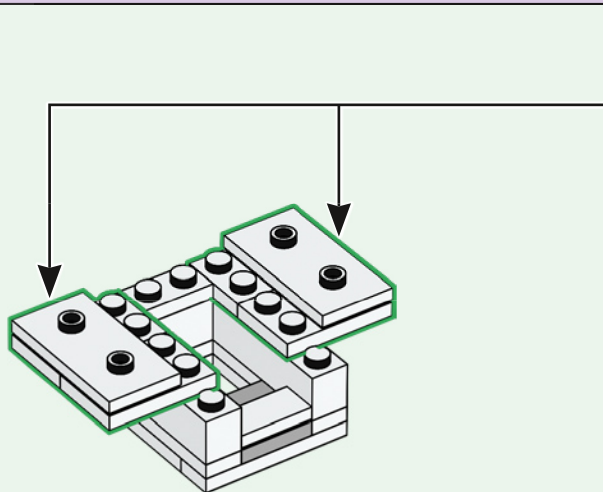
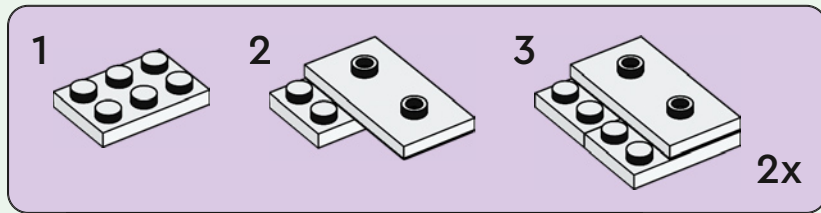

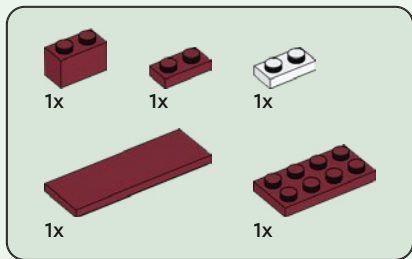

40

1



2

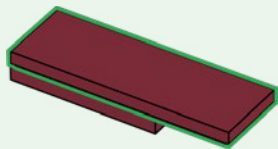

3

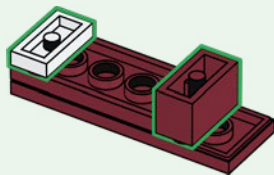

4

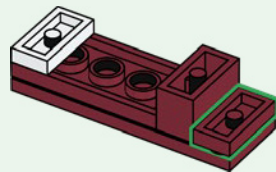

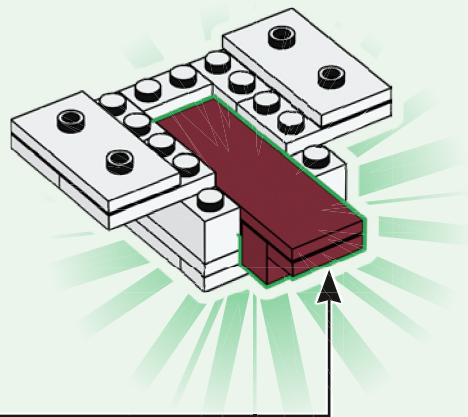

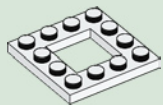

1x

41

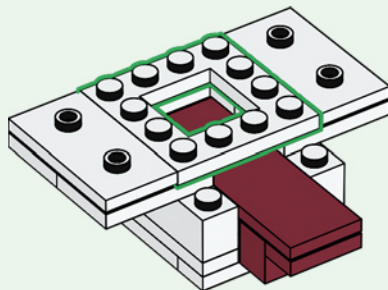

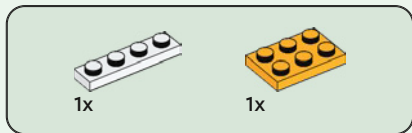
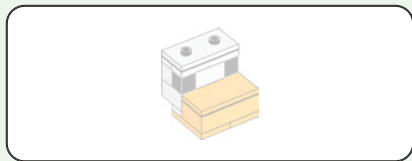

42

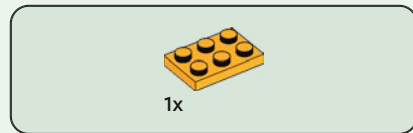
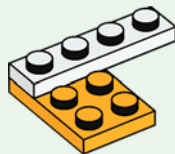

43

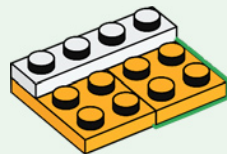

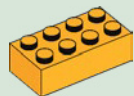

1x

44

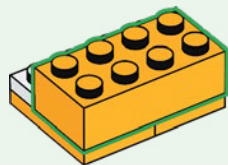

1x

45

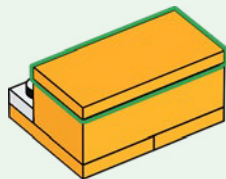

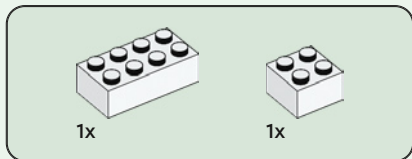
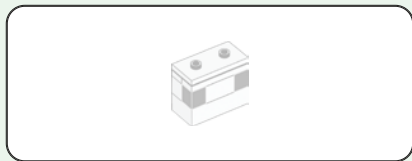

46

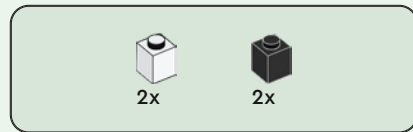
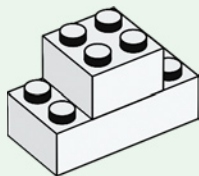

47

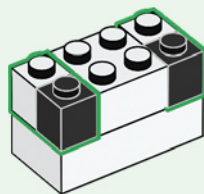



2x

48

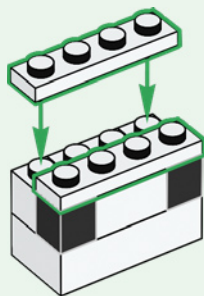

1x

49

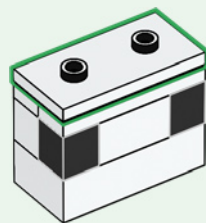

50

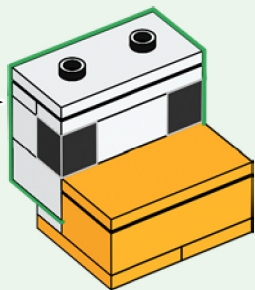

51

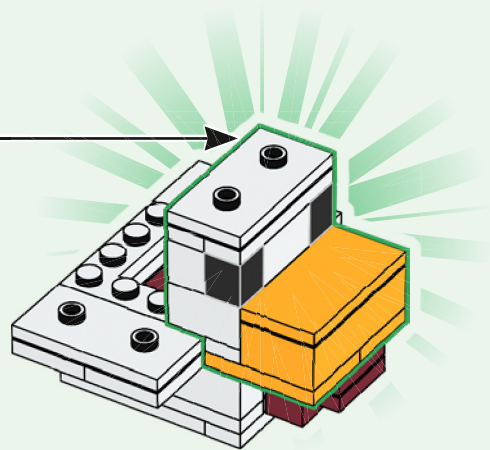



2x

52

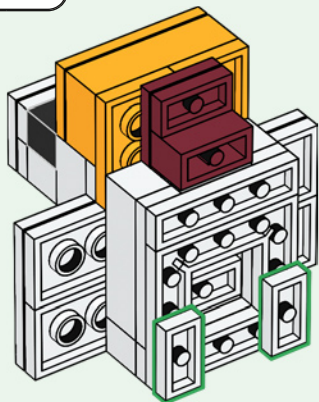

2x

53

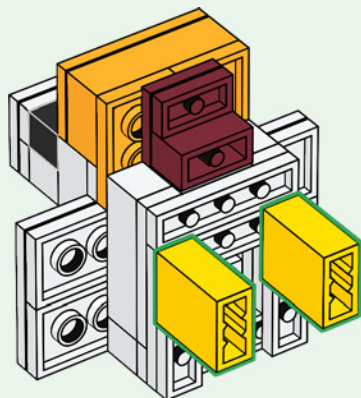

54

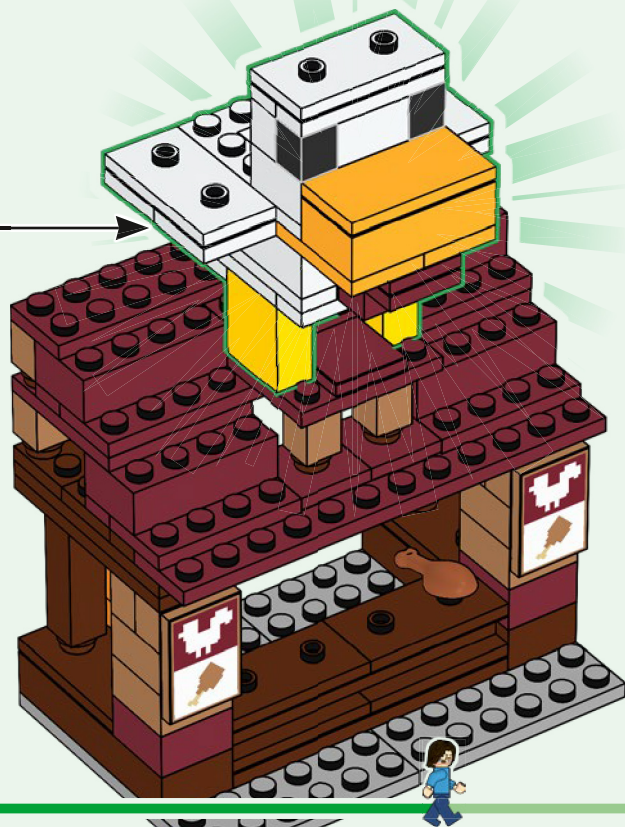



1x

55

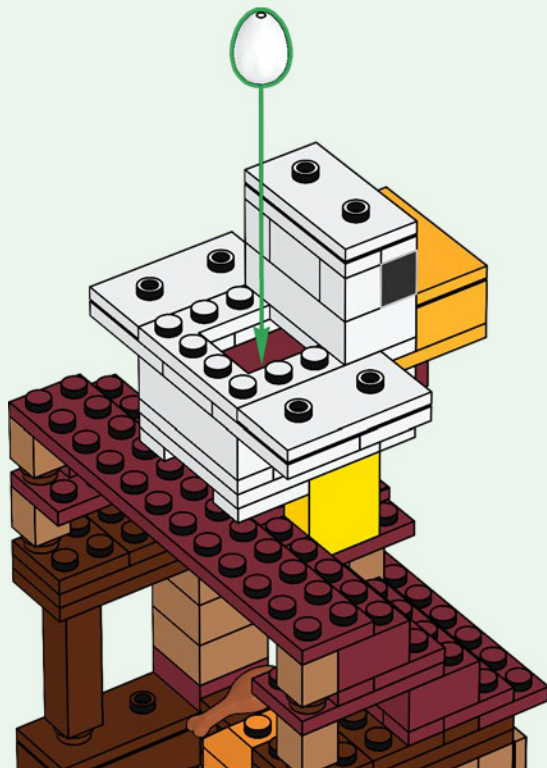

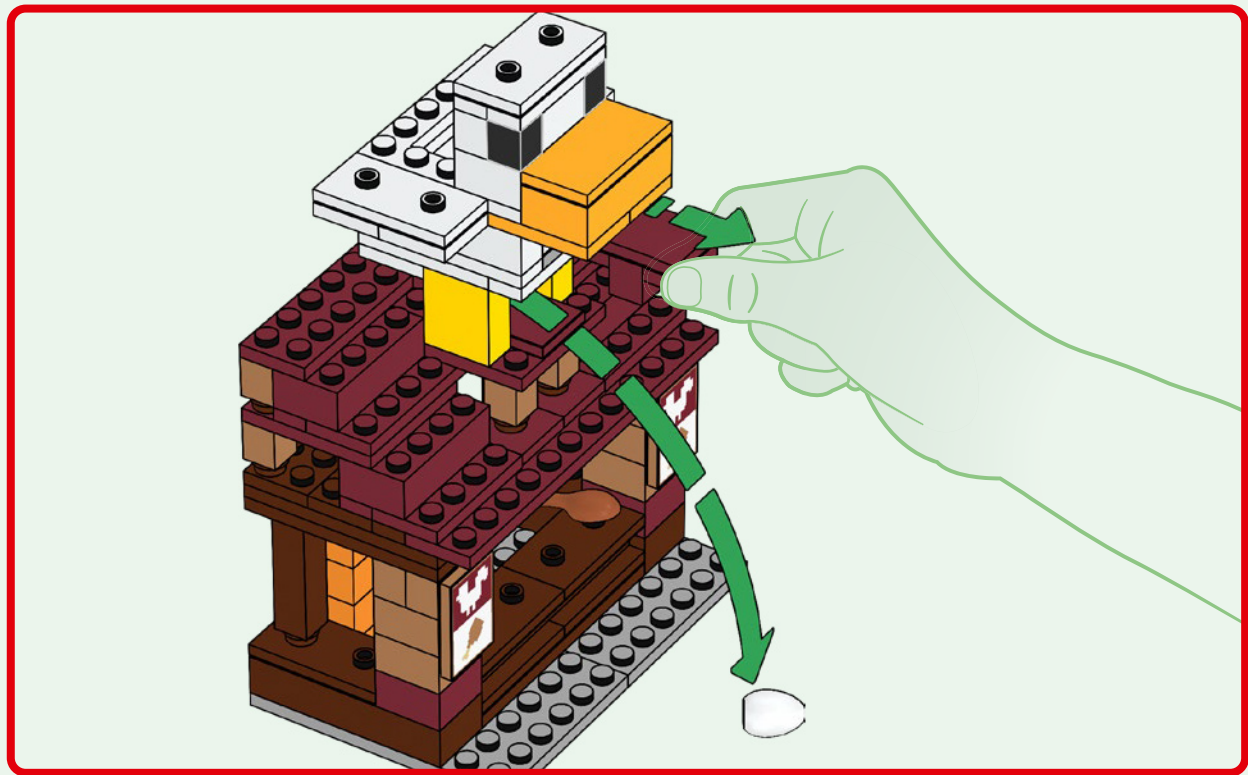

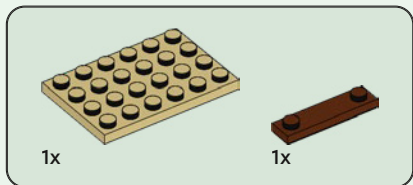
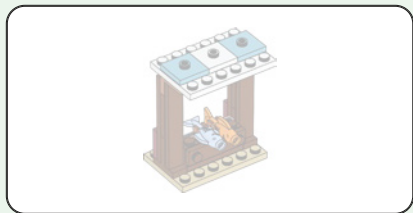

1

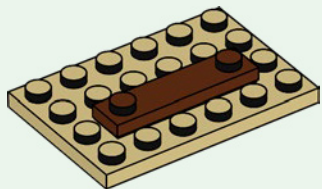

2

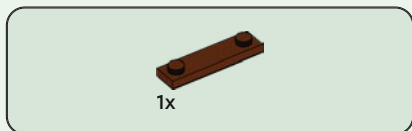
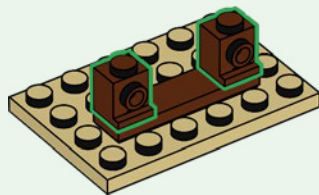

3

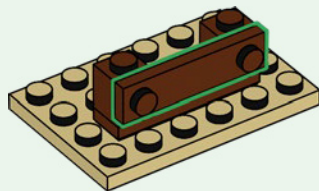

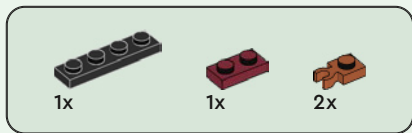

4

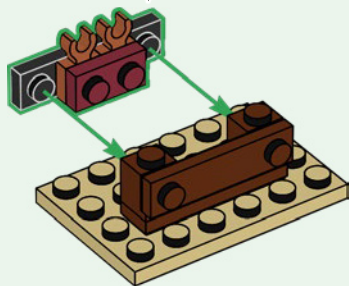
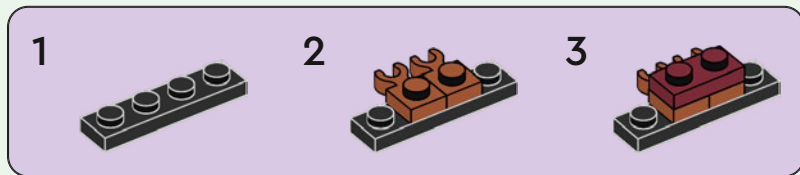



2x



2x



2x



2x



2x



2x



2x

5

1

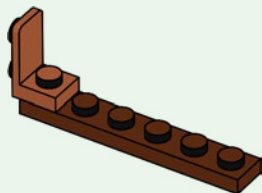

2

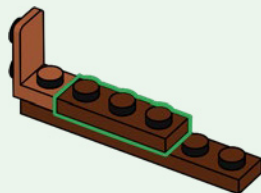

3

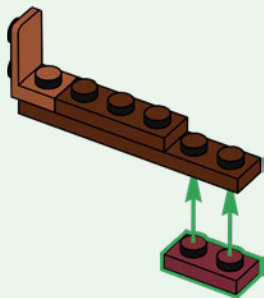

4

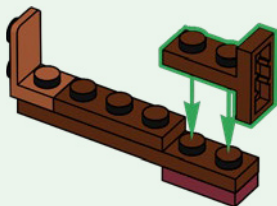

5

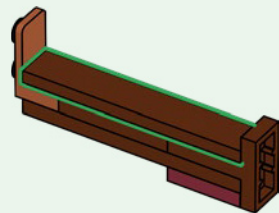

2x



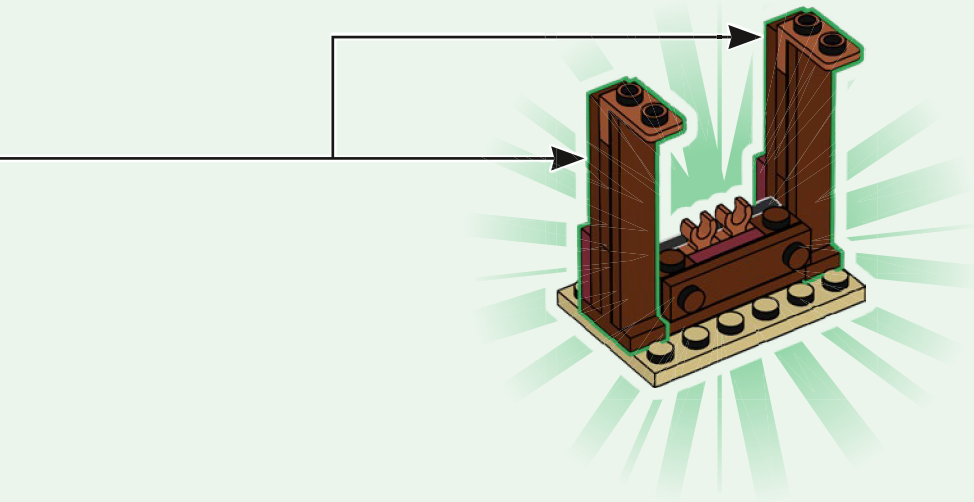

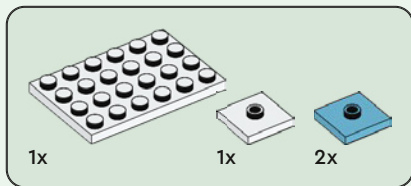

6

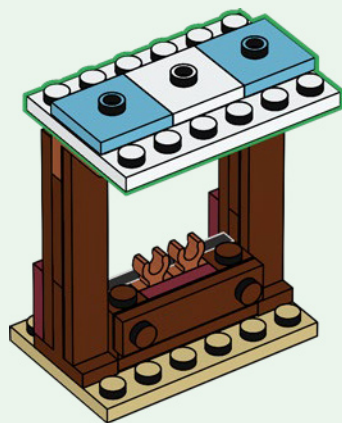
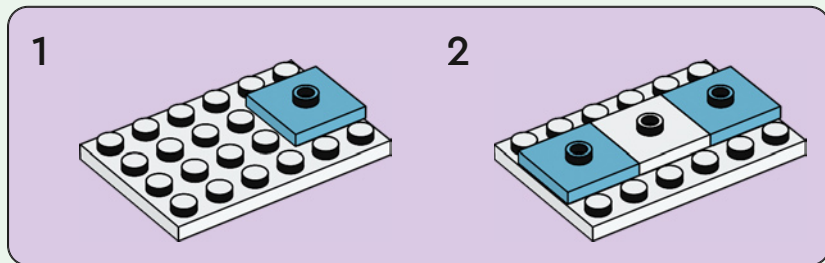



1x



1x

7

