

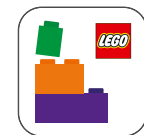

10359



Booklet available in English  
Heft in deutscher Sprache erhältlich  
Livret disponible en français  
Libretto disponibile in italiano  
Folleto disponible en español  
如需中文版手册



LEGO® Builder





LEGO.com/sustainable-packaging



FR  
**DONNEZ  
OU  
RECYCLEZ**



ASSOCIATION

OU



MAGASIN

OU



DÉCHÈTERIE

Adresses sur [quefairedemesdechets.fr](http://quefairedemesdechets.fr)



# BUILDER



Apple and the Apple logo are trademarks of Apple Inc., registered in the U.S. and other countries and regions. App Store is a service mark of Apple Inc. Google Play and the Google Play logo are trademarks of Google LLC. Tencent and the Tencent logo are trademarks of Tencent Inc.

LEGO.com/devicecheck



LEGO® Builder

# Building serenity

Allow yourself to be whisked away to a serene, tranquil garden and, please, stay as long as you like. Maybe you feel inspired to nurture your creative roots or cultivate your own little corner of mindful activity and reflection. This is your space. We hope you will feel right at home among the thriving flora and wildlife by the fountain. You might recognise some of them from your own garden or a familiar place you have visited on a treasured trip to your dream destination.

Every element is as authentic to the area, culture and architecture as possible. The gorgeous decorative tiles are inspired by *zellij* tiles, which influenced building traditions in North Africa and Southern Europe throughout history and add a gorgeously vivid atmosphere to buildings, interior decorations and gardens. We also decided to introduce a new addition to the LEGO® moths and butterflies collection with the mesmerisingly green Spanish moon moth. You can breathe new life into your garden as you move plants to different locations to suit your mood or let them take turns soaking up the sun or cooling down in the shade. You can even move around larger parts of the model to create different shapes and expressions.



“Bring this idyllic Fountain Garden to life  
– and a tiny bit of summer atmosphere into  
your home, all year round.”

– The LEGO® Design Team







The life in  
your garden





1 *Pelophylax perezi*  
Iberian waterfrog



2 *Emberiza citrinella*  
Yellowhammer



3 *Graellsia isabellae*  
Spanish moon moth



4 *Pelargonium x hortorum*  
Red garden geranium



5 *Bougainvillea*  
Pink bougainvillea flower

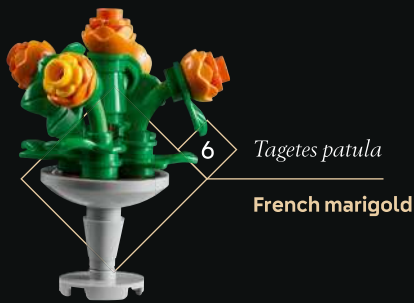

6 *Tagetes patula*  
French marigold

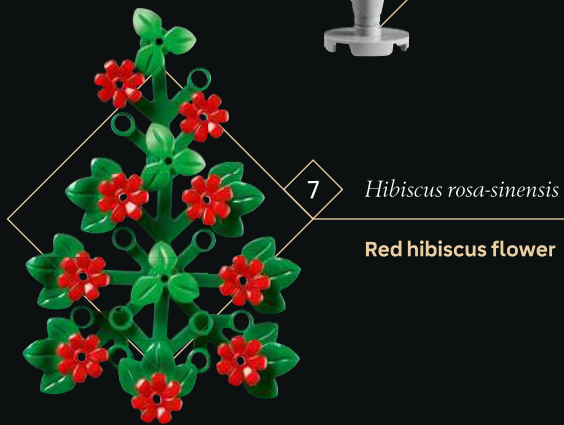

7 *Hibiscus rosa-sinensis*  
Red hibiscus flower

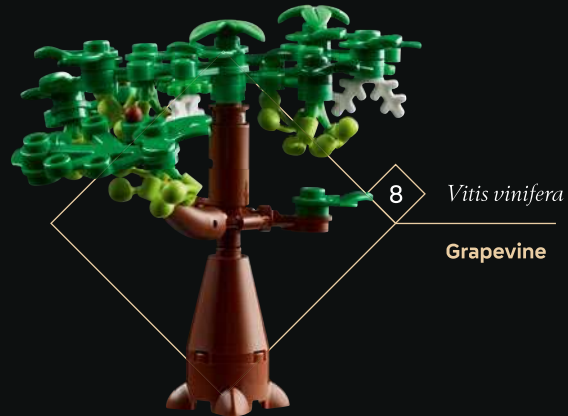

8 *Vitis vinifera*  
Grapevine



9 *Petunia axillaris*  
White petunia

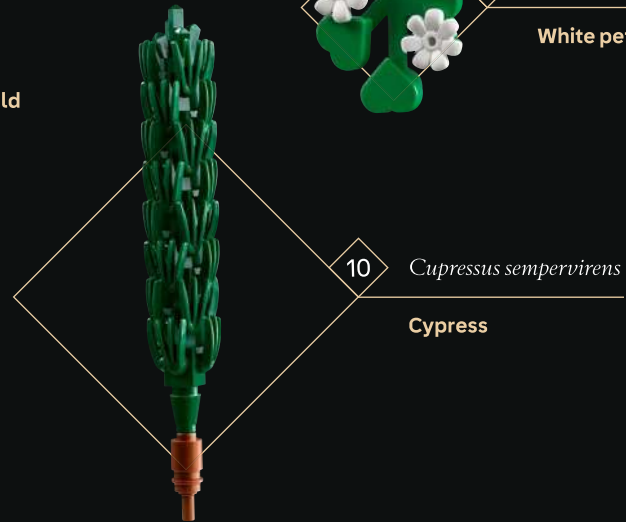

10 *Cupressus sempervirens*  
Cypress



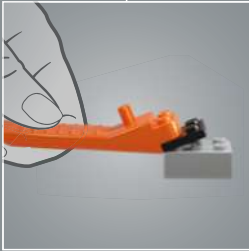
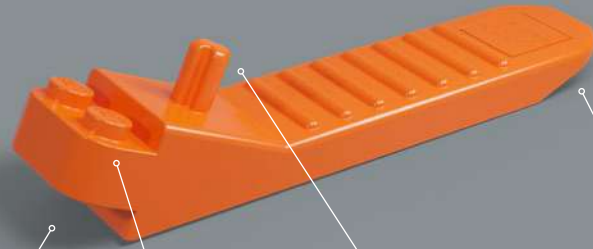



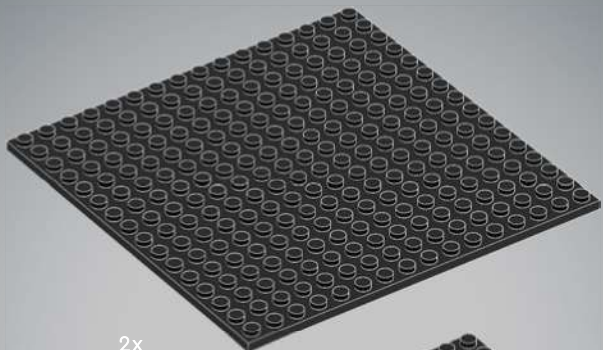

2x



1x

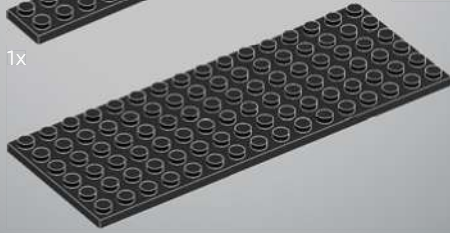

2x

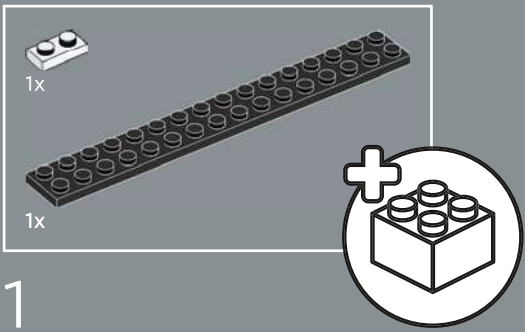

1

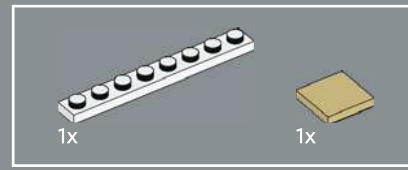
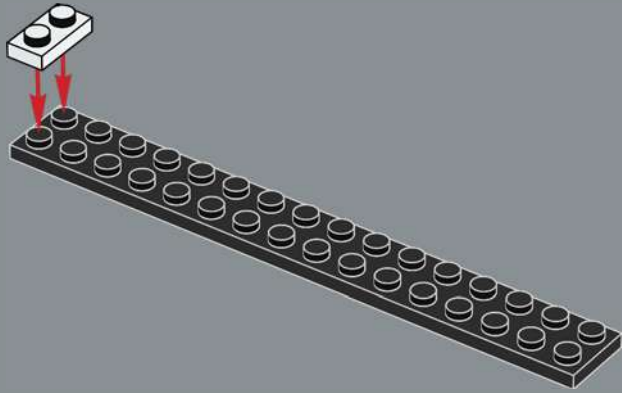

2

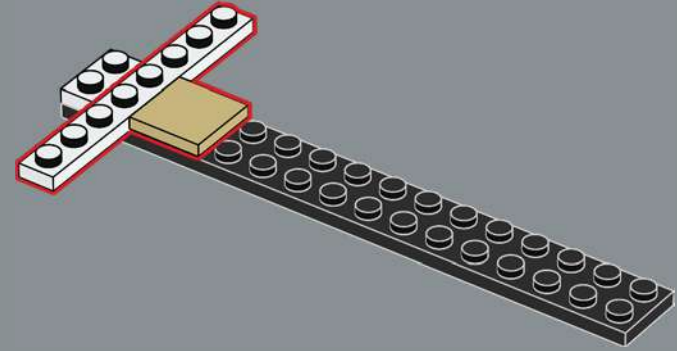

3

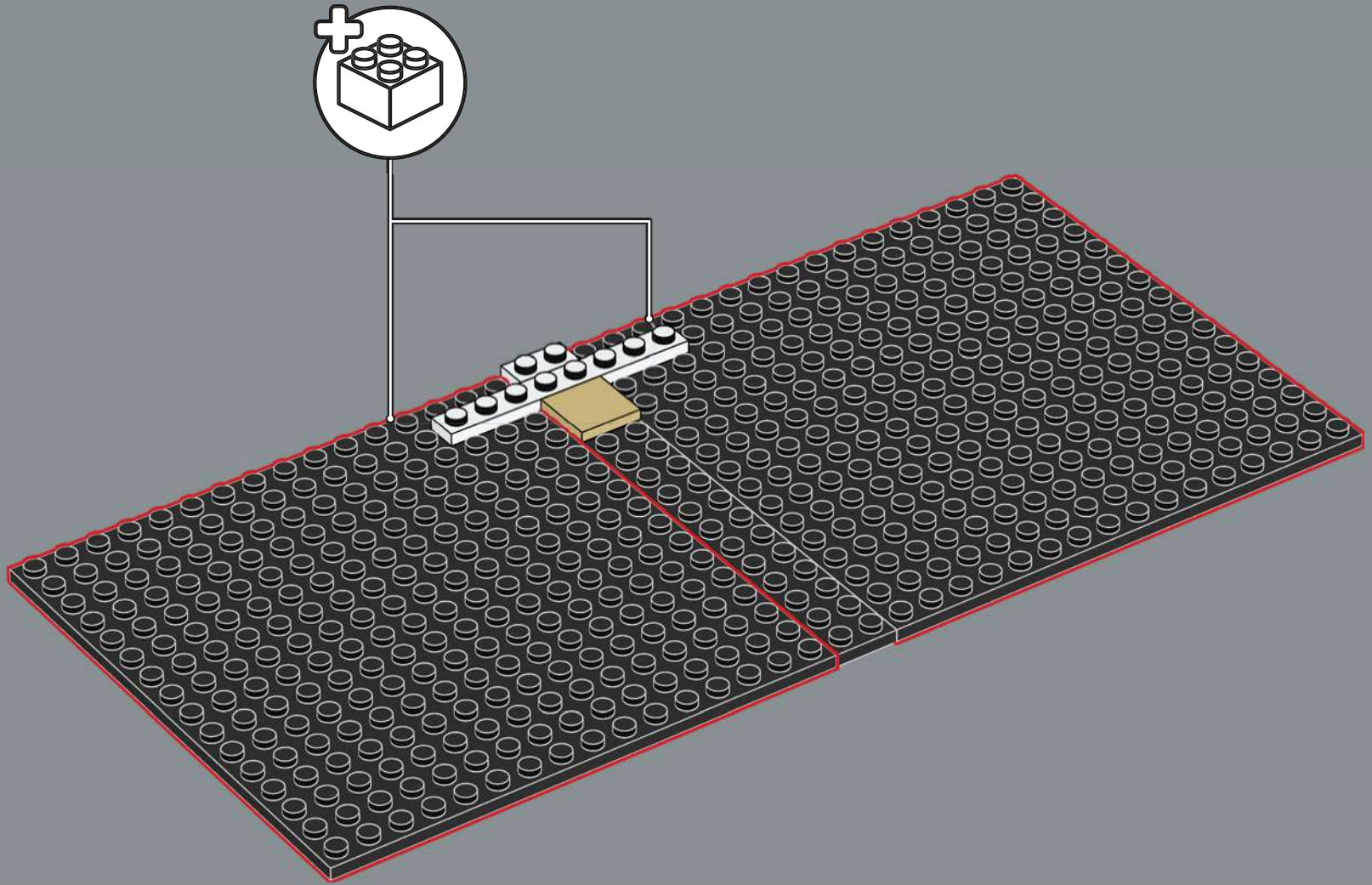

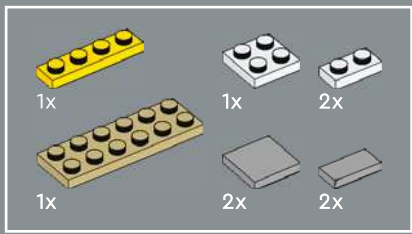

4

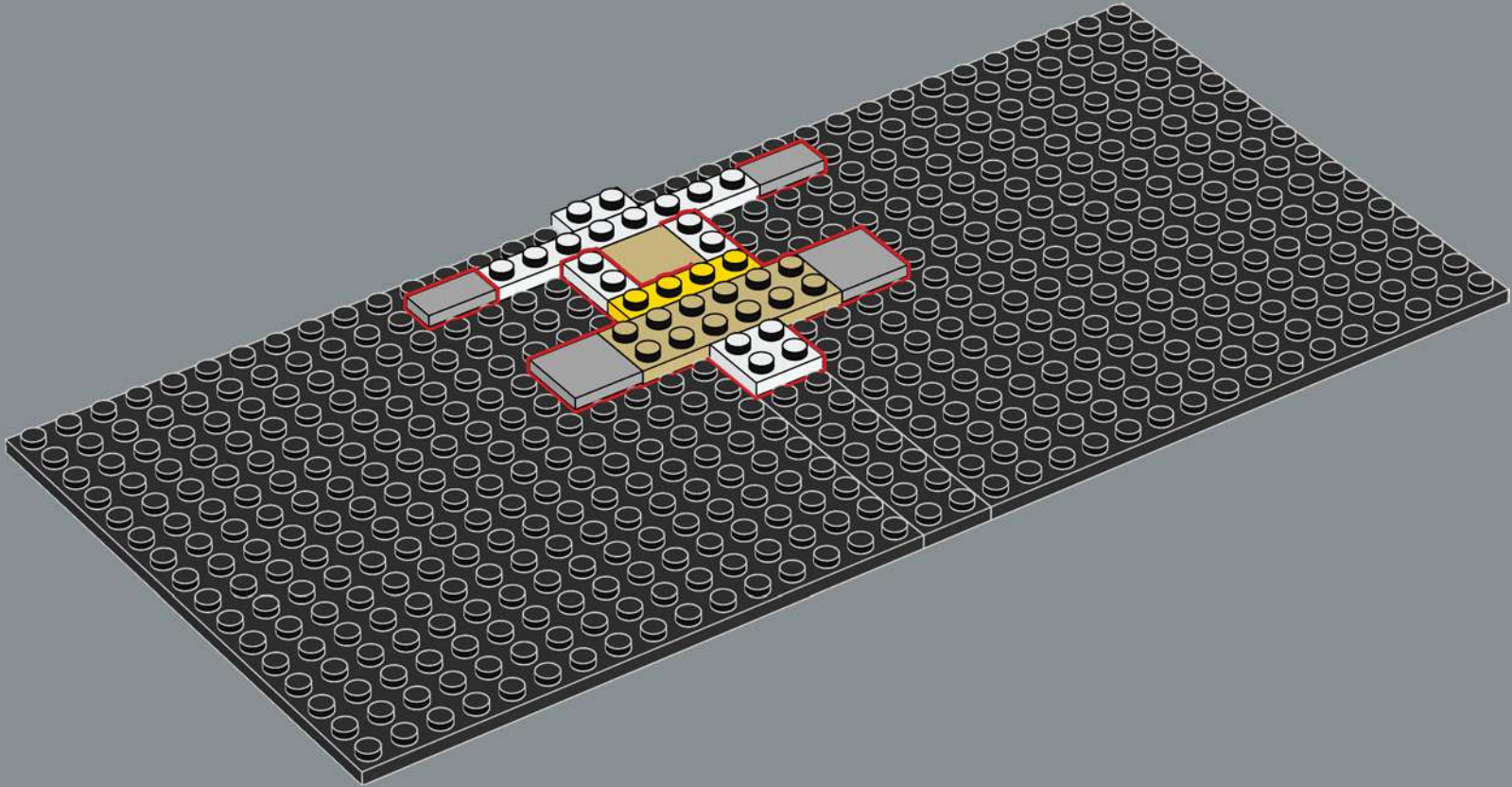

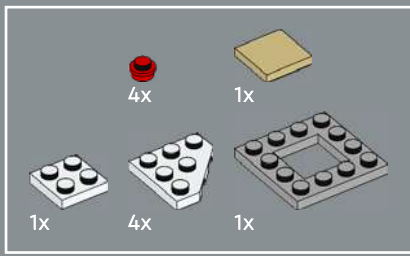

5

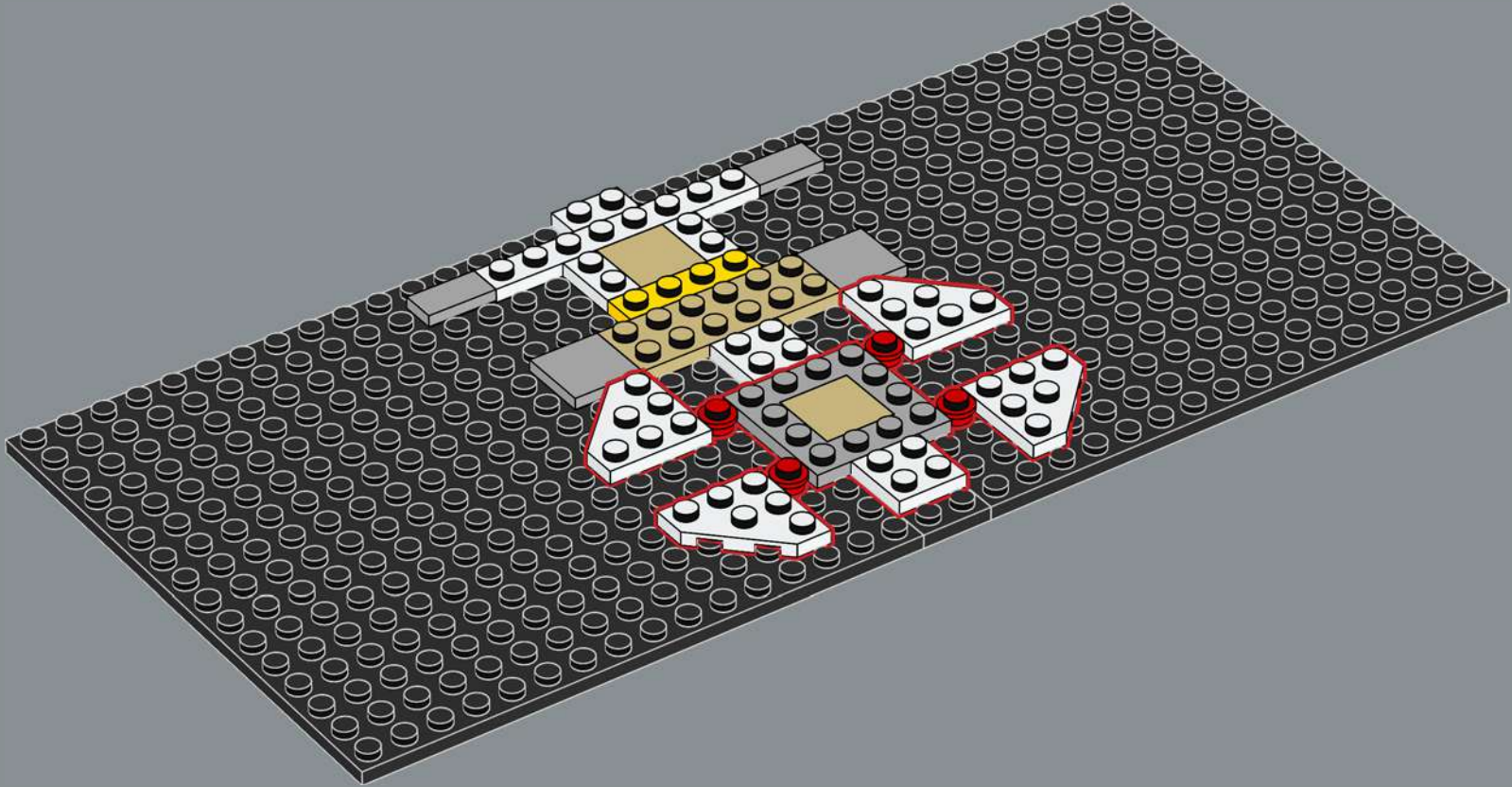



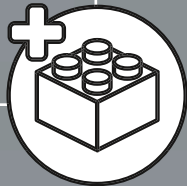
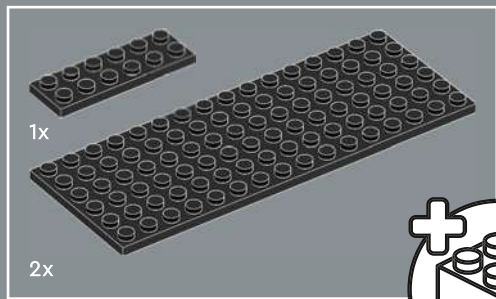

7

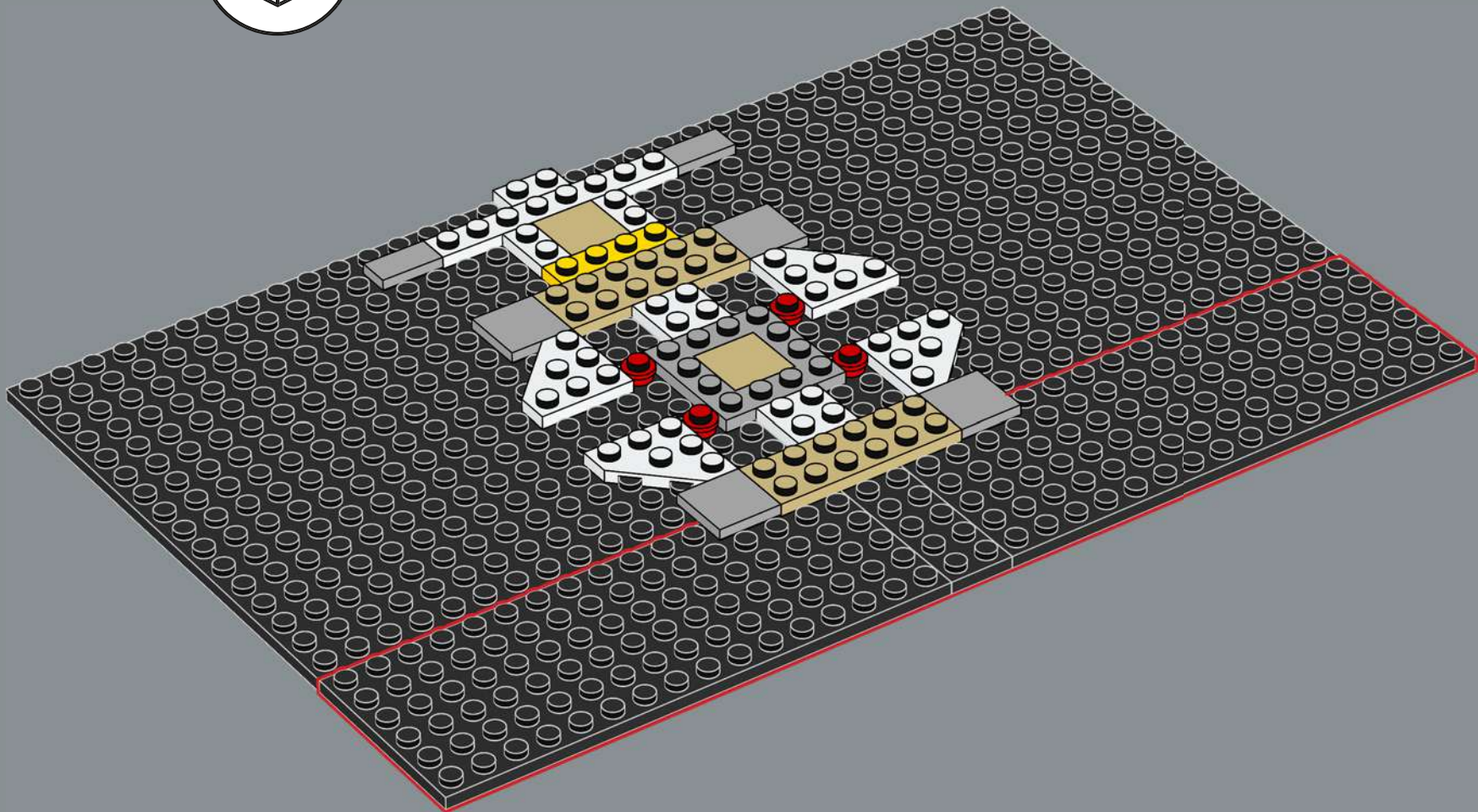

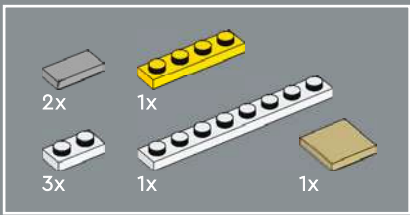

8

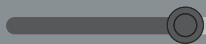
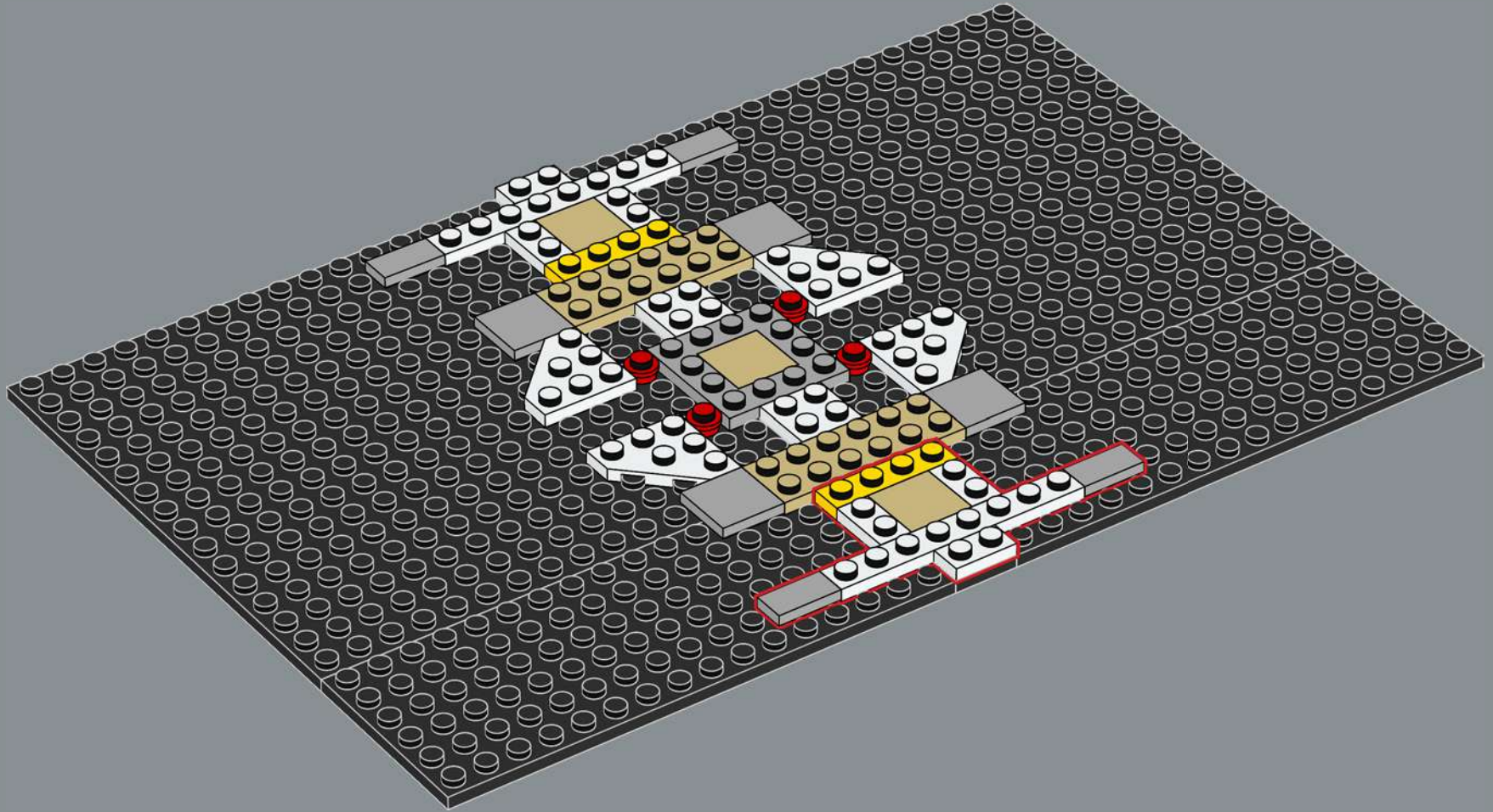



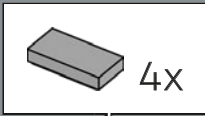
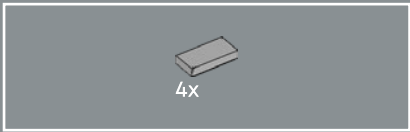

9

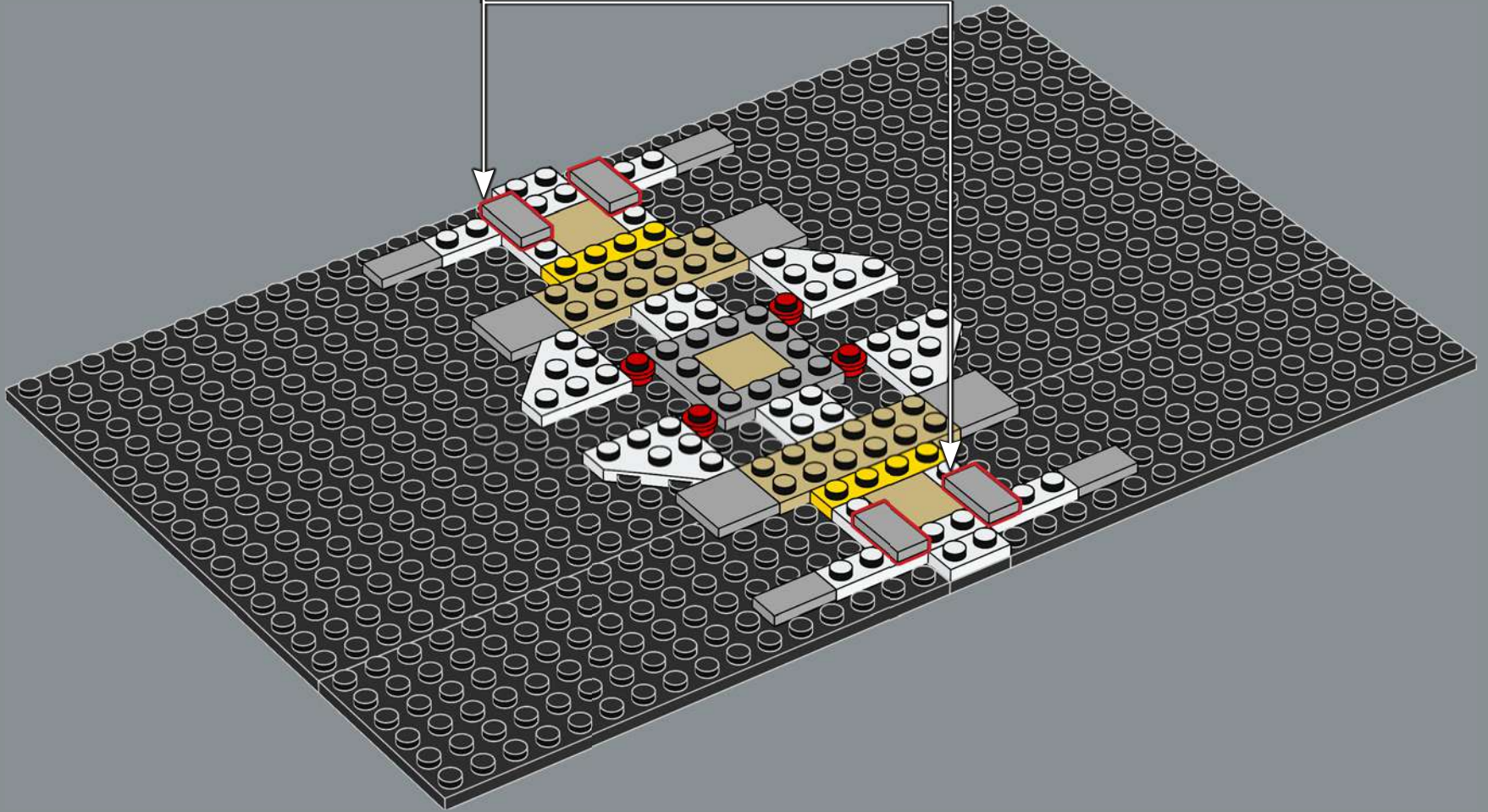

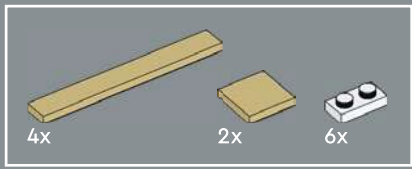

10

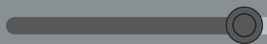
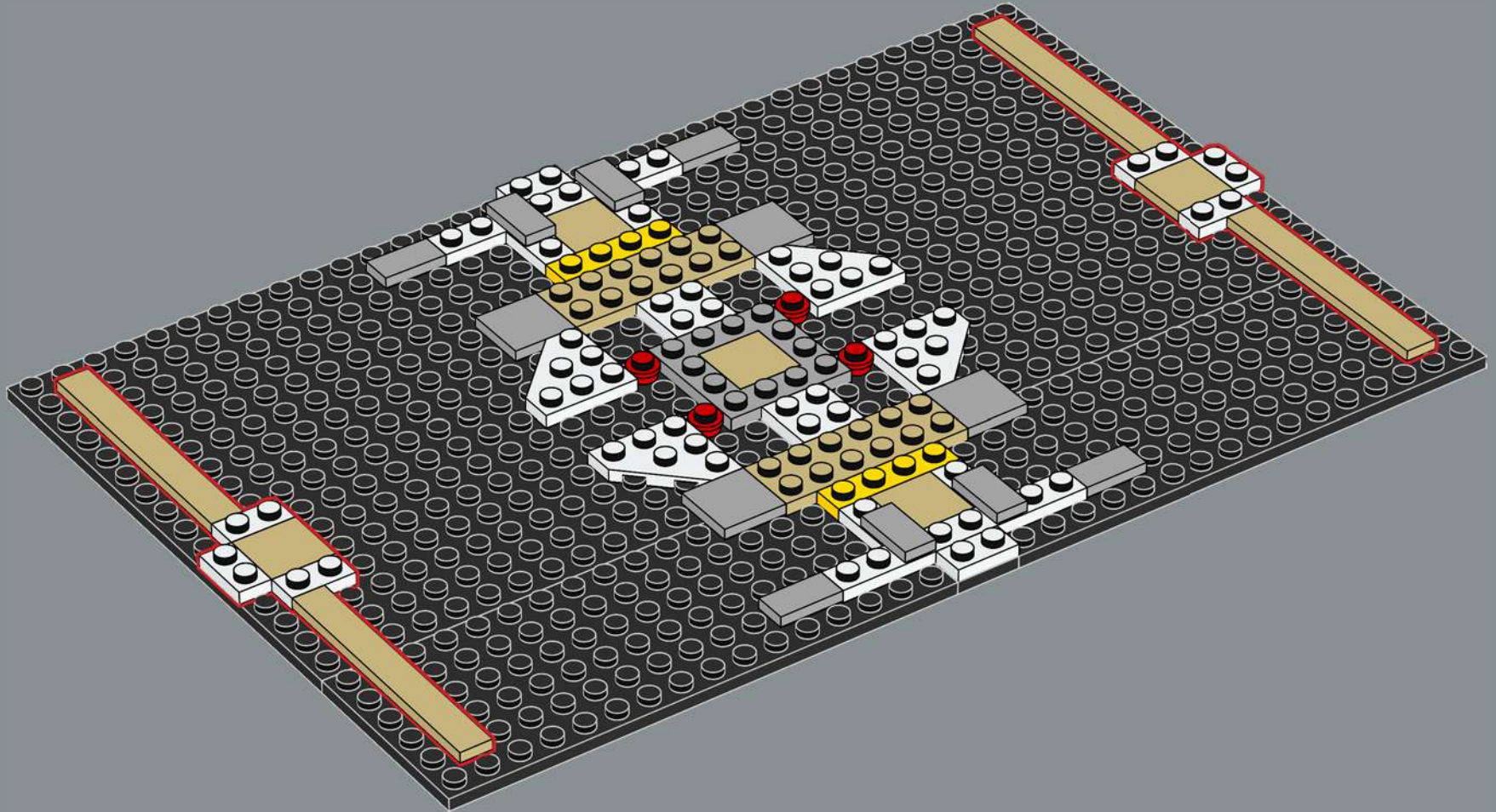

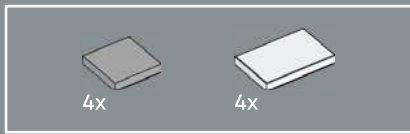

11

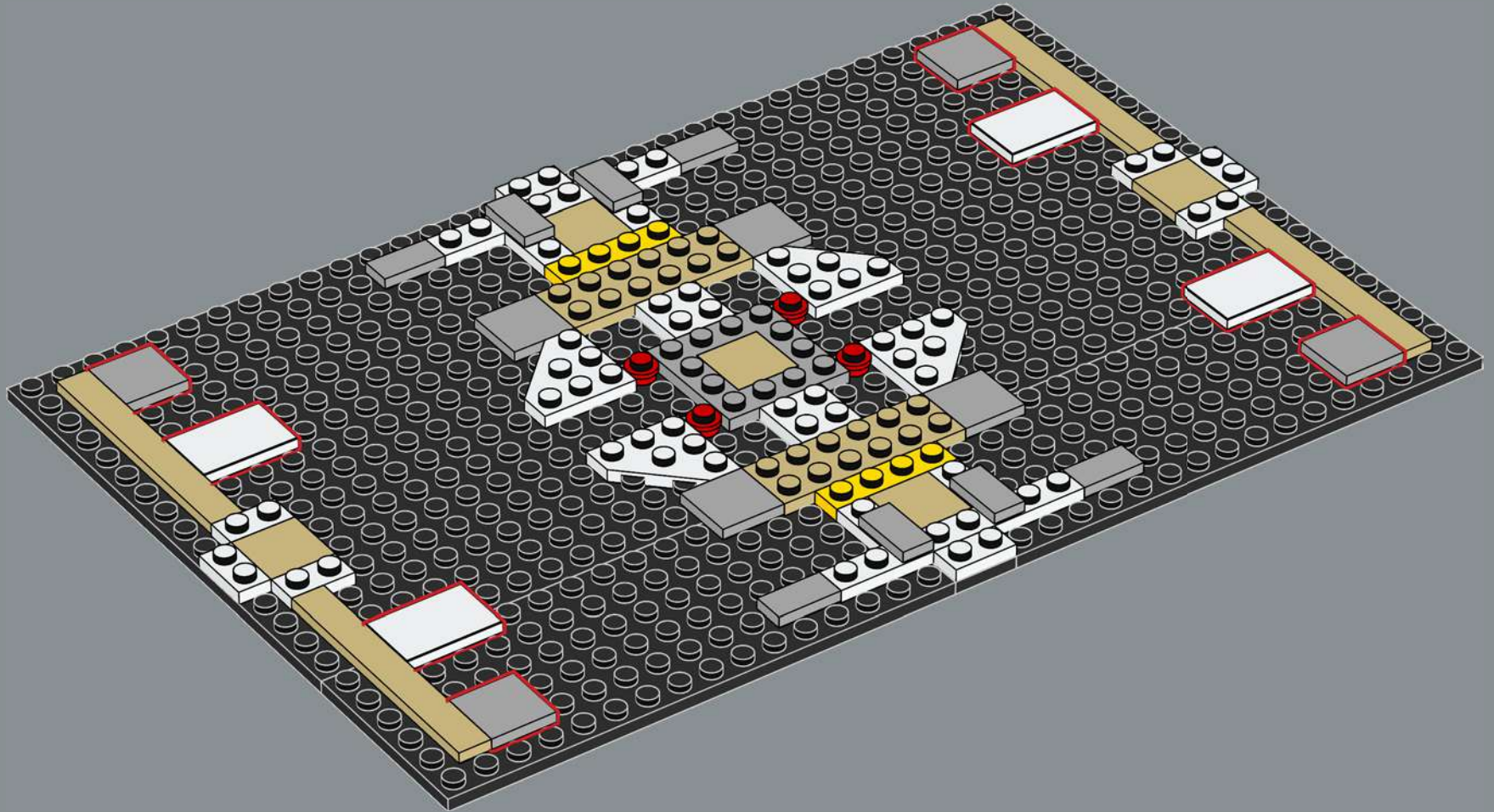



12

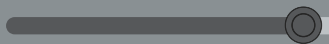
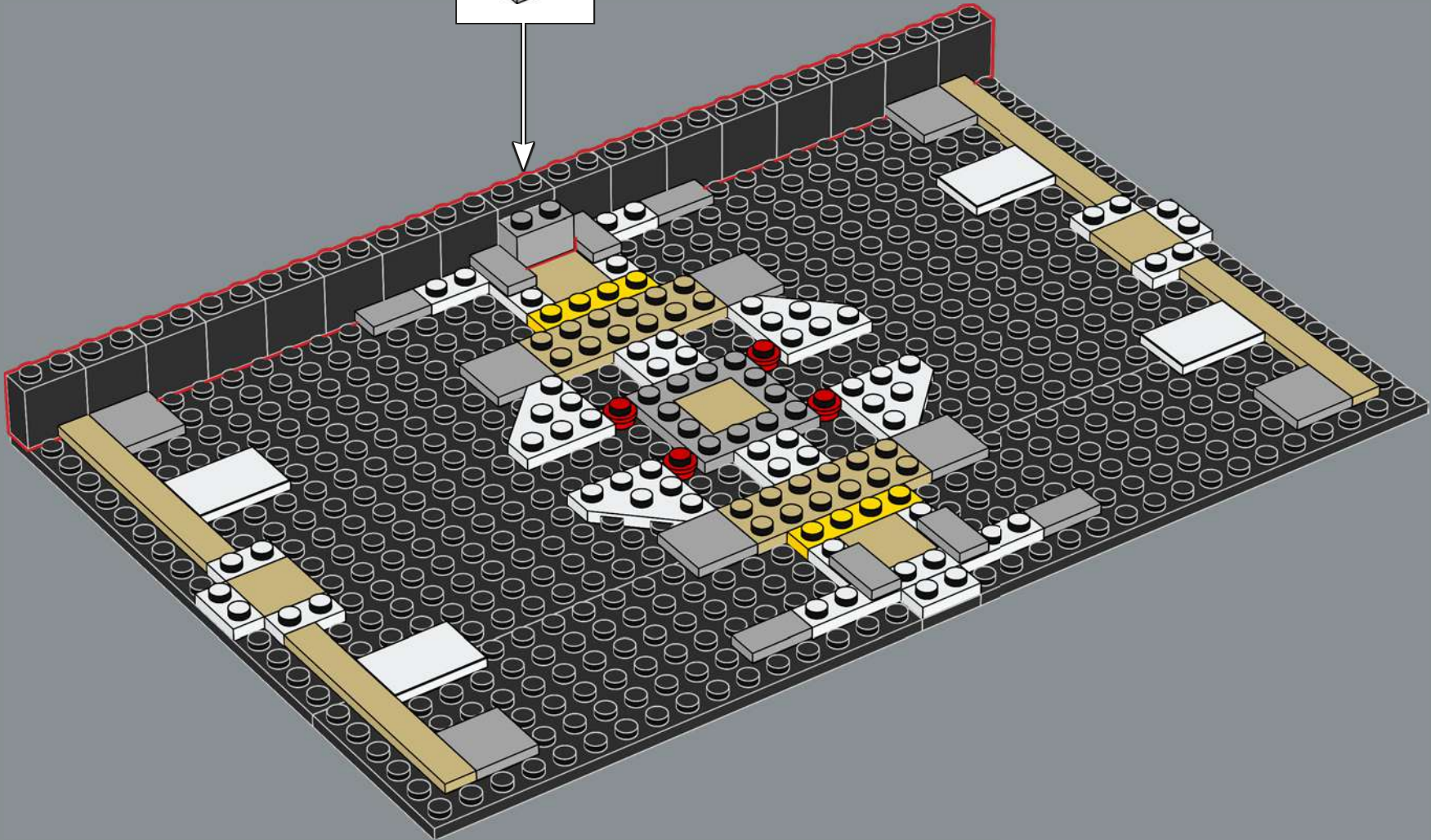
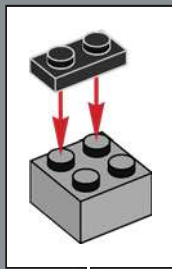



13

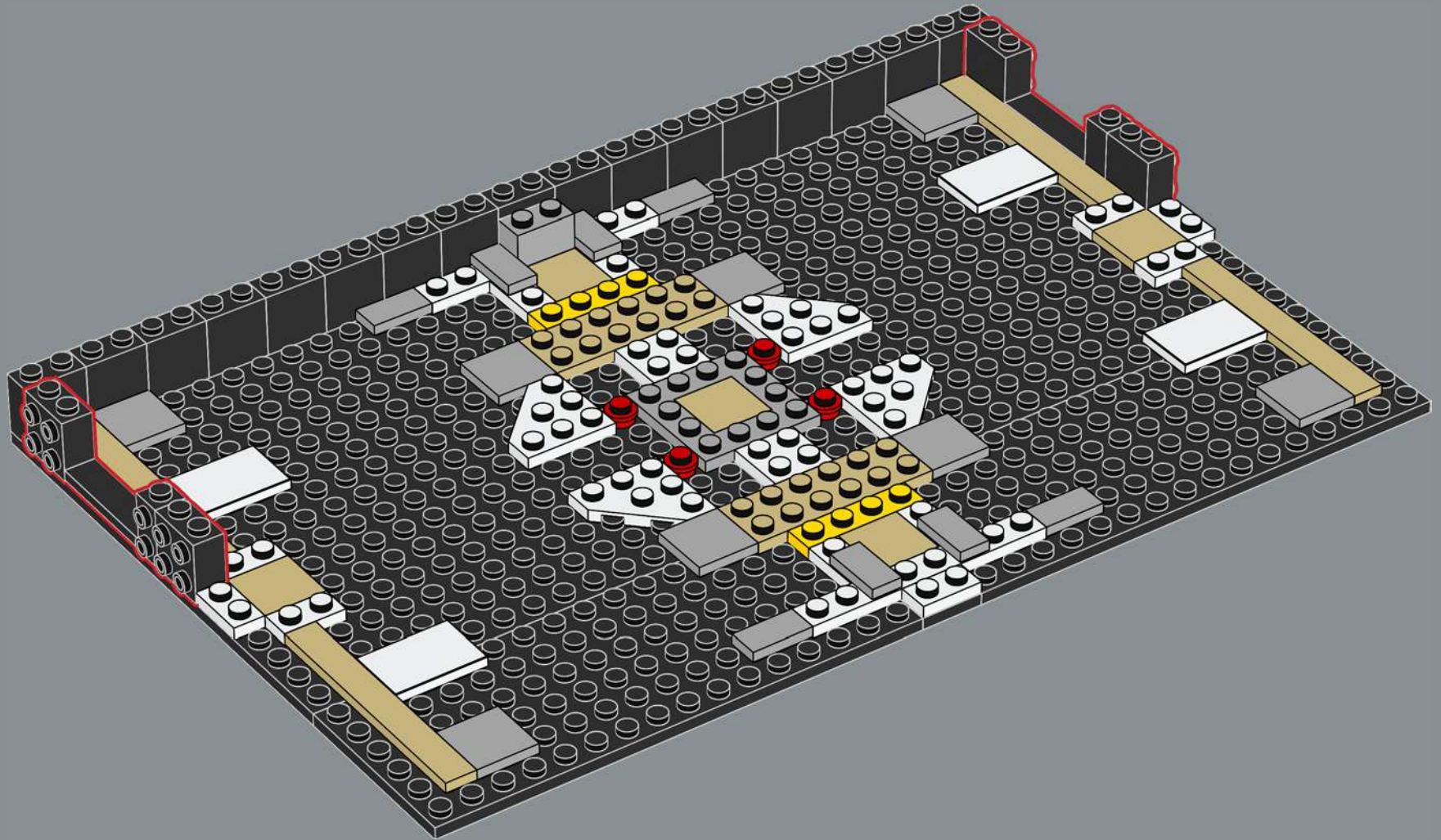

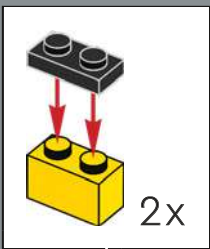
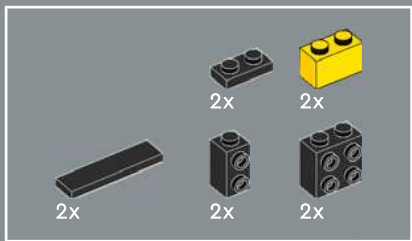

14

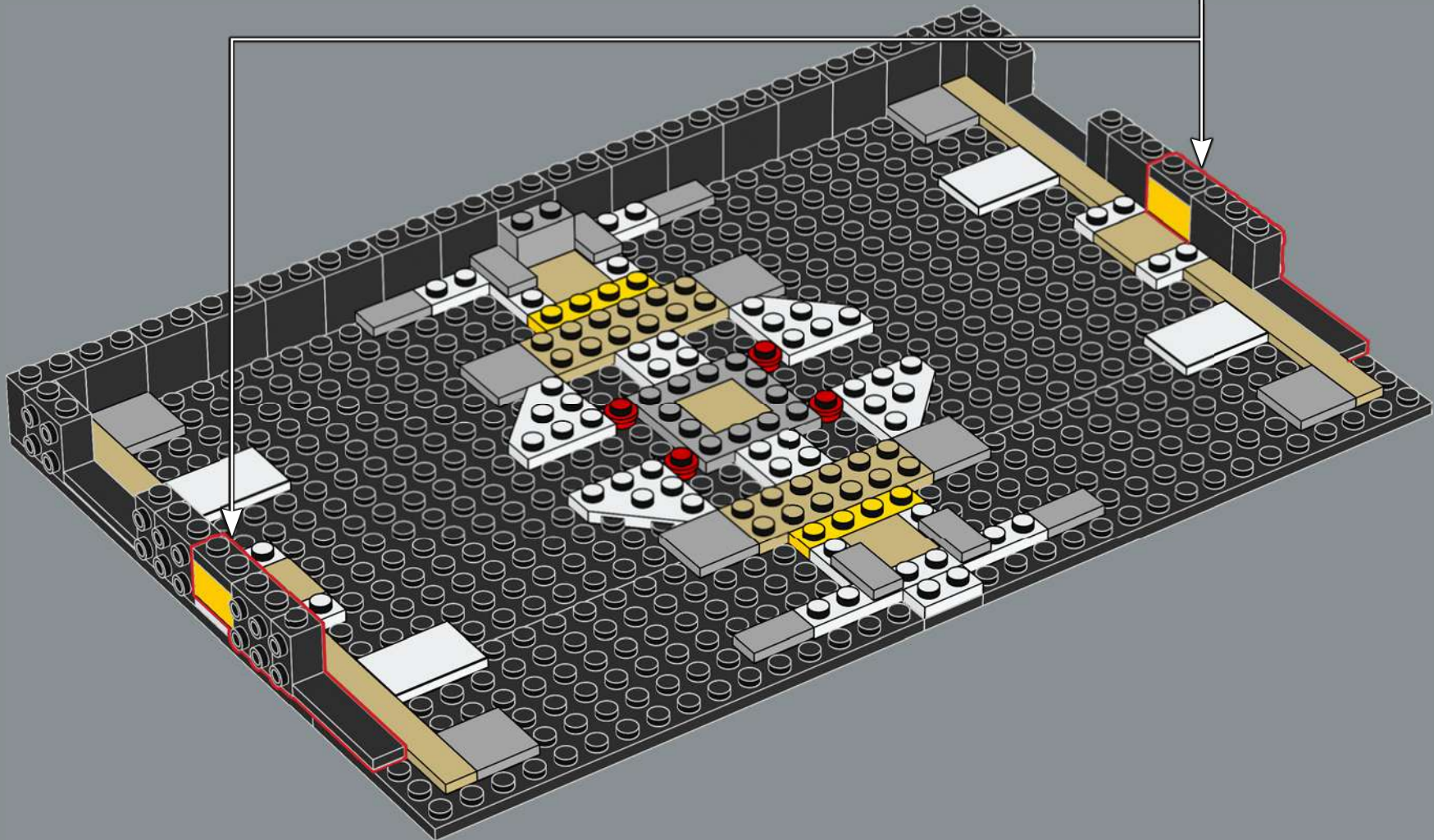

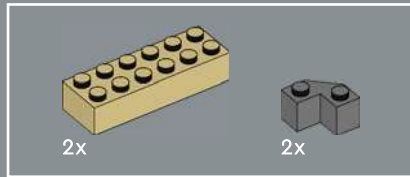

15

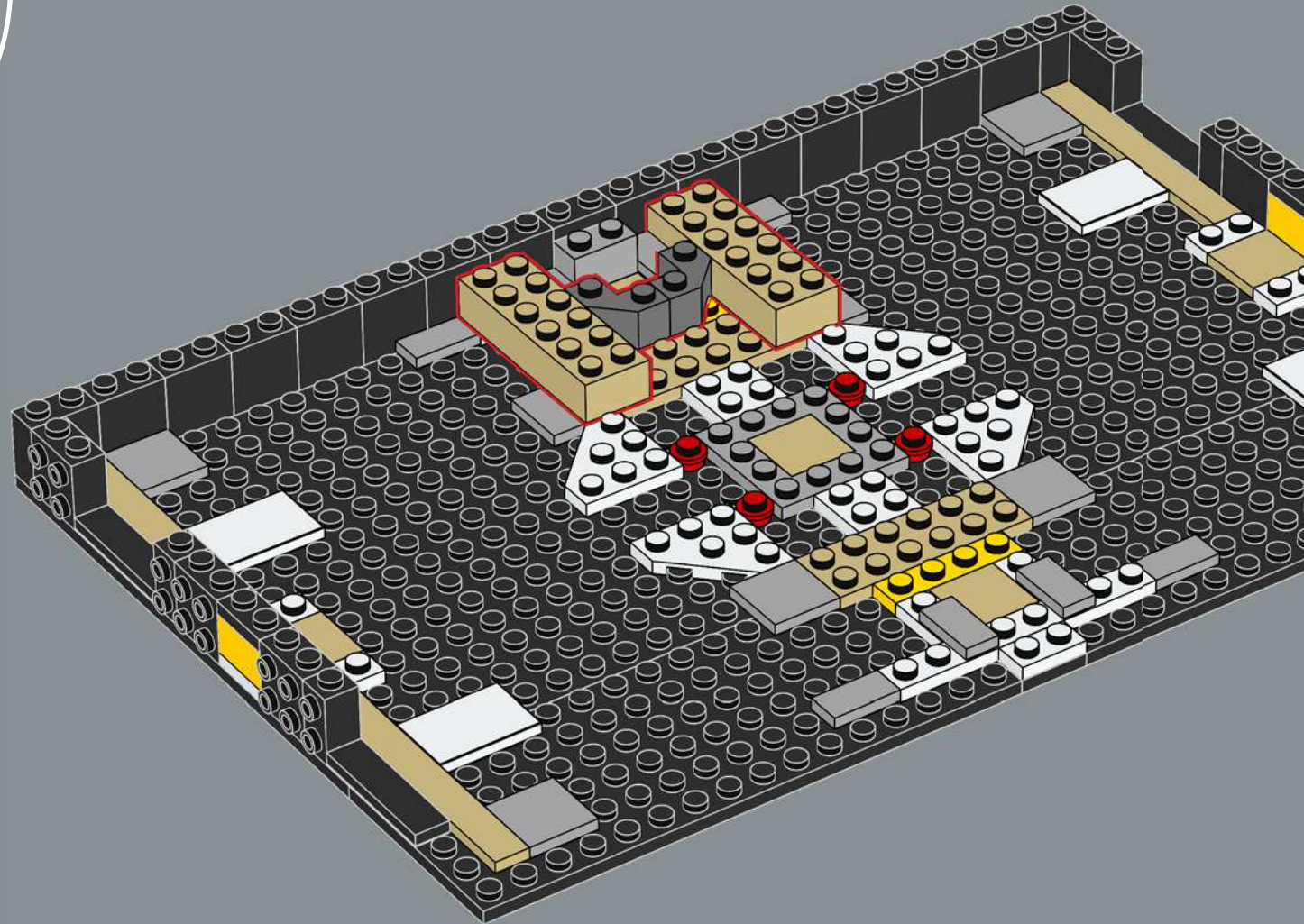

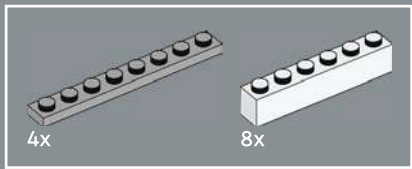

16

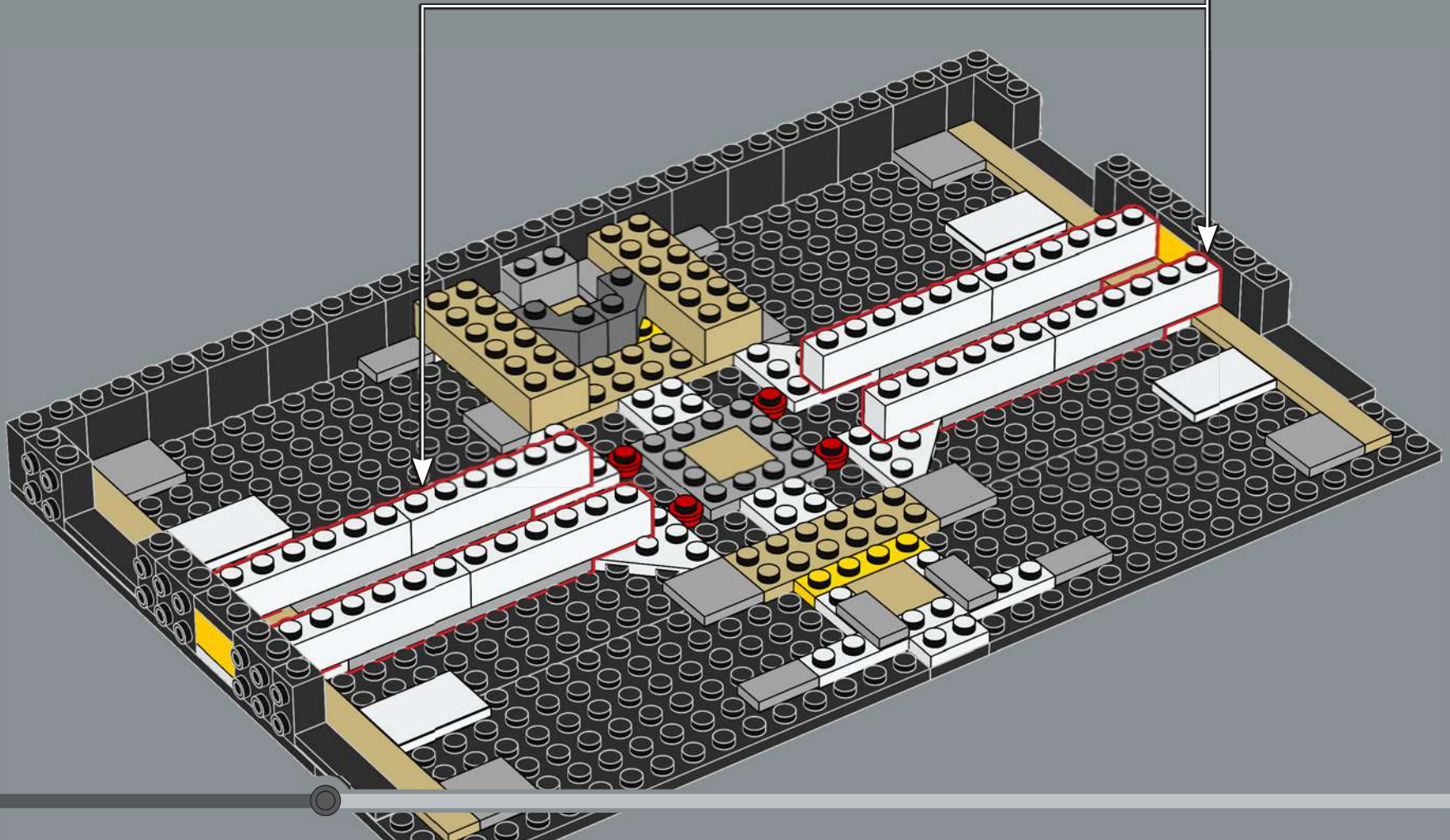
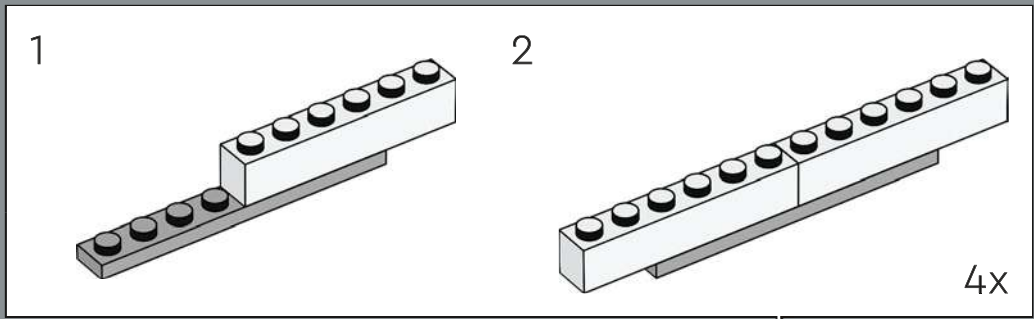



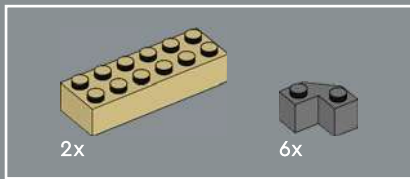

17

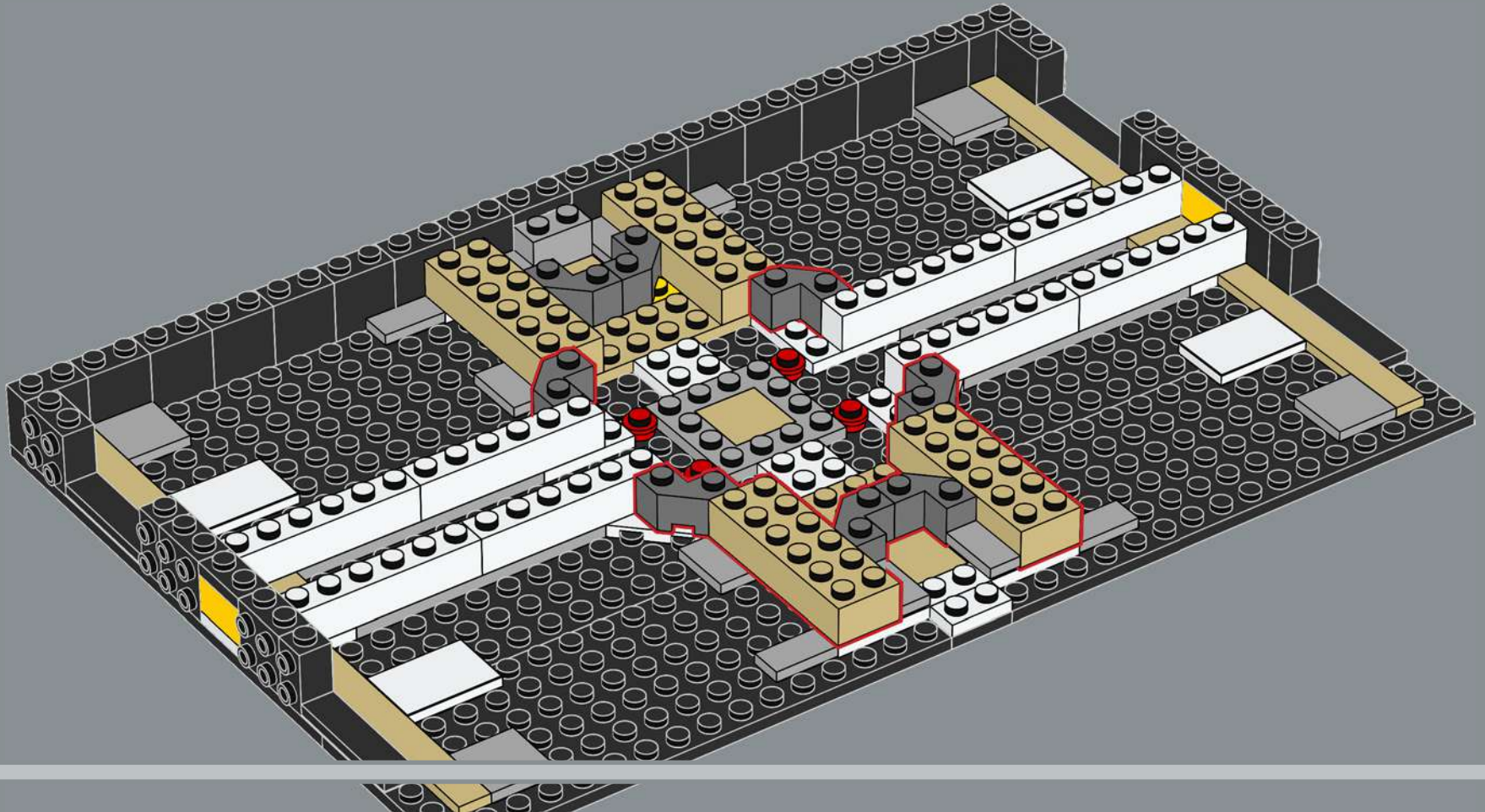

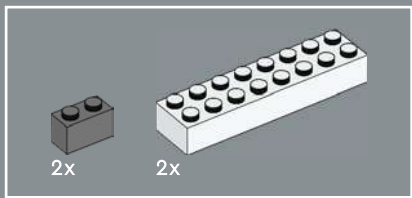

18

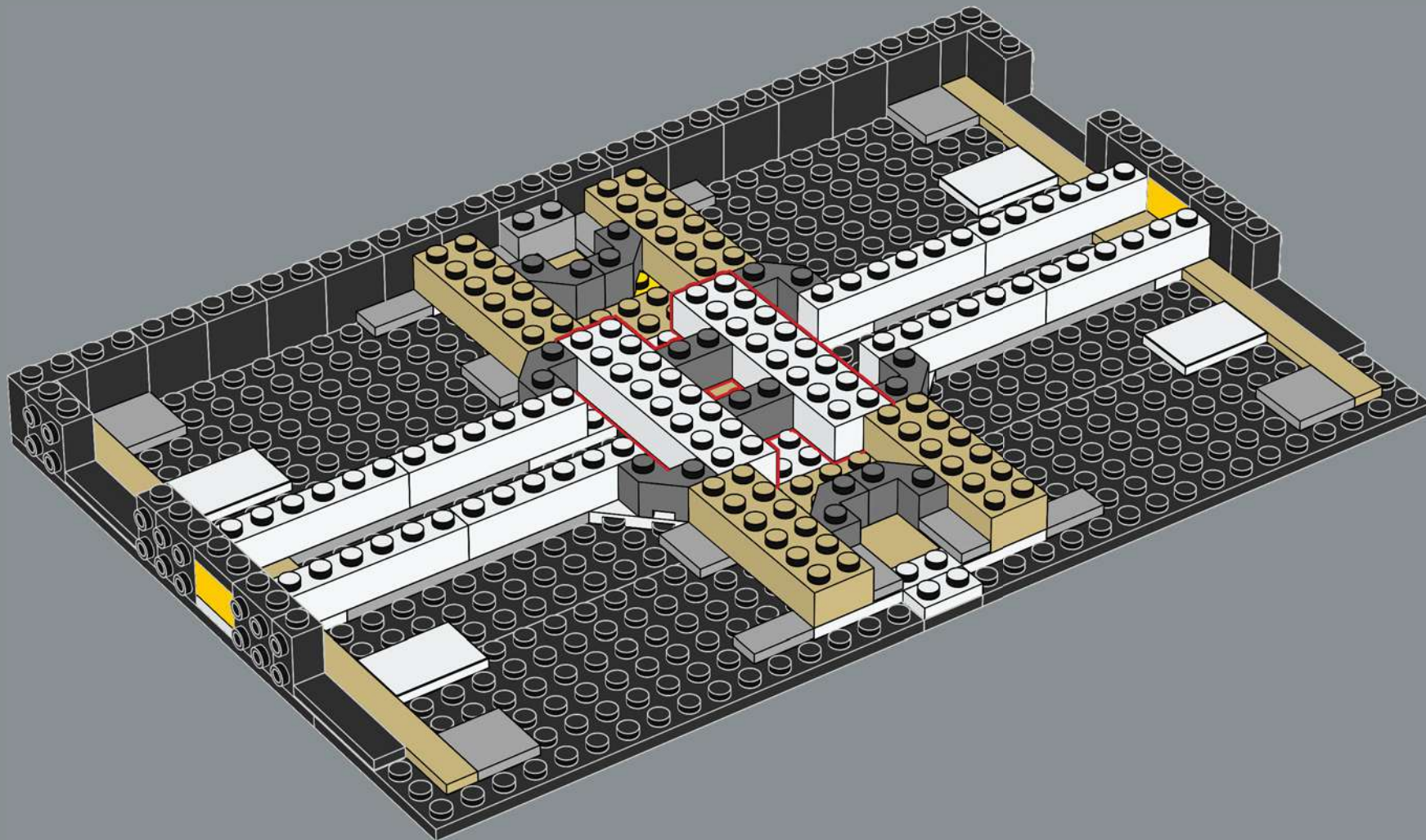

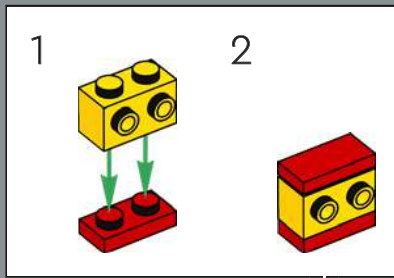

19

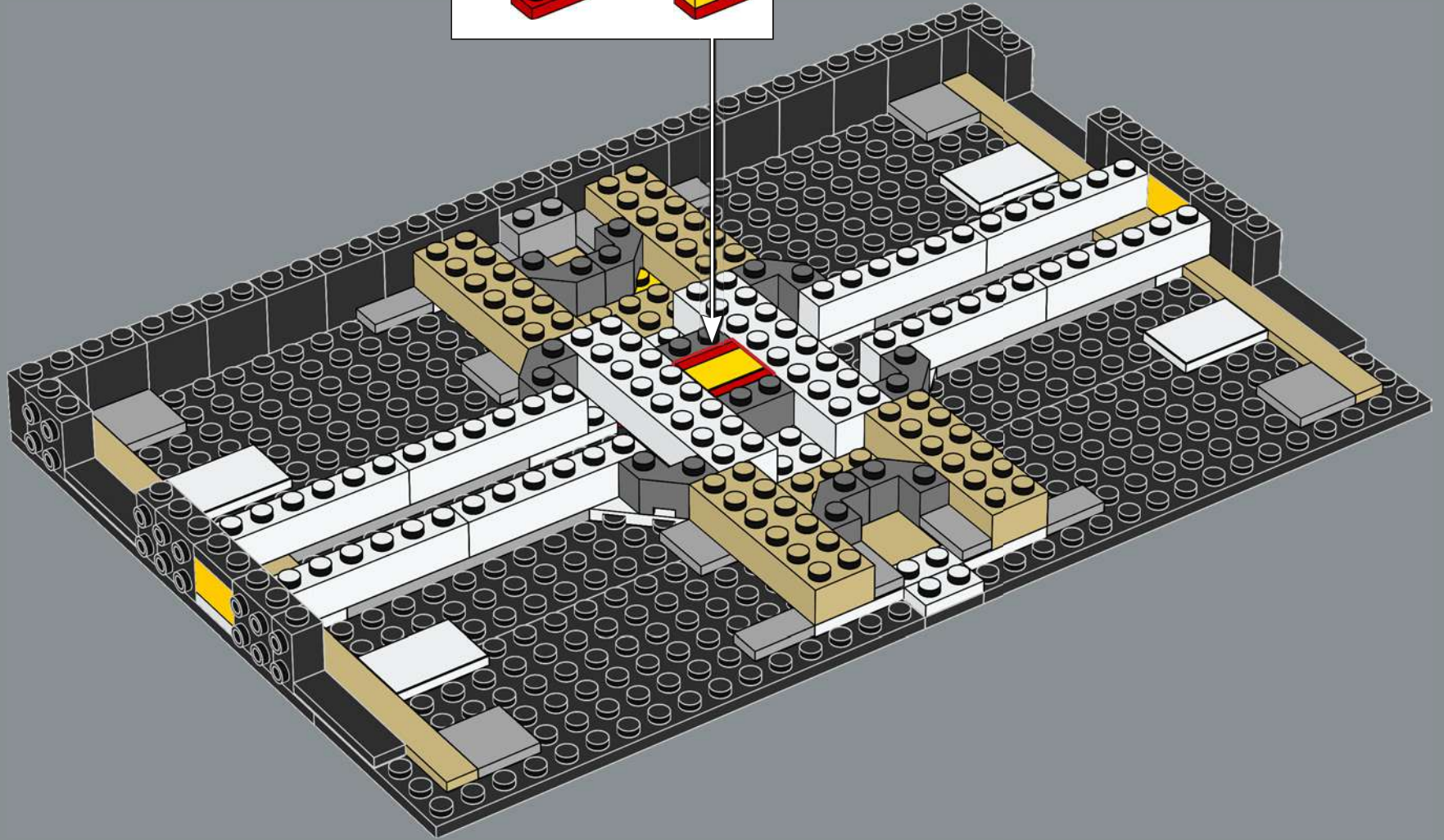



20

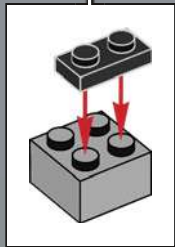
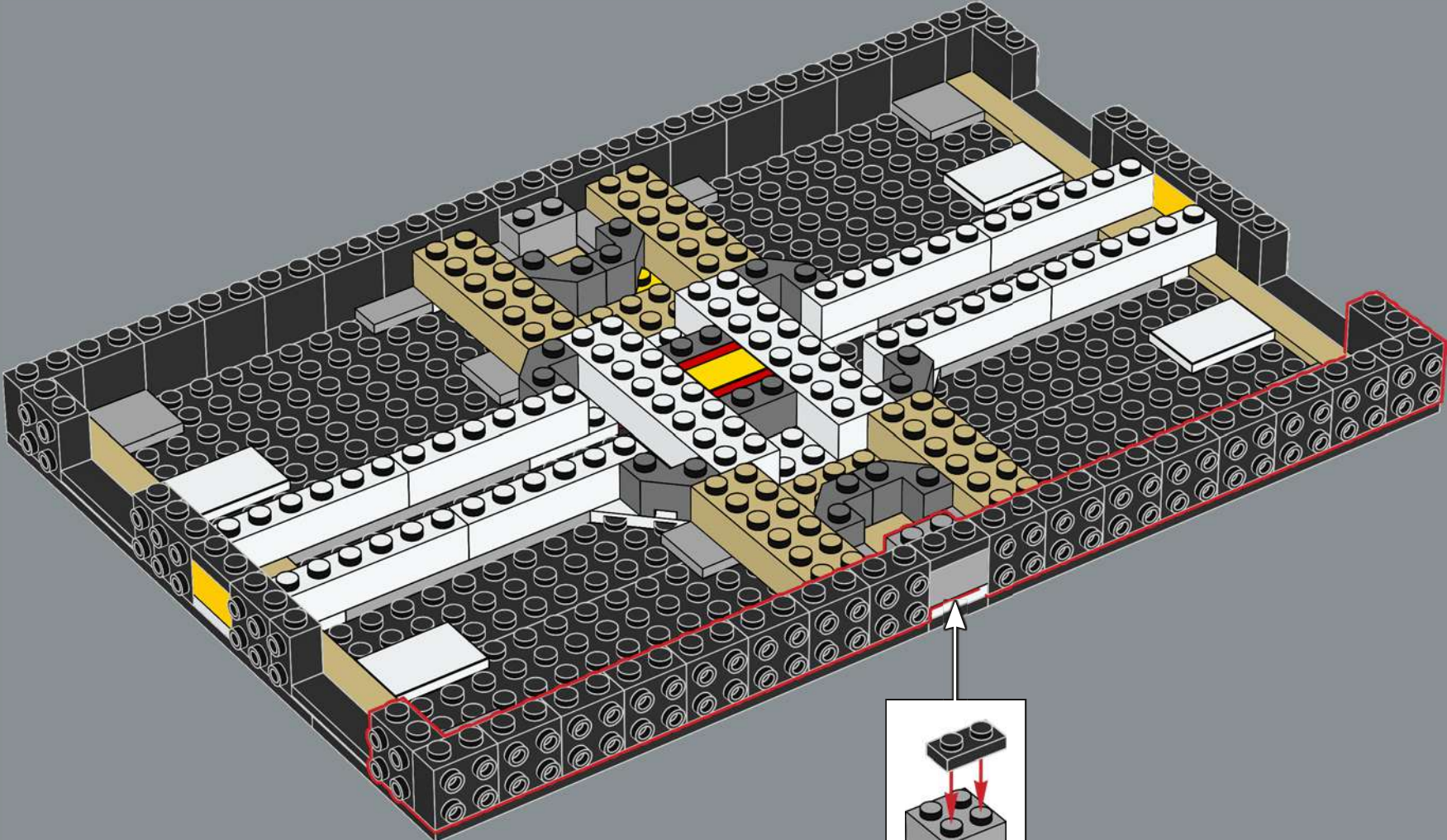

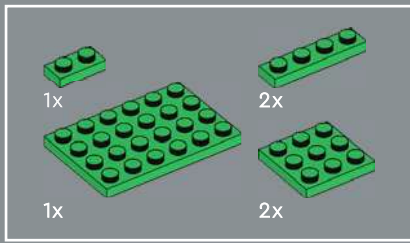

21

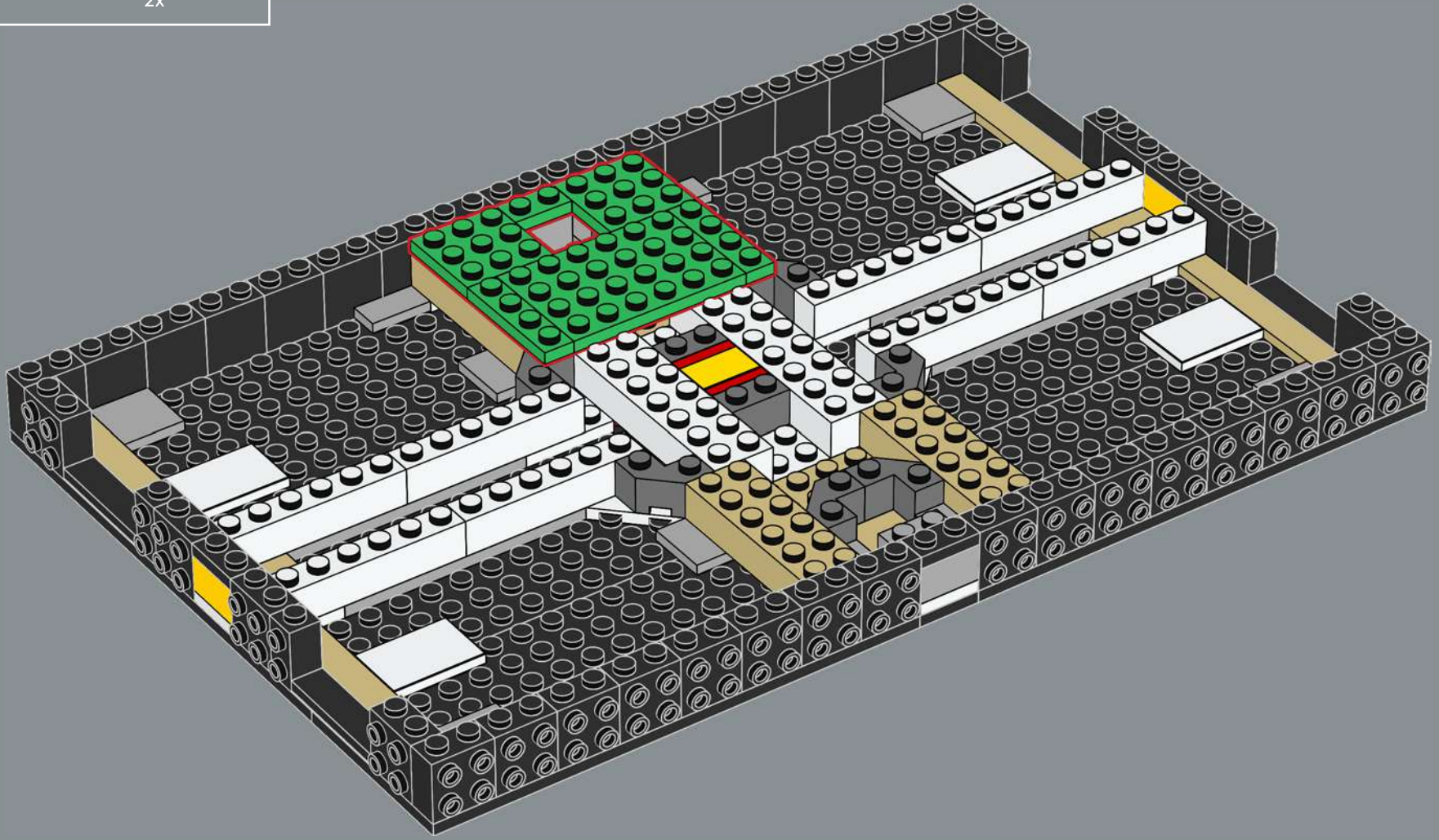

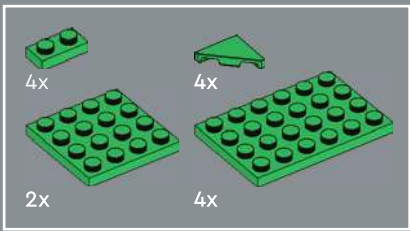

22

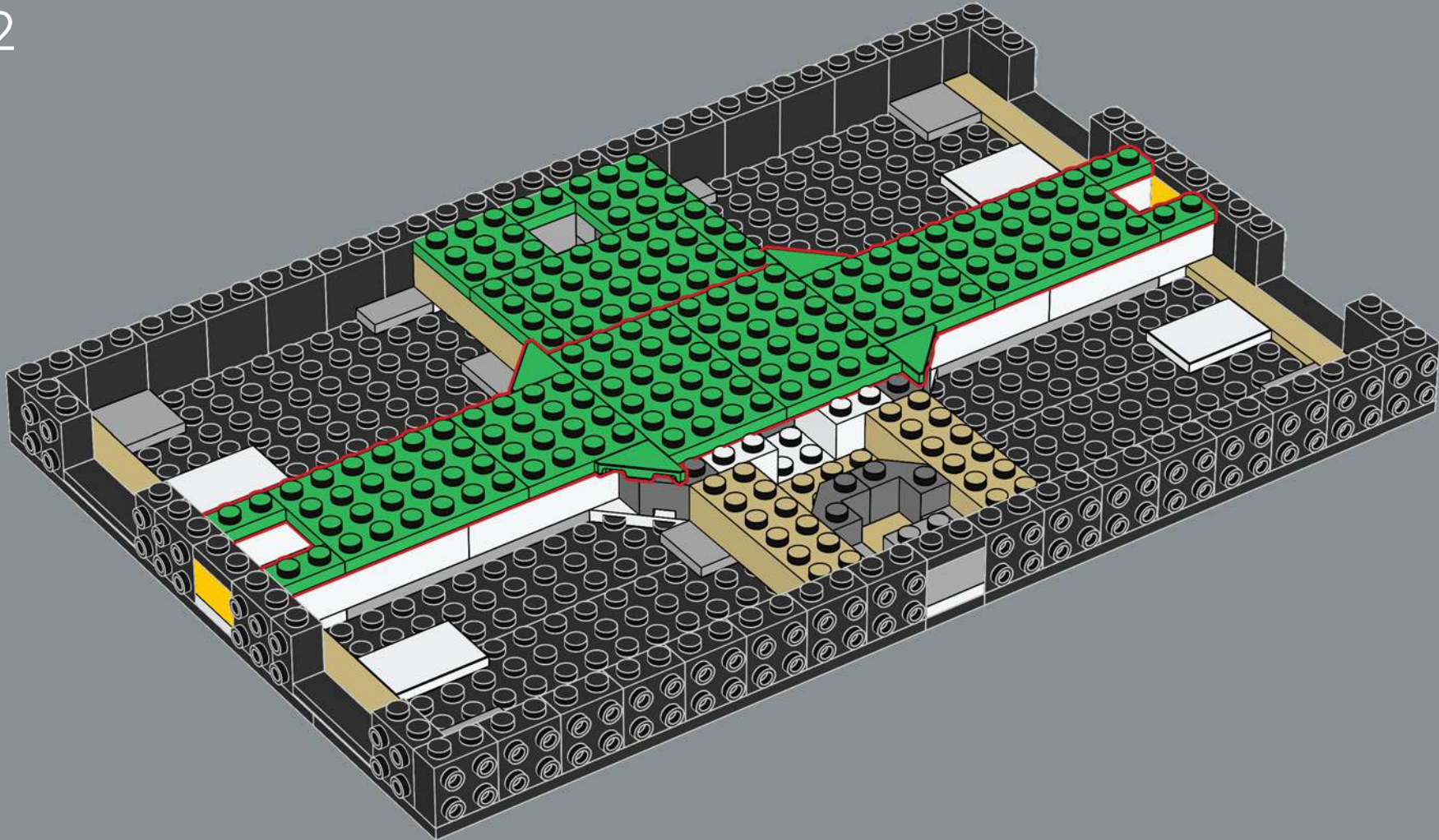

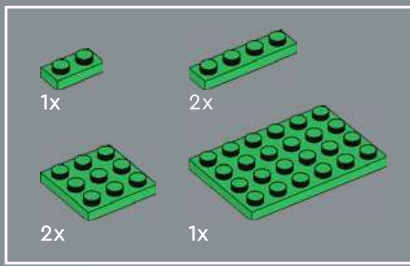

23

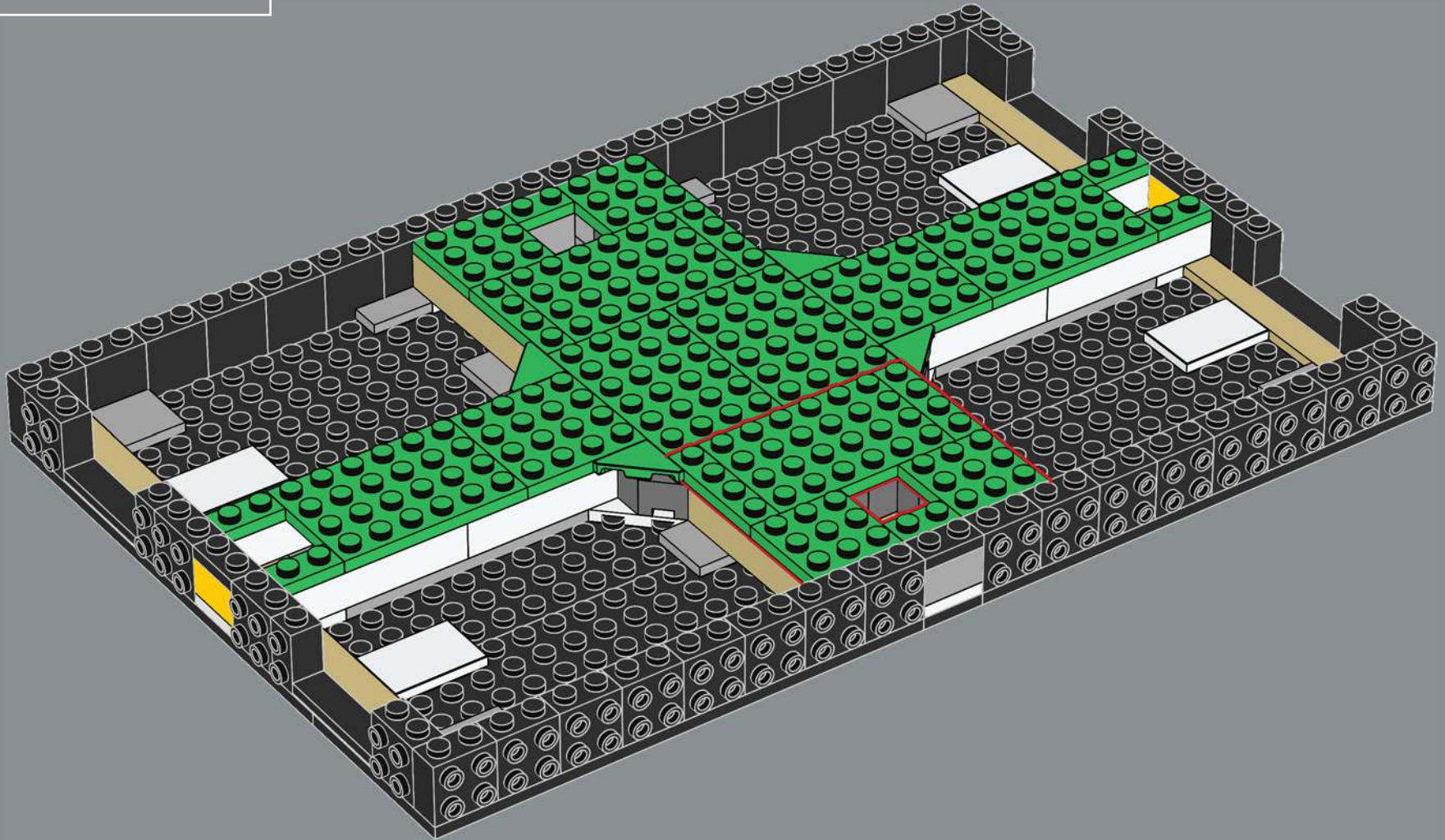





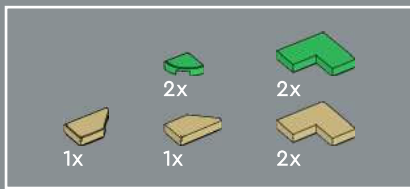

24

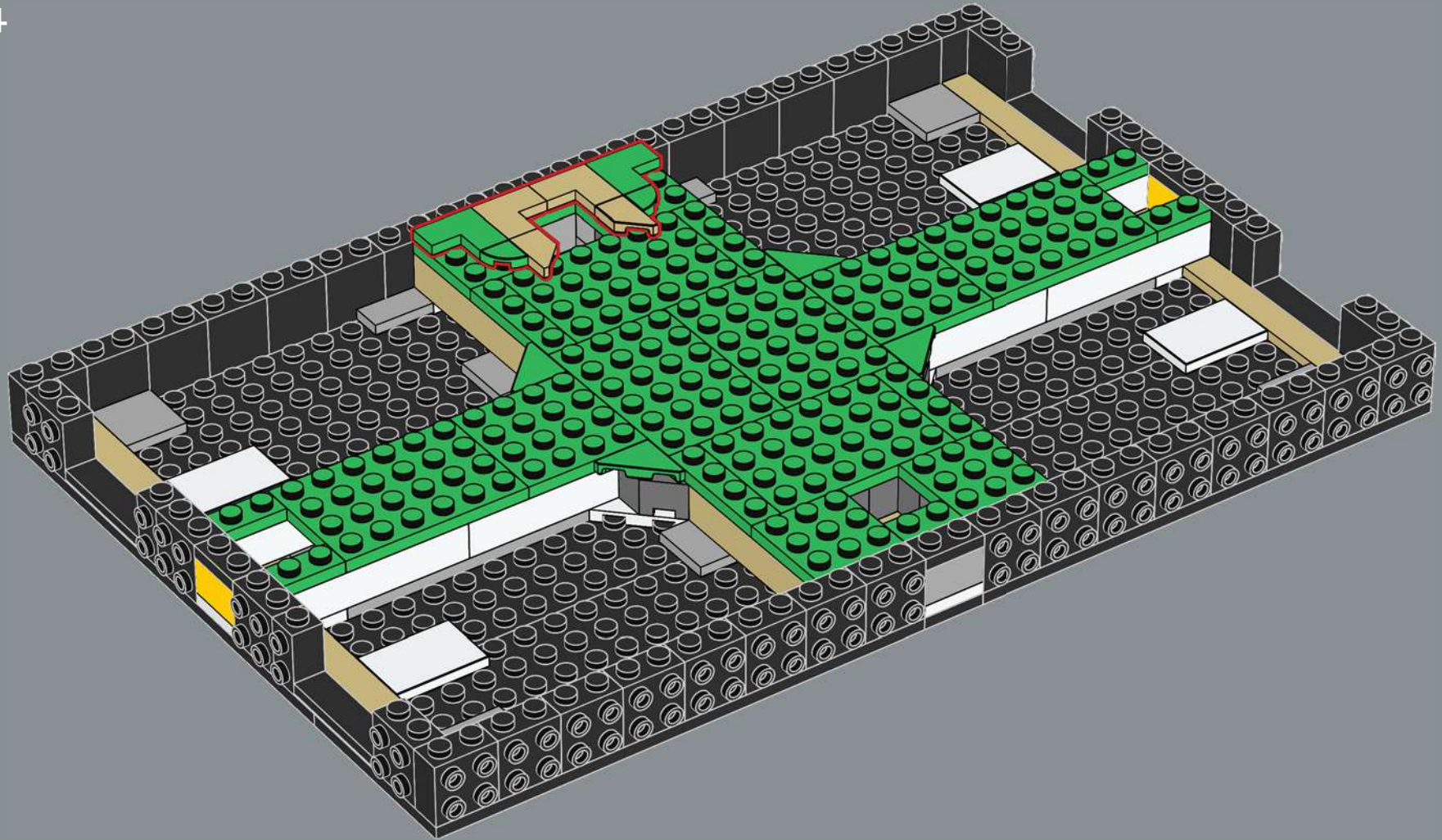



25

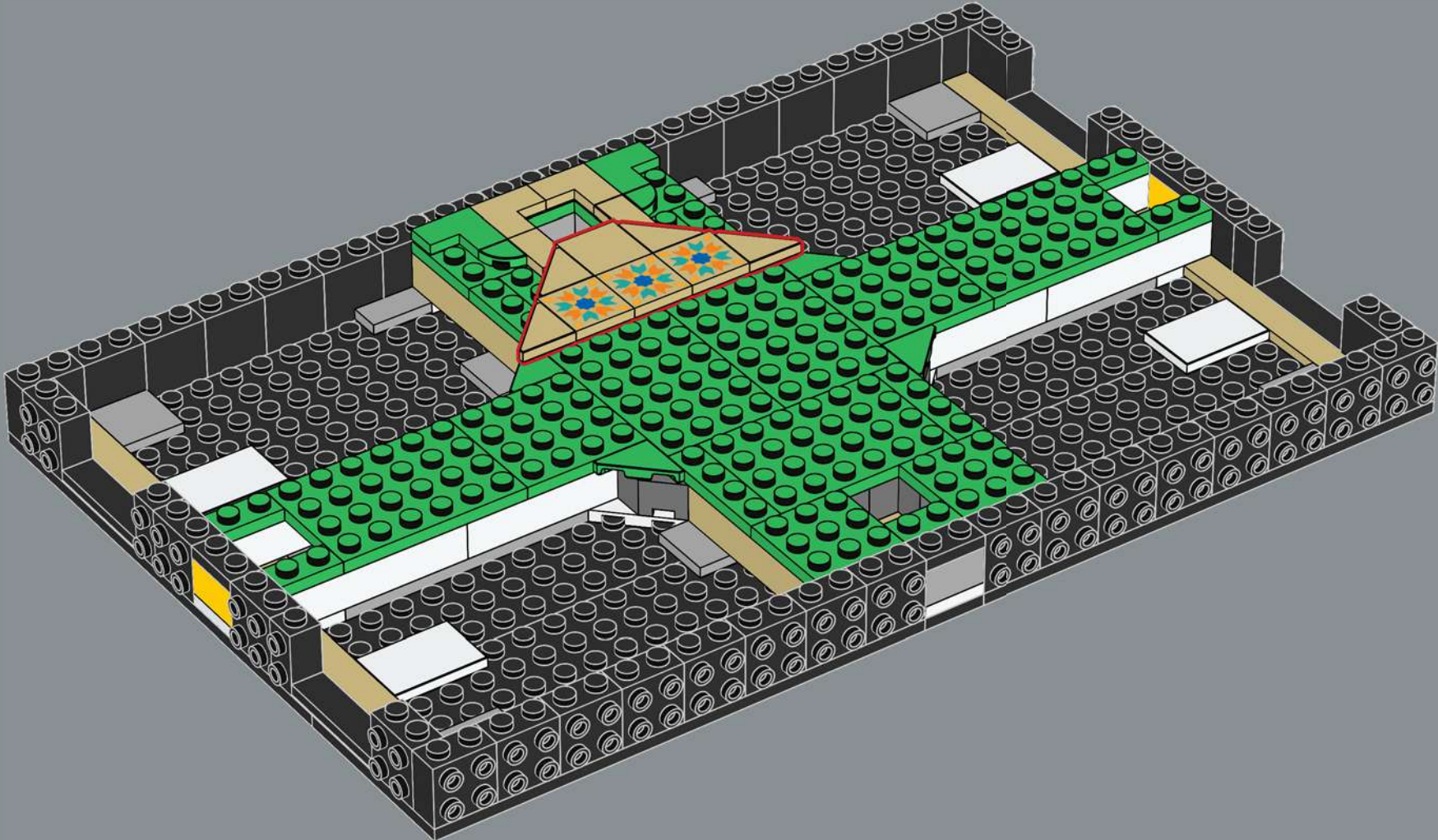

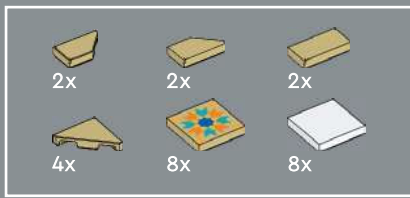

26

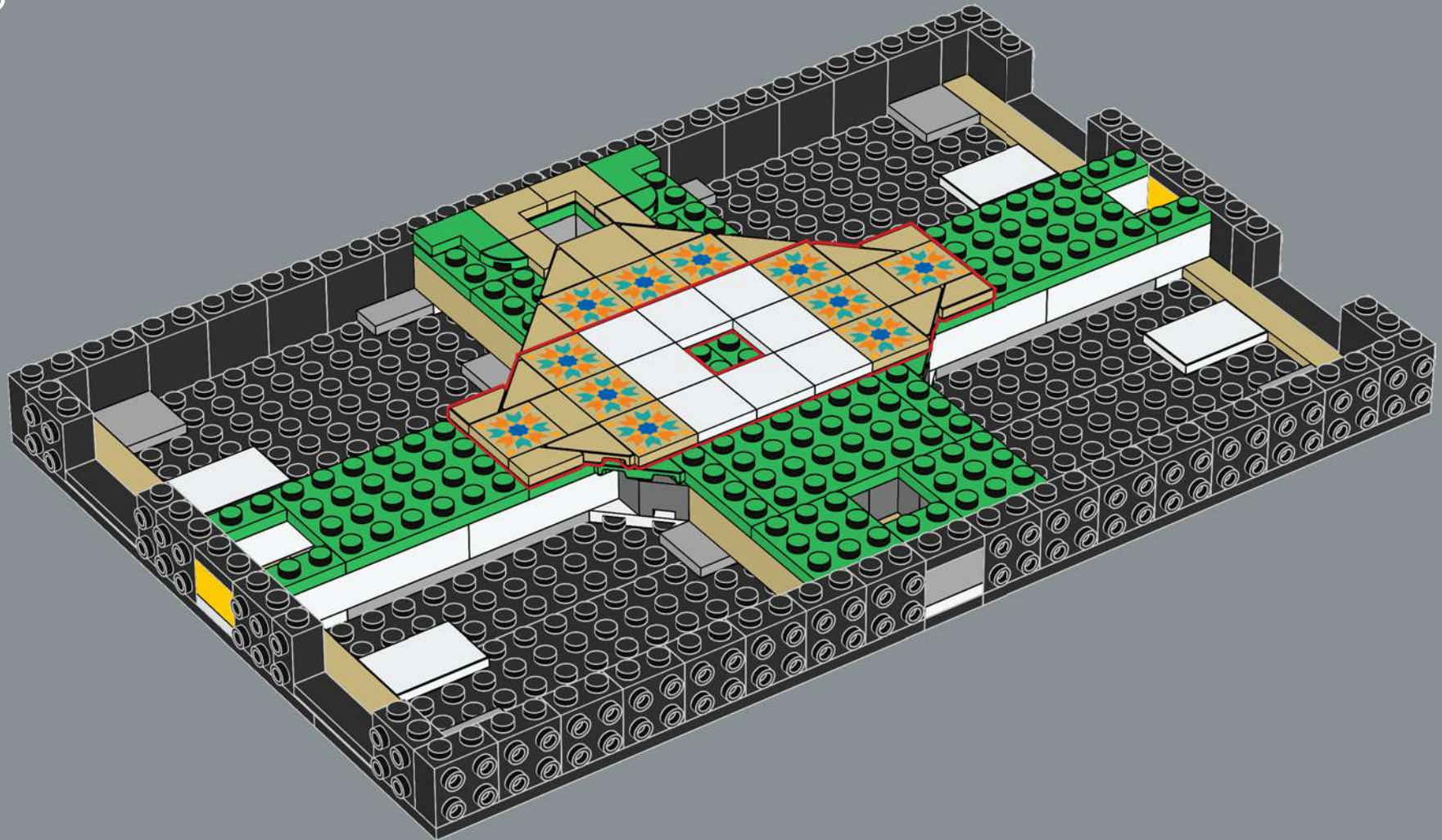



27

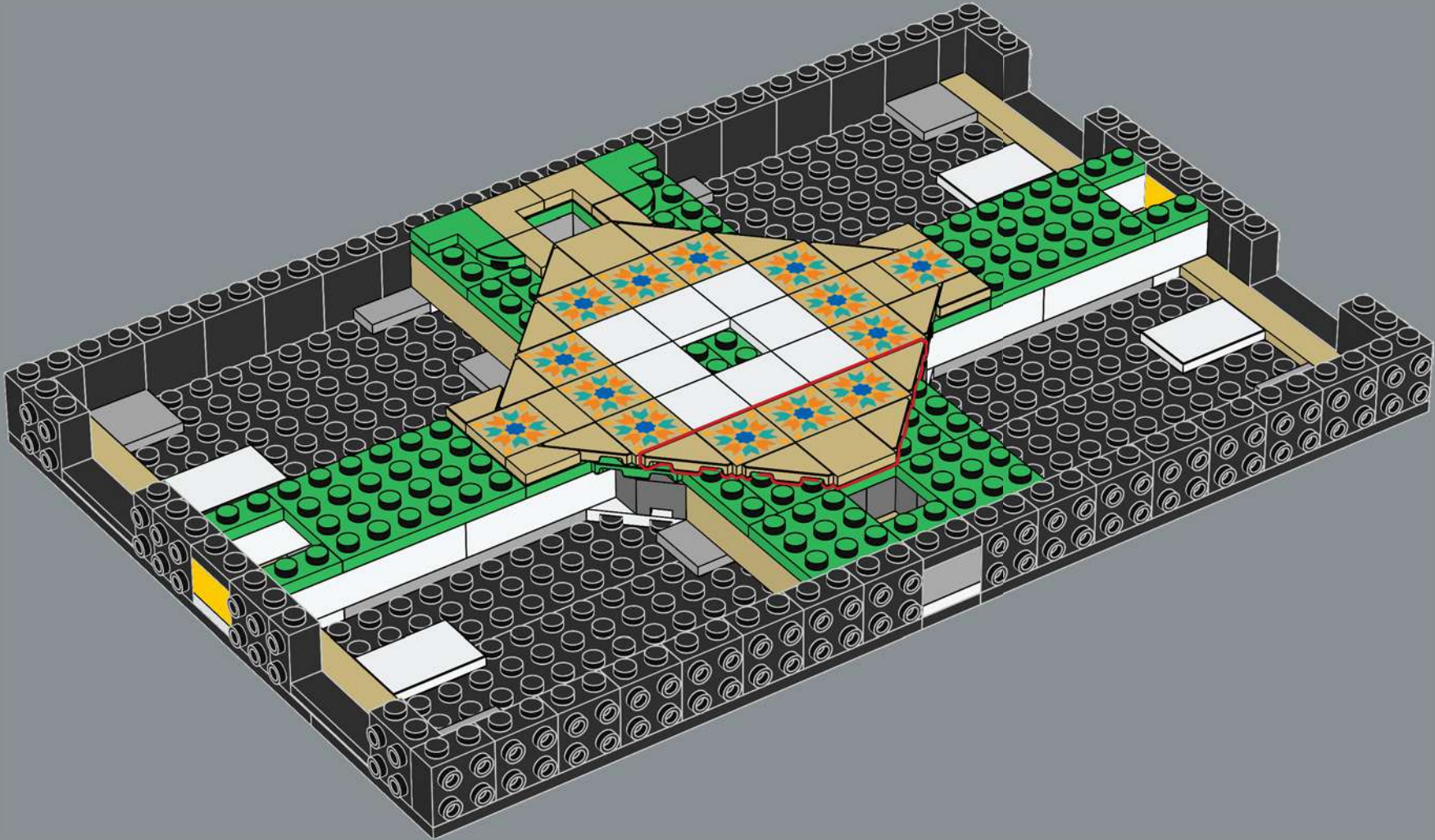

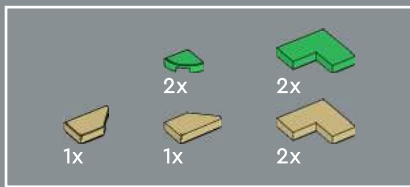

28

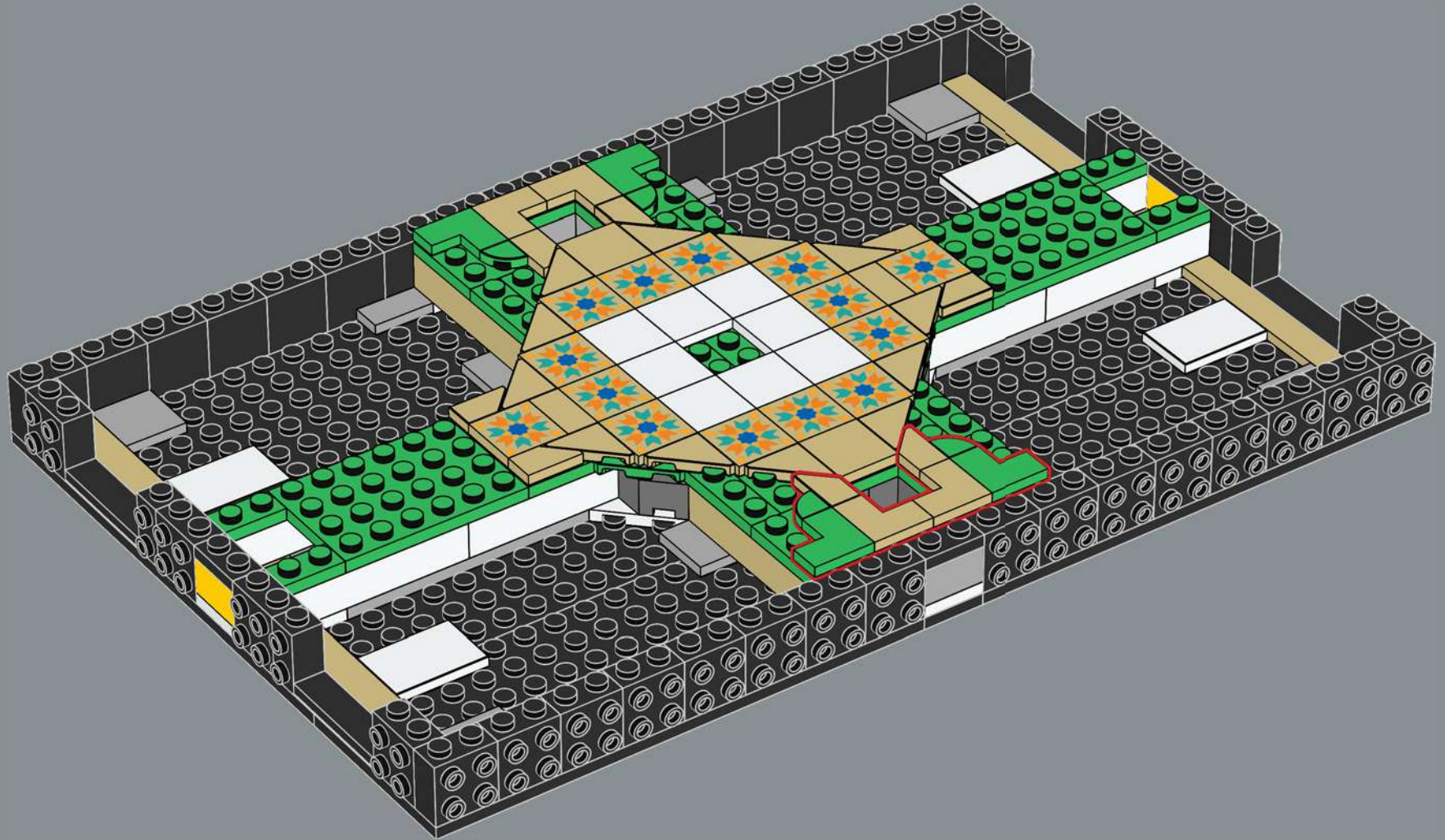

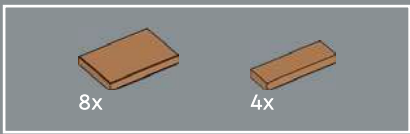

29

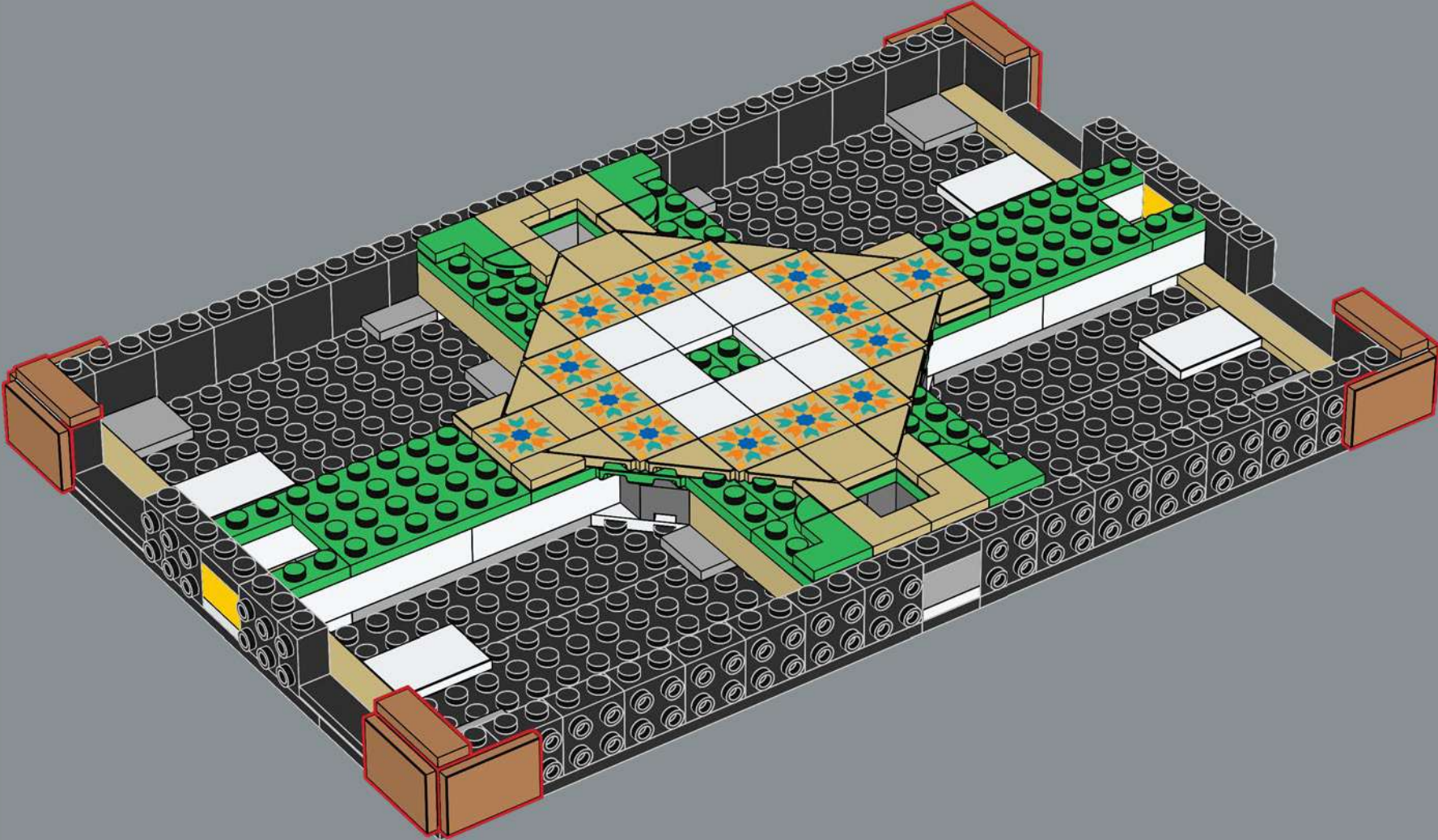



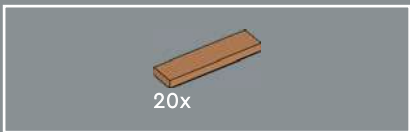

30

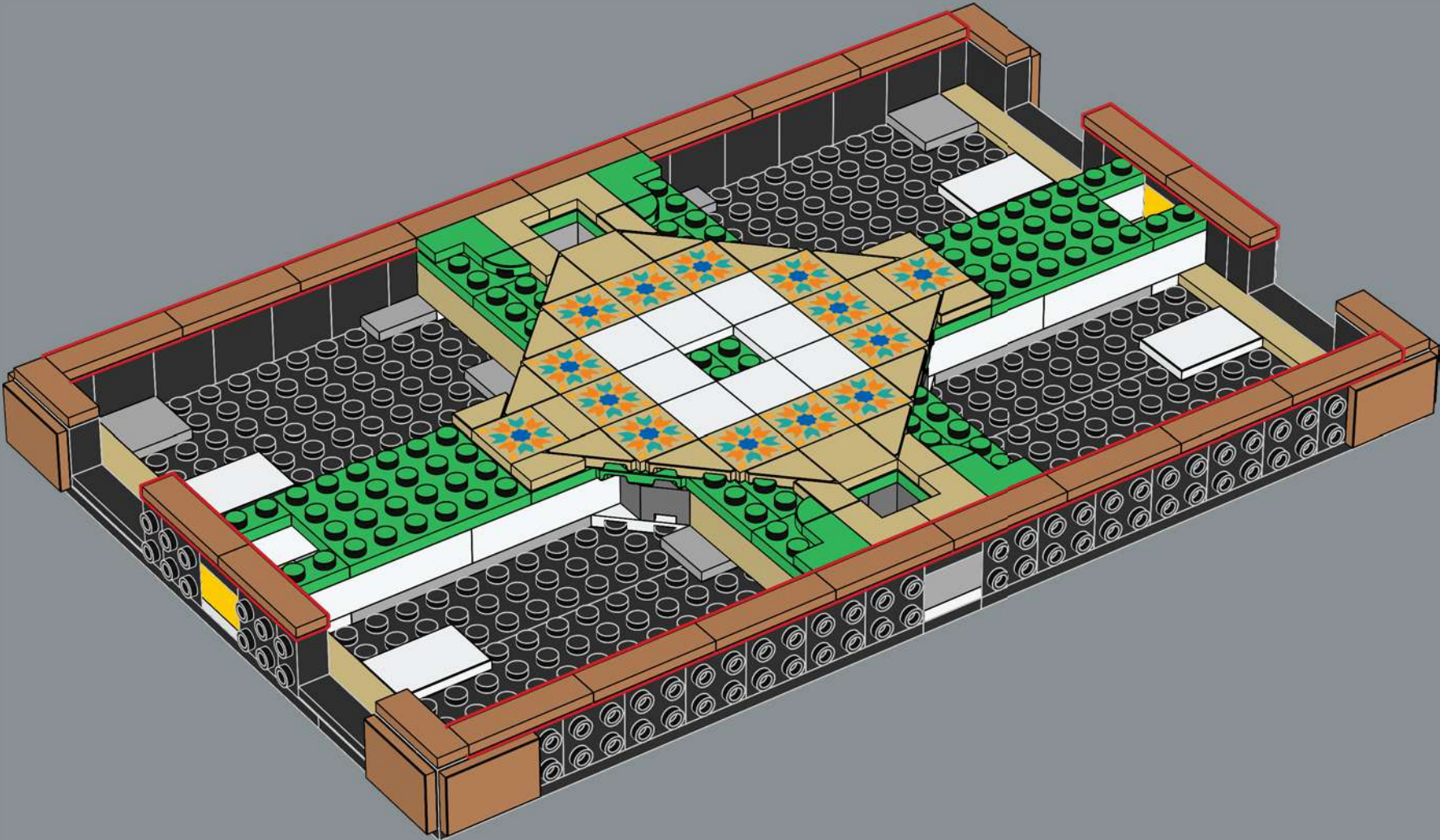



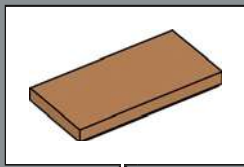

31

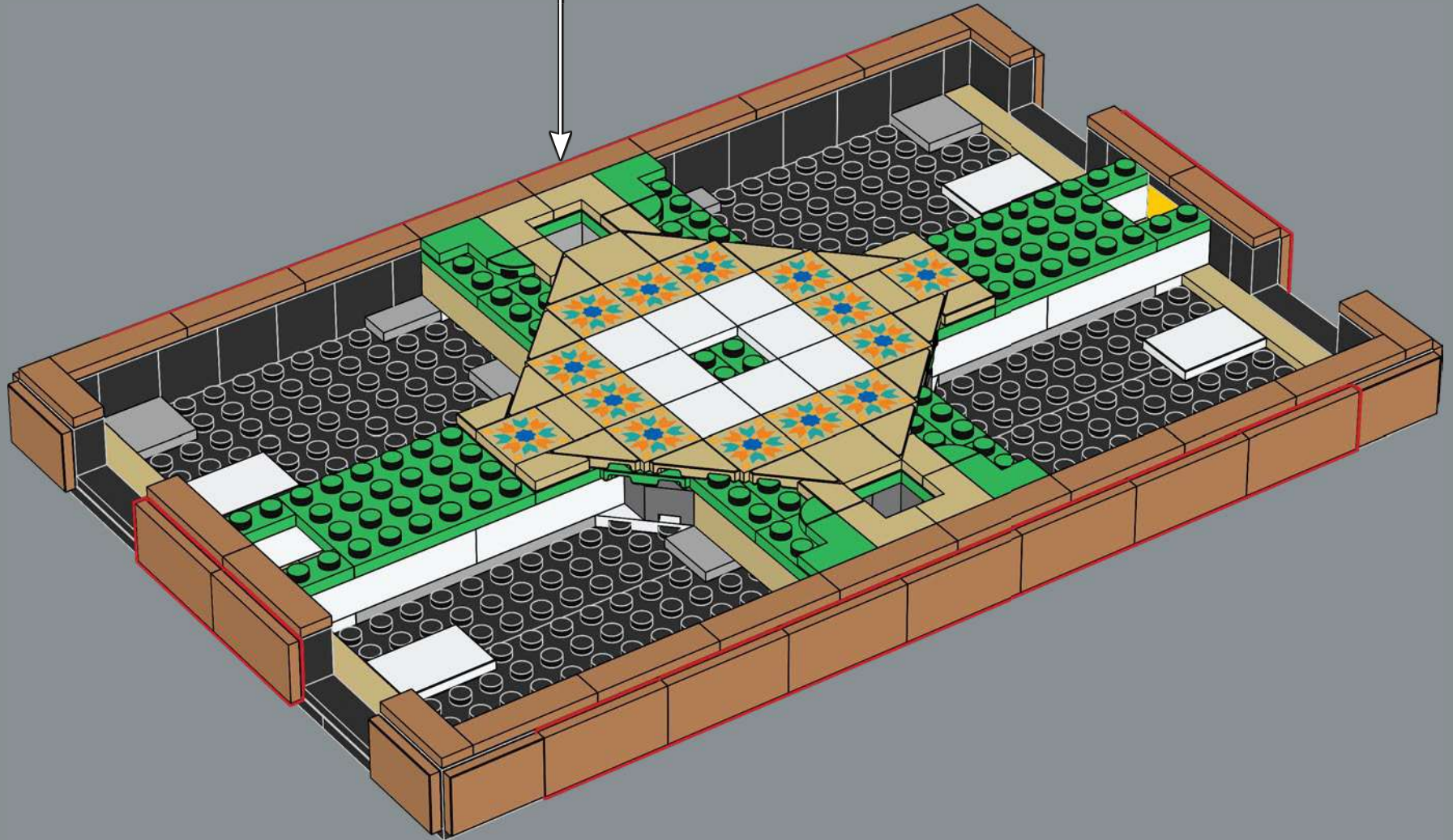

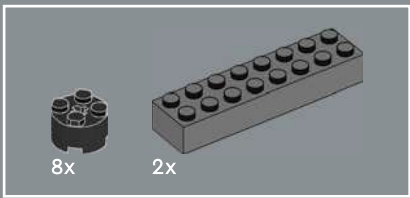

32

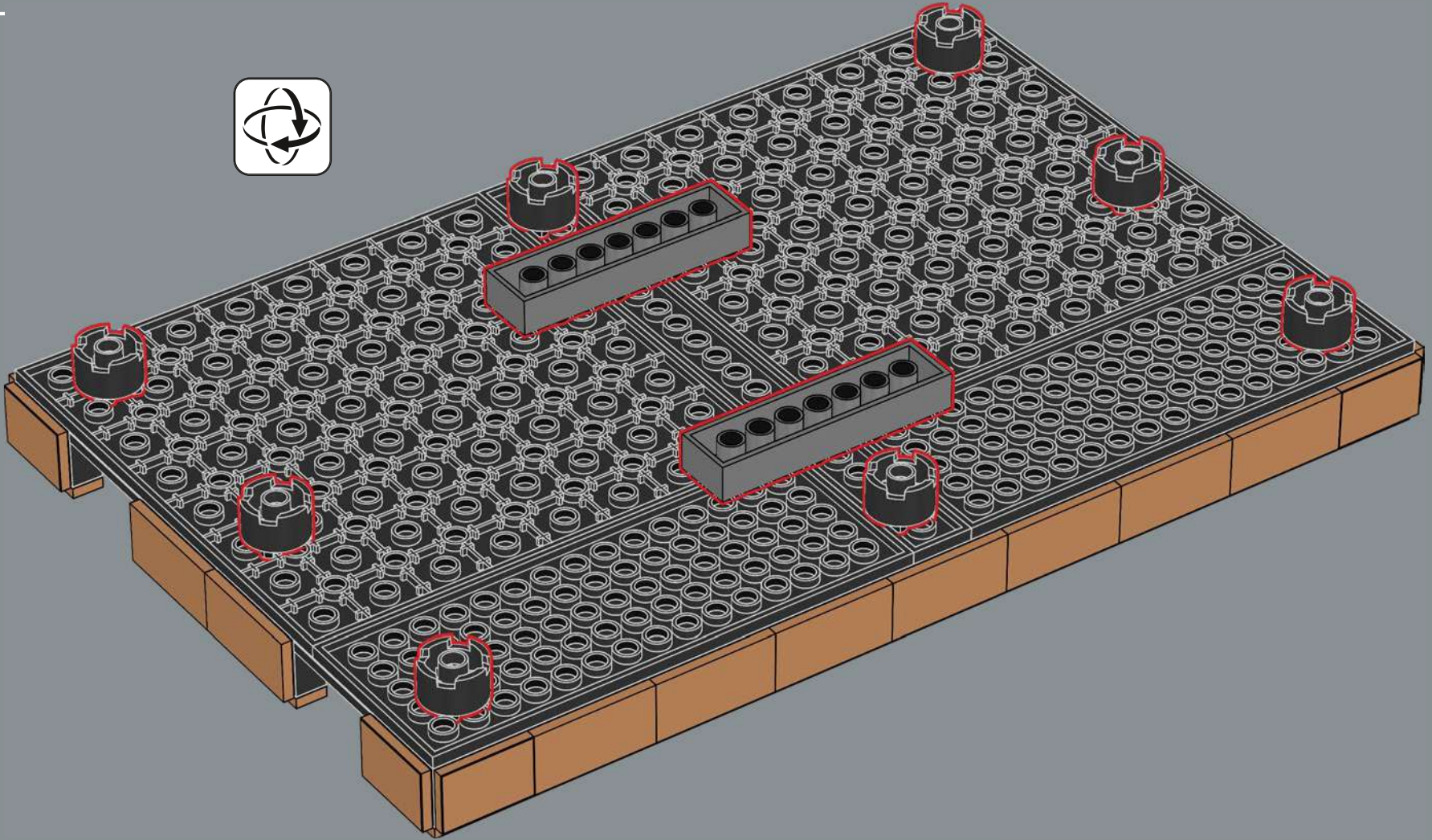



33

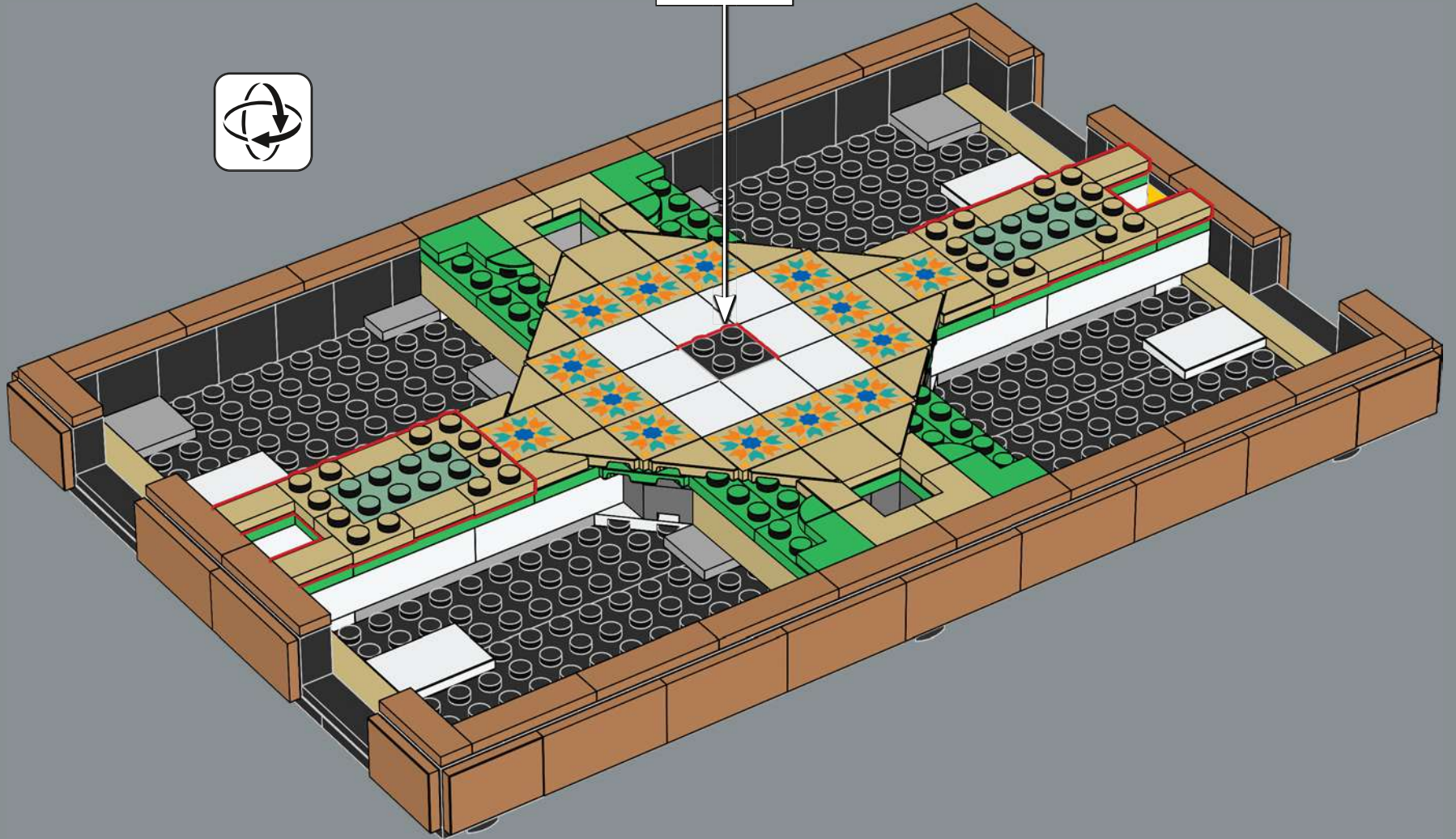



34

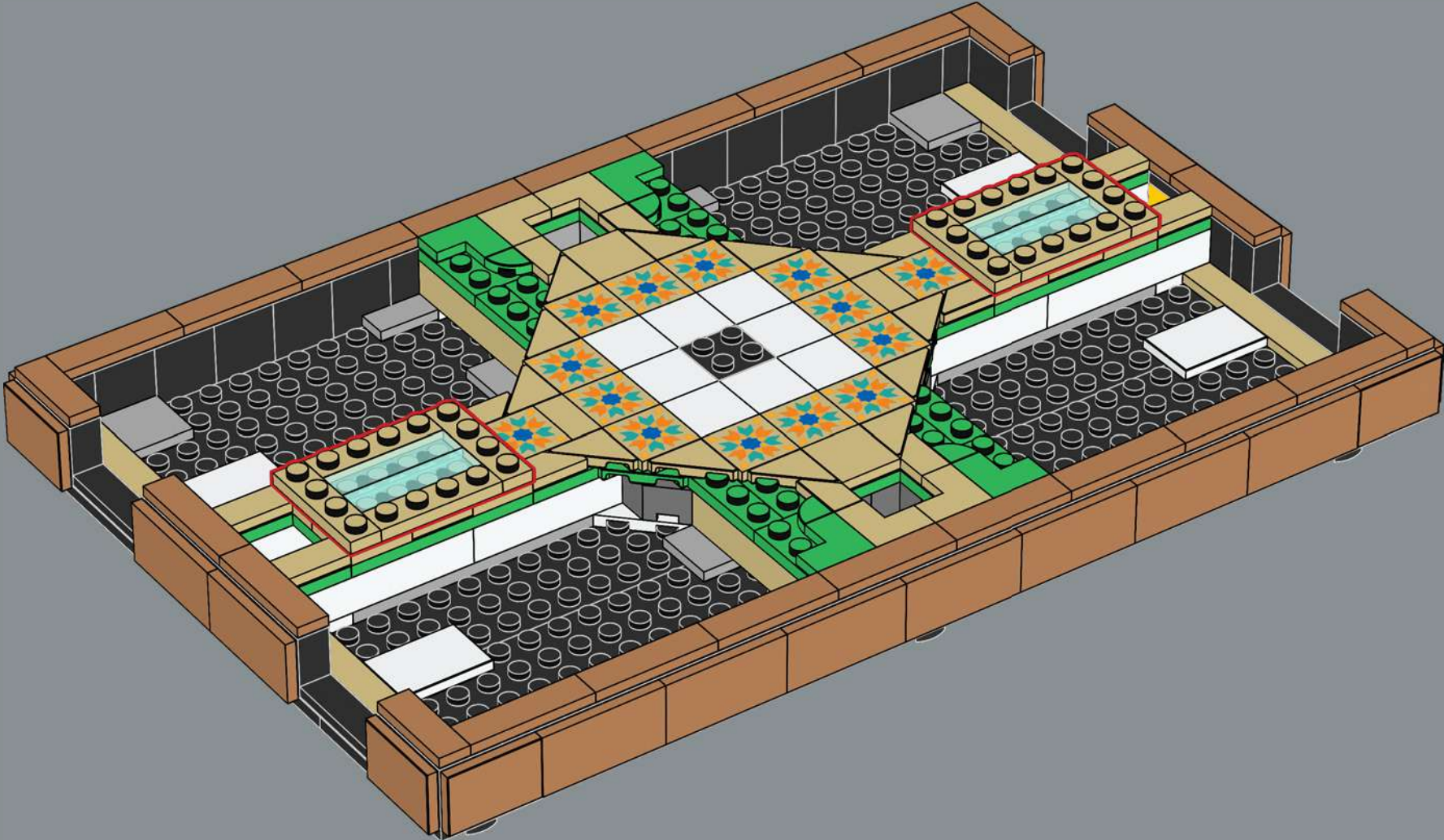

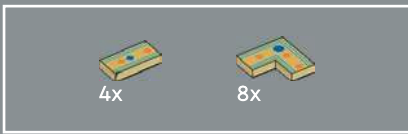

The decorated pieces created for this set were inspired by the *zellij* style of mosaic tilework. They are frequently found in the architecture of ancient historical sites and monuments in countries such as Morocco, Algeria, Tunisia and the Andalusian region of southern Spain.

35

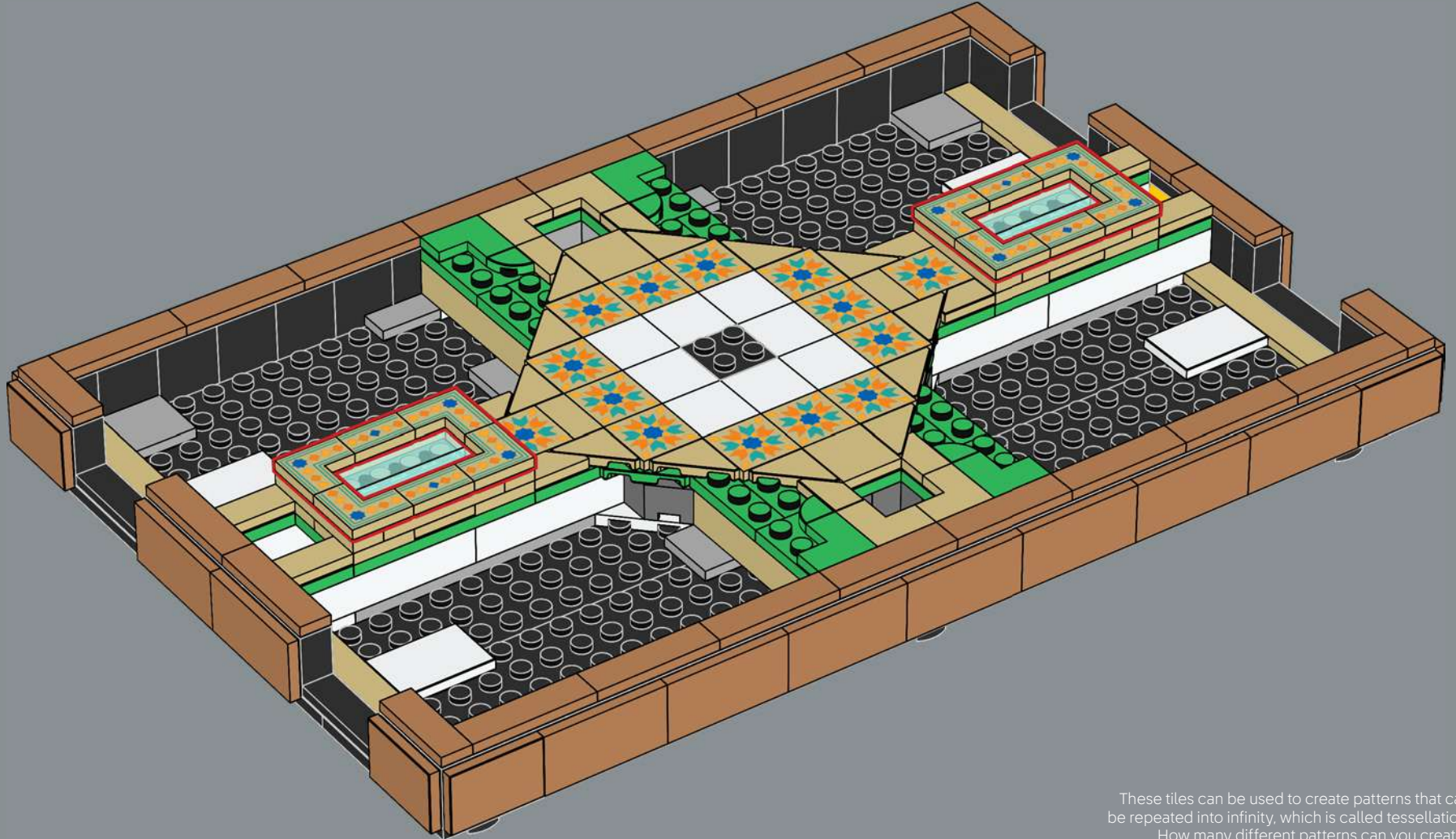

These tiles can be used to create patterns that can be repeated into infinity, which is called tessellation. How many different patterns can you create?

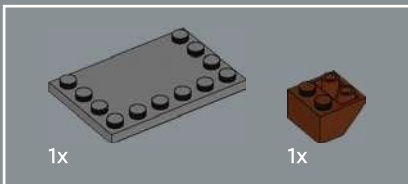
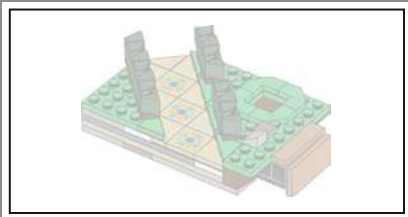

36

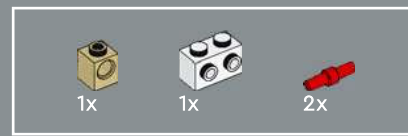
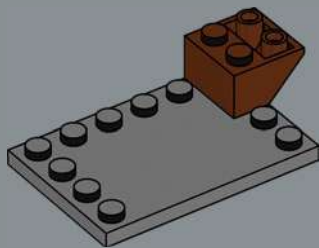

37

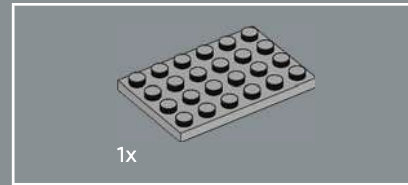
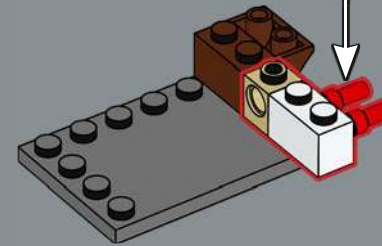
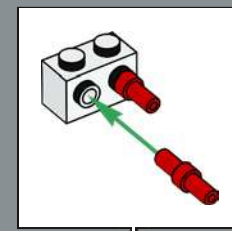

38

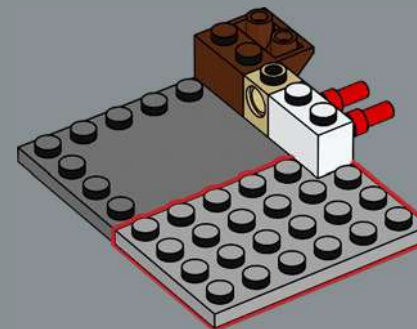



39

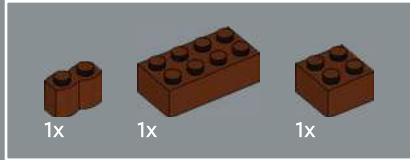
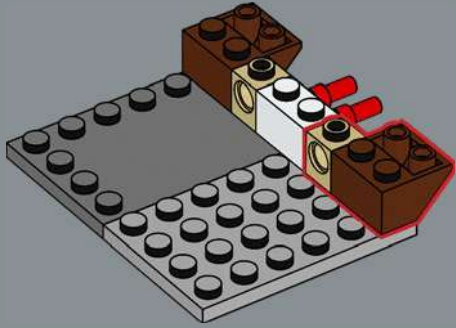

40

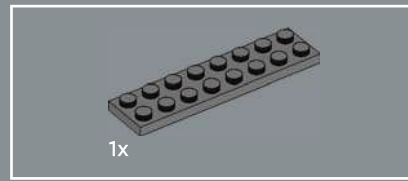
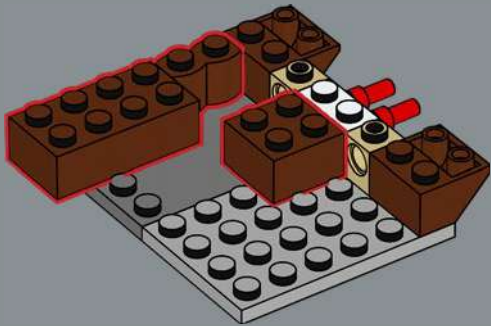

41

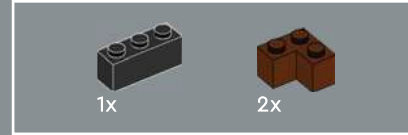
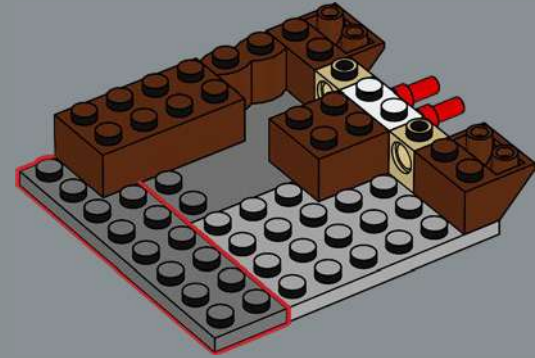

42

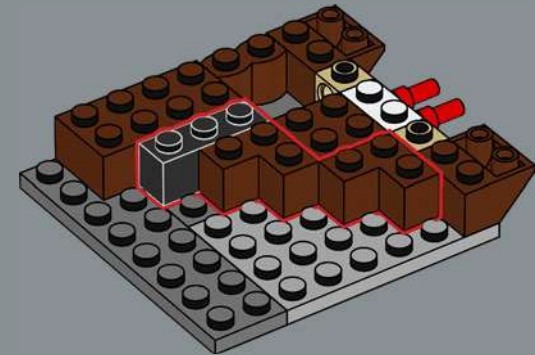

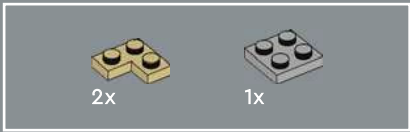

43

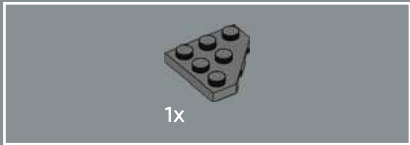
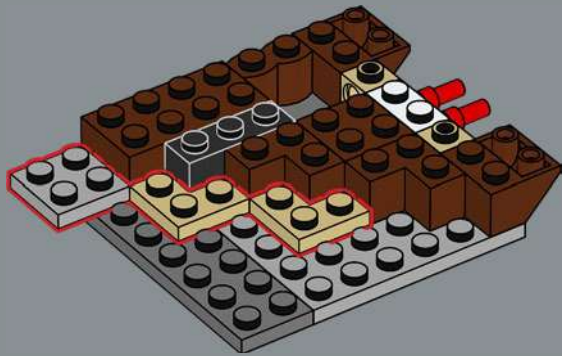

44

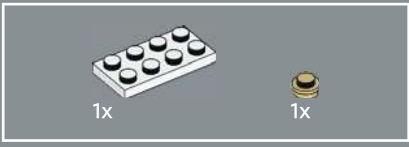
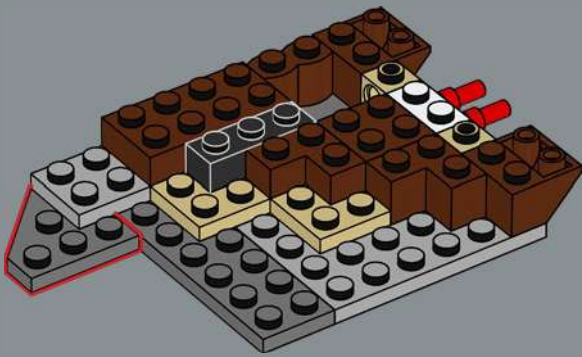

45

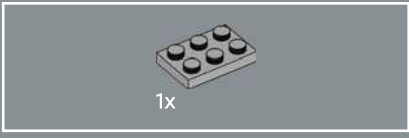
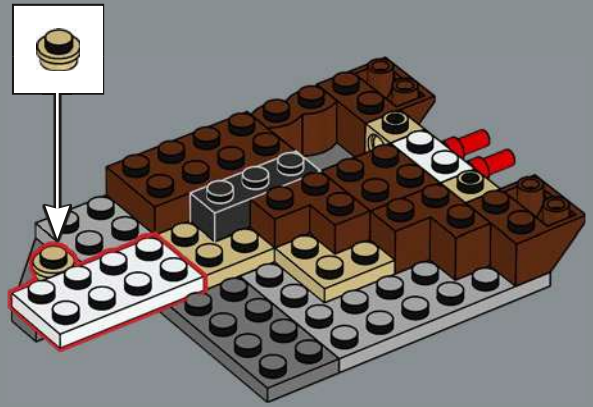

46

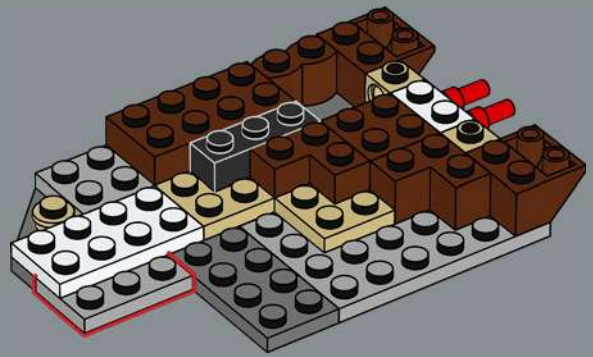



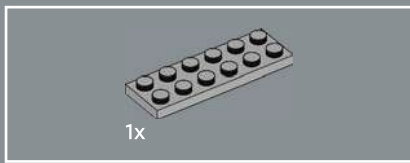

47

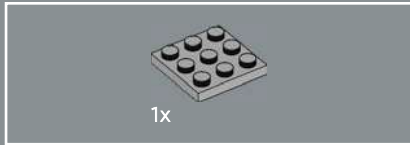
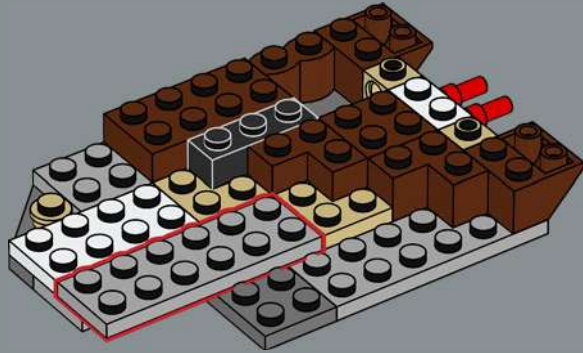

48

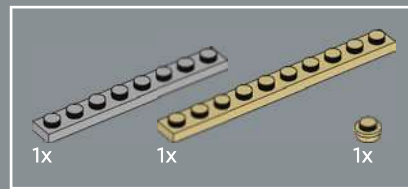
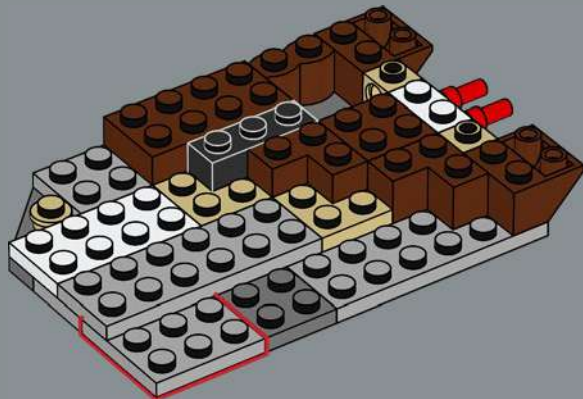

49

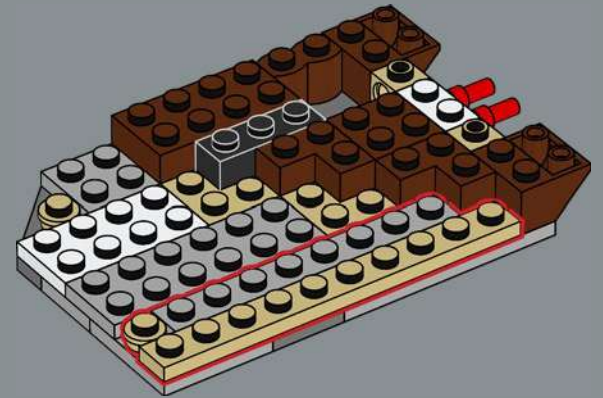

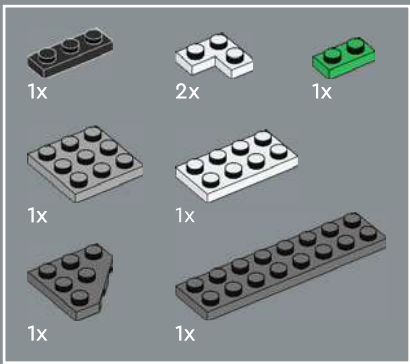

50

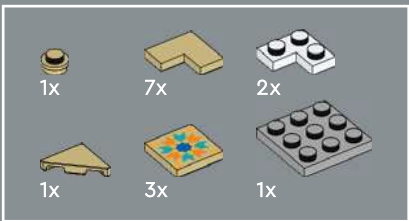

51

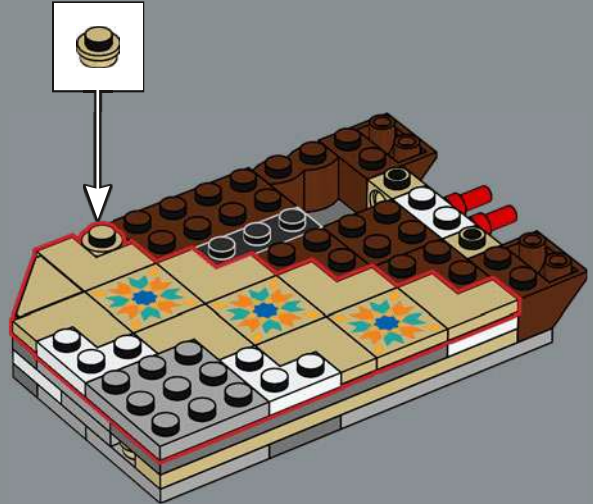

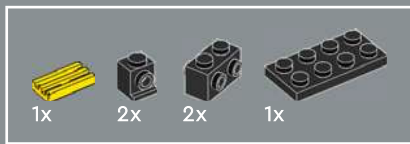

52

1

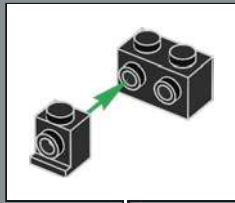

2

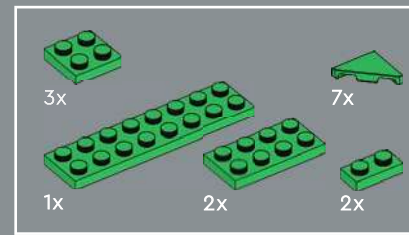
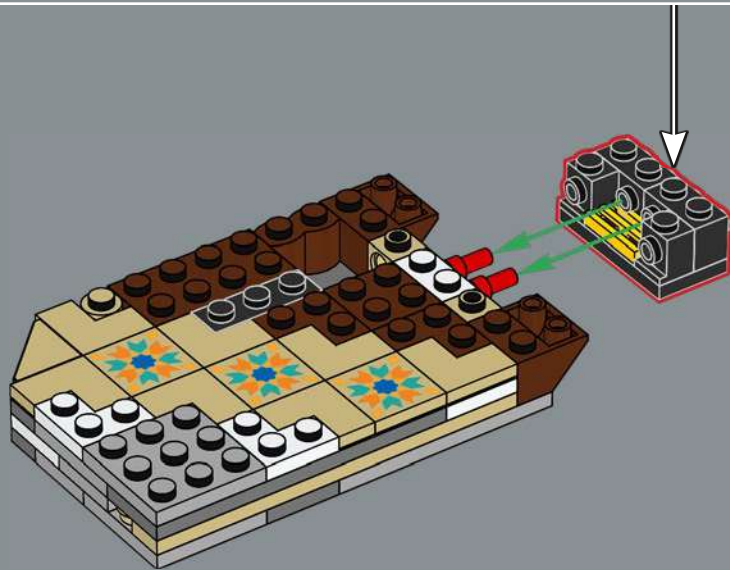
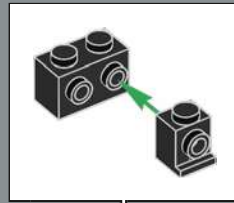
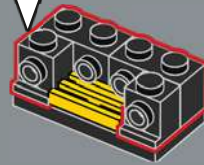

53

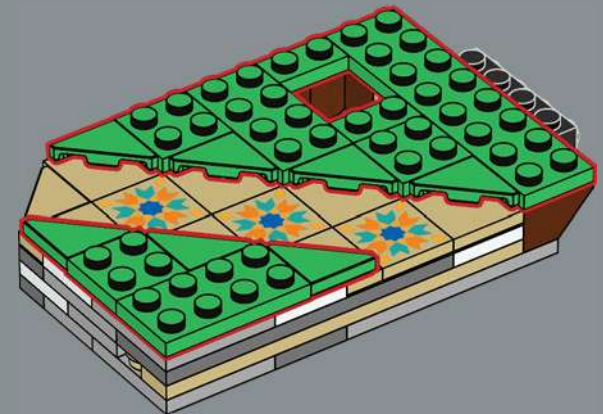



54

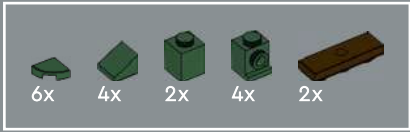
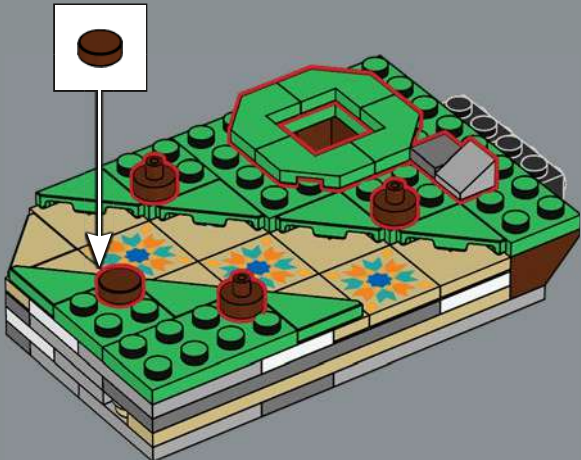

55

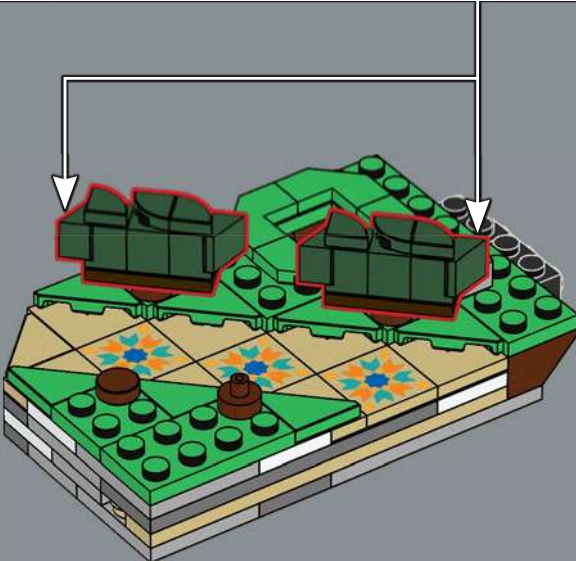
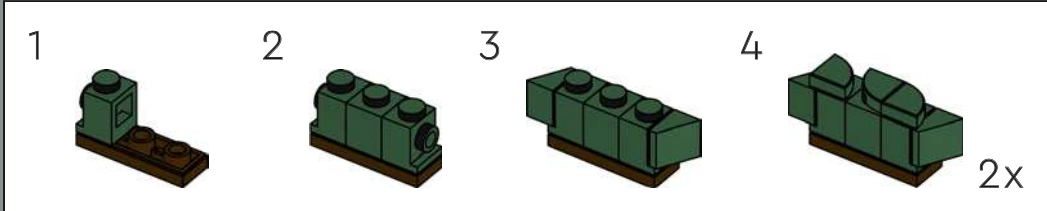

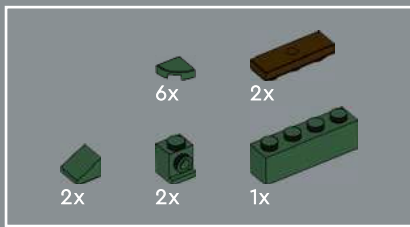

56

1



2

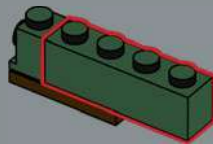

3

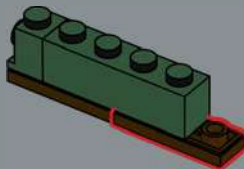

4

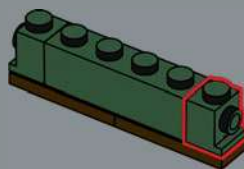

5

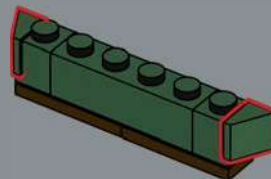

6

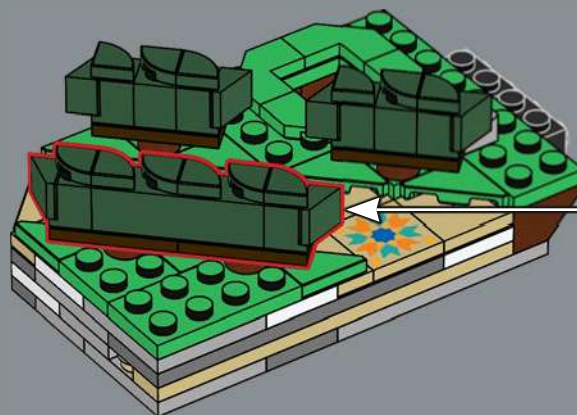
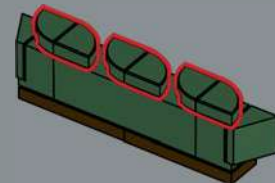

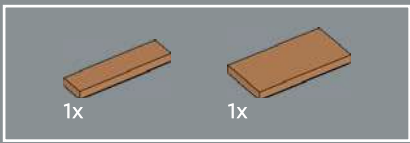

57

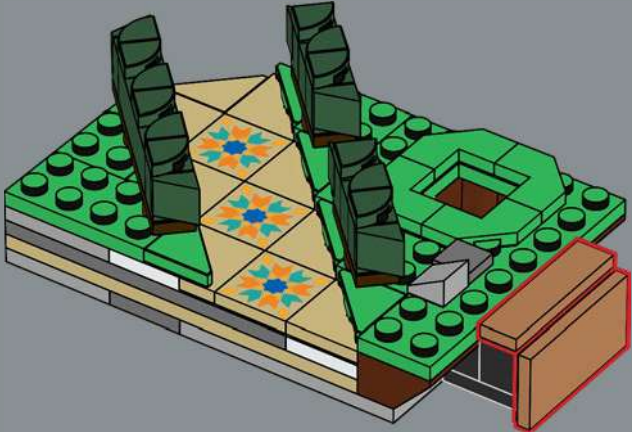

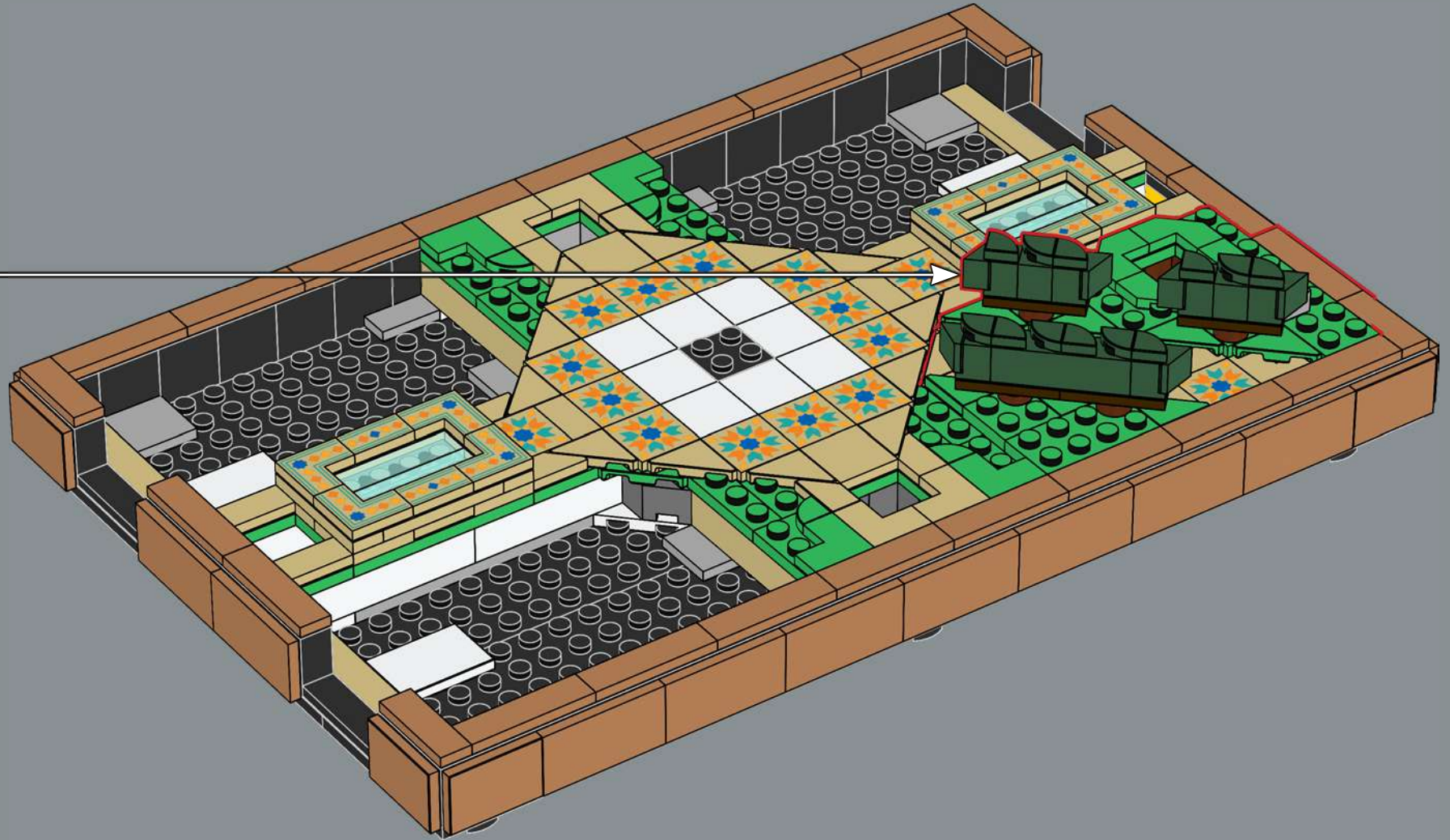

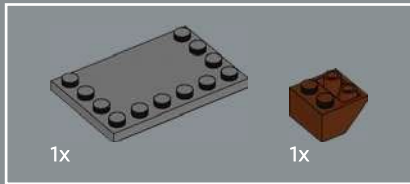
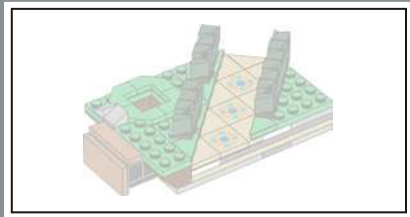

59

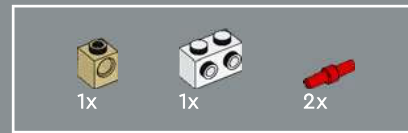
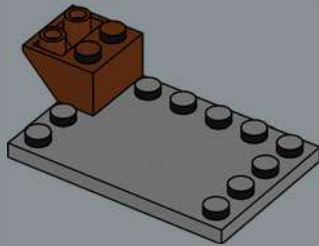

60

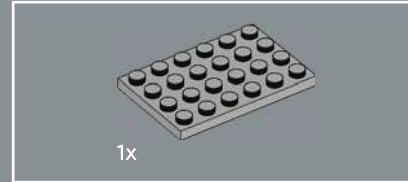
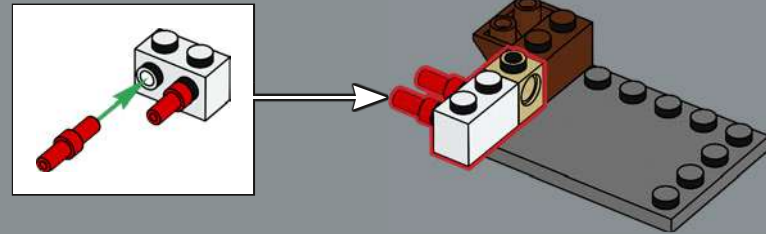

61

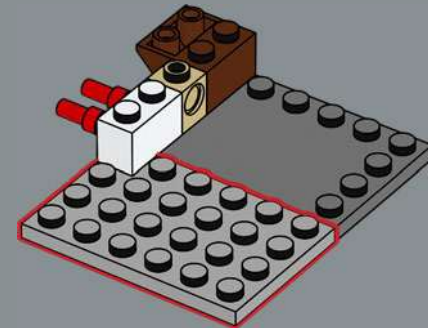





62

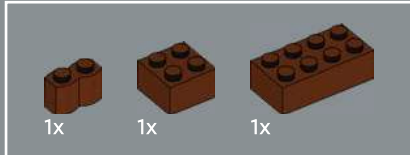
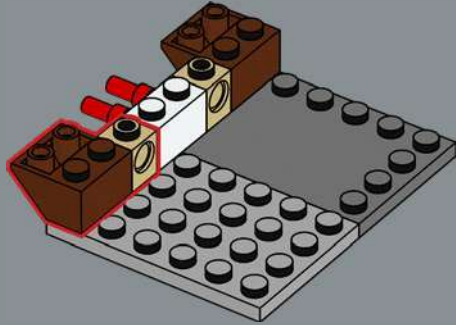

63

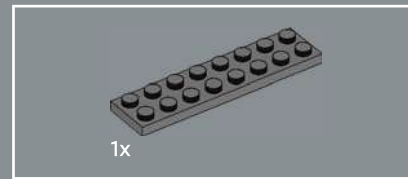
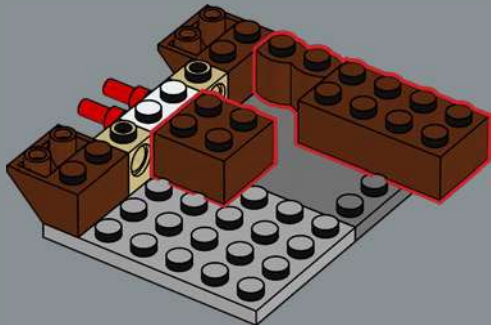

64

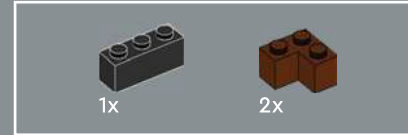
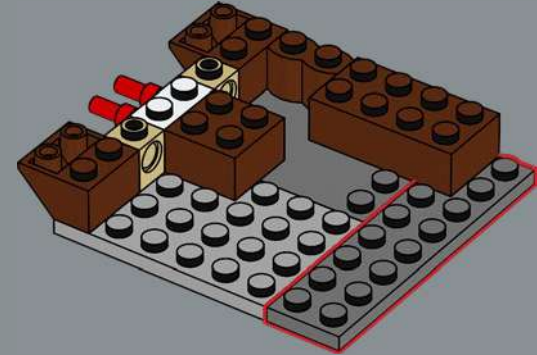

65

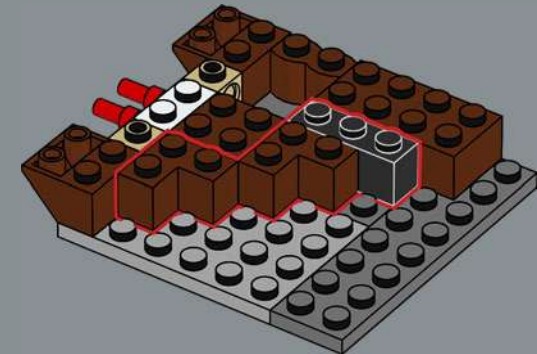

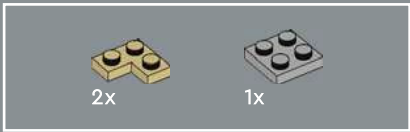

66

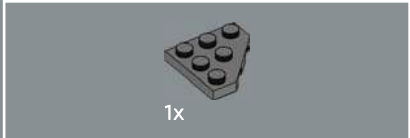
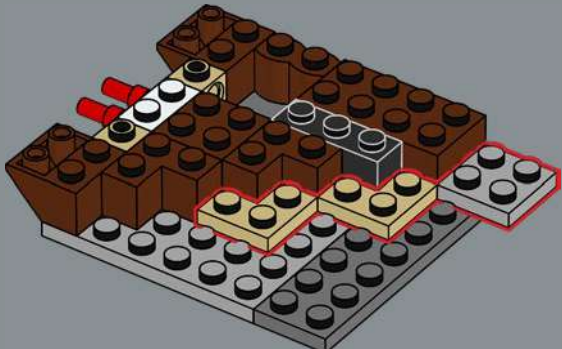

67

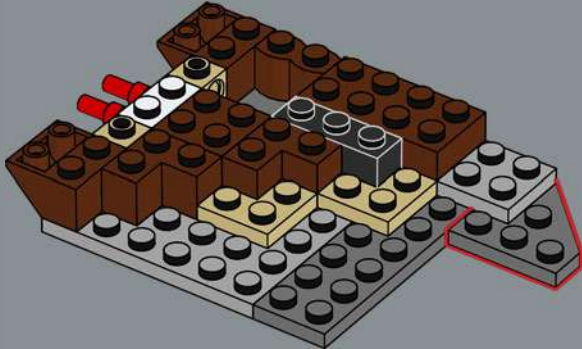

68

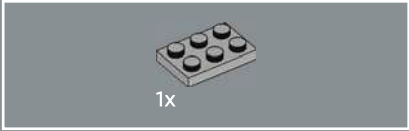
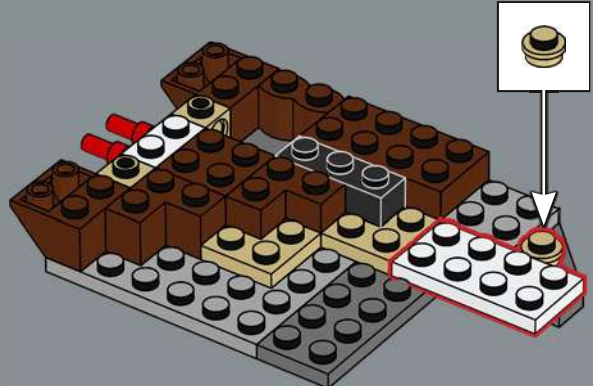

69

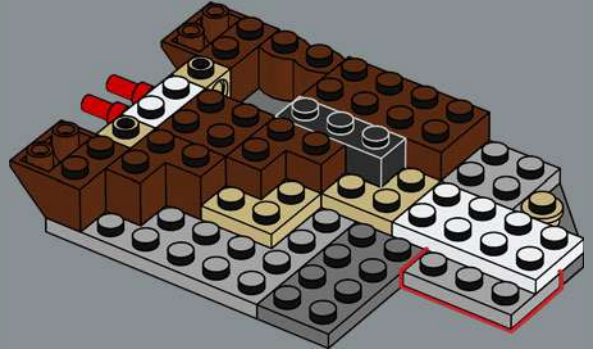

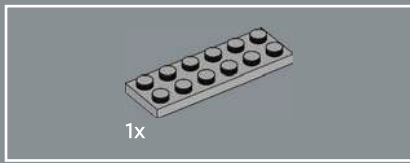

70

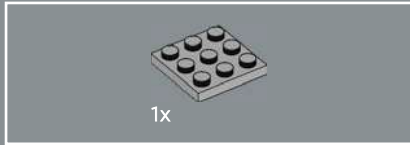
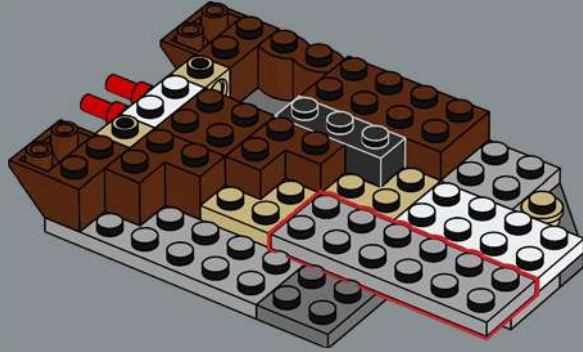

71

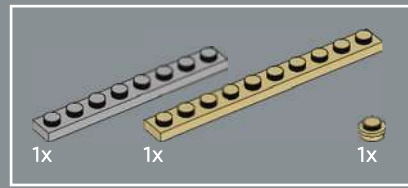
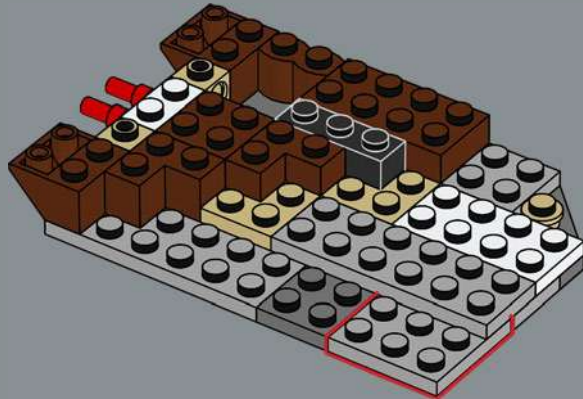

72

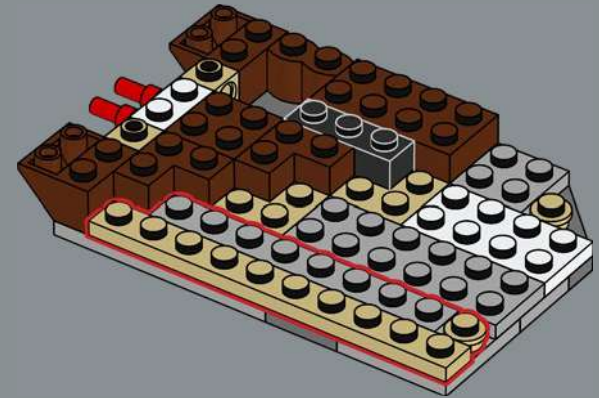

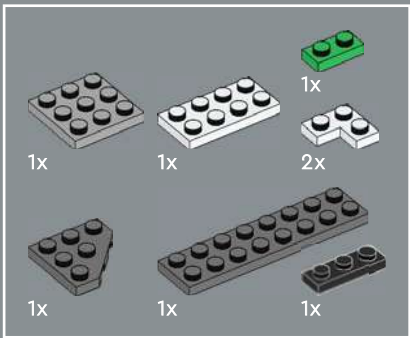

73

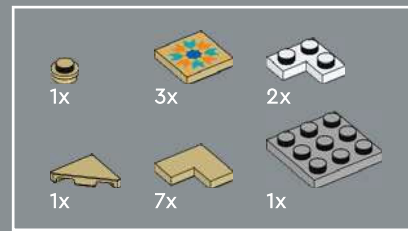

74

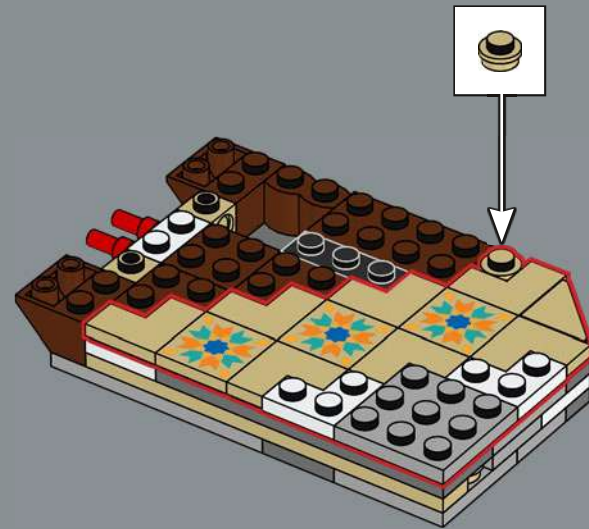

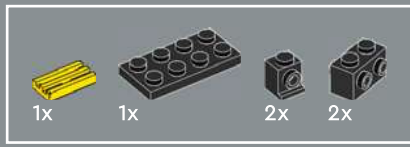

75

1

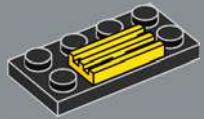

2

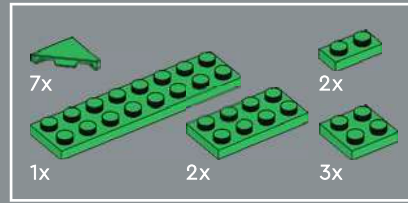
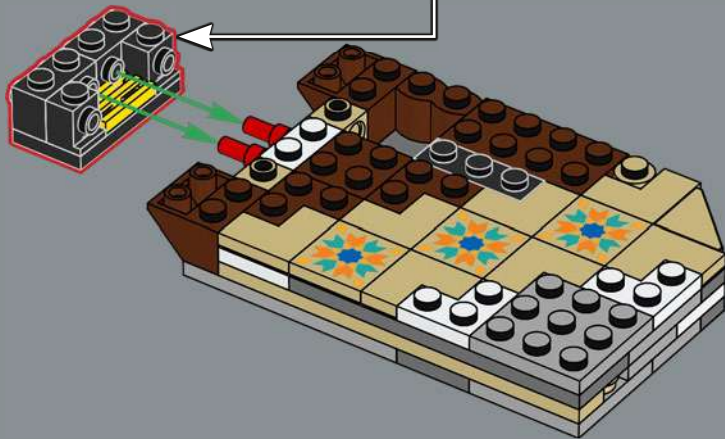
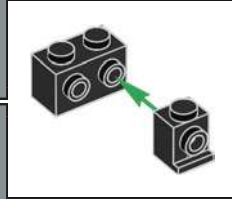
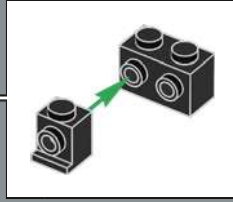
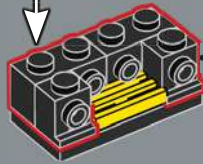

76

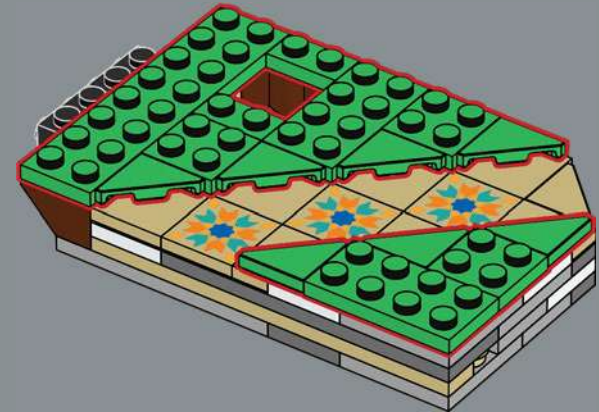

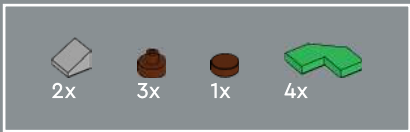

77

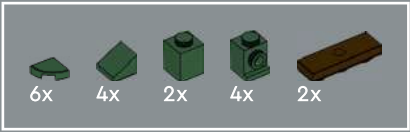
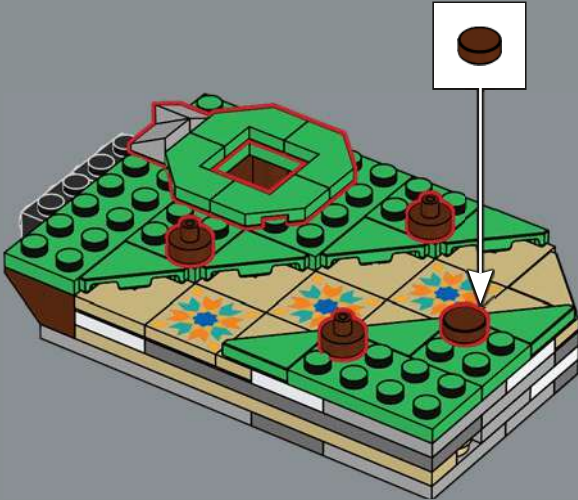

78

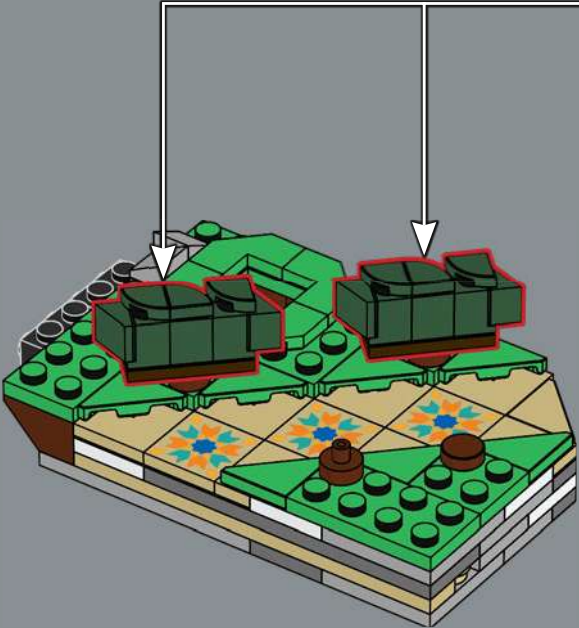
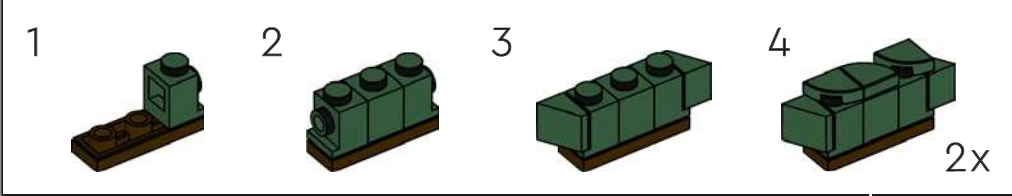

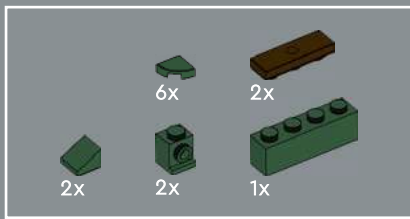

79

1



2

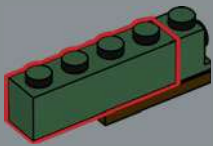

3

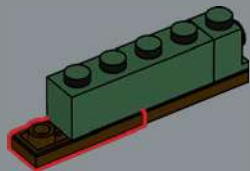

4

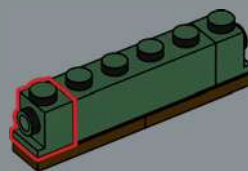

5

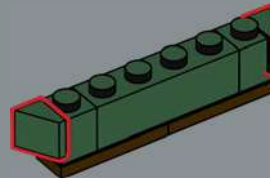

6

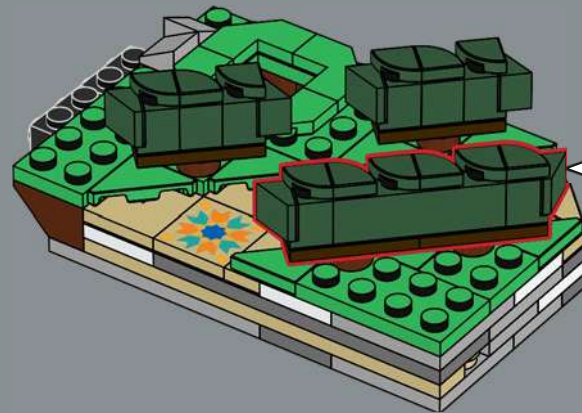
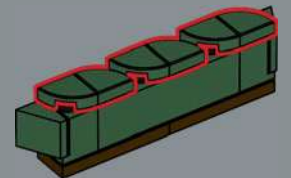

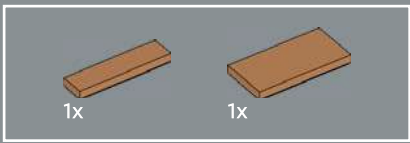

80

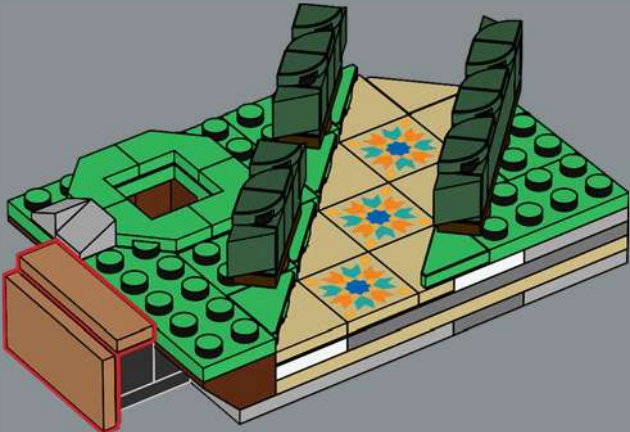



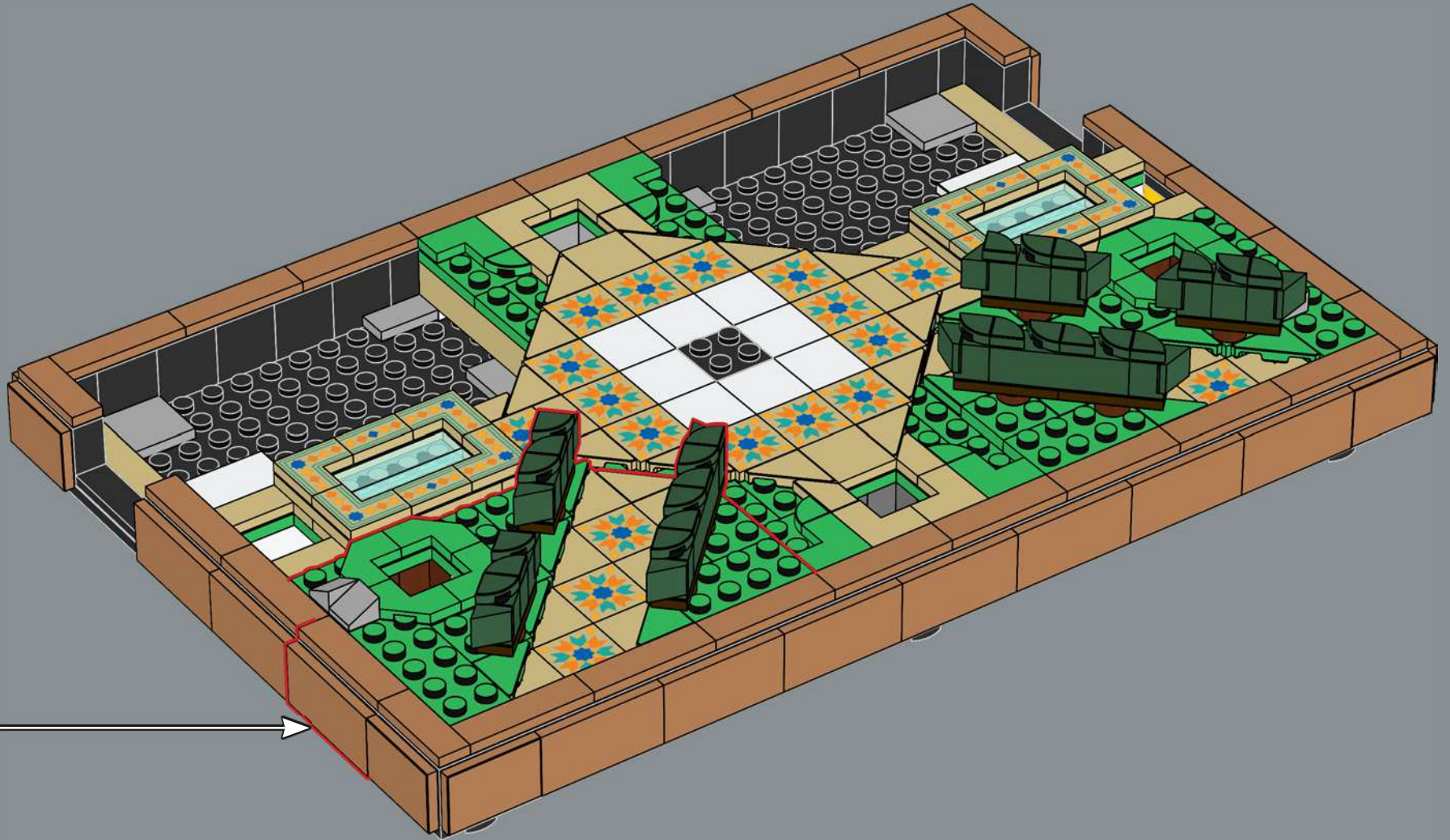

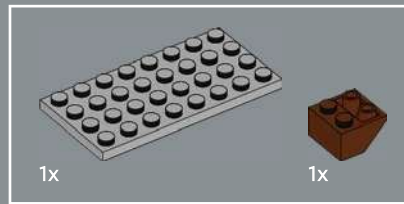
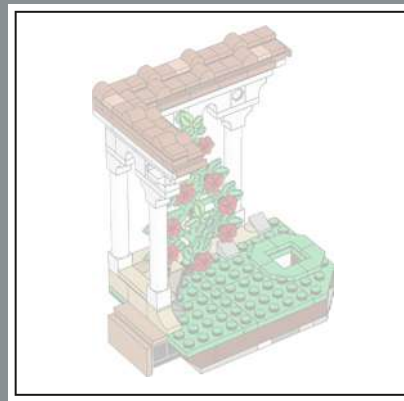

82

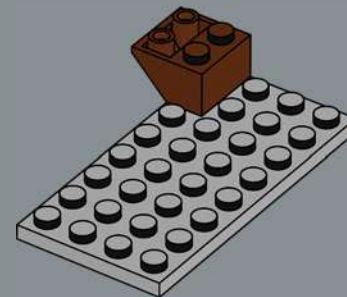

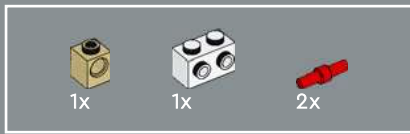

83

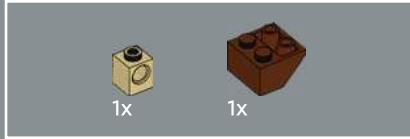
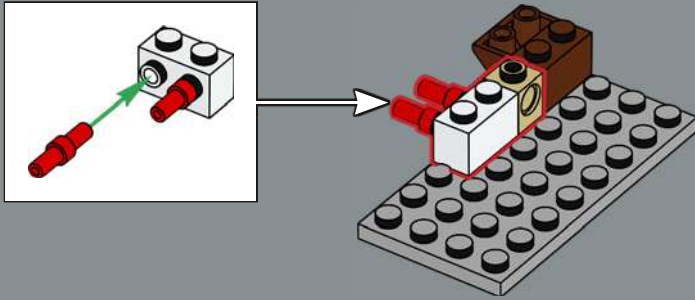

84

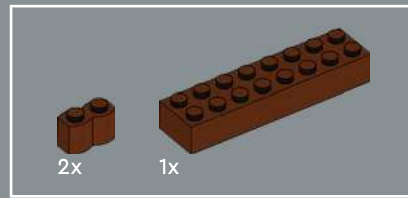
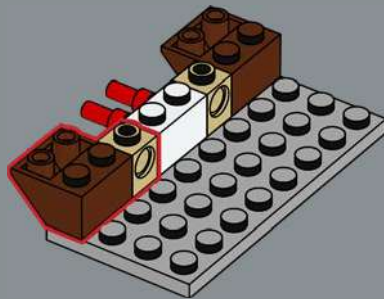

85

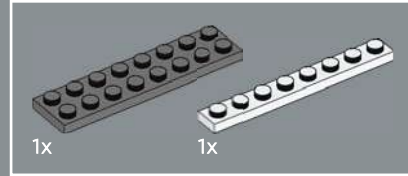
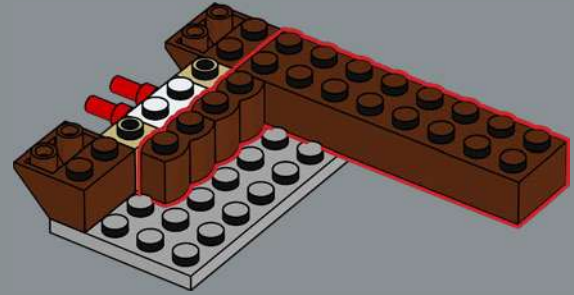

86

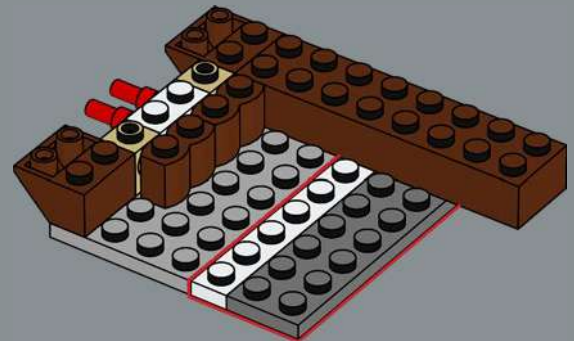

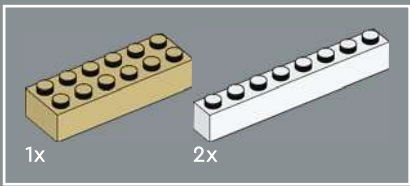

87

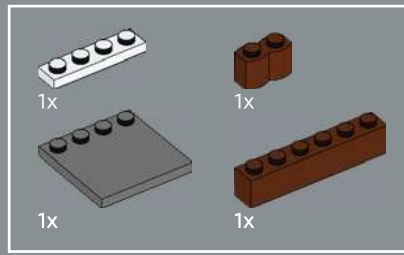
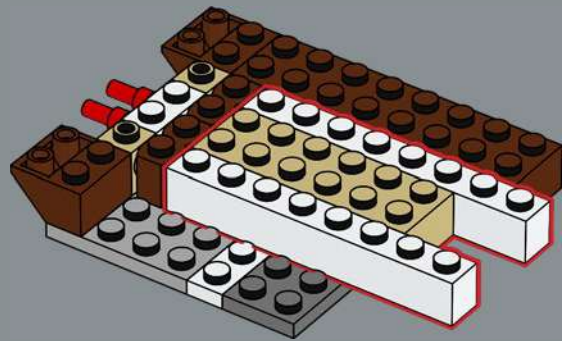

88

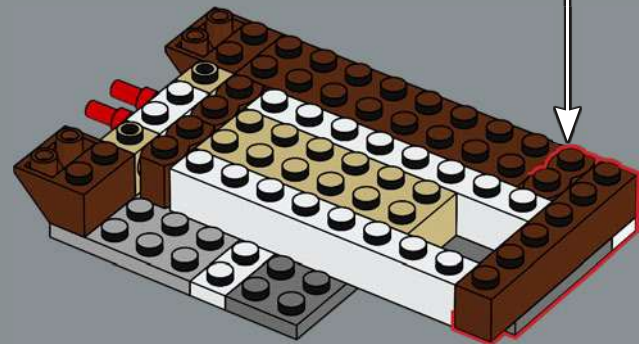
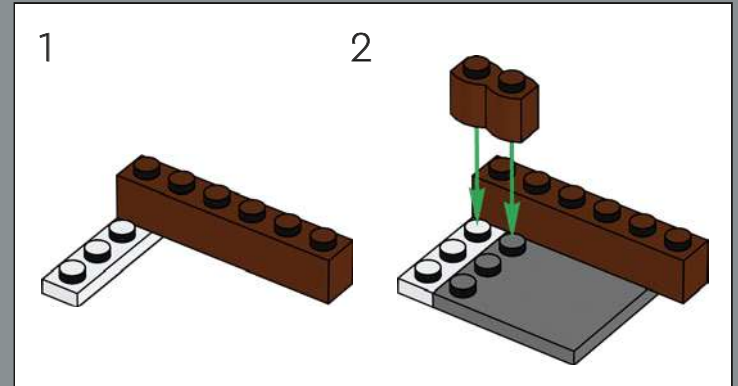

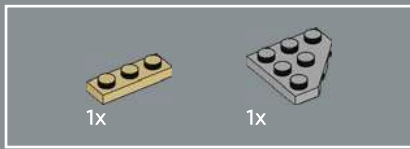

89

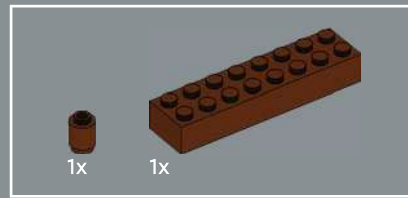
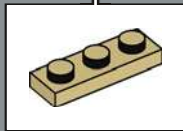
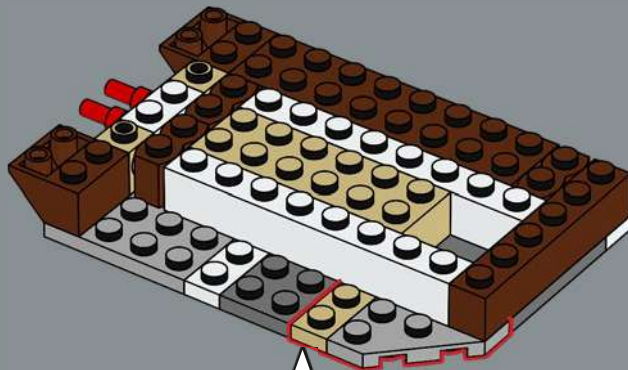

90

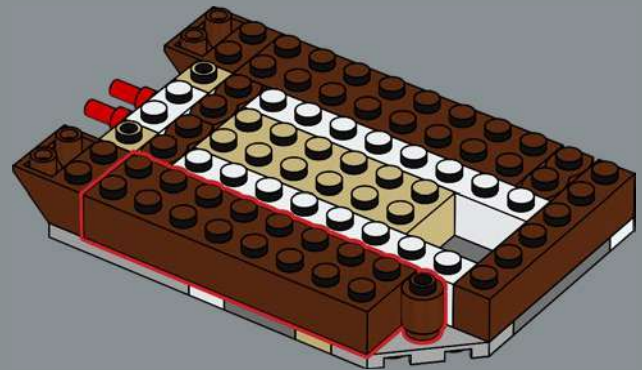

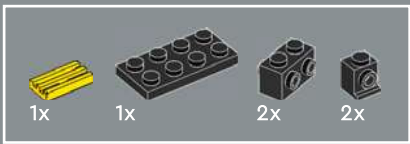

91

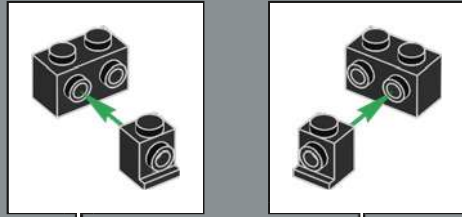

1

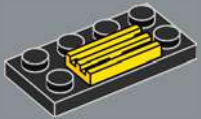

2

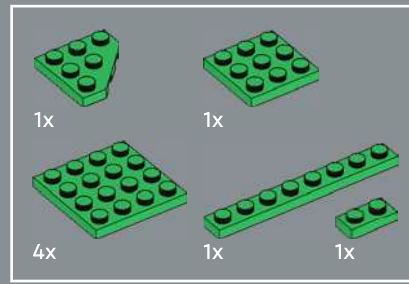
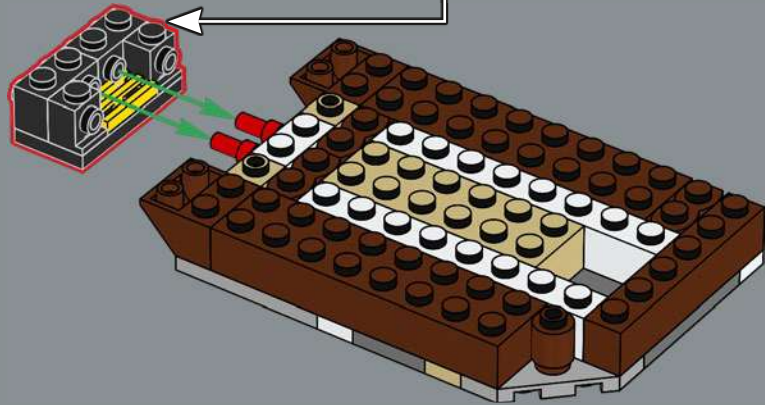
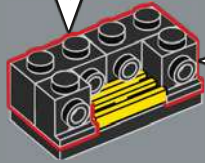

92



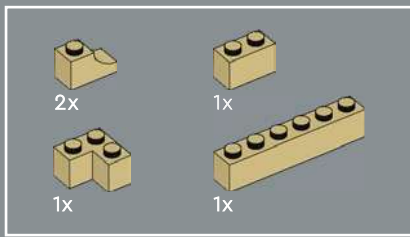

93

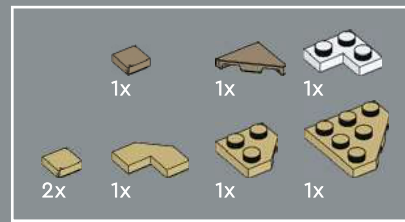
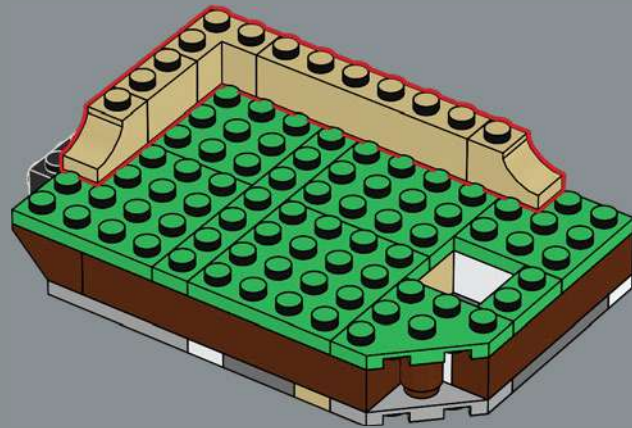

94

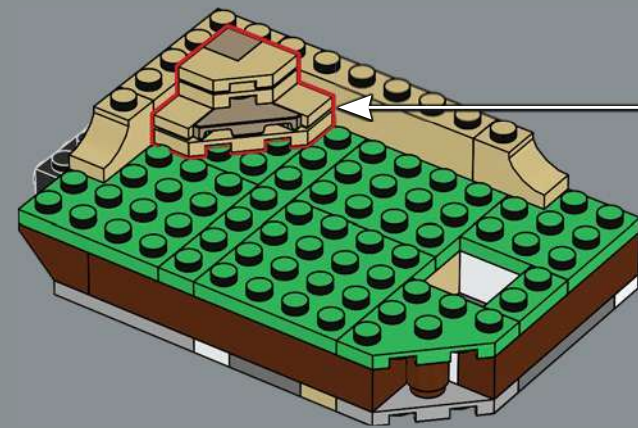
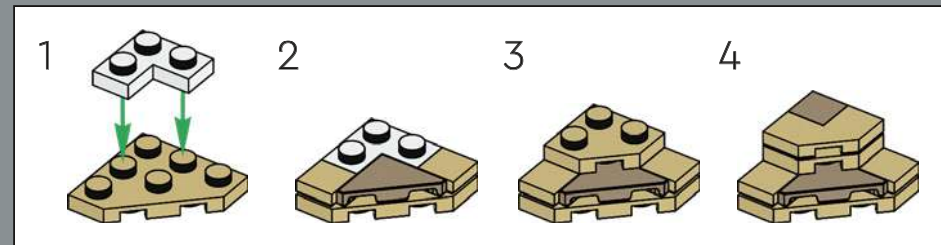



95

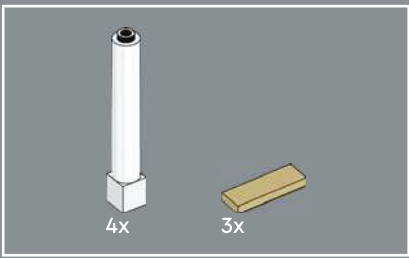
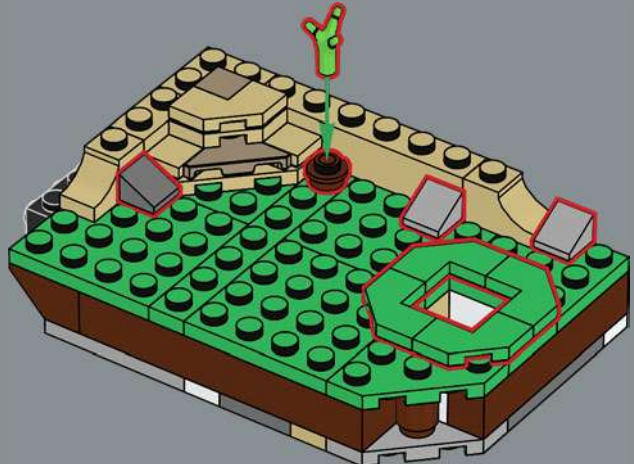

96

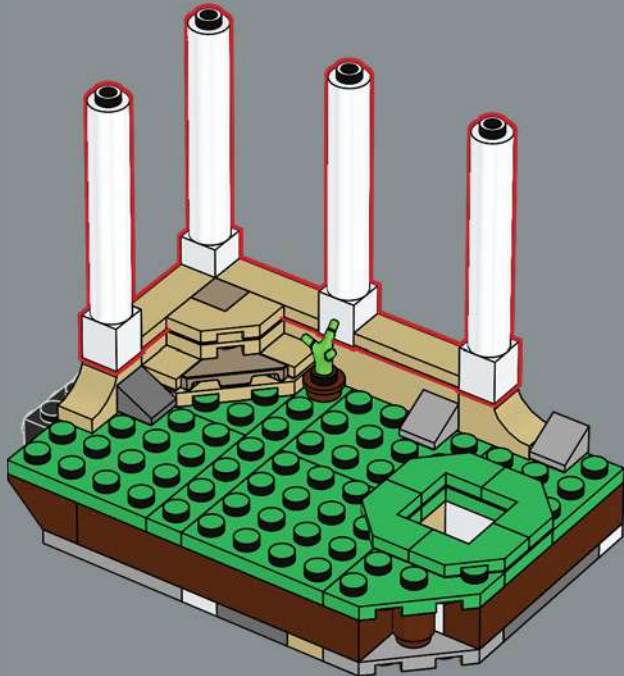



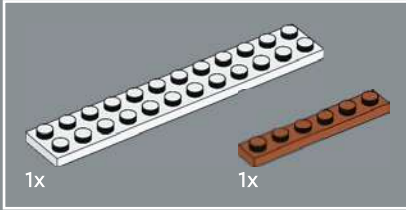
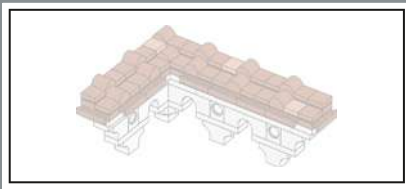

97

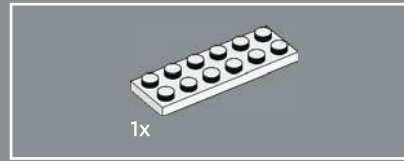
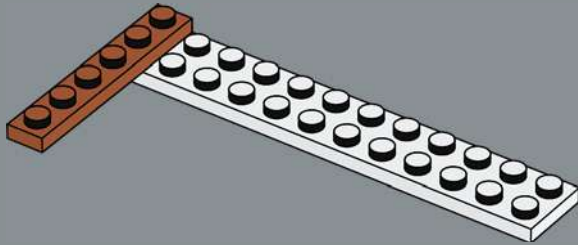

98

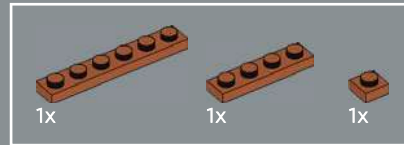
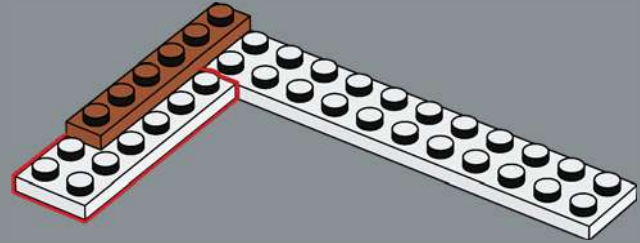

99

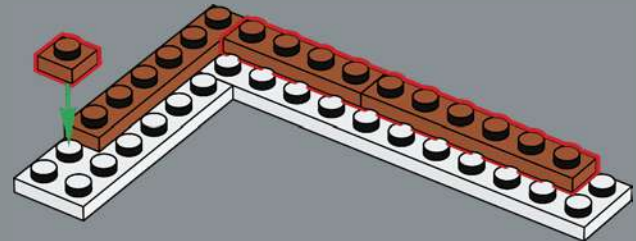



100

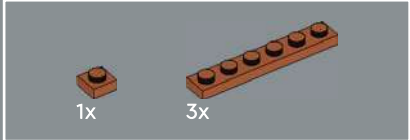
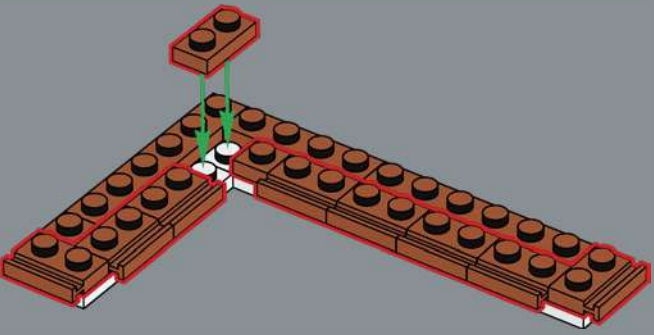

101

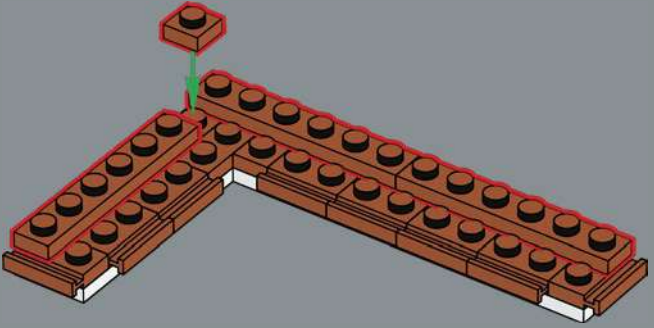

102

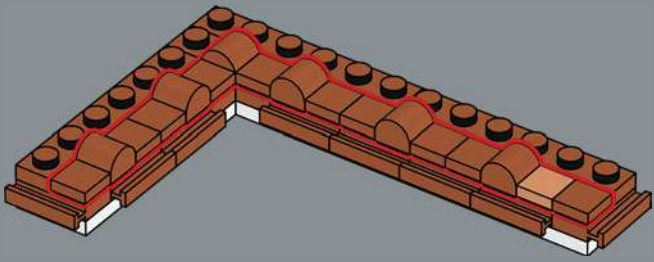

103

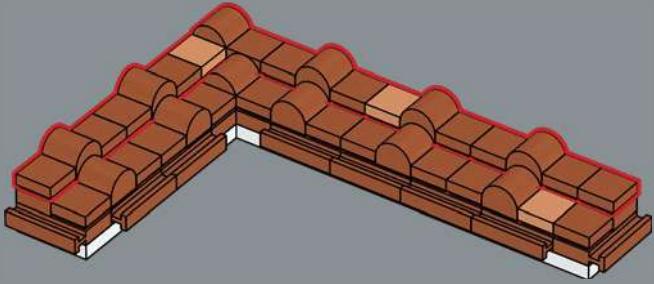

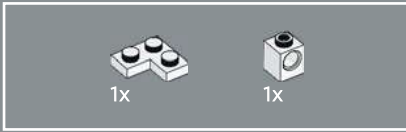
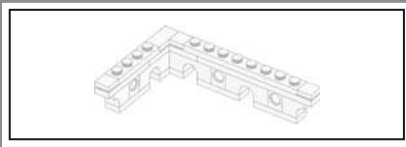

104

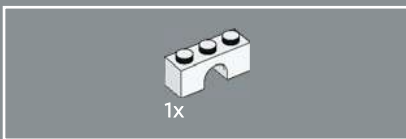
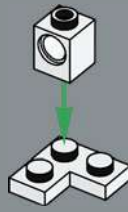

105

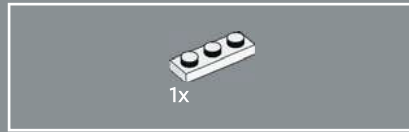

106

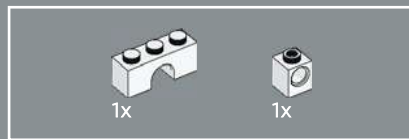
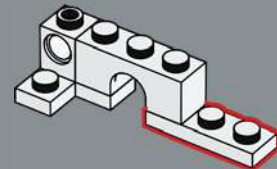

107

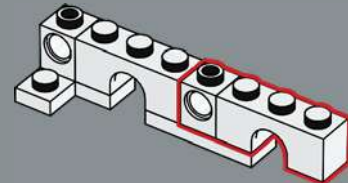

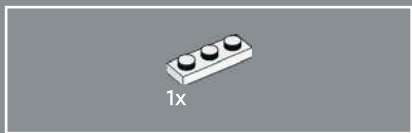

108

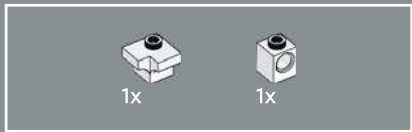
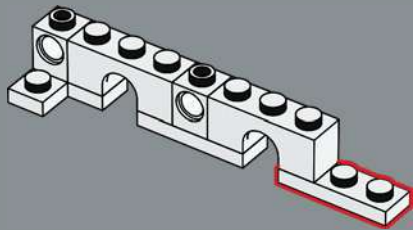

109

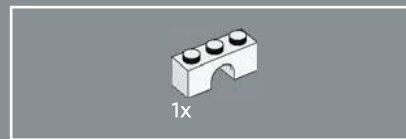
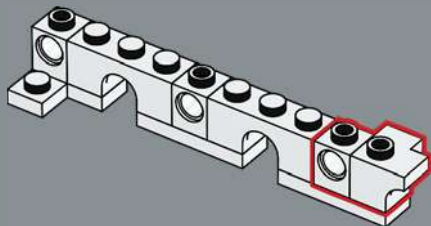

110

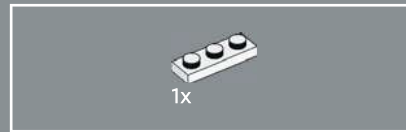
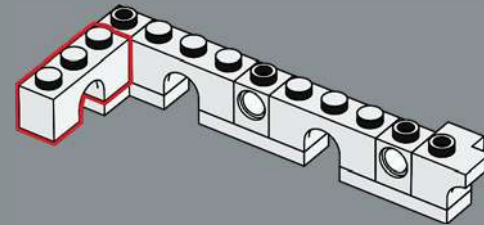

111

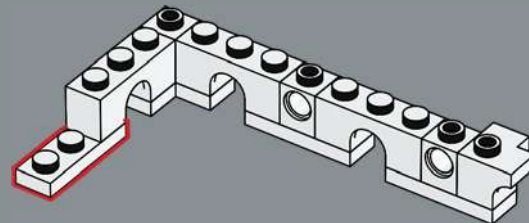

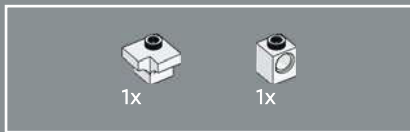

112

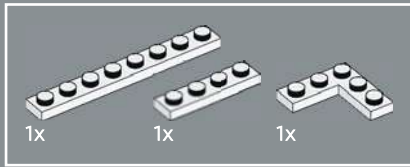
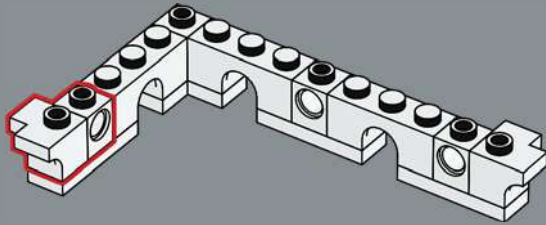

113

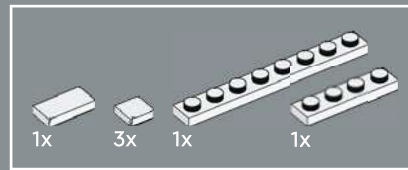
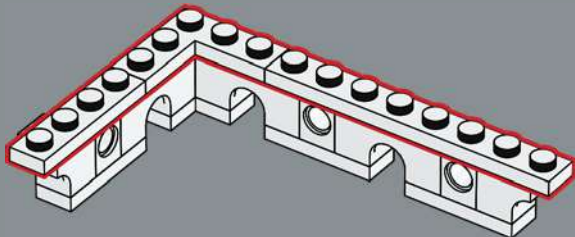

114

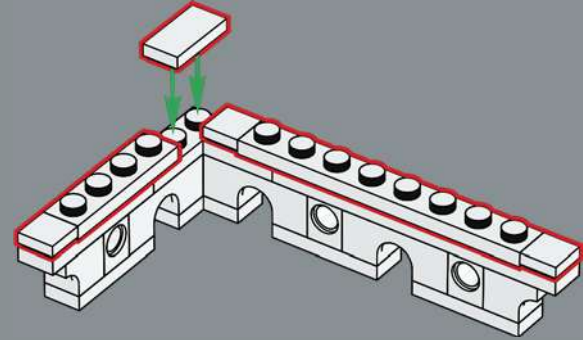

115

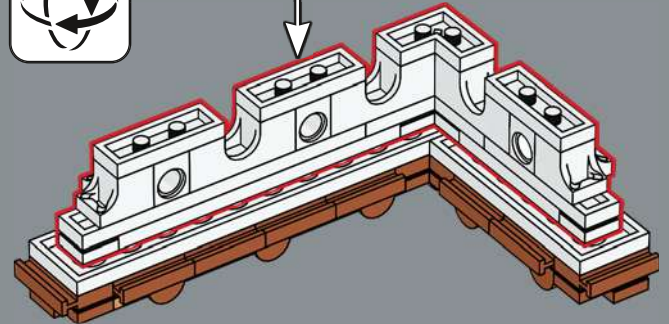

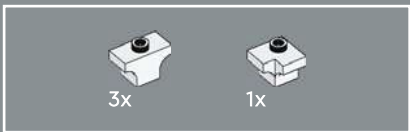

116

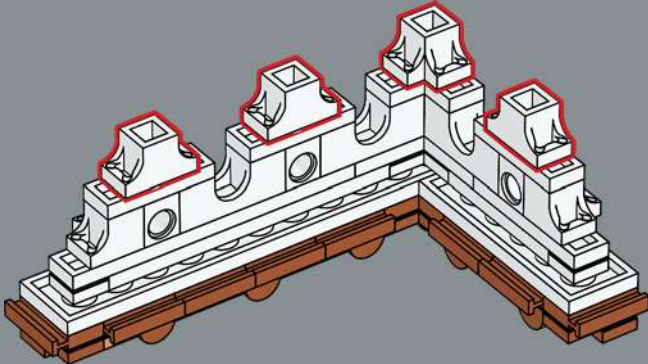

117



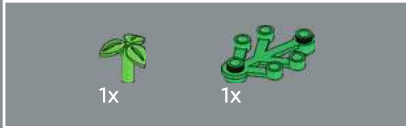
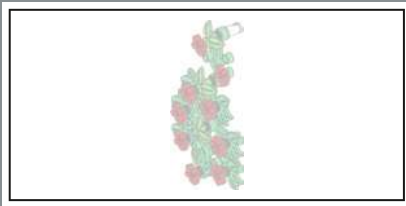

118

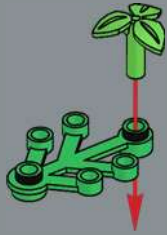

119

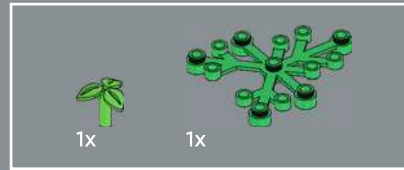

120

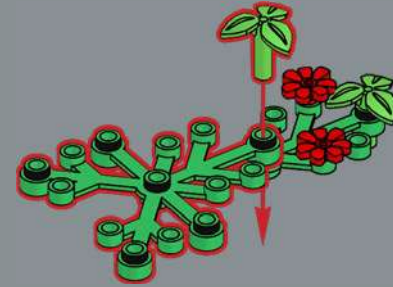

121

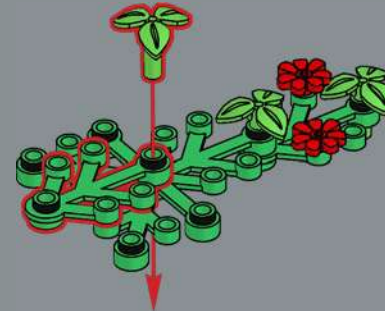



7x

122

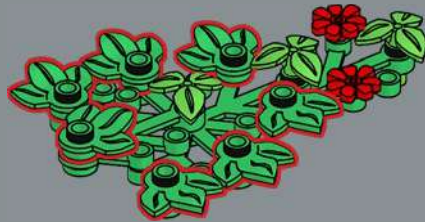

Red hibiscus flower (*Hibiscus rosa-sinensis*)  
Hibiscus flowers can be used to test the acidity of a liquid.  
A hibiscus flower will turn dark pink in acid, or green in base.  
Perfect for checking the acidity of your fountain!



7x

123

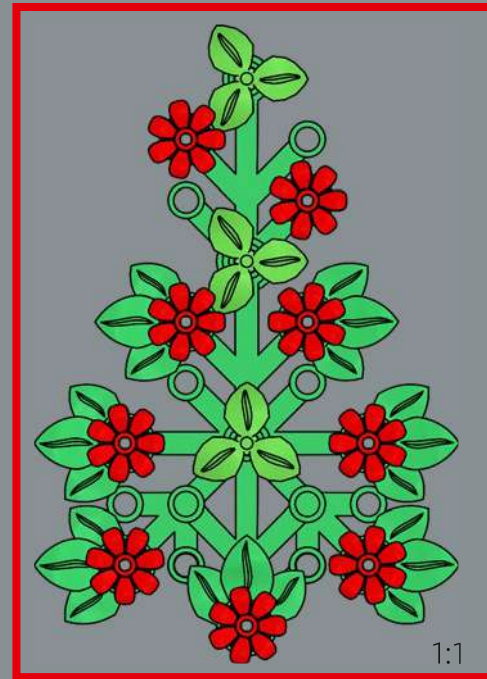
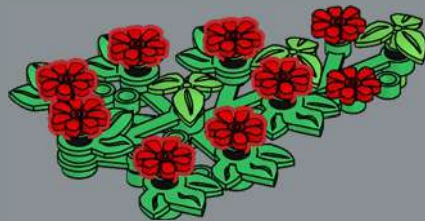





124

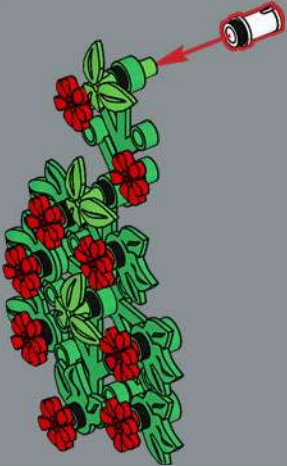

125

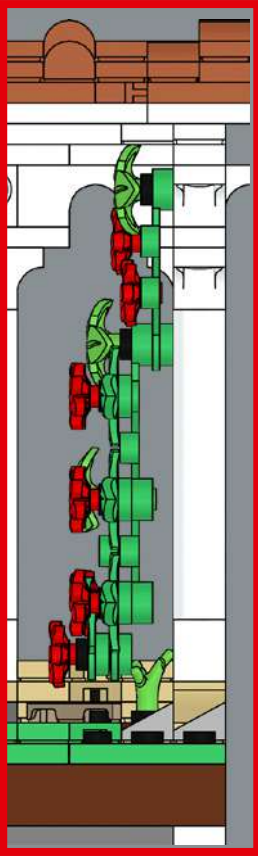

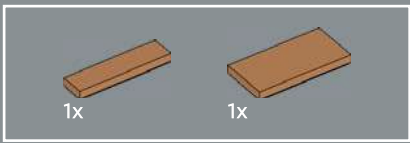

126

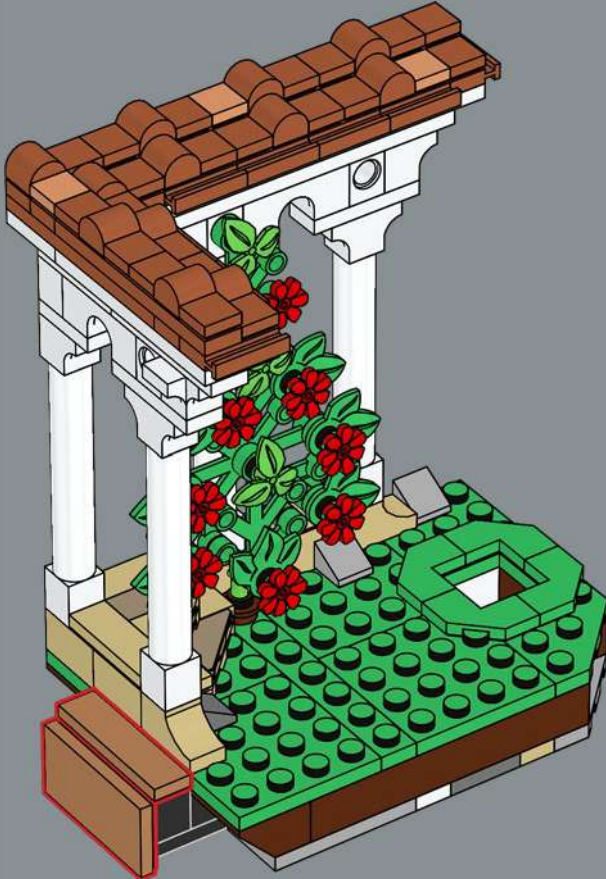

127



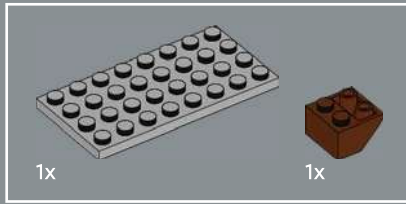
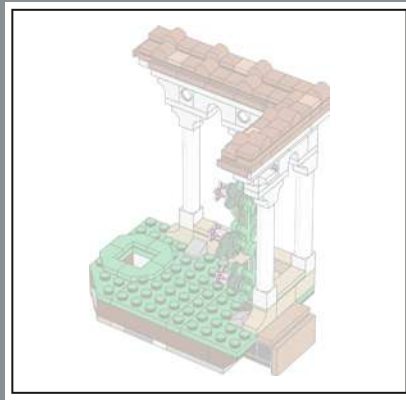

128

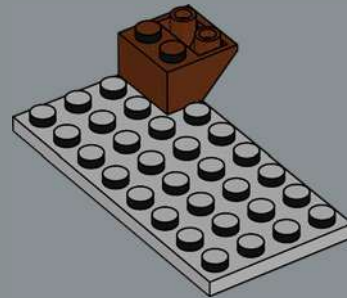

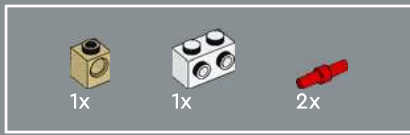

129

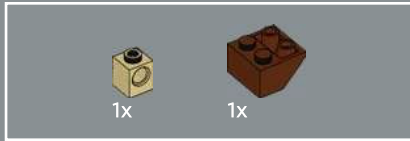
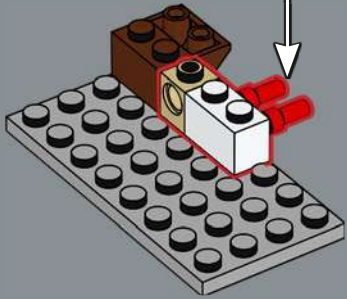
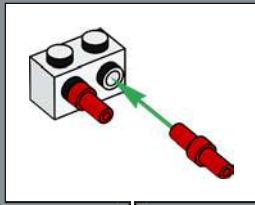

130

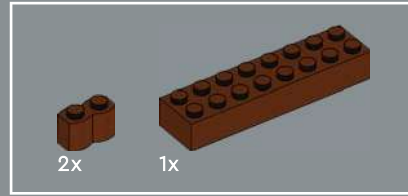
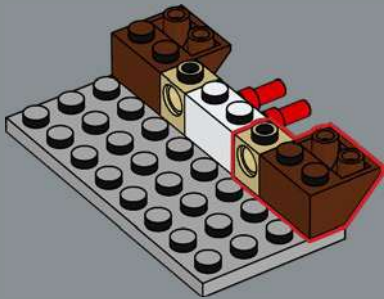

131

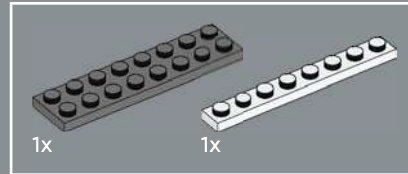
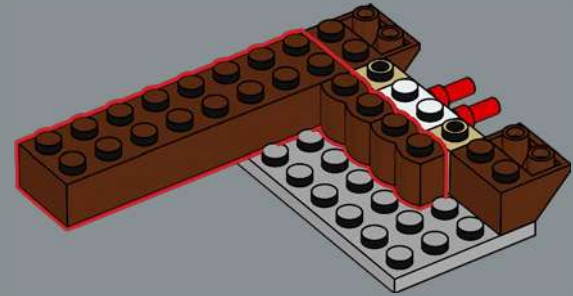

132

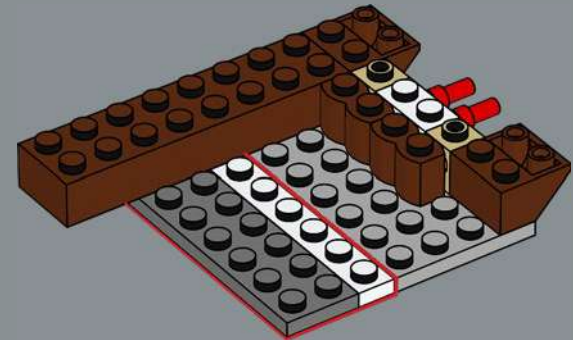

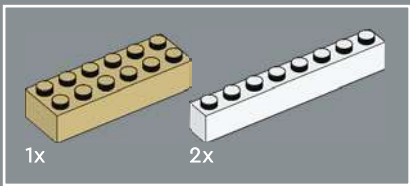

133

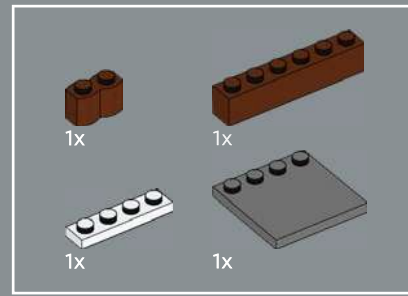
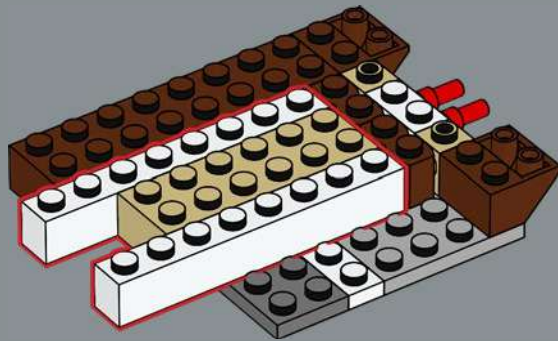

134

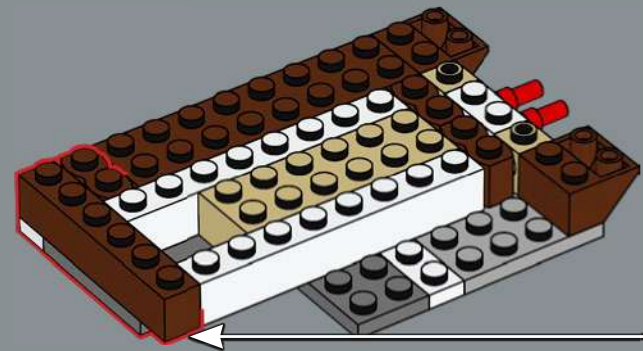
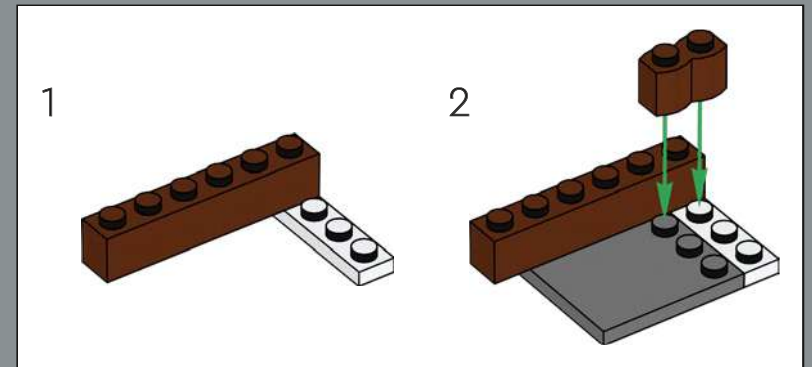

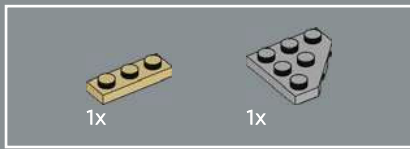

135

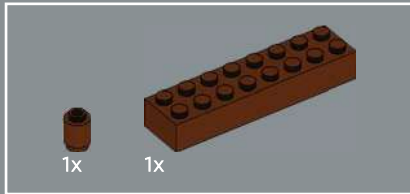
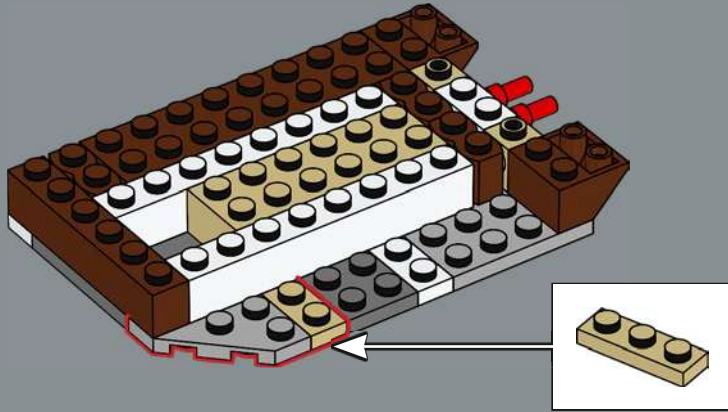

136

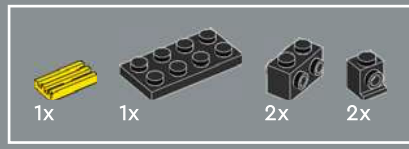
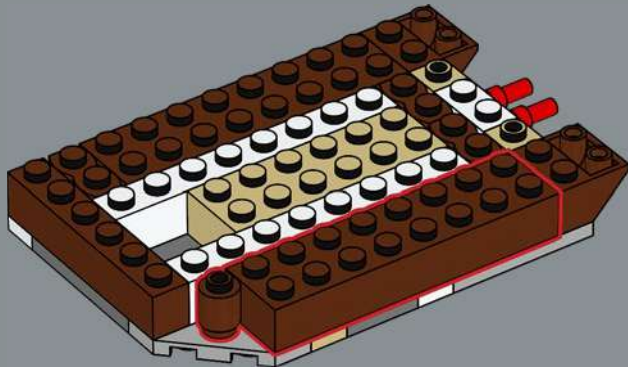

137

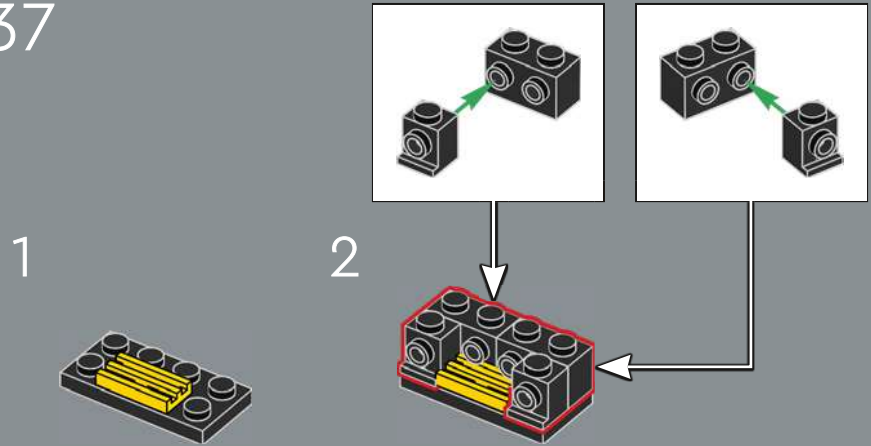

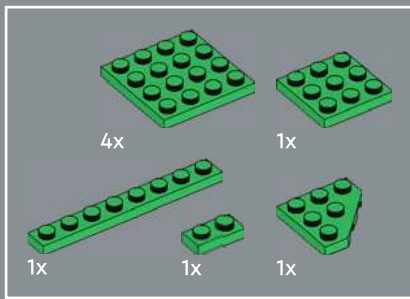

138

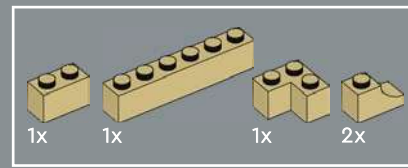

139

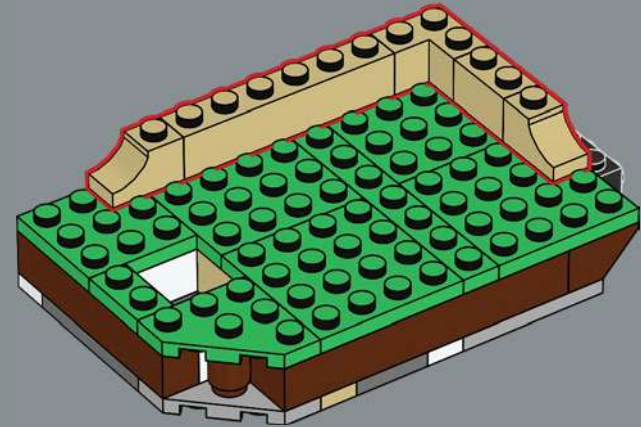



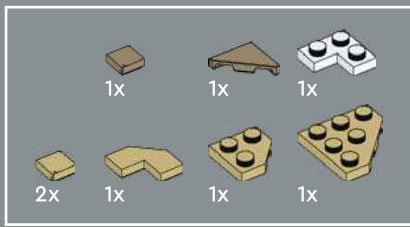

140

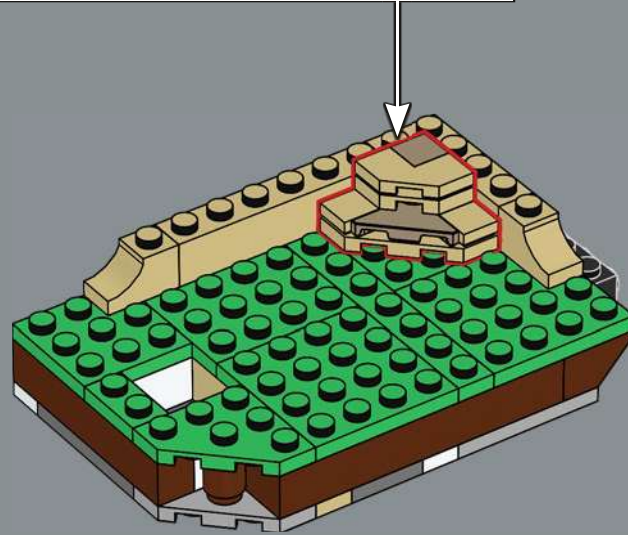
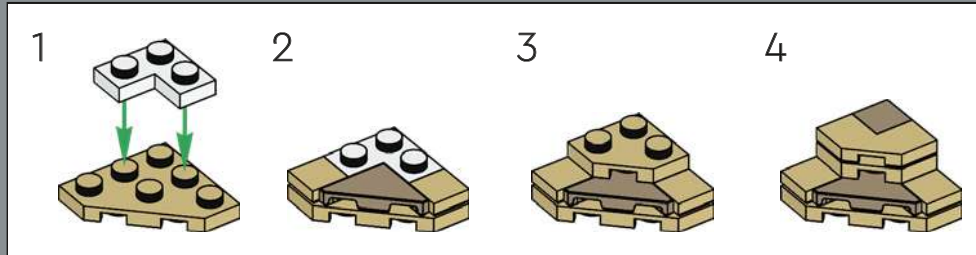



141

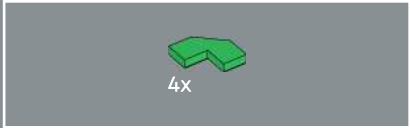
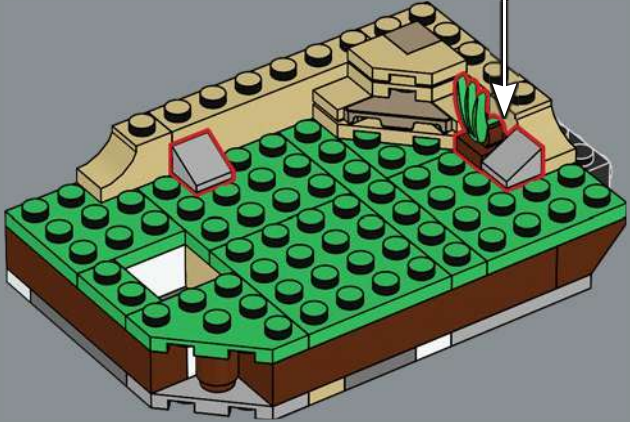
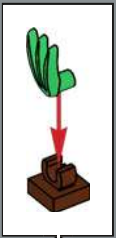

142

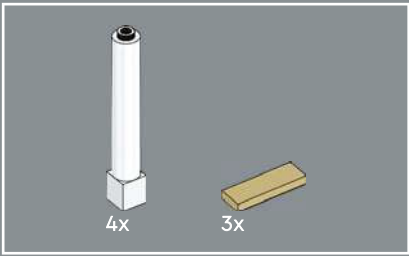
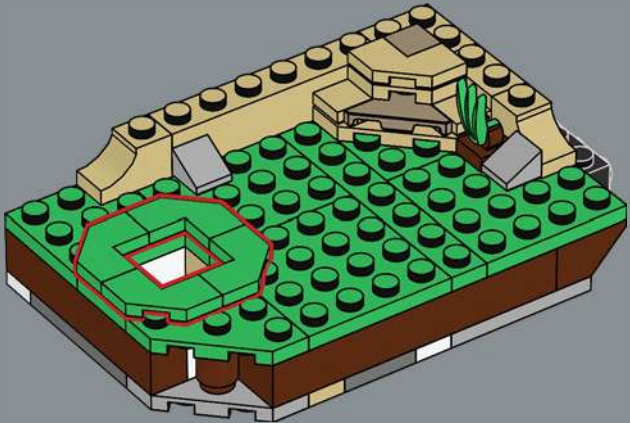

143

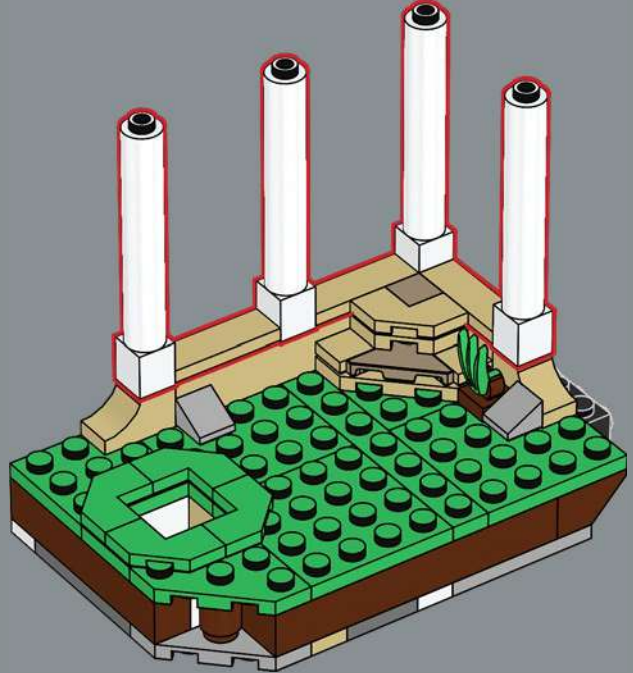

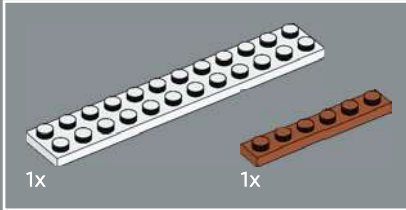
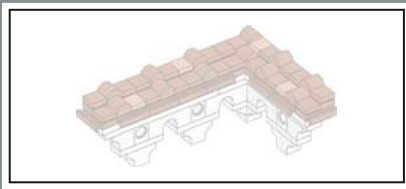

144

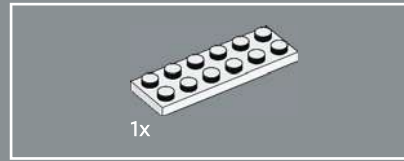
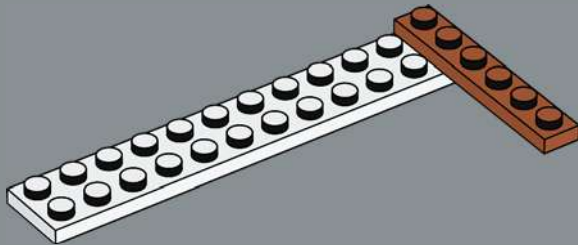

145

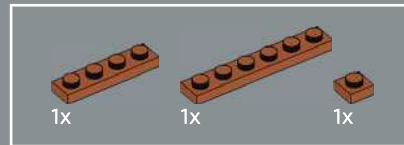
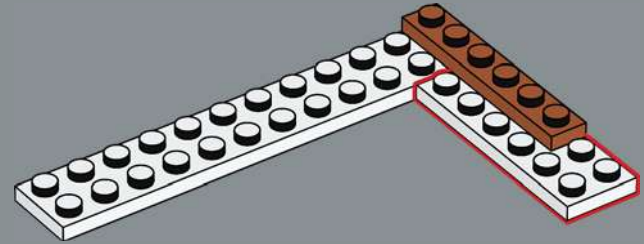

146

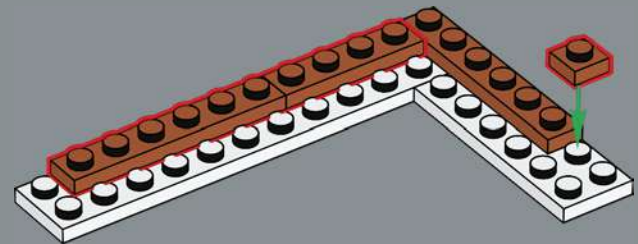



147

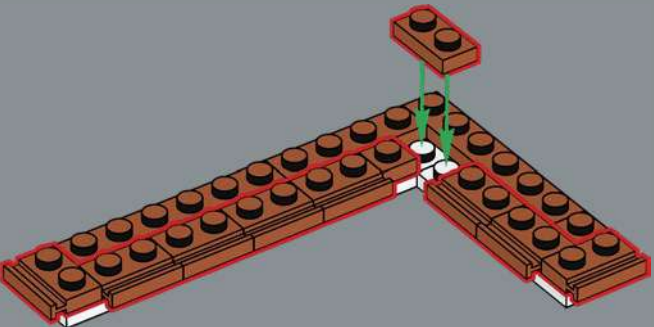

149

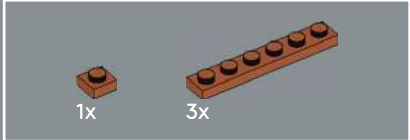
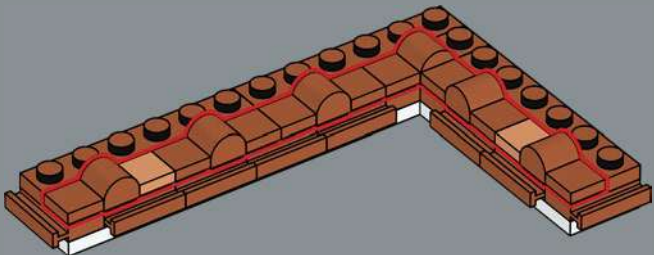

148

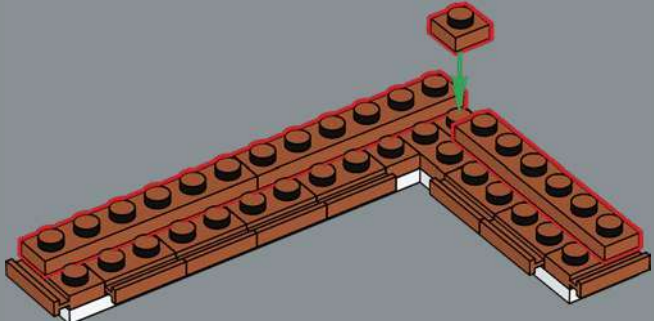

150

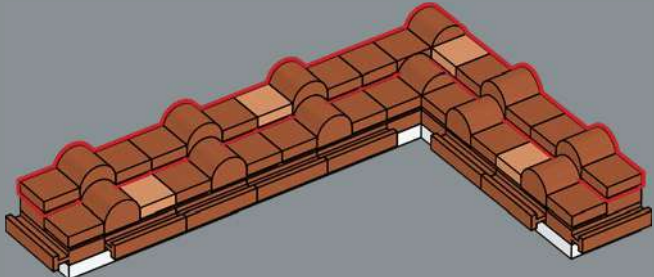

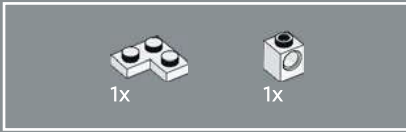
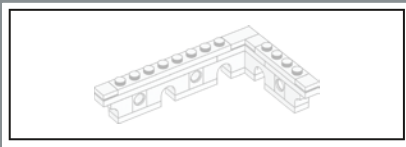

151

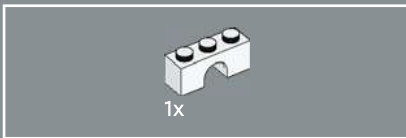
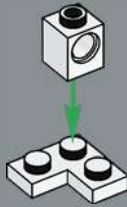

152

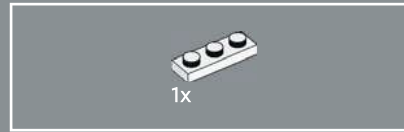
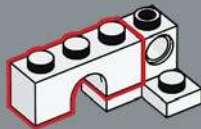

153

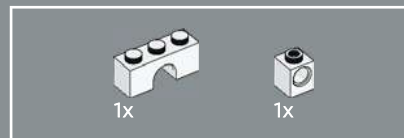
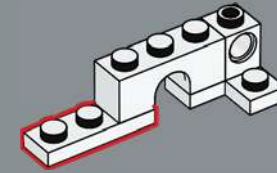

154

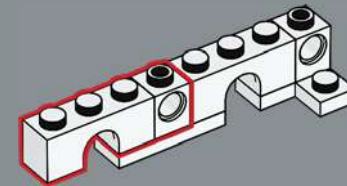

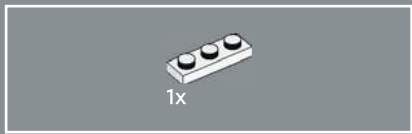

155

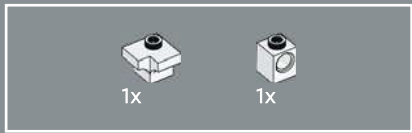
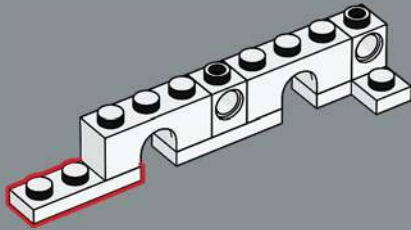

156

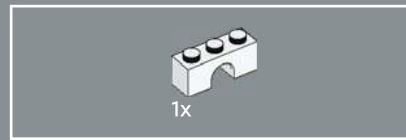
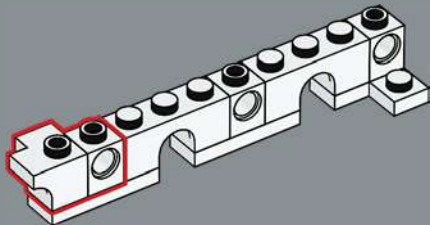

157

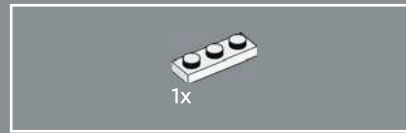
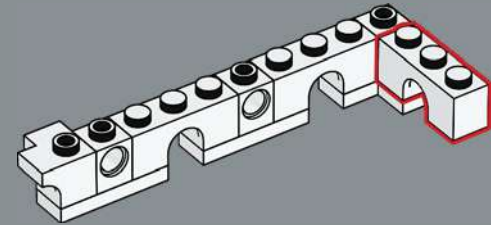

158

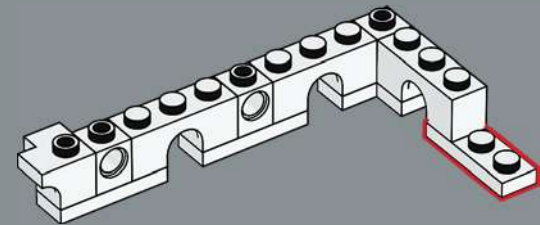

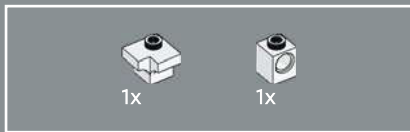

159

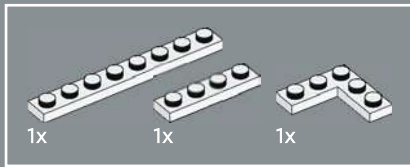
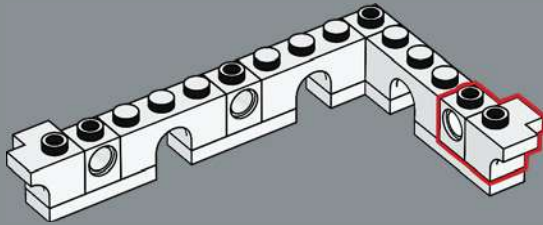

160

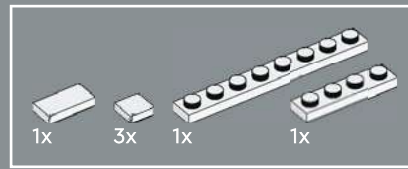
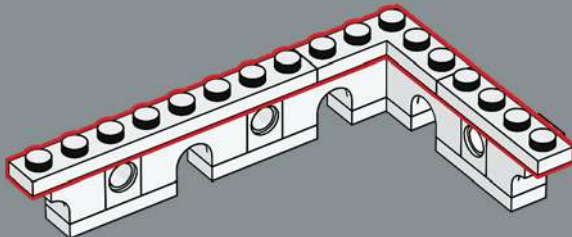

161

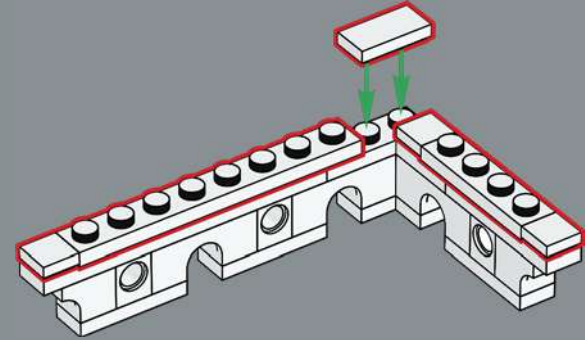

162

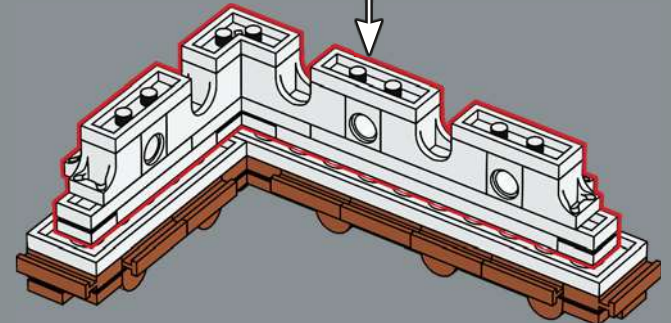

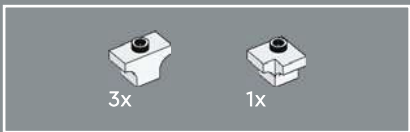

163

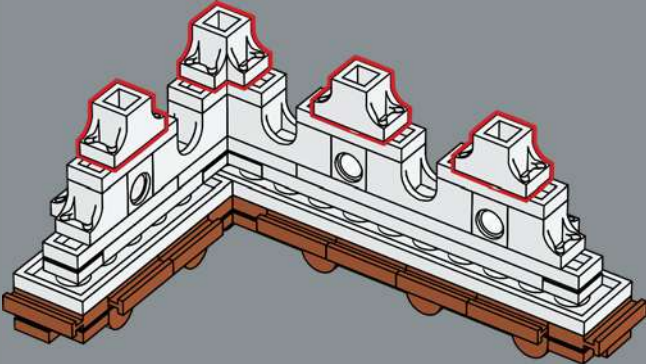

164

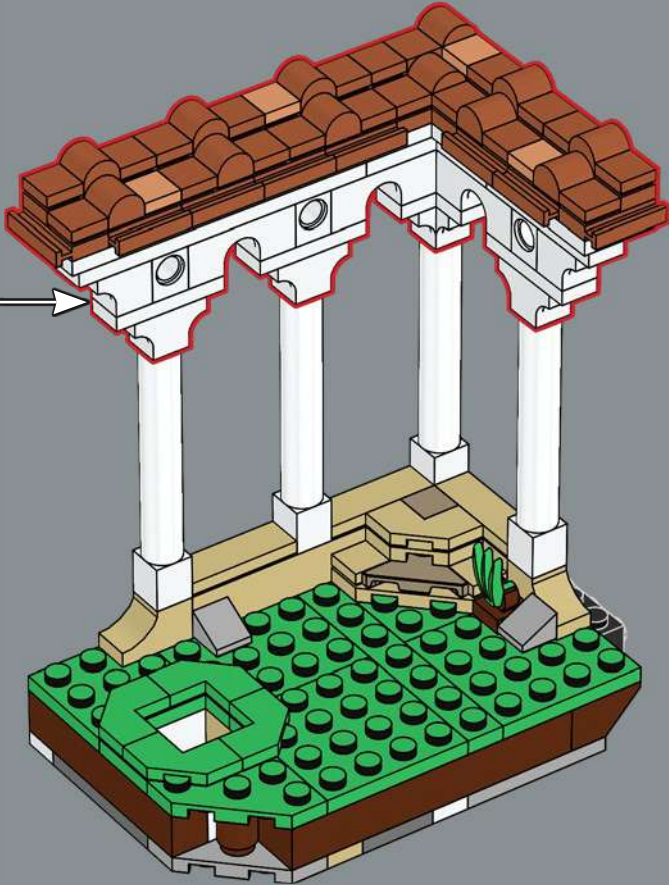



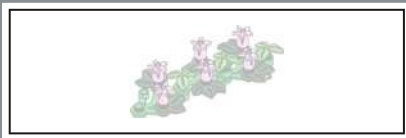

165

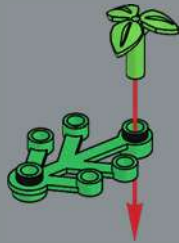

166

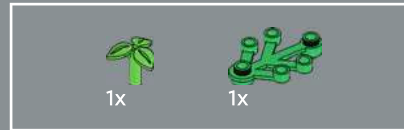
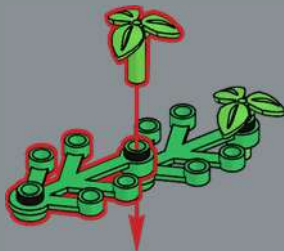

167

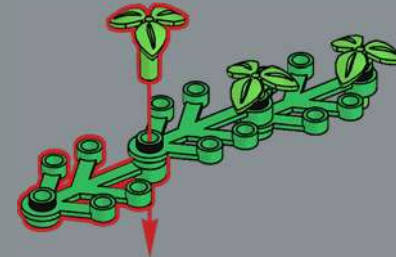

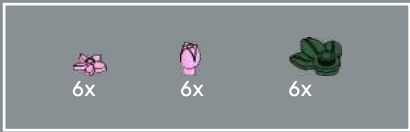

168

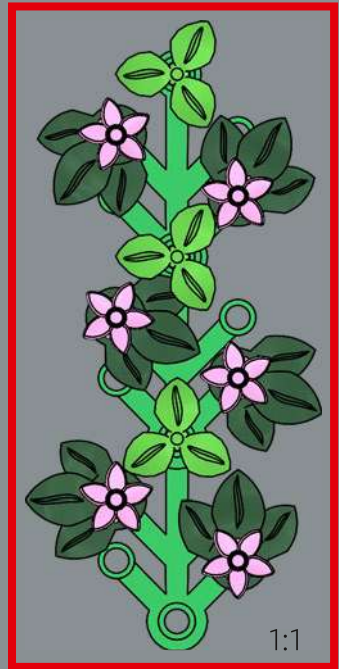
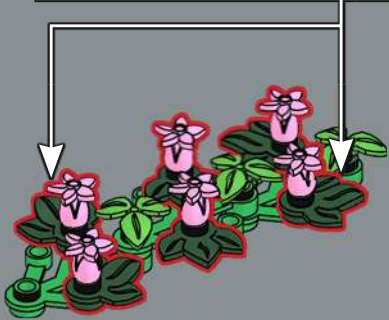
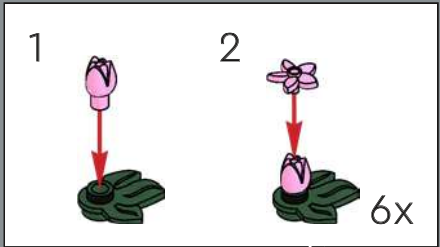

169

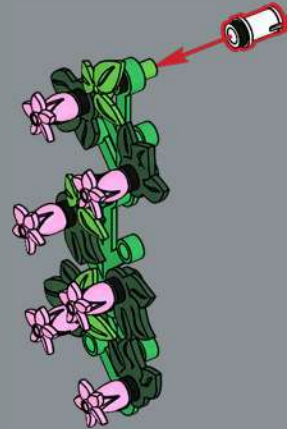

Pink bougainvillea flower (*Bougainvillea*)  
 What most people think of as the 'flower' of bougainvillea are actually bracts or 'false flowers', which are a different type of leaf surrounding the real, tiny flowers on the plant.

170

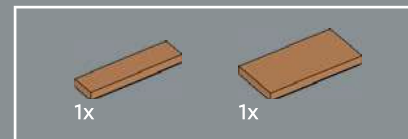
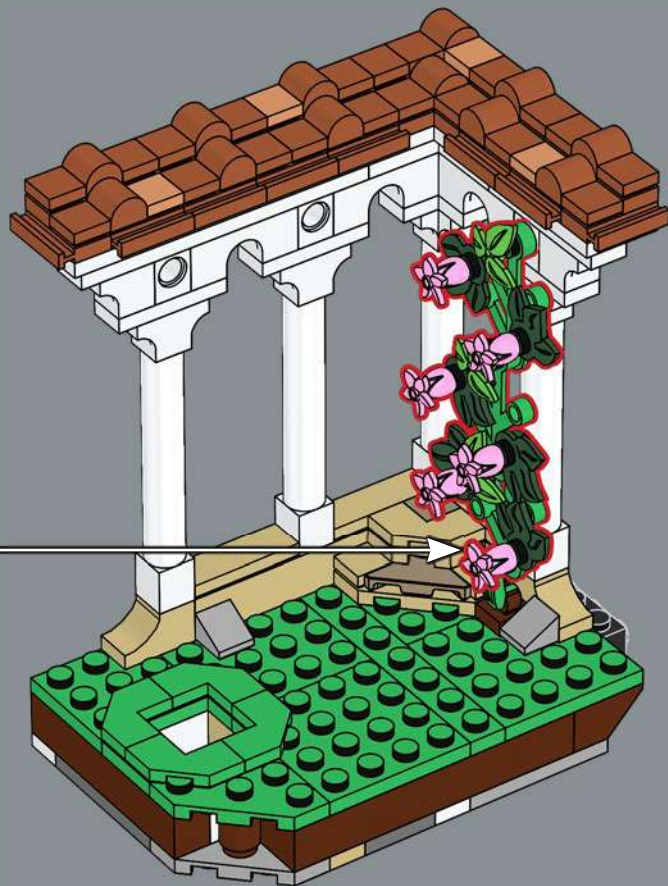

171





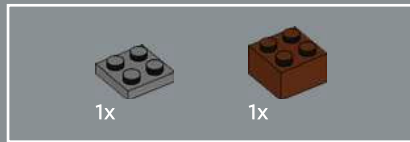
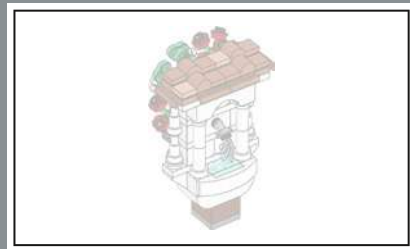

173

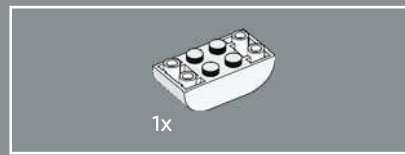
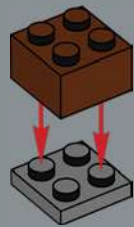

174

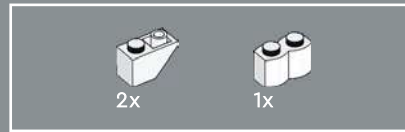
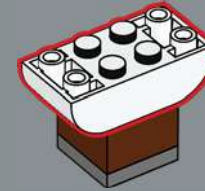

175

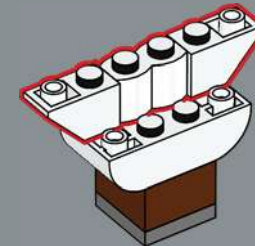

176

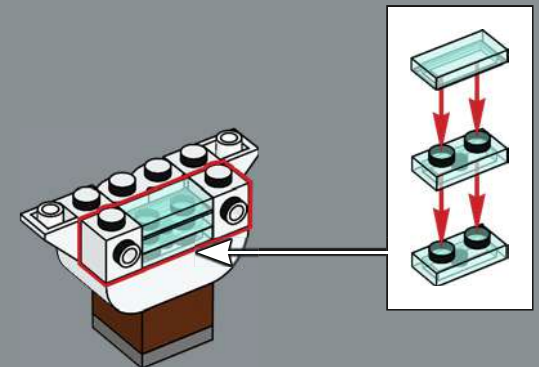



177

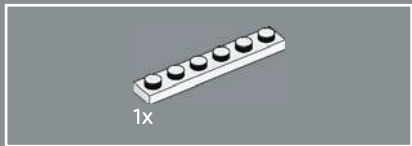
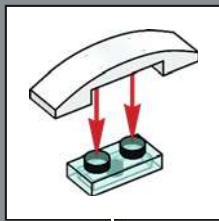

178

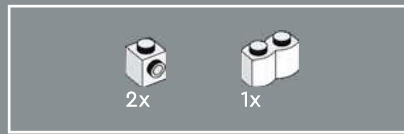

179

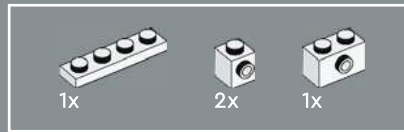
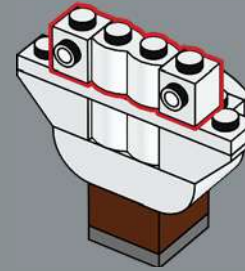

180

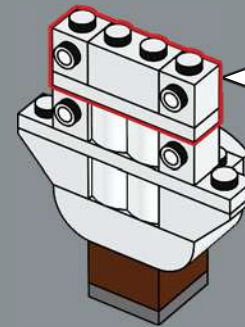
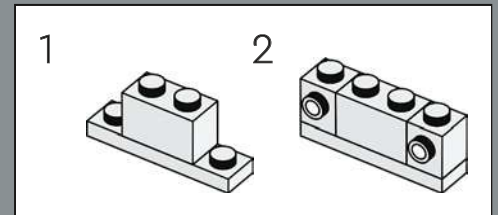

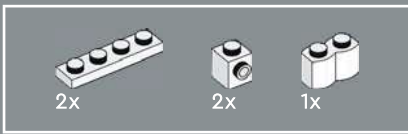

181

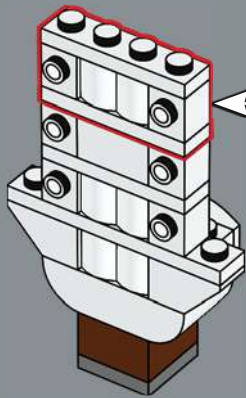
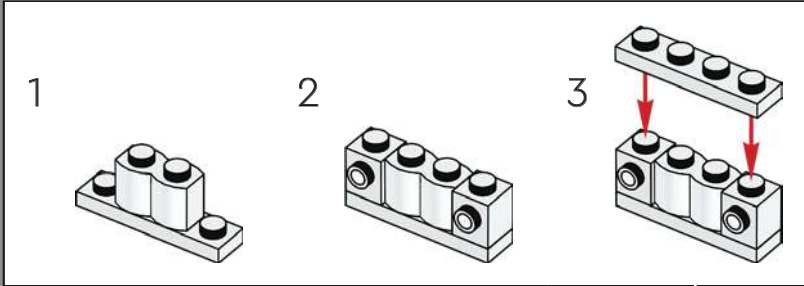

182

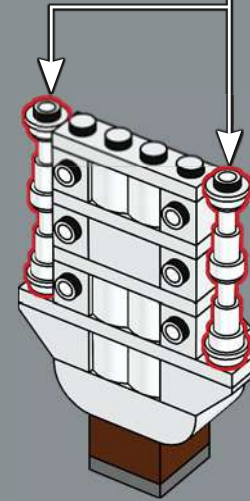
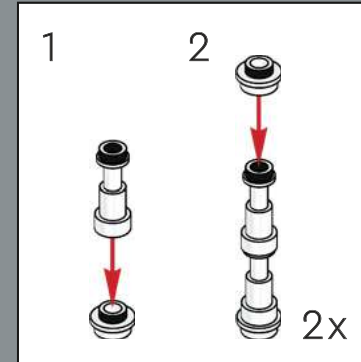



183

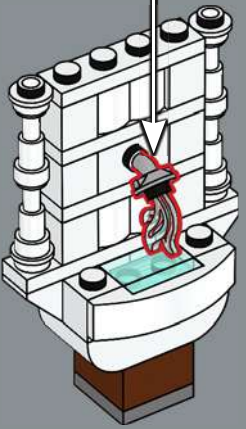

184

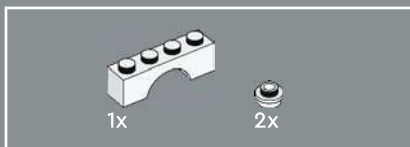
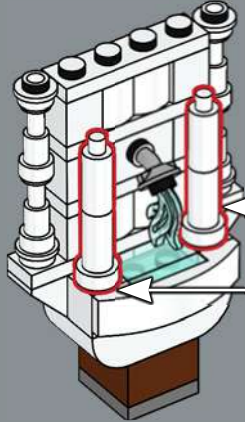
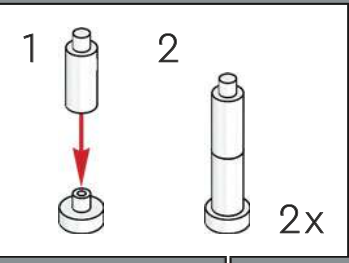

185

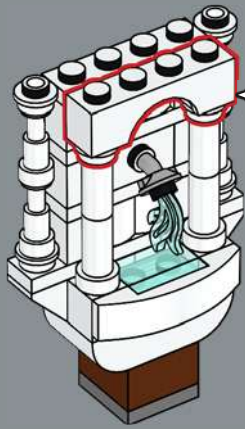
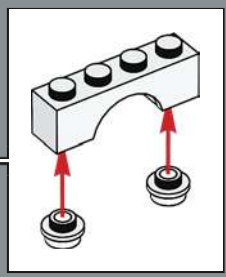



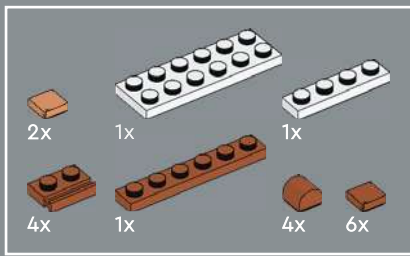

186

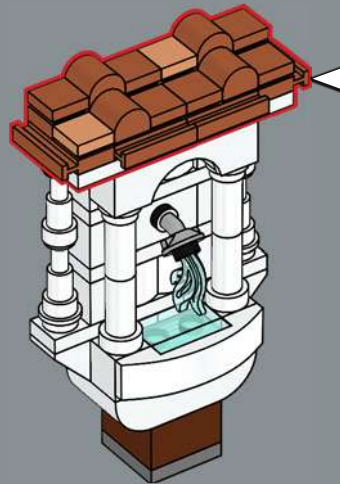
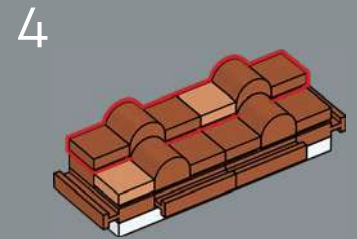
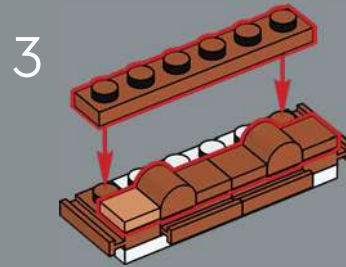
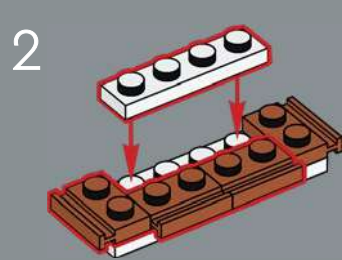
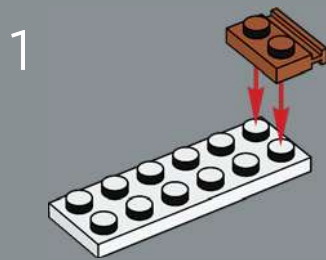



2x

187

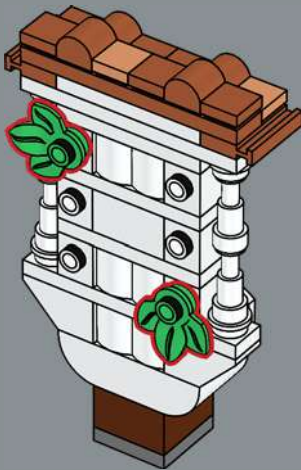

2x

188

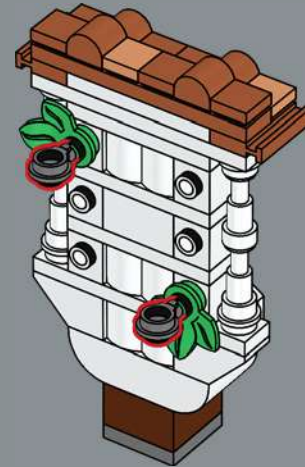



White petunia (*Petunia axillaris*)  
 Although some petunia species can be used as a garnish,  
 perhaps it's better to leave this beauty to blossom in  
 your garden. It is closely related not only to potatoes and  
 tomatoes, but also to deadly nightshade!

189

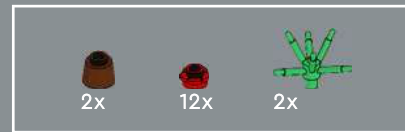
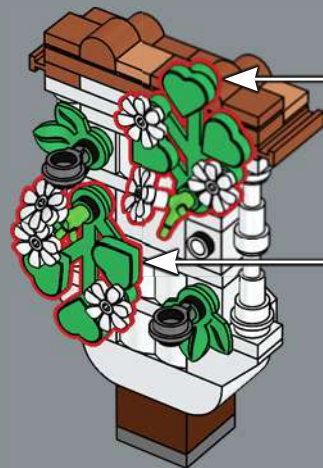
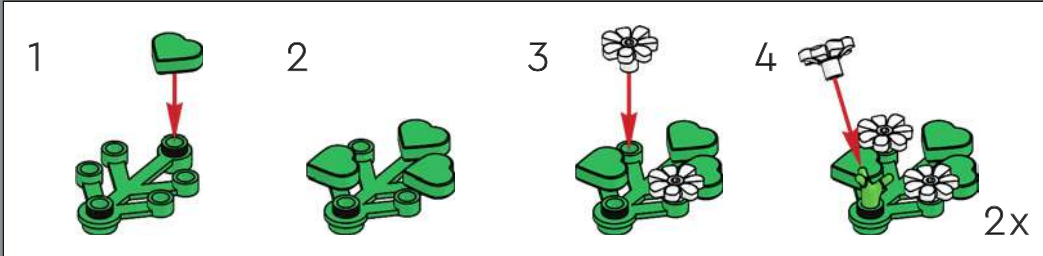

190

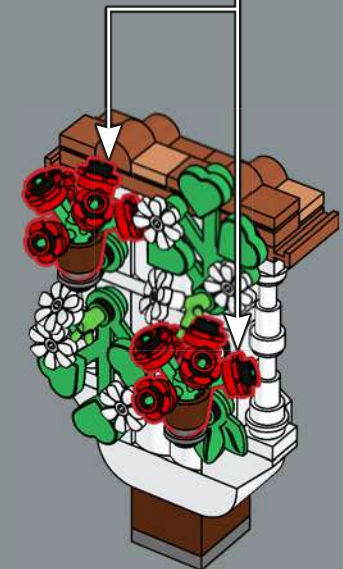
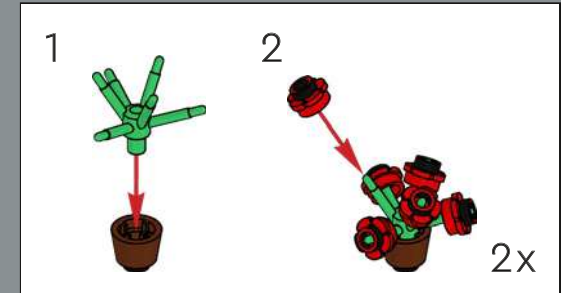

Red garden geranium (*Pelargonium x hortorum*)  
 The fragrant garden geranium serves both aesthetic and practical purposes in  
 a serene garden. Its natural oils give off a scent that sends insects packing!



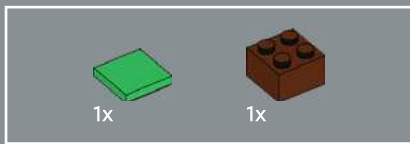

192

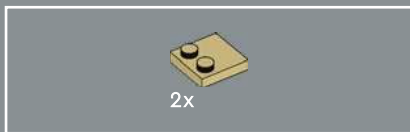
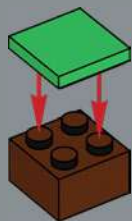

193

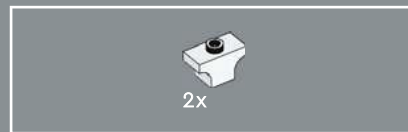
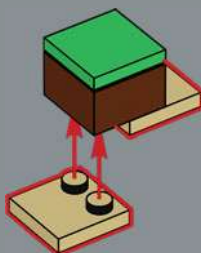

194

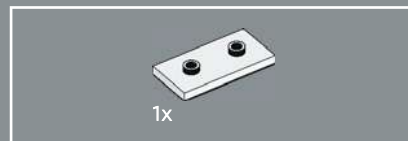
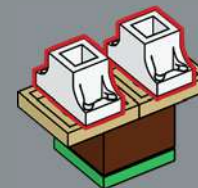

195

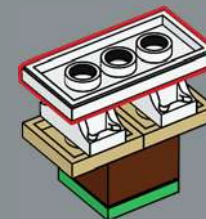

196





Iberian waterfrog (*Pelophylax perezi*)  
Native to the Iberian Peninsula, this swift little swimmer  
thrives in freshwater habitats and wetlands.

197





Yellowhammer (*Emberiza citrinella*)  
The yellowhammer, with its characteristic  
bright yellow plumage and distinctive song,  
is found throughout Europe.

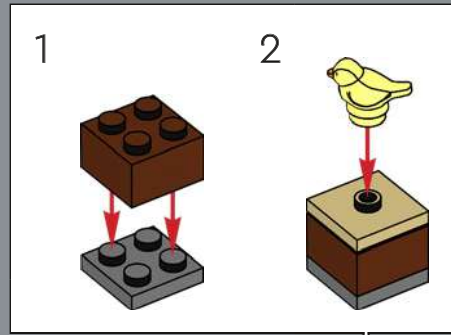
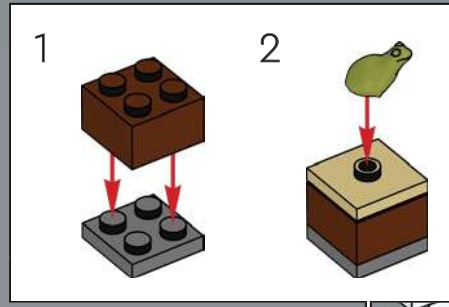
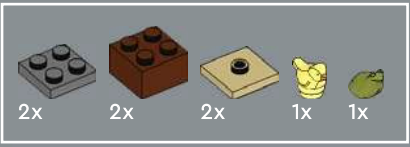

198

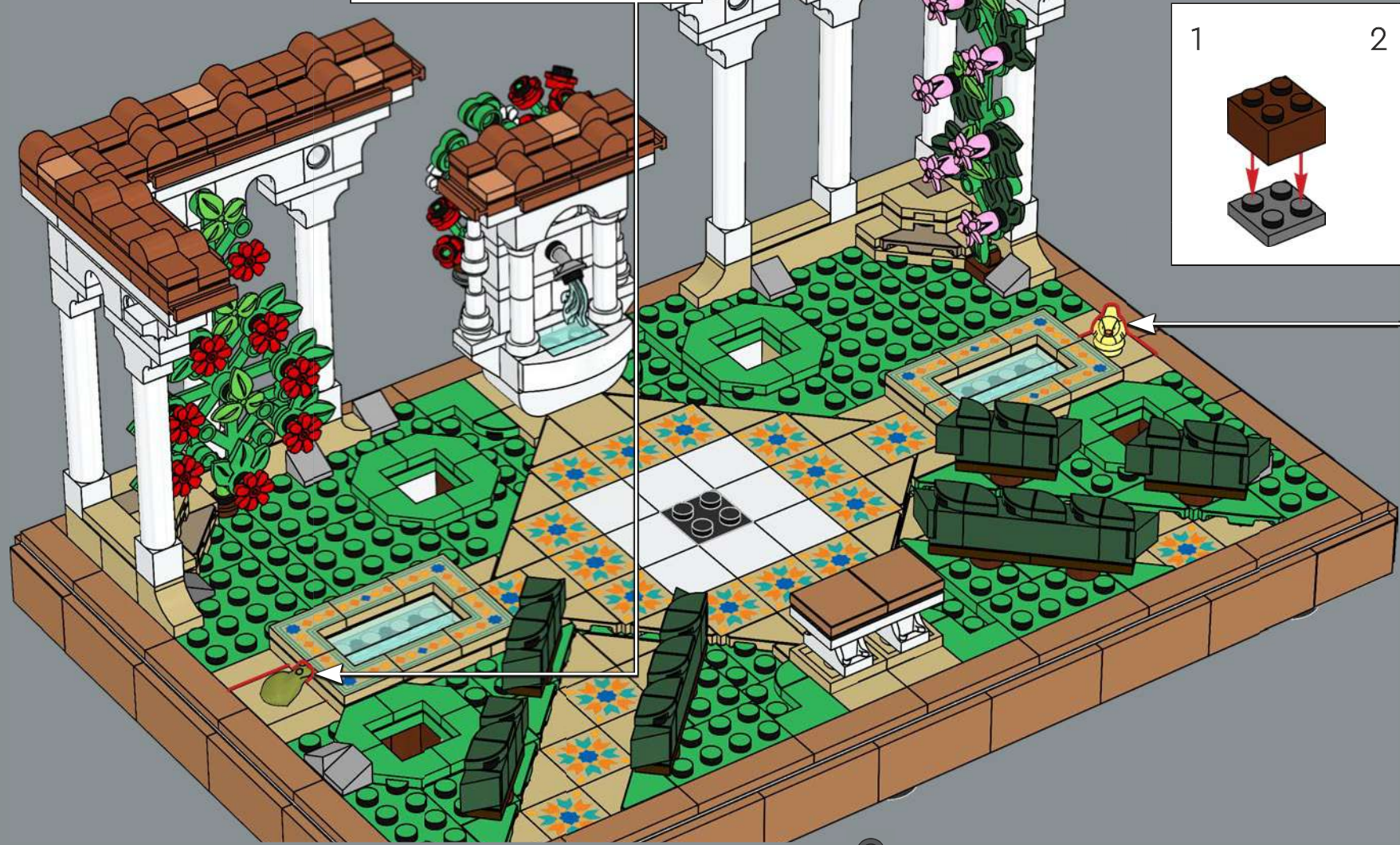

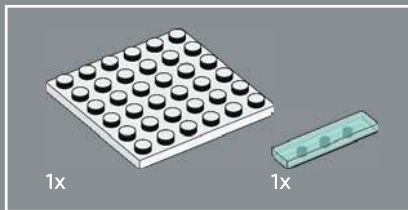
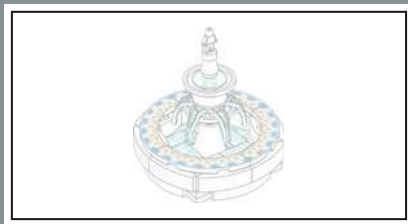

199

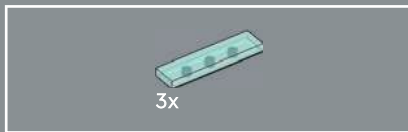

200

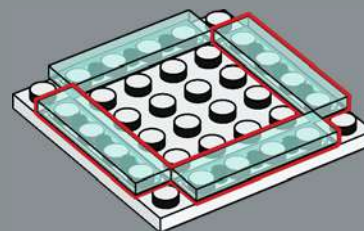





201

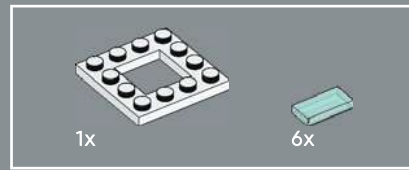
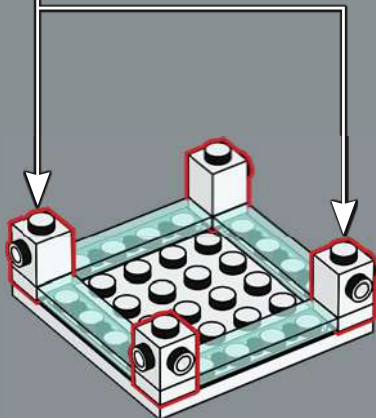
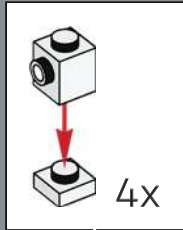

202

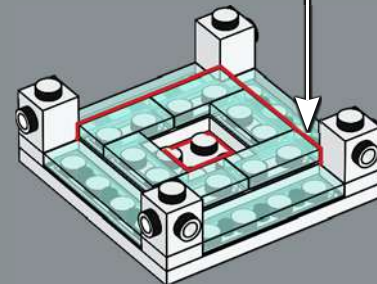
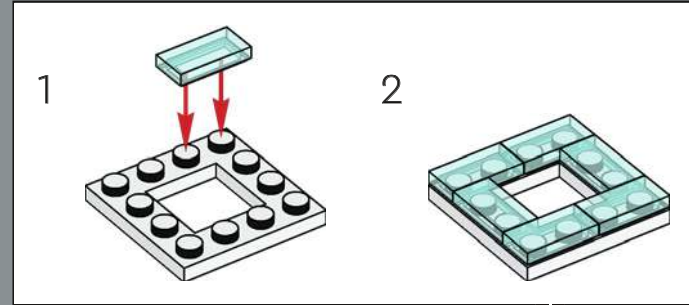

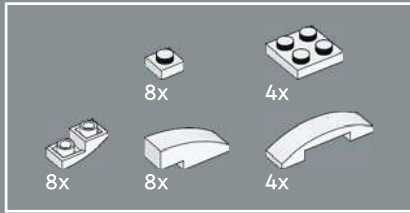
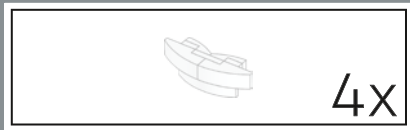

203

1

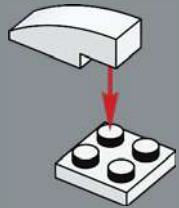

2

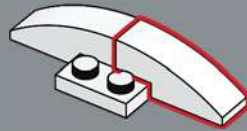

3

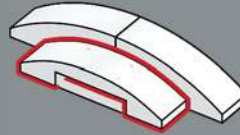

4

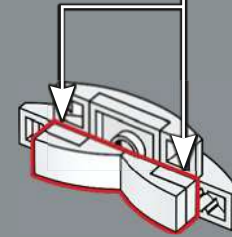
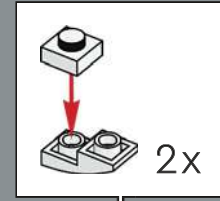

4x



204

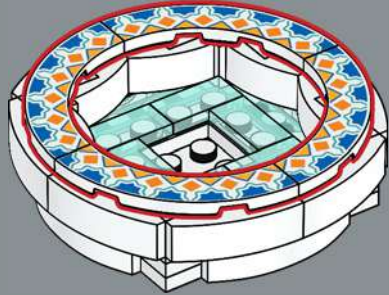
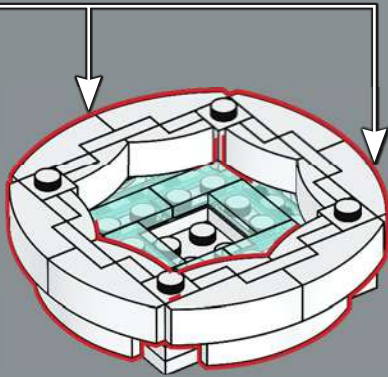

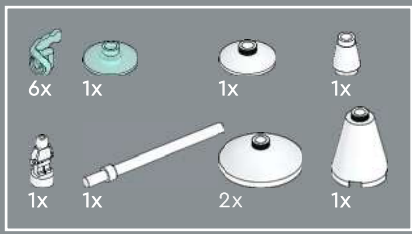

205

1

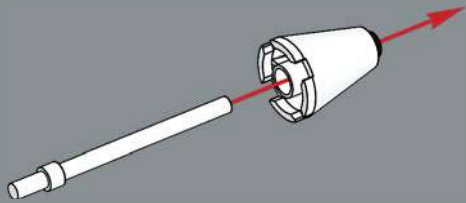

2



3



4



5

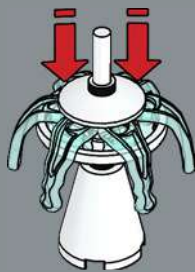

6



7

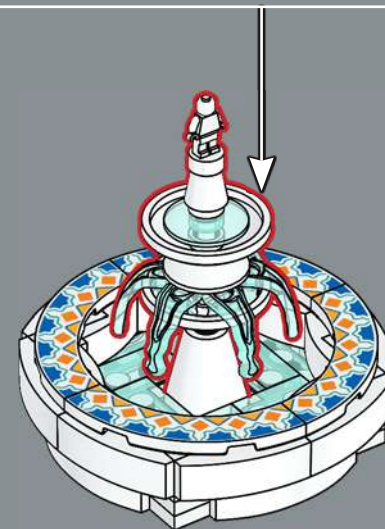



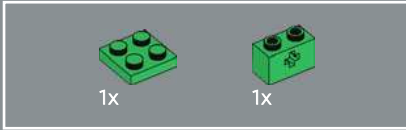

207

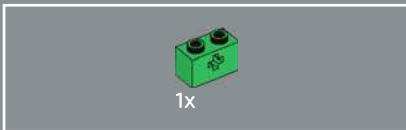
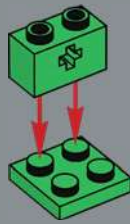

208

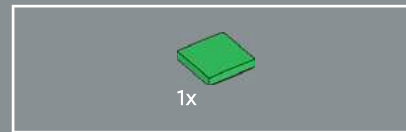
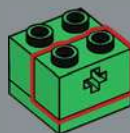

209

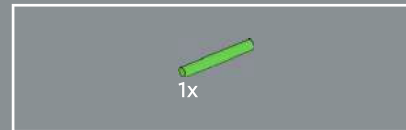
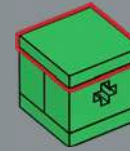

210

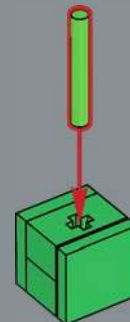

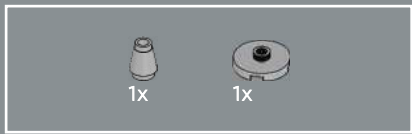

211

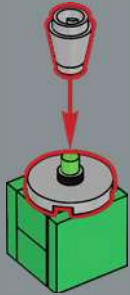

212

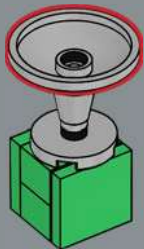

213

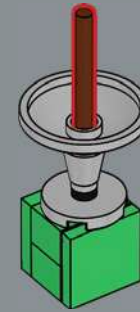





214

1

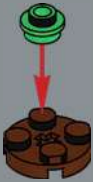

2

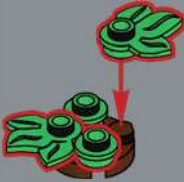

3



4

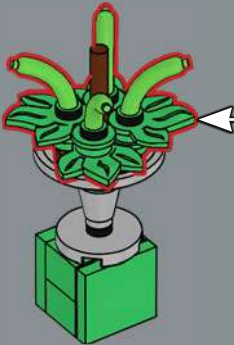

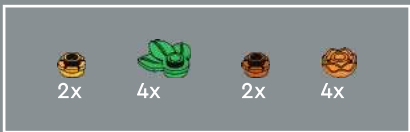

215

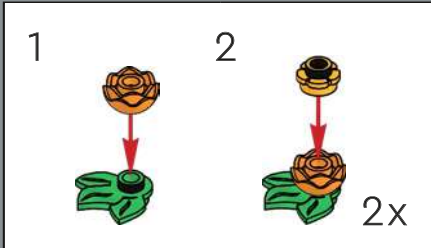
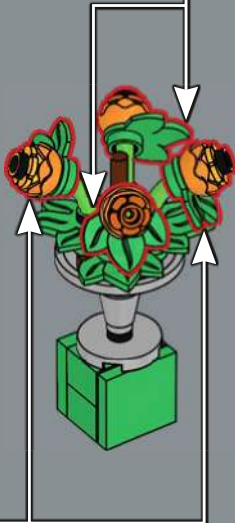
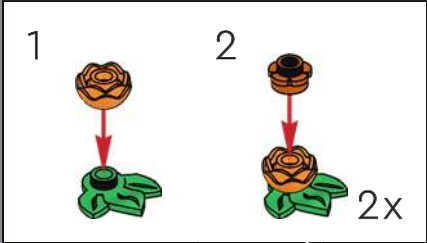

216

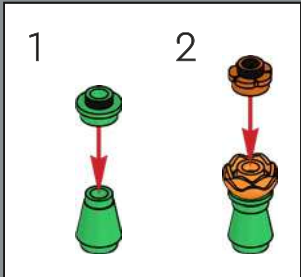

Spanish moon moth (*Graellsia isabellae*)  
 The Spanish moon moth, a stunning species with green wings and unique eyespots, thrives in the Pyrenees. A 'relic' species, it has remained largely unchanged since the last Ice Age.



217

French marigold (*Tagetes patula*)  
Marigolds originate from Central America, but these aromatic little rays of sunshine are loved by gardeners and chefs around the world as decoration or a tangy twist to sweet deserts.



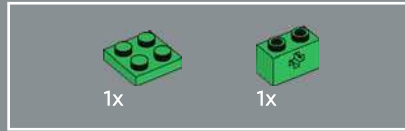
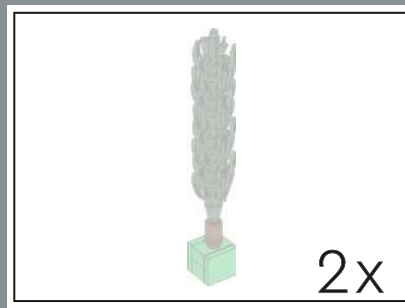

218

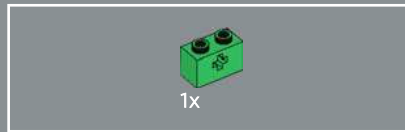
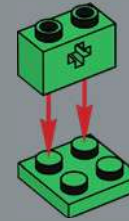

219

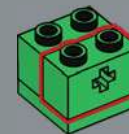

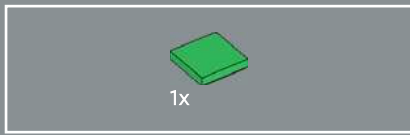

220

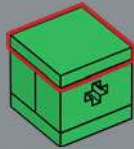

221

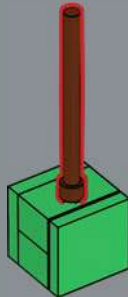

222

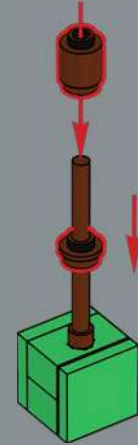

223

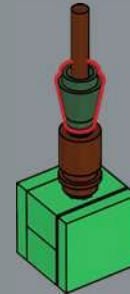

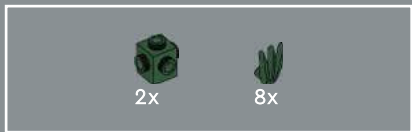

224

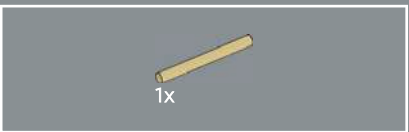
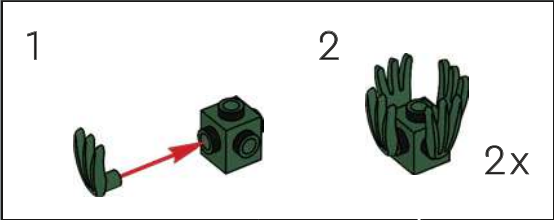

225





226

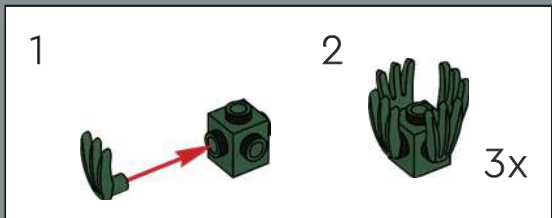

227





228

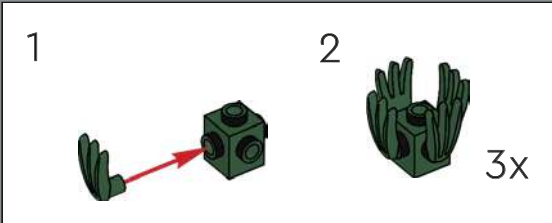

229



*Cypress (Cupressus sempervirens)*  
With their distinctive shape and beauty, cypress trees are a common sight in Mediterranean landscapes. Did you know that their aromatic oil is a valuable ingredient in health remedies and beauty products?



2x



230



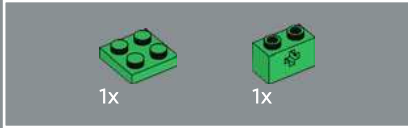
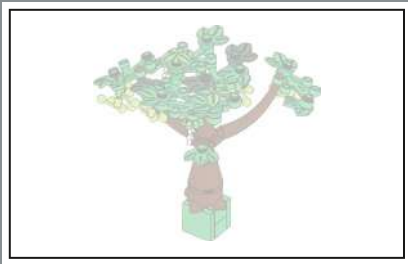

231

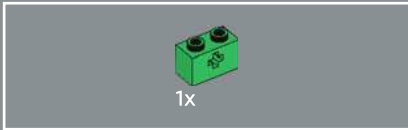
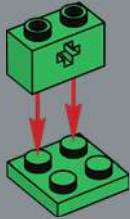

232

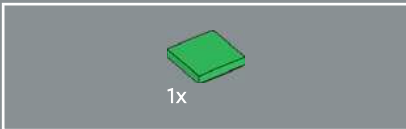

233



Grapevine (*Vitis vinifera*)  
A deliciously sweet and juicy food staple, grapes were first cultivated by ancient civilisations more than 10,000 years ago.



234



235

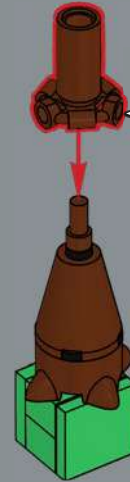
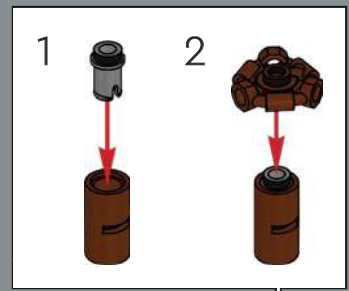

236





237

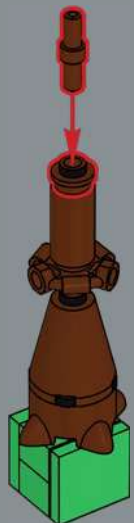

238

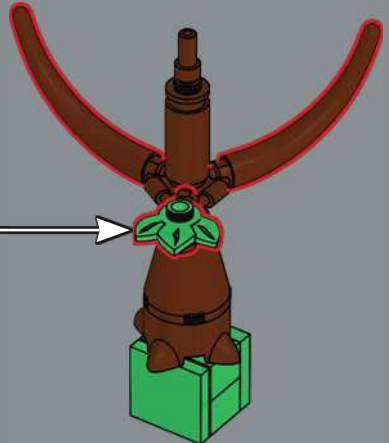
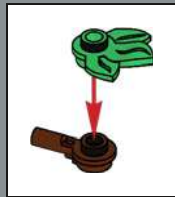

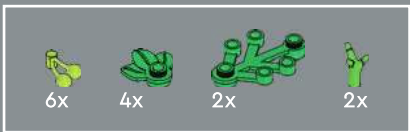

239

1

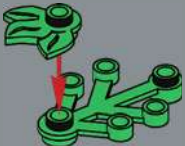

2



3

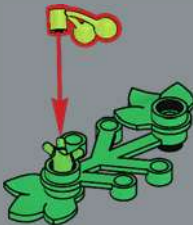

4

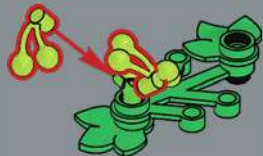

2x

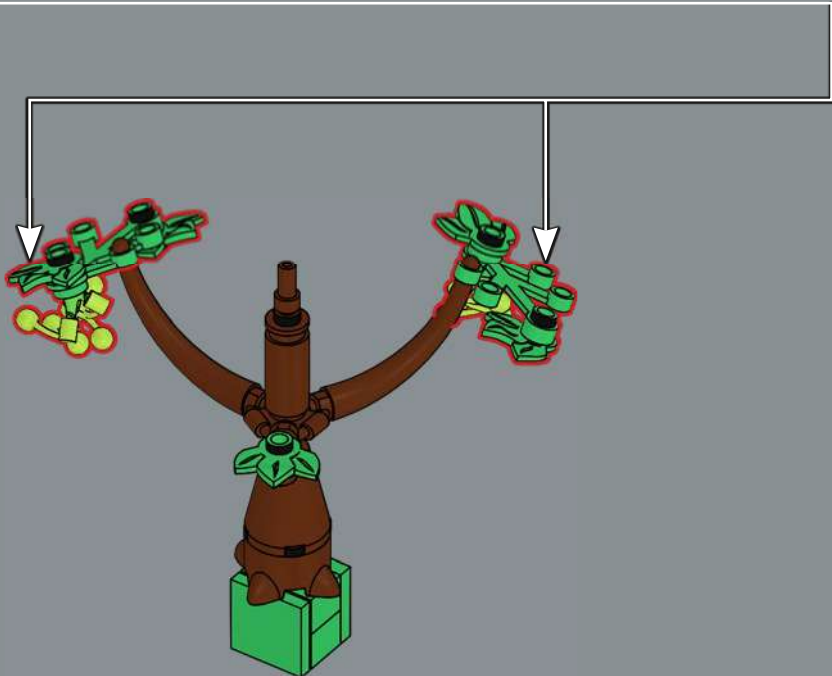

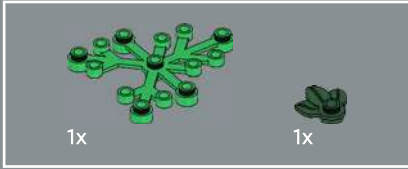

240

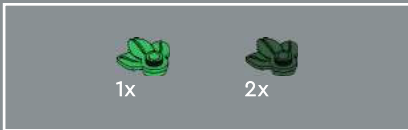
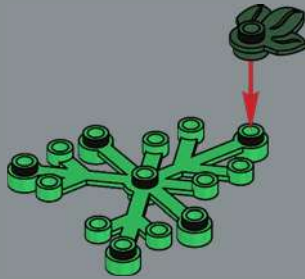

241

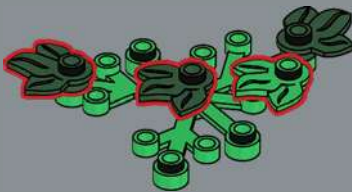

242

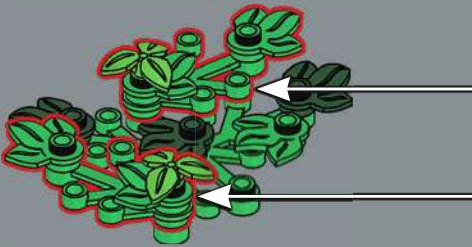
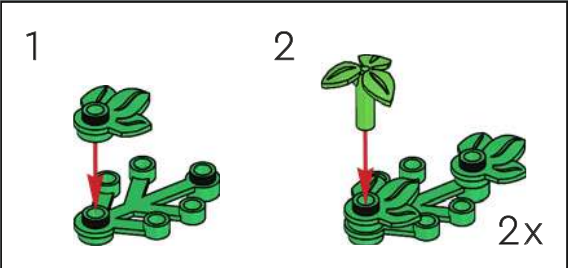

243

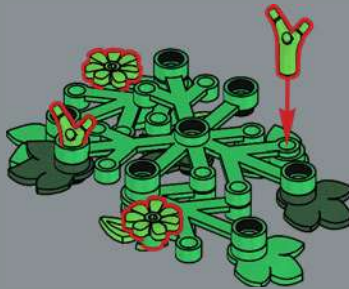



244



245

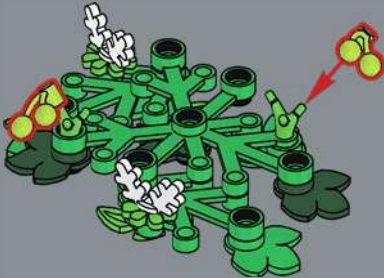

246

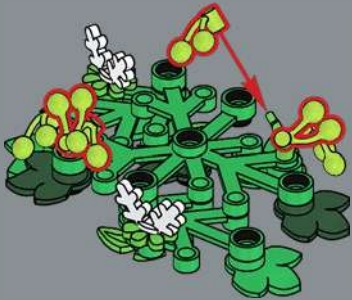

247







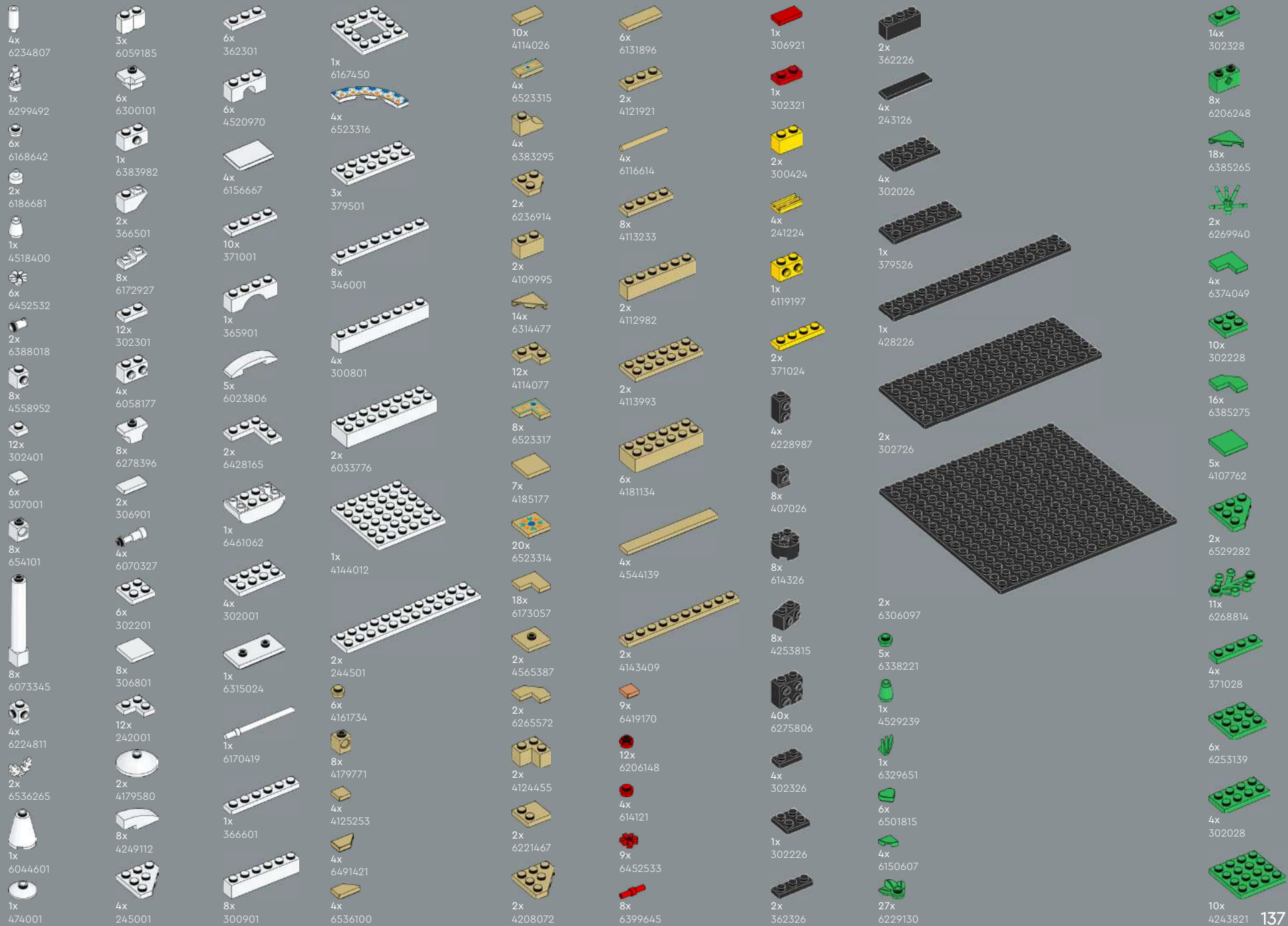



2x  
6266968

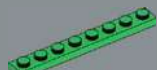

2x  
346028

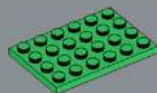

6x  
4116671

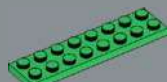

2x  
303428



7x  
6434871



2x  
6488792



4x  
6430093



8x  
6235080



1x  
6161772



[LEGO.com/service](https://www.LEGO.com/service)

47x  
6143431

28x  
6439726

6x  
6186012

2x  
4570877

20x  
6228839

2x  
6074892

11x  
6253418

6x  
6353237

1x  
6326099

1x  
6245307

3x  
6514007

7x  
6514224

8x  
6510178

5x  
6550815

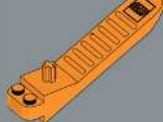

1x  
6240515

12x  
6087084

1x  
6523318

2x  
6055172

2x  
6480380

24x  
6315608

64x  
6532422

2x  
6411591

12x  
6532421

12x  
4504375

4x  
4521915

2x  
6532423

16x  
6532420

9x  
6400754

2x  
4245571

2x  
6249817

2x  
6209681

6x  
6186673

2x  
6284586

4x  
4211183

4x  
6215659

2x  
6173143

1x  
6348057

1x  
6451002

1x  
6306775

1x  
4211159

1x  
6488490

8x  
4211180

1x  
6492629

1x  
6173132

1x  
6468829

6x  
4211210

8x  
6425510

4x  
4211200

1x  
6116613

2x  
4211201

3x  
6170468

2x  
6372430

2x  
4211193

4x  
6096701

1x  
4529241

1x  
6510189

7x  
4521921

1x  
6183782

8x  
4211414

2x  
4211387

8x  
4211413

2x  
4211397

1x  
6070564

2x  
4211361

2x  
4211396

6x  
6015347

1x  
4612621

2x  
4211452

6x  
4211425

2x  
4211404

2x  
4211407

6x  
6519672

6x  
6096990

1x  
6465604

2x  
6395635

1x  
4504378

1x  
4210848

2x  
6388118

2x  
4211088

3x  
4211094

8x  
4624186

4x  
4210897

2x  
4509911

2x  
6199511

2x  
6187438

6x  
4210997

8x  
6272145

2x  
6313601

4x  
6365746

8x  
6187006

24x  
6102998

22x  
6218359

1x  
6472547

3x  
6475523



# YOU COULD WIN



## YOU COULD WIN

Your feedback will help shape the future development of this product series.

Visit:

## DU KÖNNTEST GEWINNEN

Dein Feedback trägt zur Weiterentwicklung dieser Produktreihe bei.

Geh auf:

## VOUS POURRIEZ GAGNER

Vos commentaires nous aideront à concevoir les futurs produits de cette gamme.

Visitez :

## POTRESTI VINCERE TU

La tua opinione ci aiuterà a migliorare la creazione futura di questa linea di prodotti.

Visita:

## PUEDES GANAR

Tu opinión contribuirá al futuro de esta serie de productos.

Visita:

## 轻松获奖

您的反馈将有助于我们在今后改进本产品系列。

请访问:

---

**[LEGO.com/productfeedback](https://LEGO.com/productfeedback)**

---

You also have the chance to win a LEGO® set.

Terms and conditions apply.\*

Außerdem hast du die Chance, ein LEGO® Set zu gewinnen.

Es gelten die Teilnahmebedingungen.\*

Vous pourriez également gagner un ensemble LEGO®.

Des conditions s'appliquent.\*

Hai anche la possibilità di vincere un set LEGO®.

Termini e condizioni sono applicabili.\*

También tienes la oportunidad de ganar un set LEGO®.

Aplican términos y condiciones.\*

您还有机会赢取乐高®套装。

条款和条件适用。\*

\*[LEGO.com/productfeedback-terms](https://LEGO.com/productfeedback-terms)



LEGO and the LEGO logo are trademarks of the LEGO Group. ©2025 The LEGO Group.

6553150