



Disney

43268



LEGO® Builder



LEGO.com/sustainable-packaging



FR

DONNEZ
OU
RECYCLEZ



OU



OU



ASSOCIATION MAGASIN DÉCHÈTERIE

Adresses sur quefairedemesdechets.fr



 **LEGO® Builder**

BUILDER



Apple and the Apple logo are trademarks of Apple Inc., registered in the U.S. and other countries and regions. App Store is a service mark of Apple Inc. Google Play and the Google Play logo are trademarks of Google LLC. Tencent and the Tencent logo are trademarks of Tencent Inc.

 LEGO.com/devicecheck

EN Ask parents' permission before going online | **DE** Eltern um Erlaubnis bitten, bevor du online gehst | **FR** Demande l'autorisation d'un parent avant d'aller en ligne | **IT** Chiedi il permesso ai tuoi genitori prima di andare online | **ES** Pídeles permiso a tus papás antes de conectarte a Internet | **PT** Pede autorização aos pais antes de acederes online | **ZH** 上网前应先征得父母的同意 | **PL** Poproś rodziców o zgodę, zanim wejdiesz do Internetu | **CS** Než půjdeš na internet, požádej rodiče o svolení | **SK** Skôr než pôjdeš na internet, vypýtaj si povolenie od rodičov | **HU** Kérj szülői engedélyt, mielőtt online csatlakoznál! | **RO** Cere permisiunea părinților înainte de a te conecta online | **BG** Поискайте разрешение от родител, преди да влезете онлайн | **LV** Pirms došanās tiešsaistē palūdz atļauju vecākiem | **ET** Enne Interneti kasutamist küsi vanematelt luba | **LT** Prieš prisijungdami prie interneto, atsiklauskite tėvų

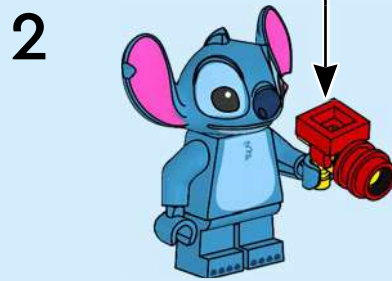
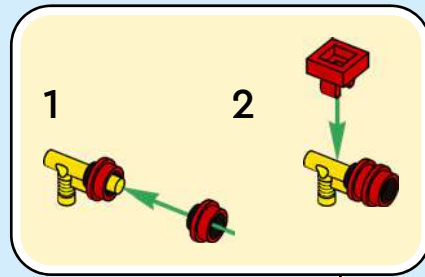
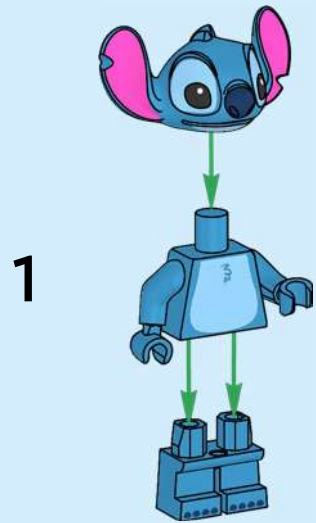

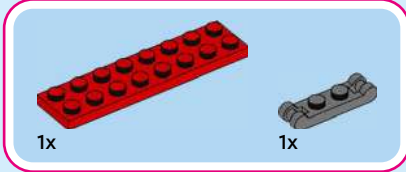

1

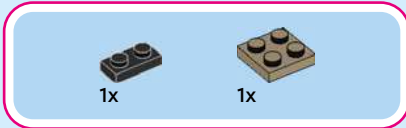
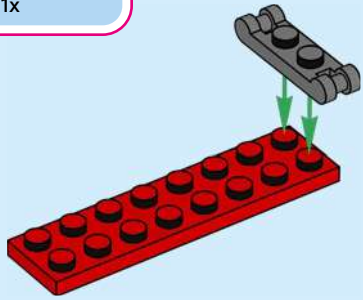

2

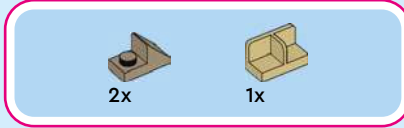
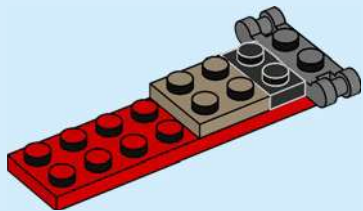

3

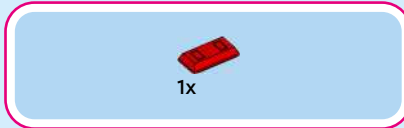
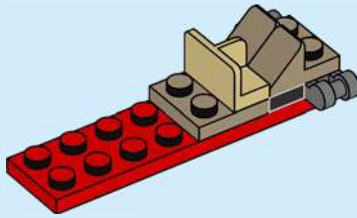

4

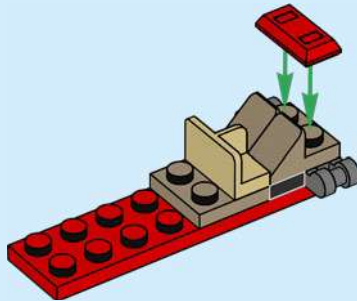



2x

5

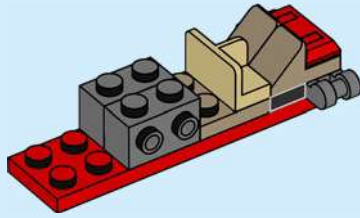

1x



1x

6

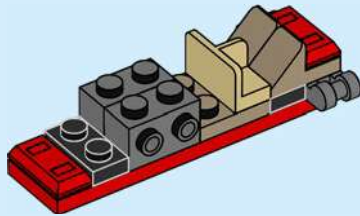

4x

7

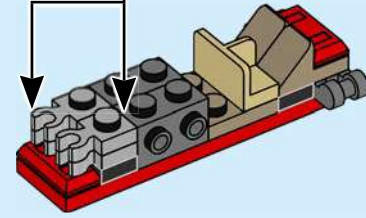
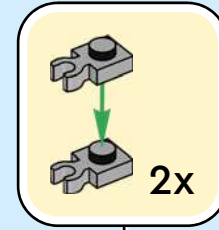

1x



1x

8

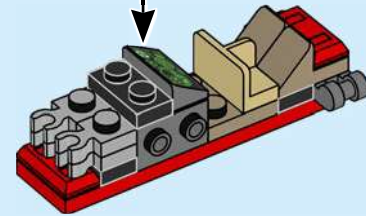

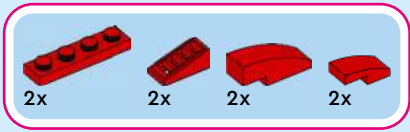

9

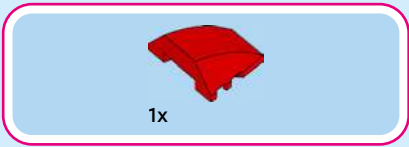
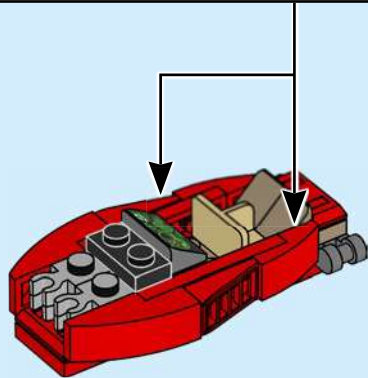
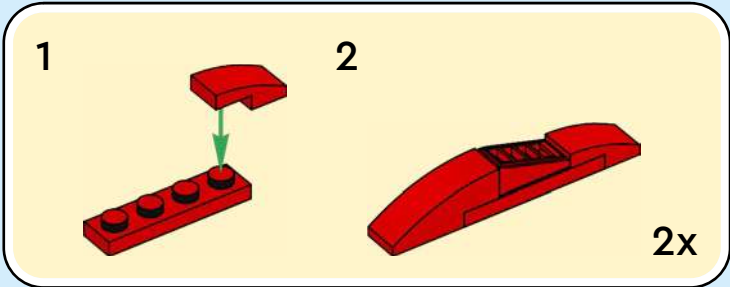

10

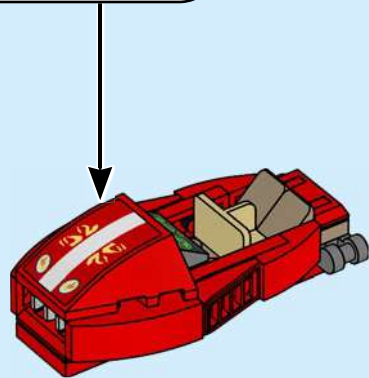
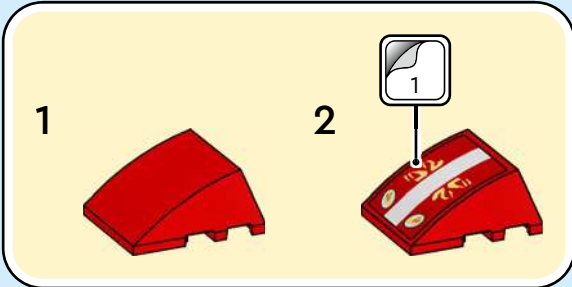

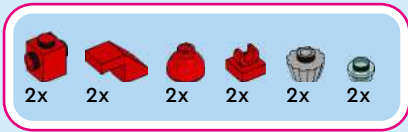

11

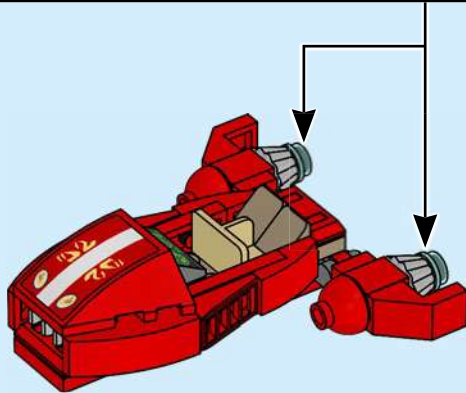
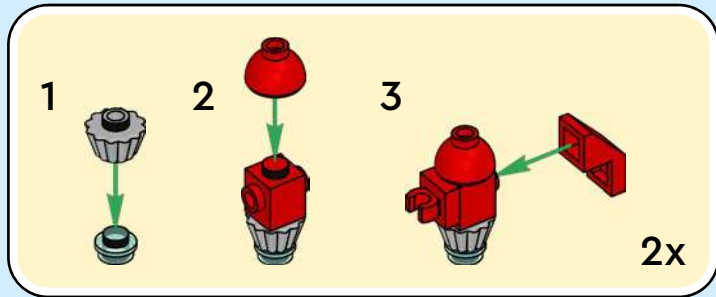

12

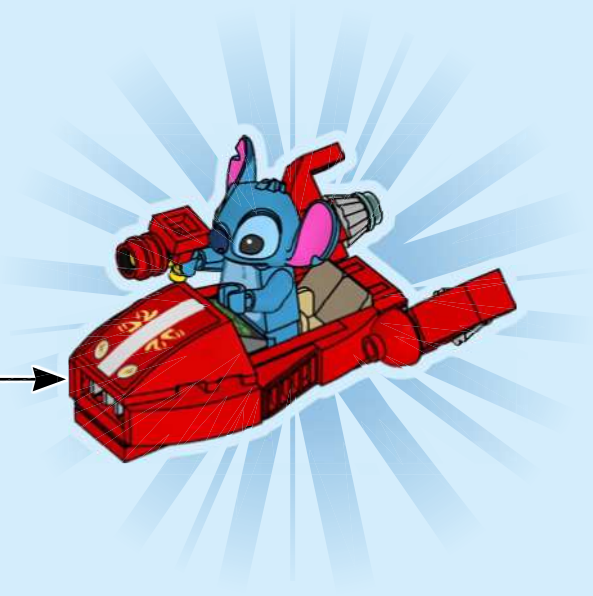

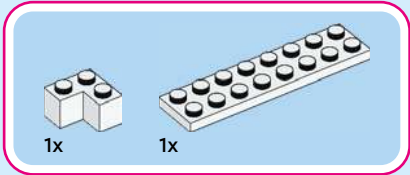
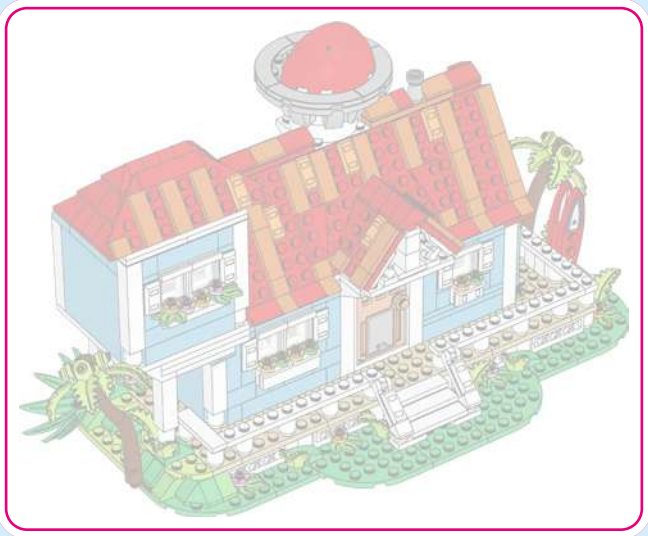

1

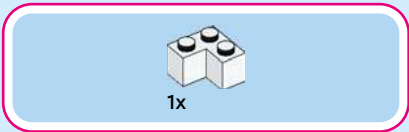
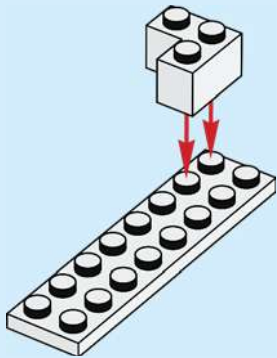

2

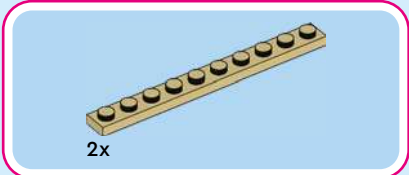
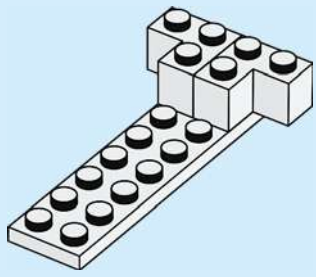

3

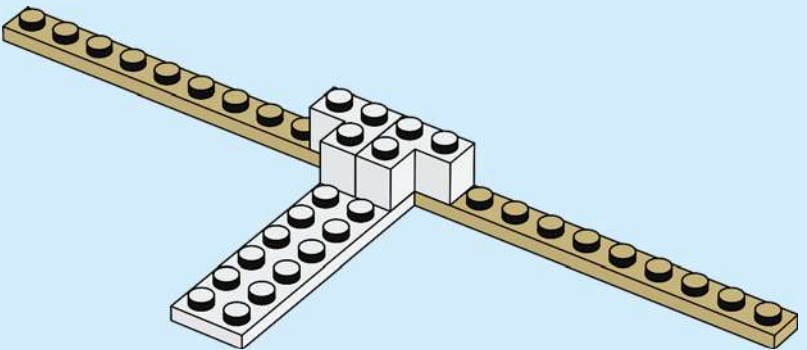

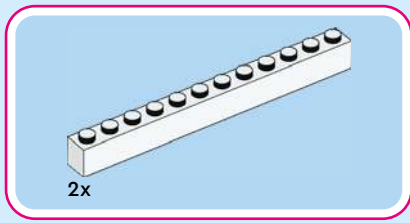

4

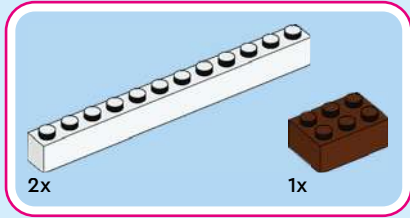
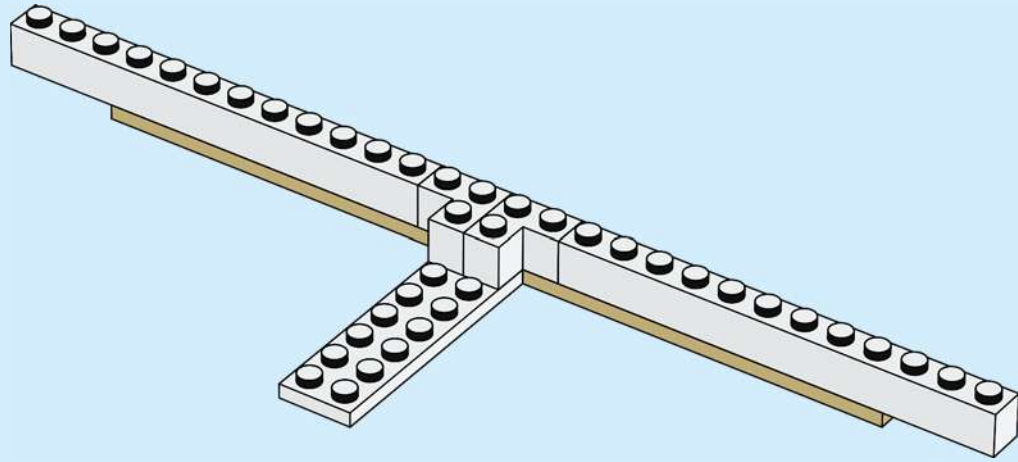

5

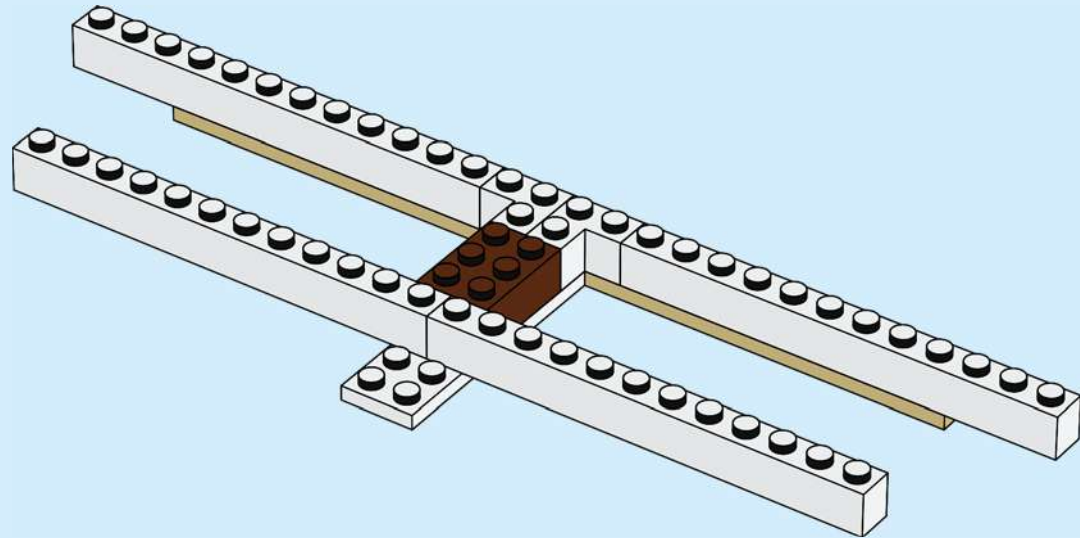

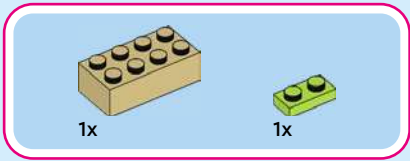

6

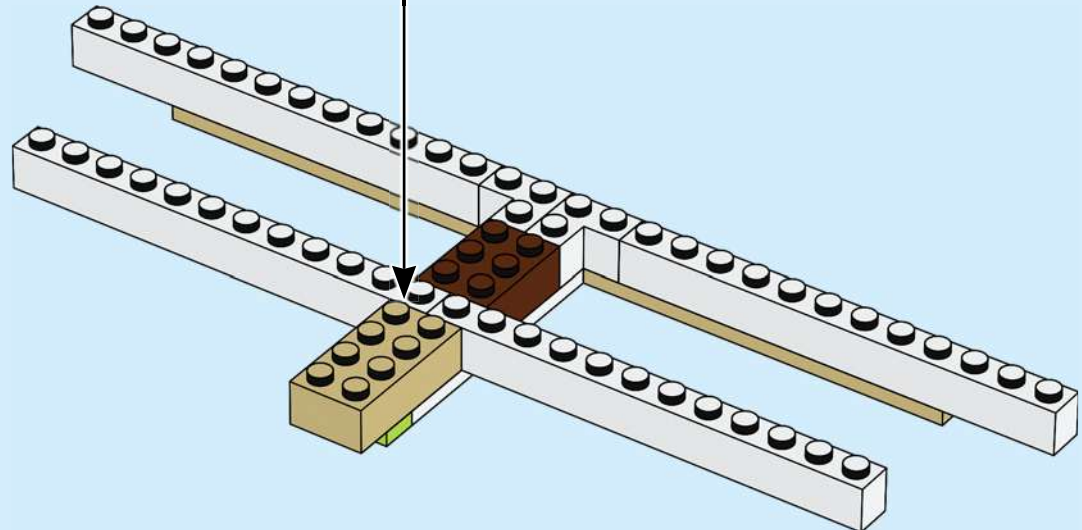
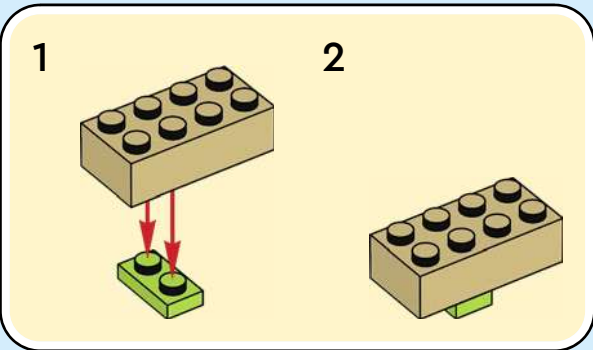

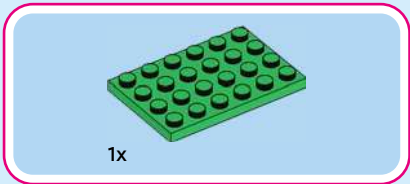

7

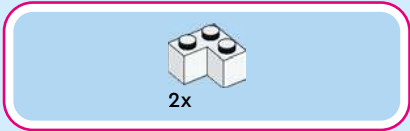
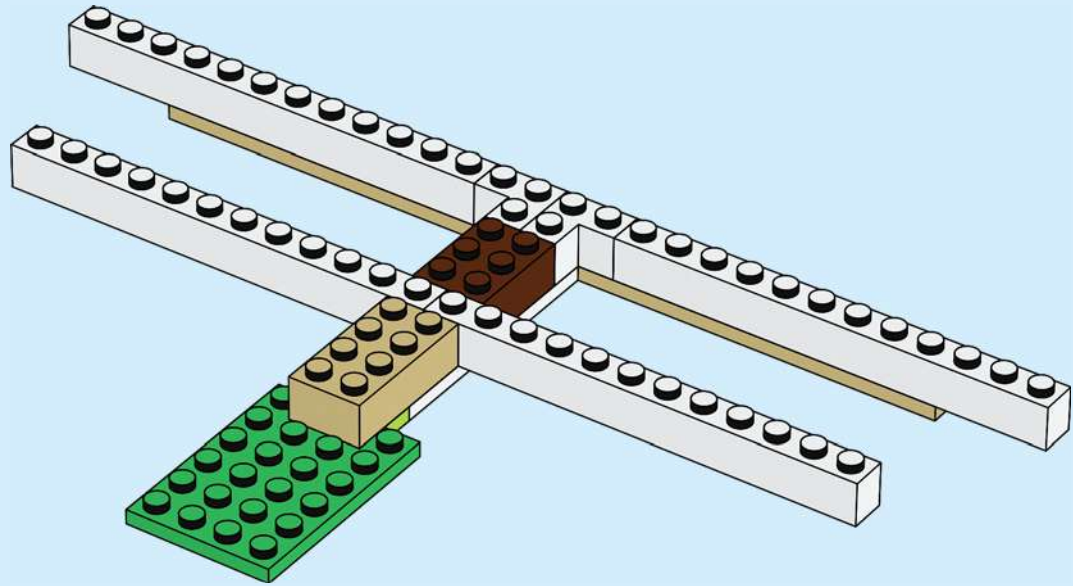

8

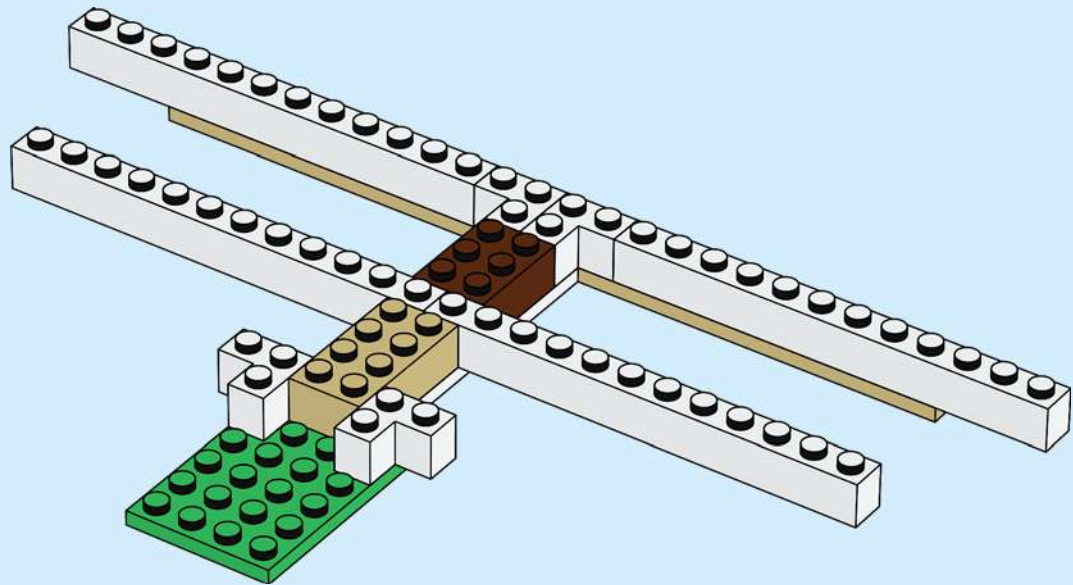

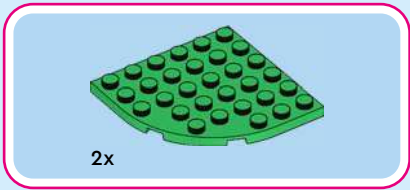

9

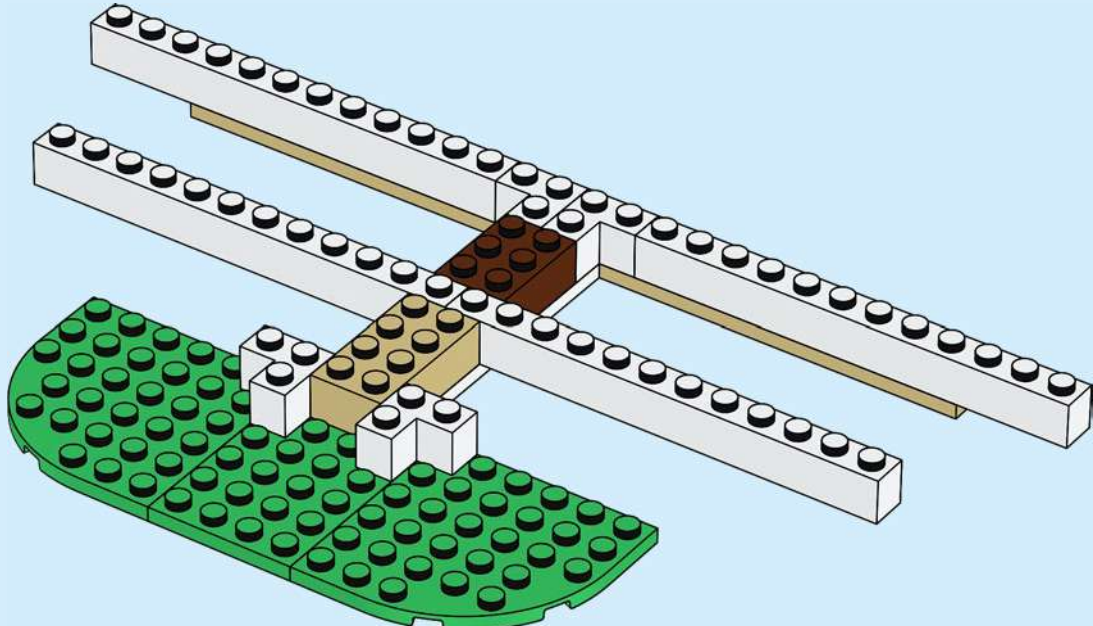

10

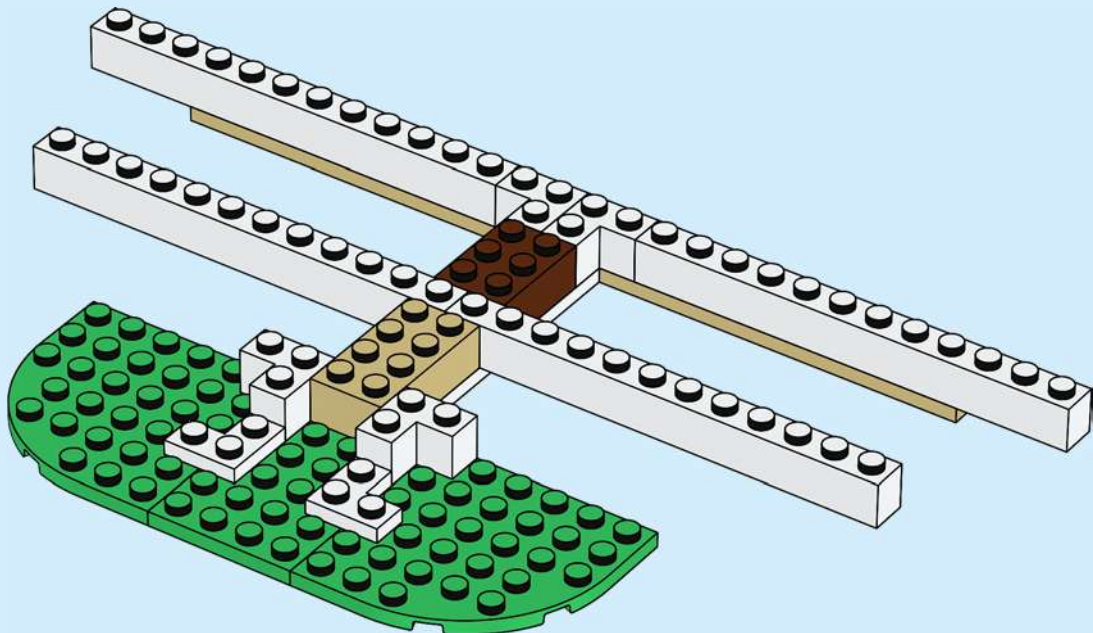

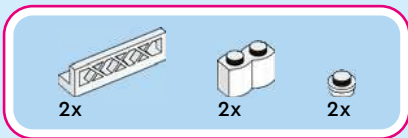

11

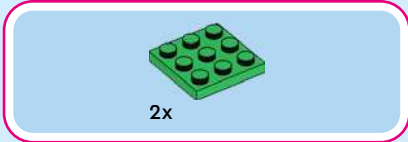
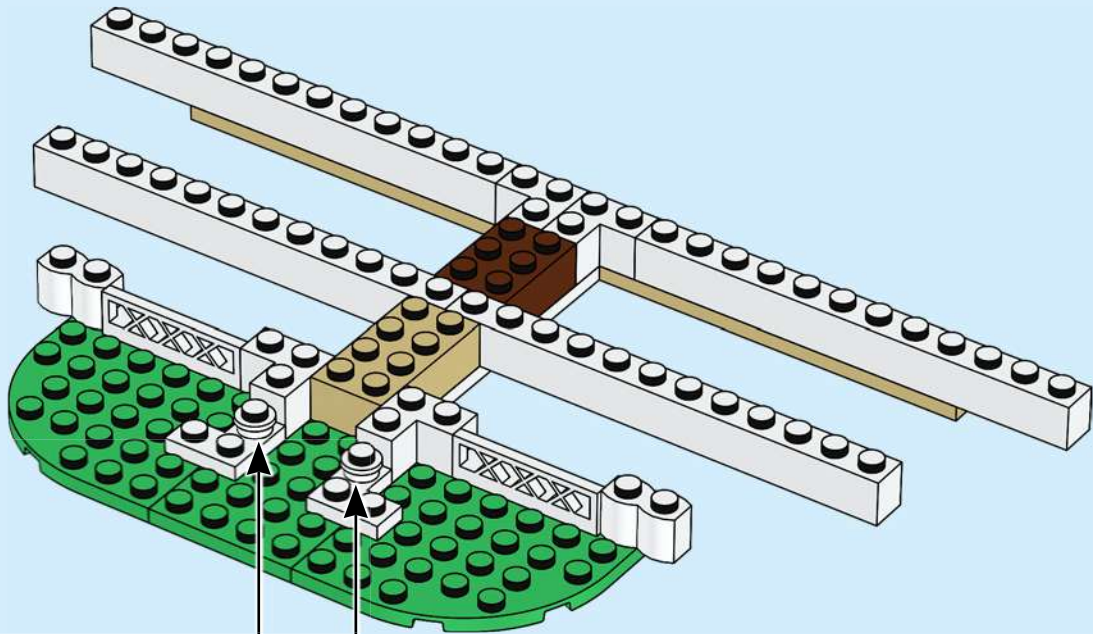

12

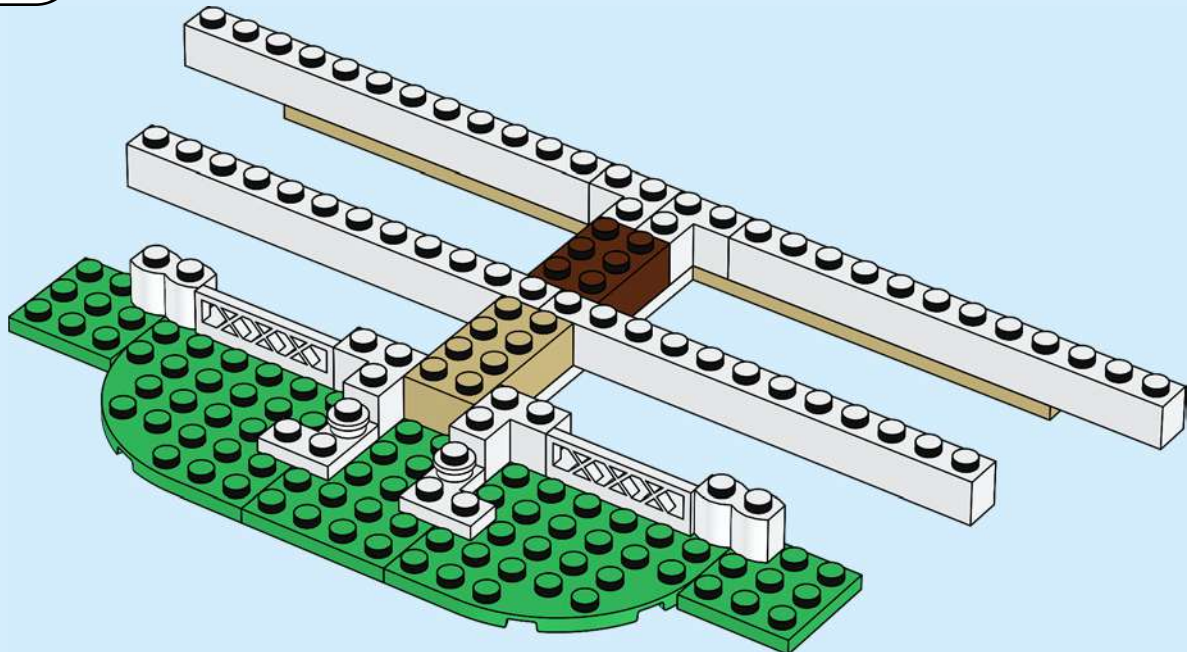



13

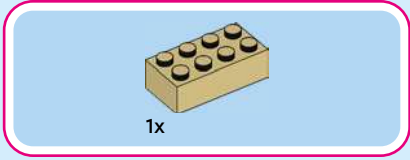
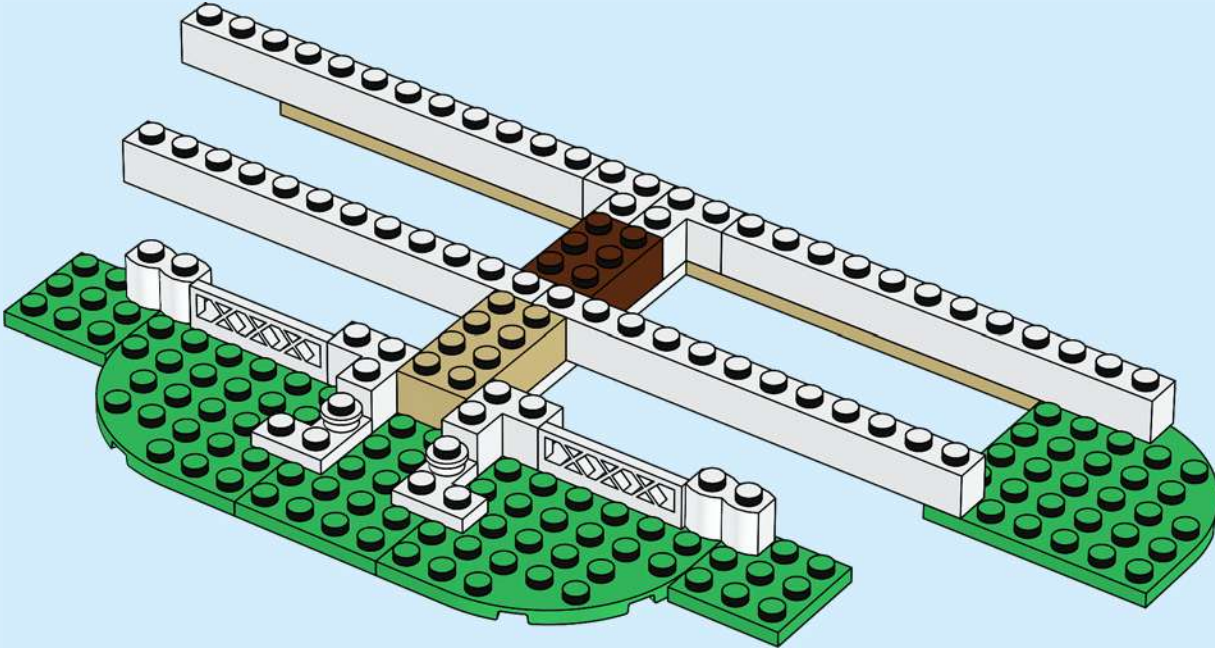

14

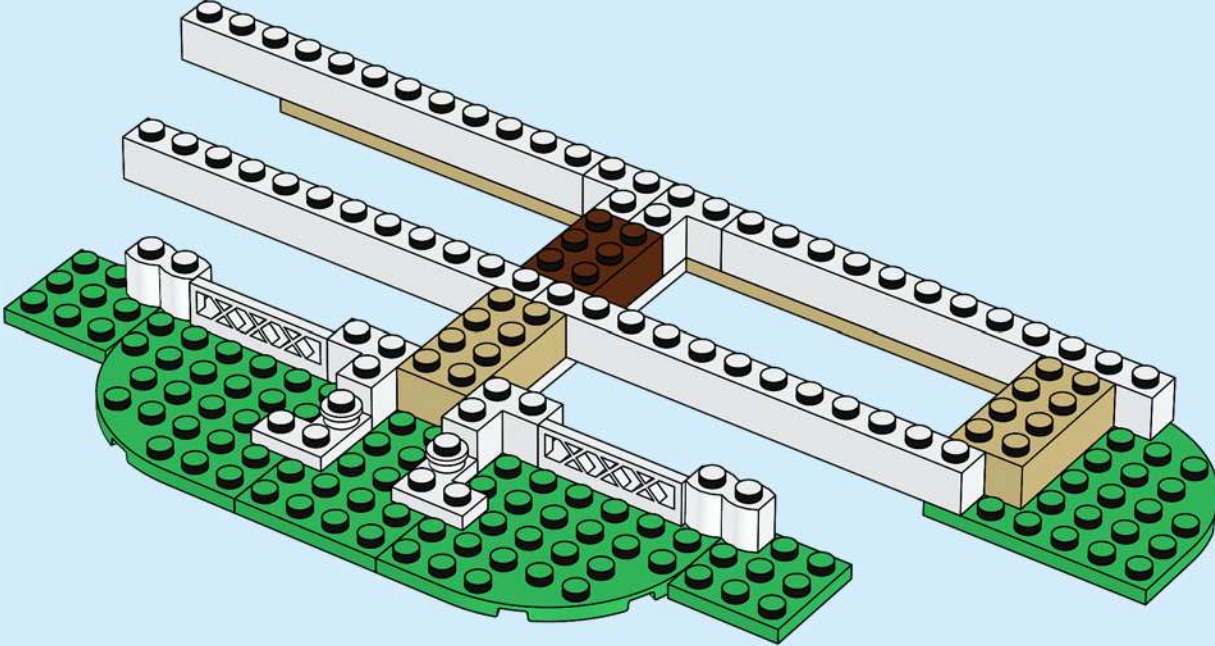

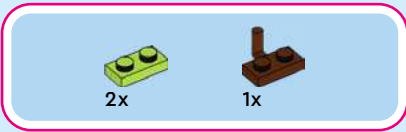

15

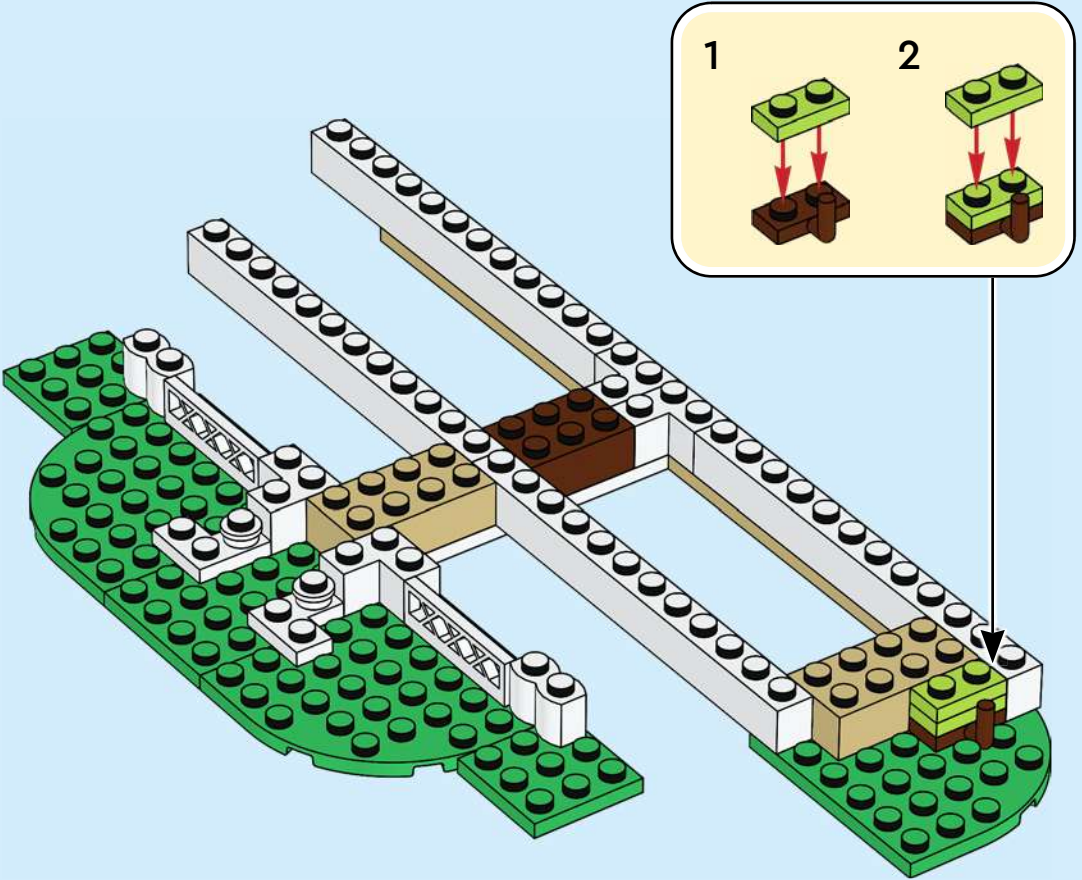

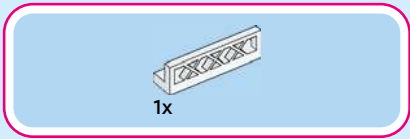

16

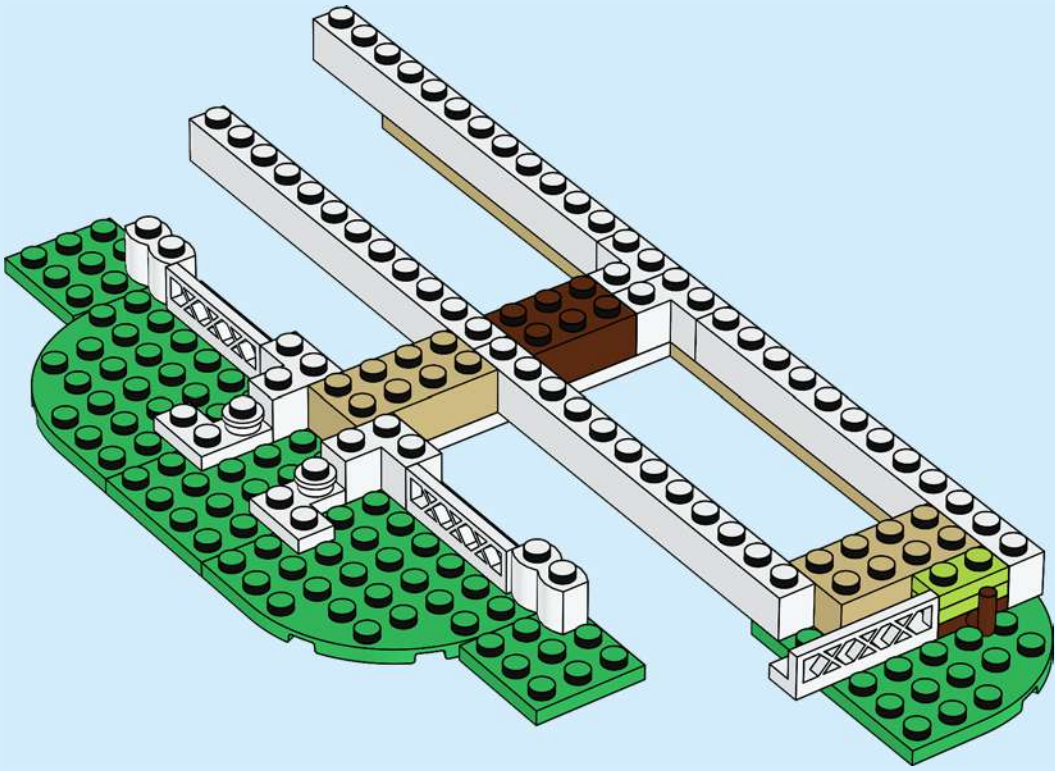

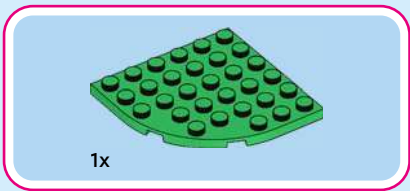

17

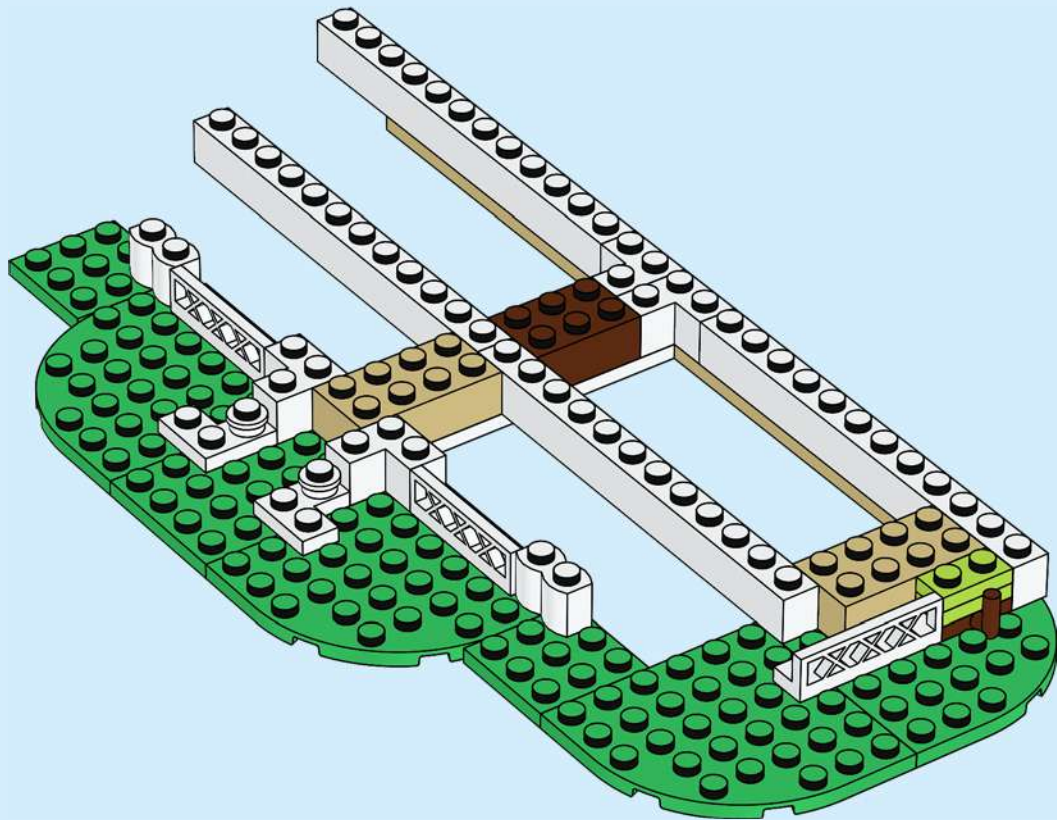

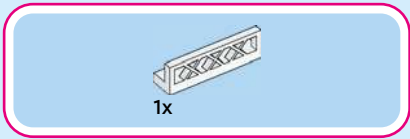

18

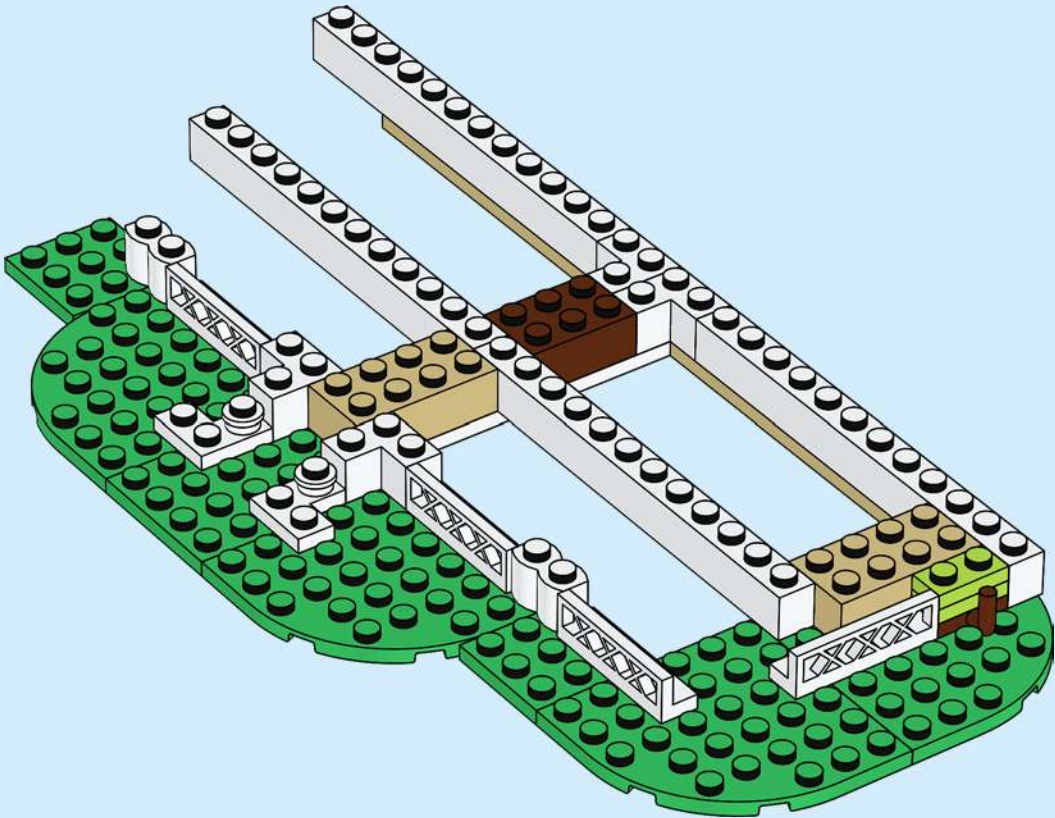

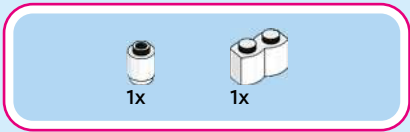

19

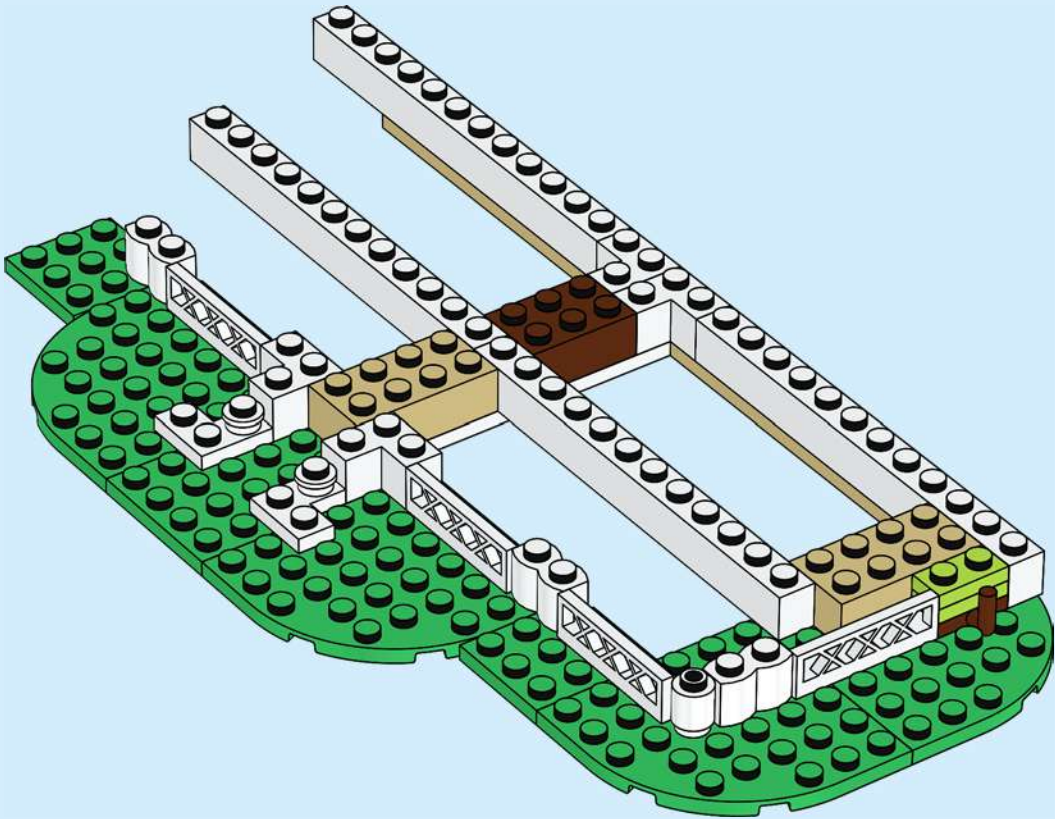

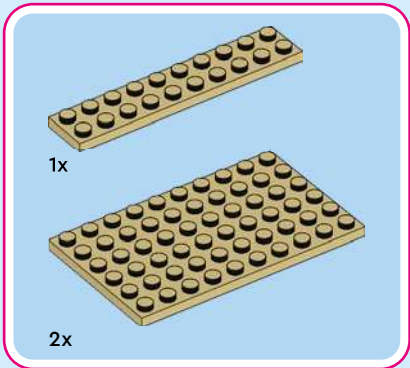

20

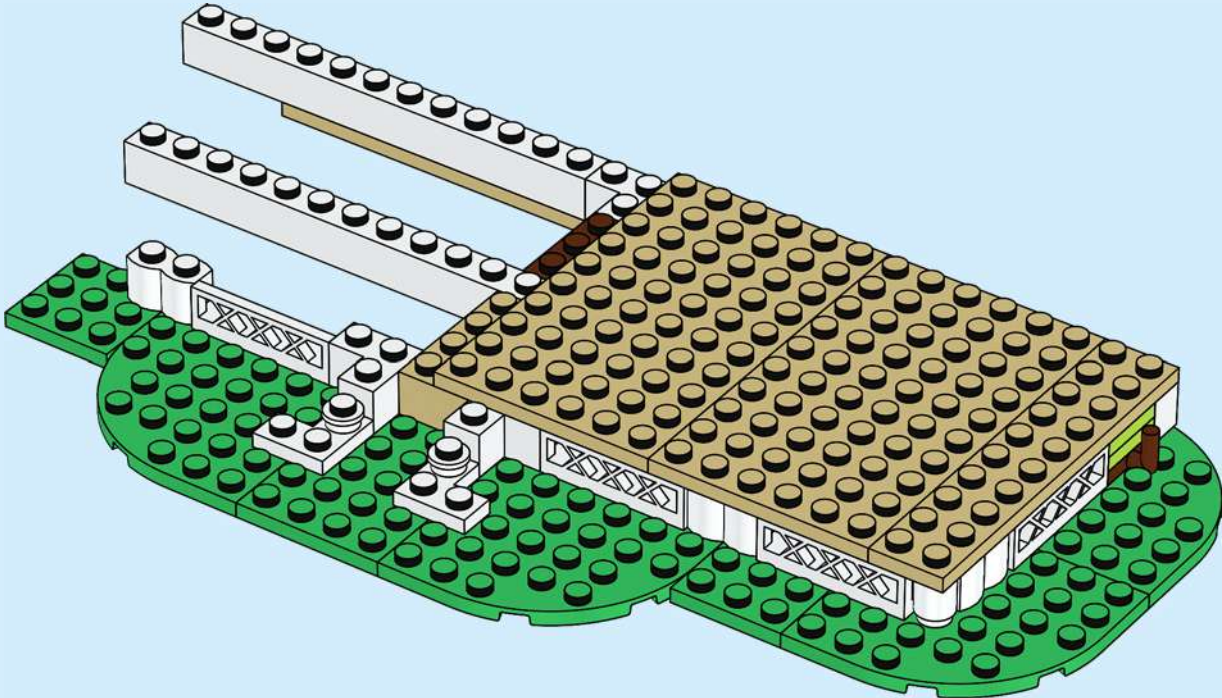



21

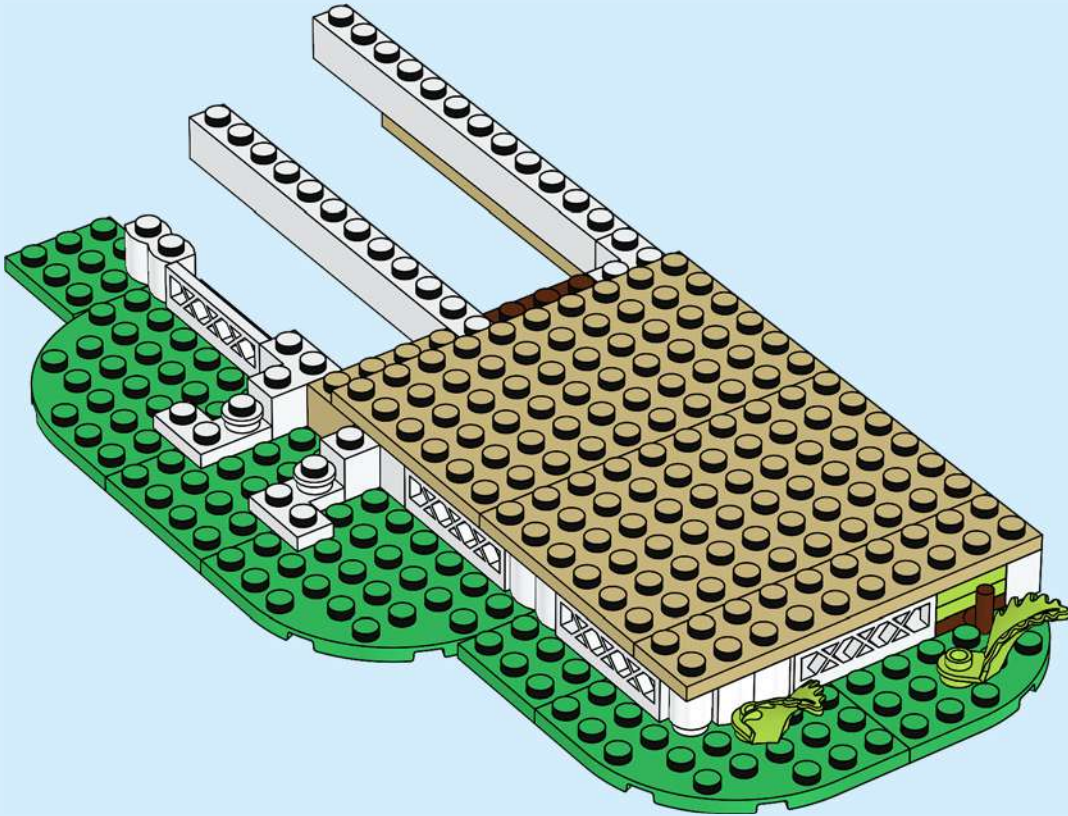



2x



1x

22

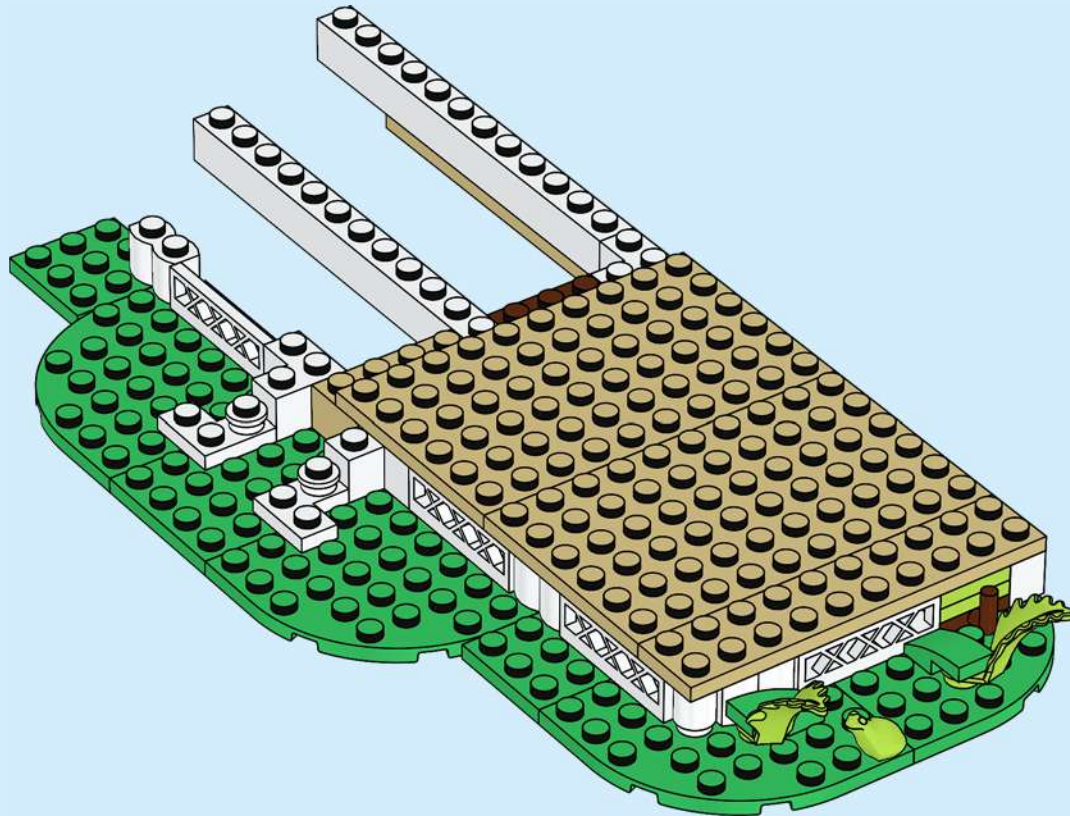

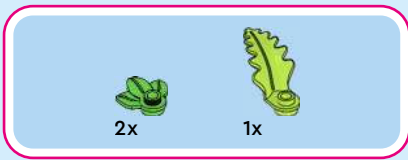

23

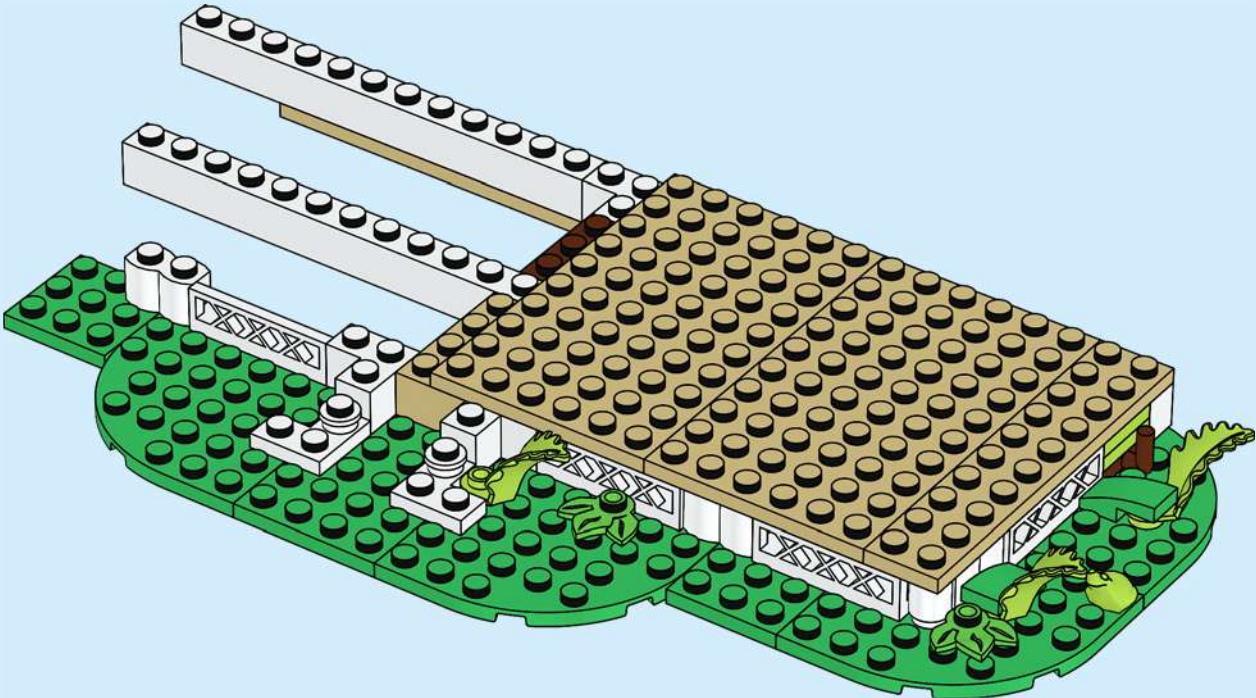



2x



1x

24





25

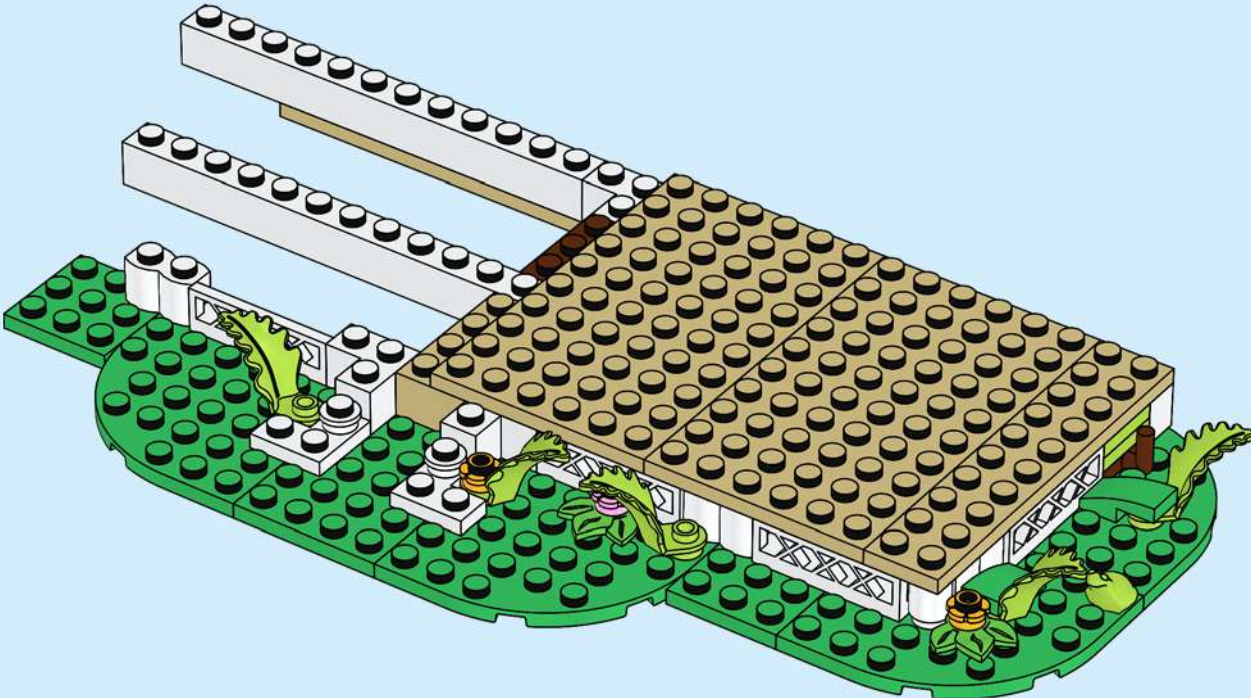



1x



1x

26

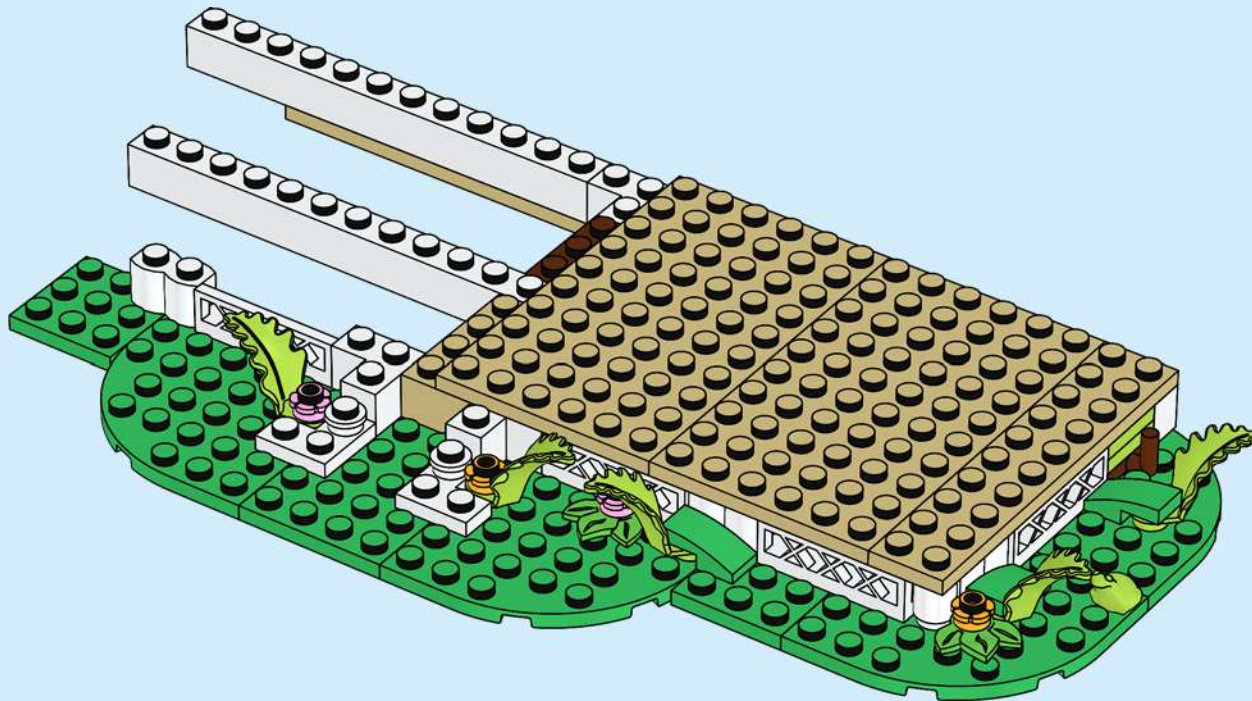

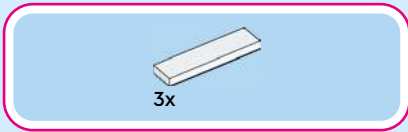

27

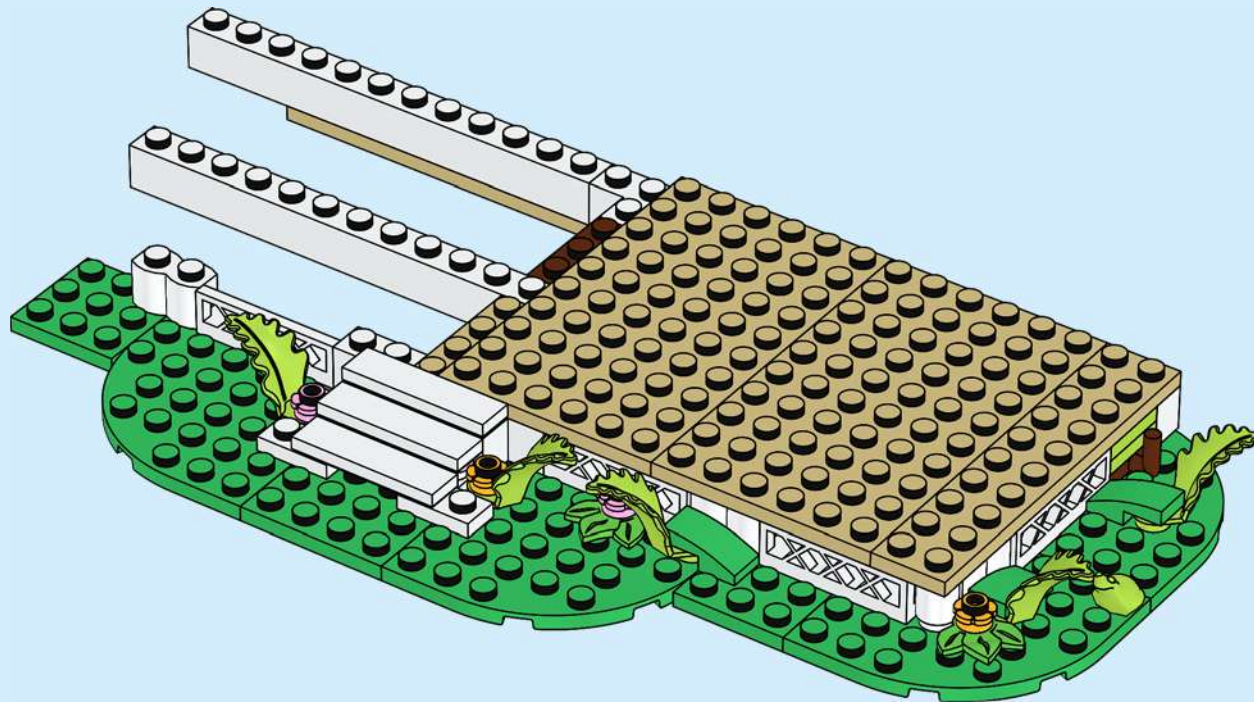



2x



2x

28

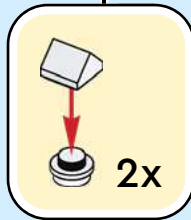
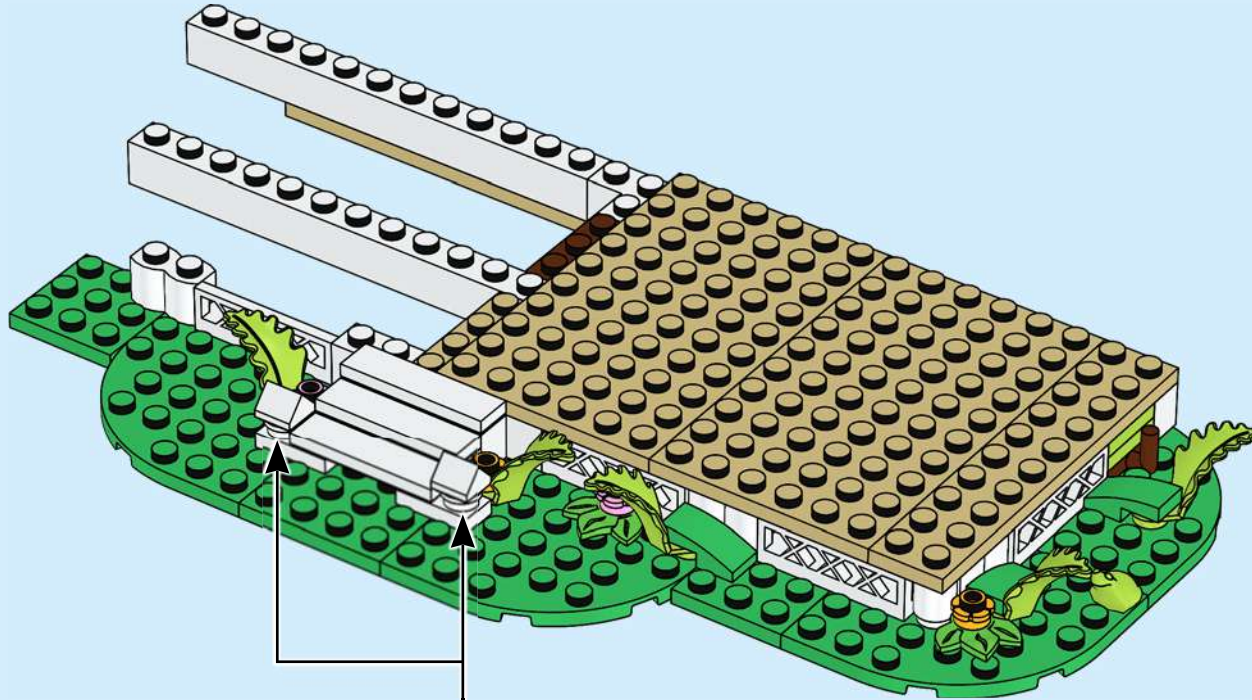

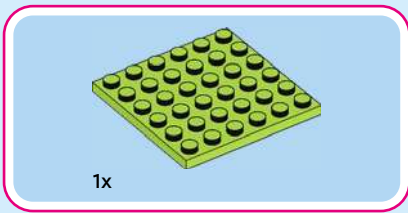

29

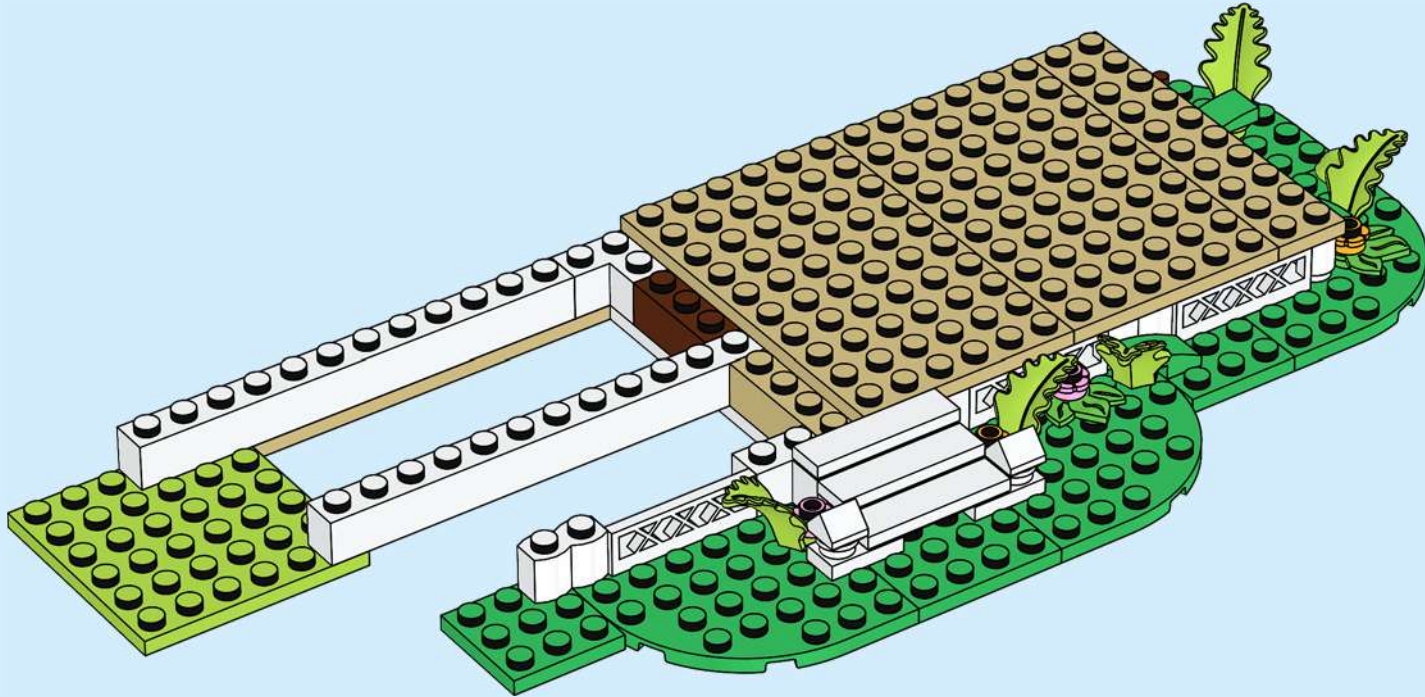

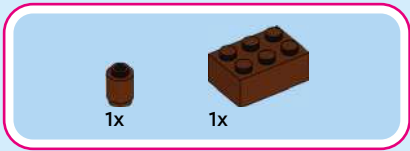

30

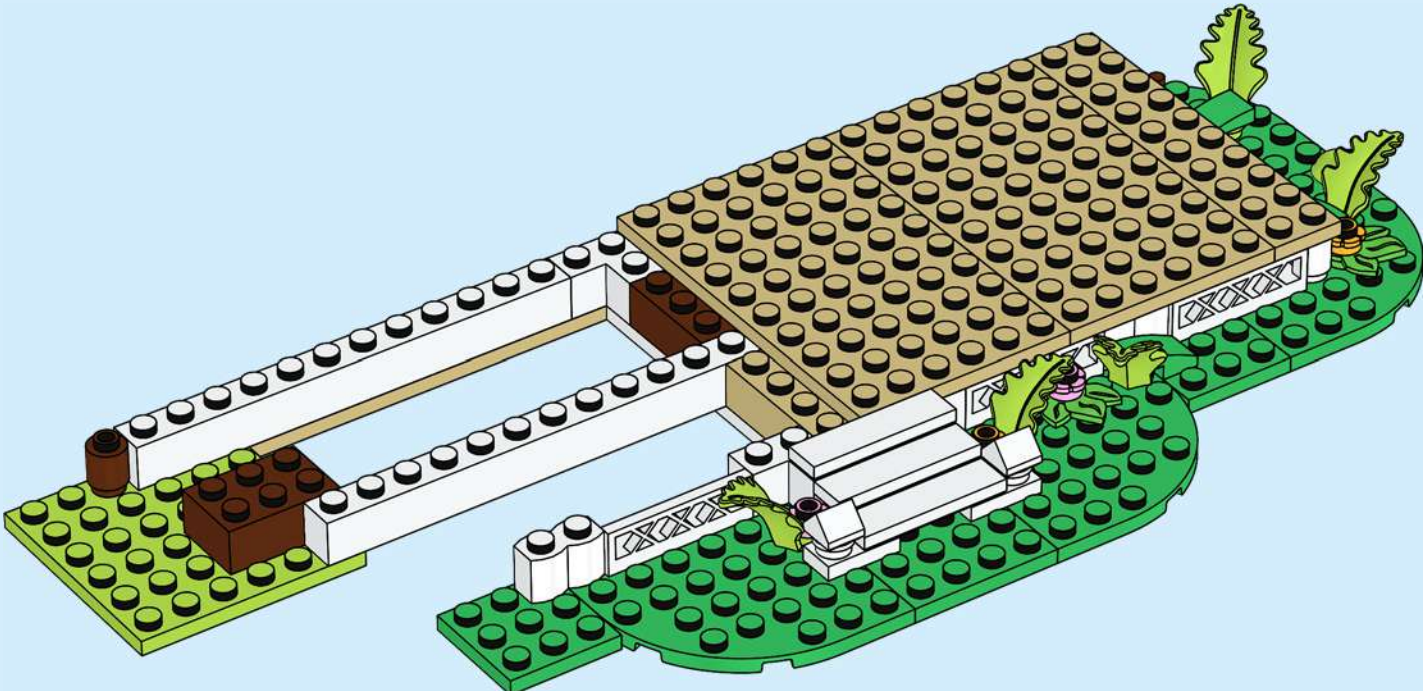

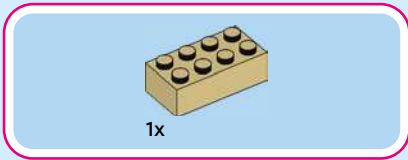

31

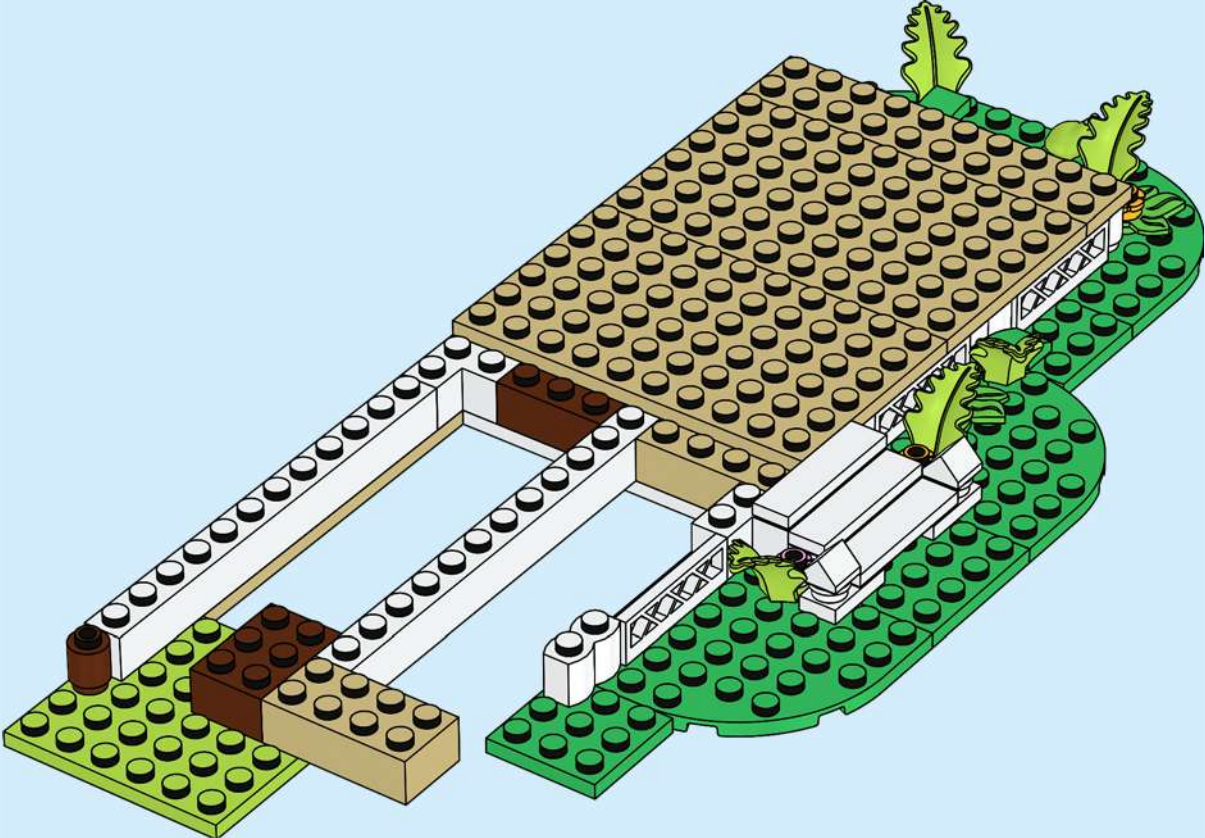

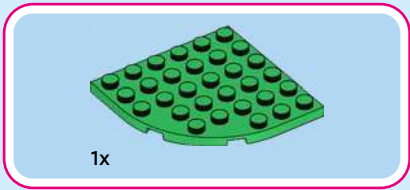

32

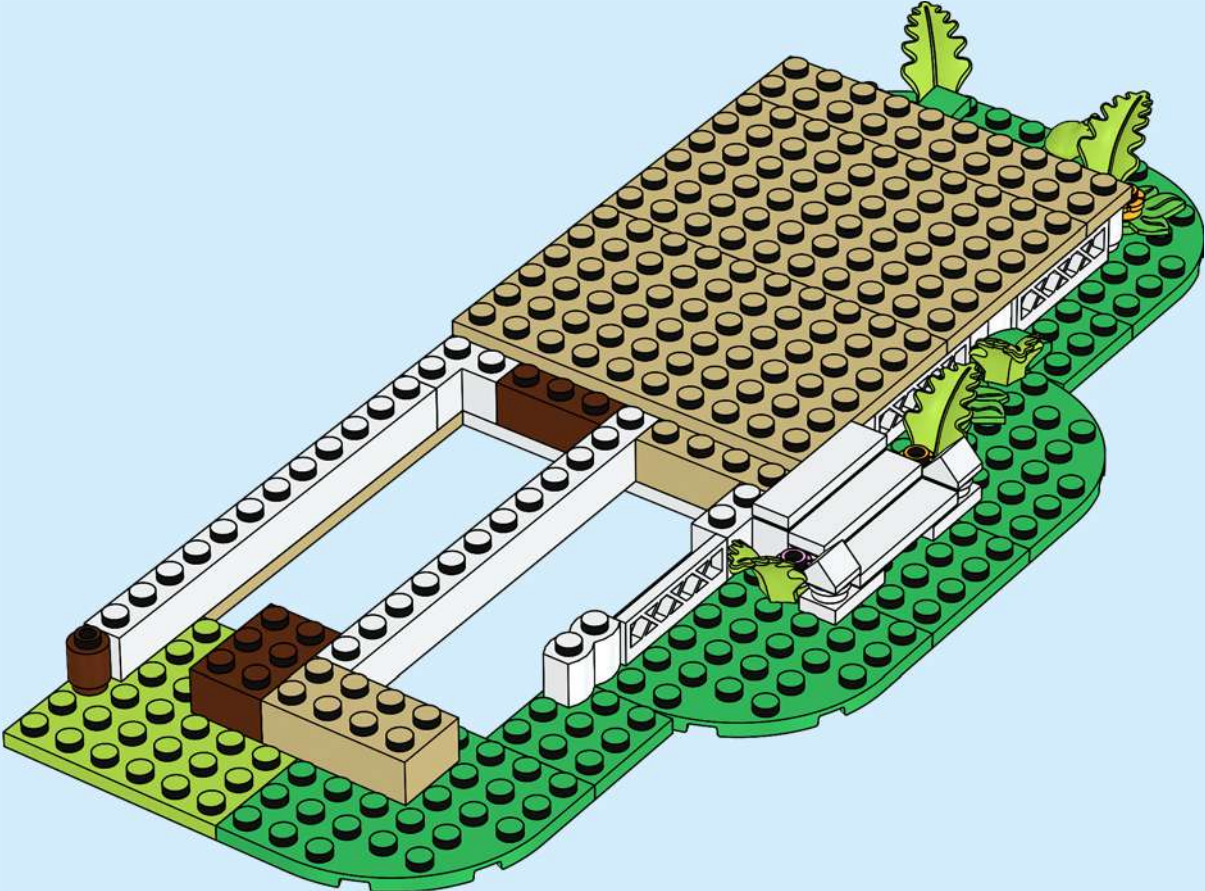

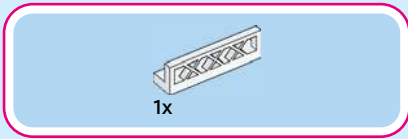

33

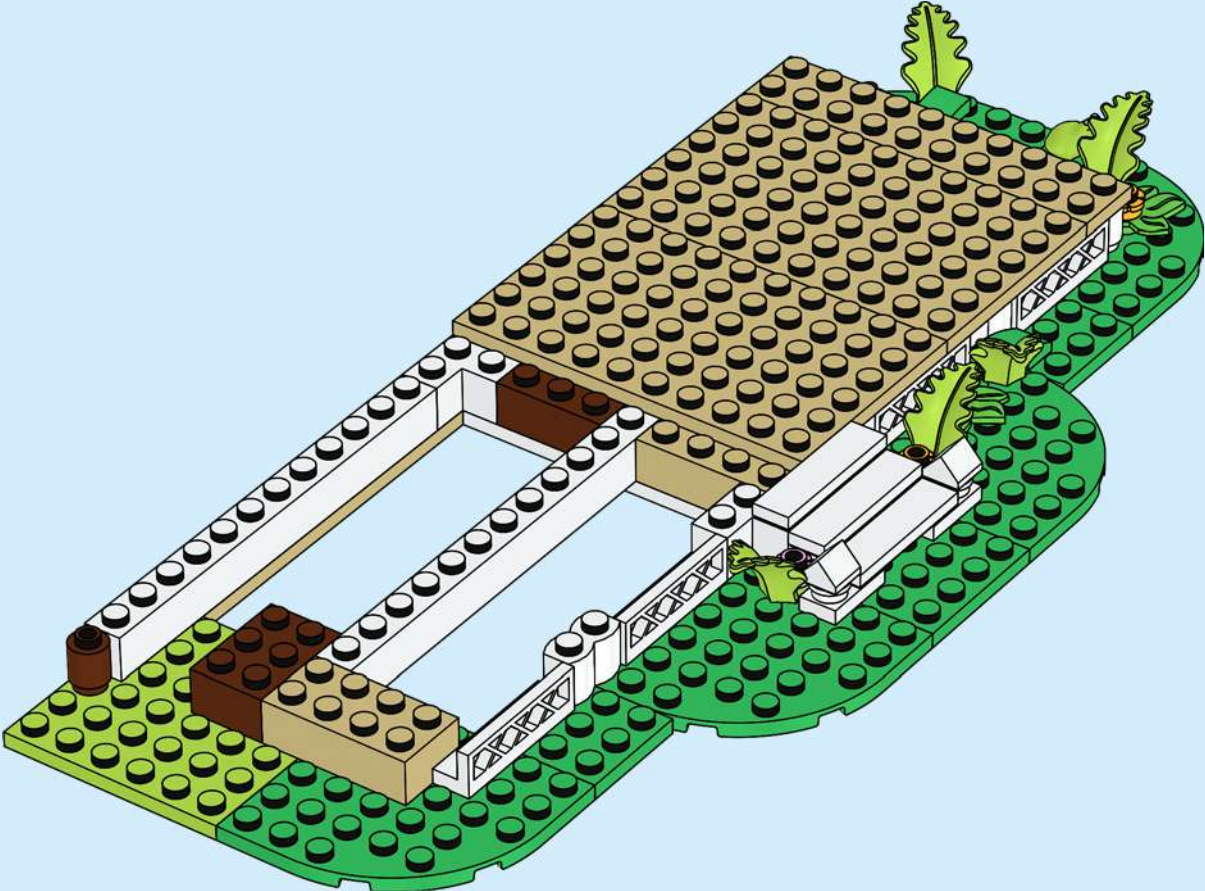



2x



1x

34

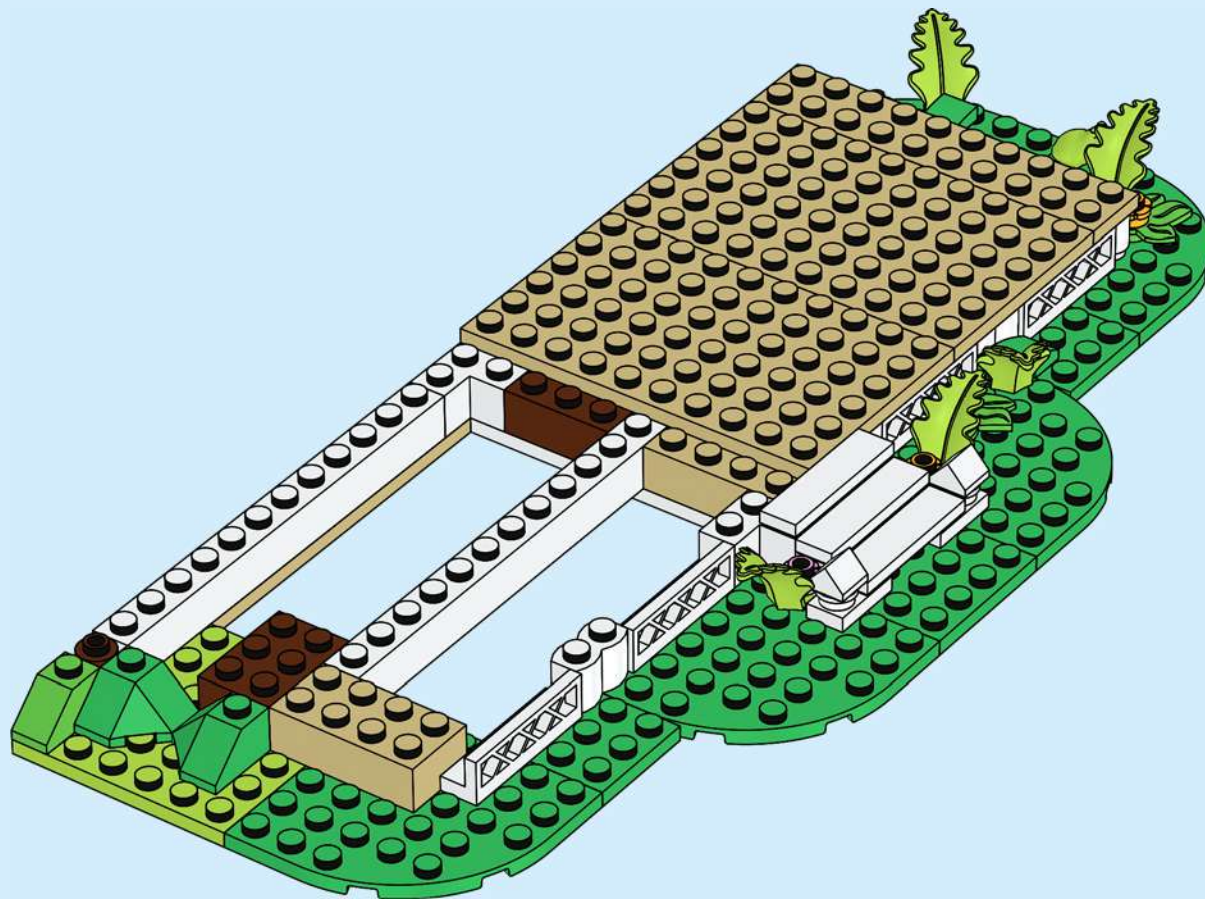



35

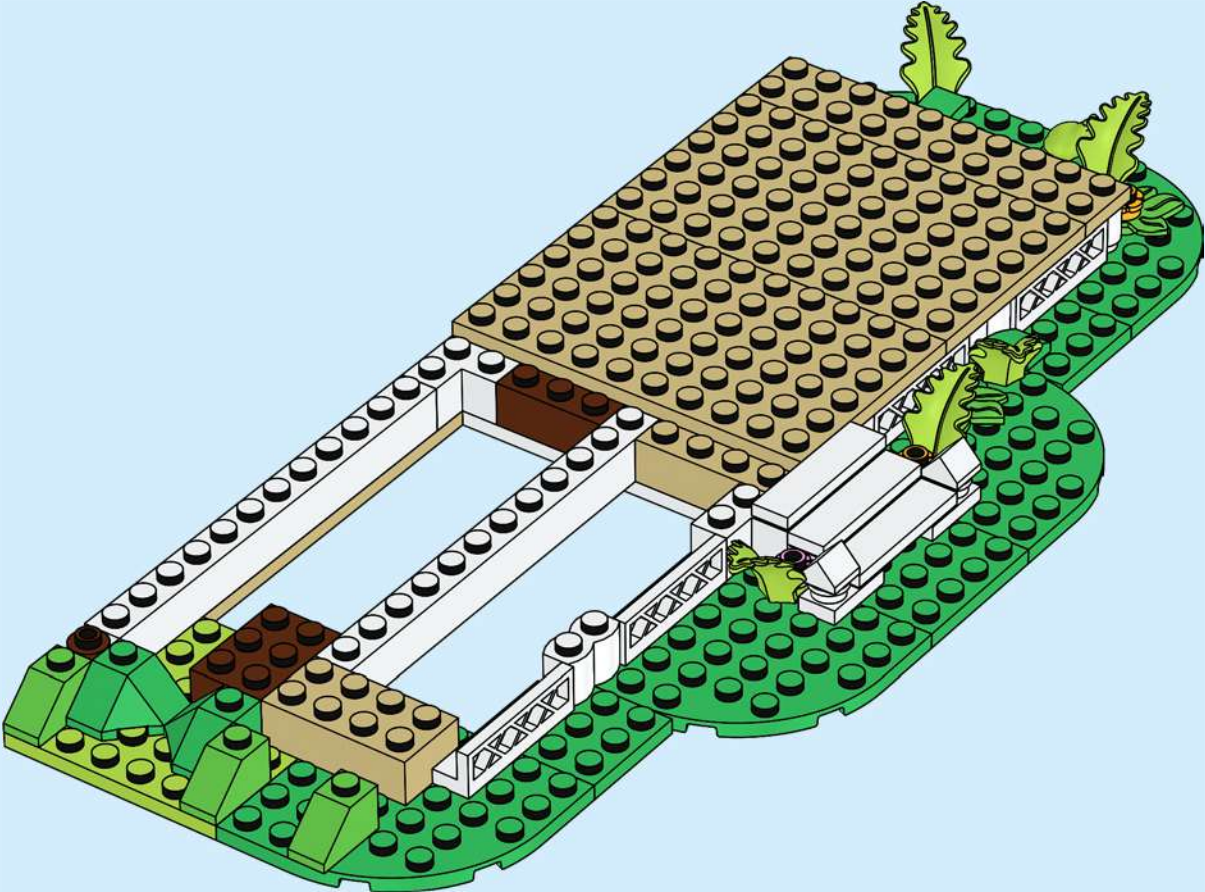

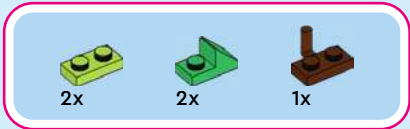

36

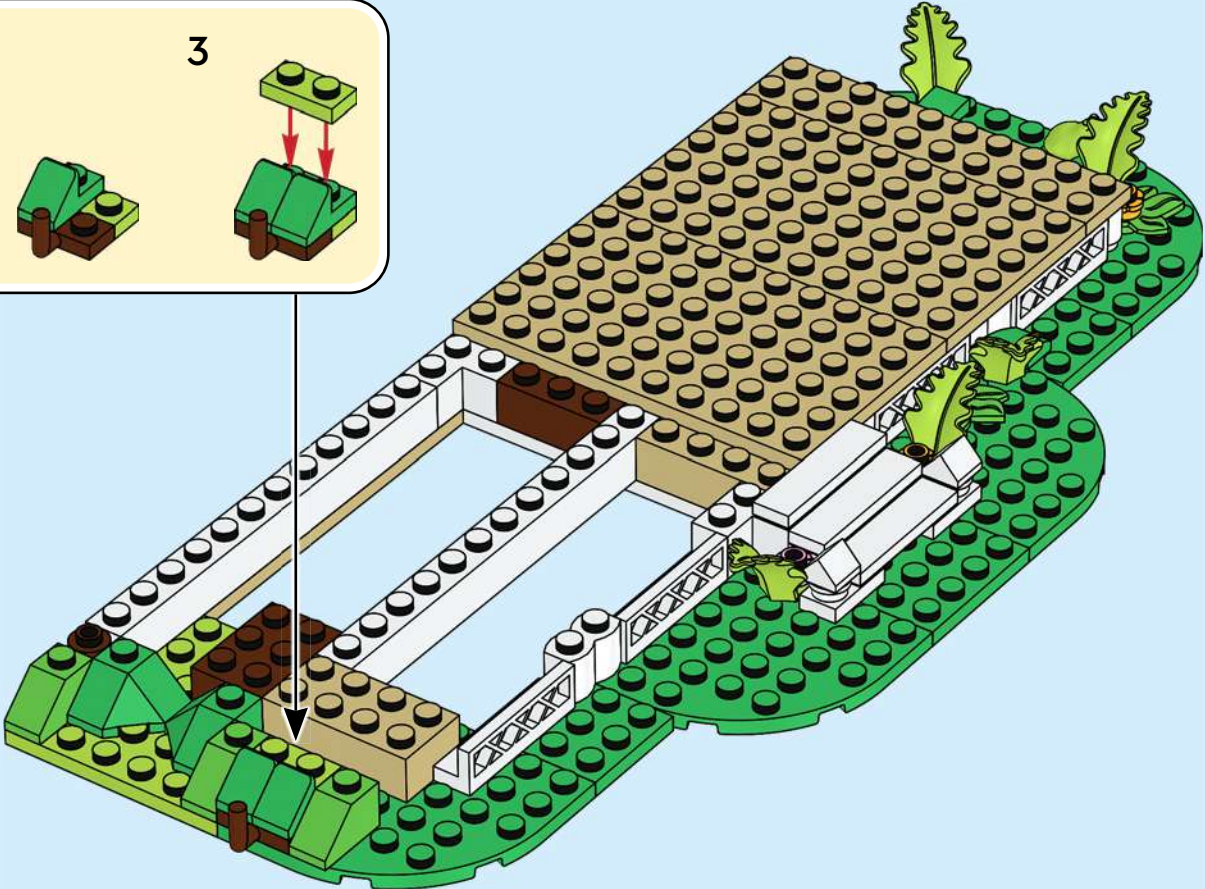
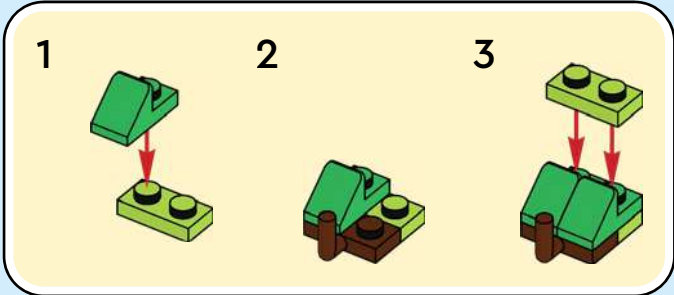

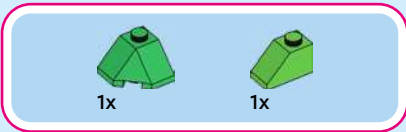

37

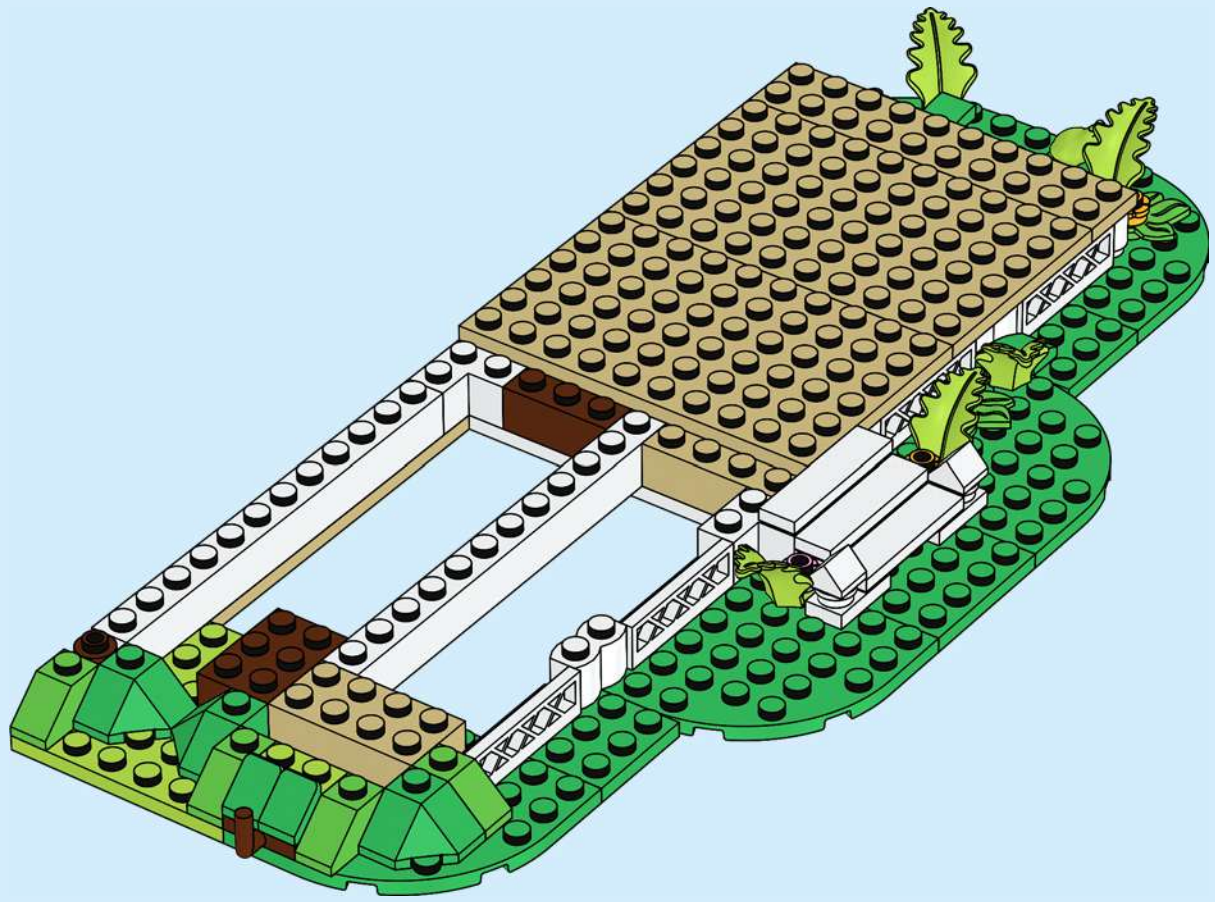

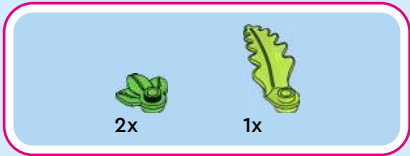

38

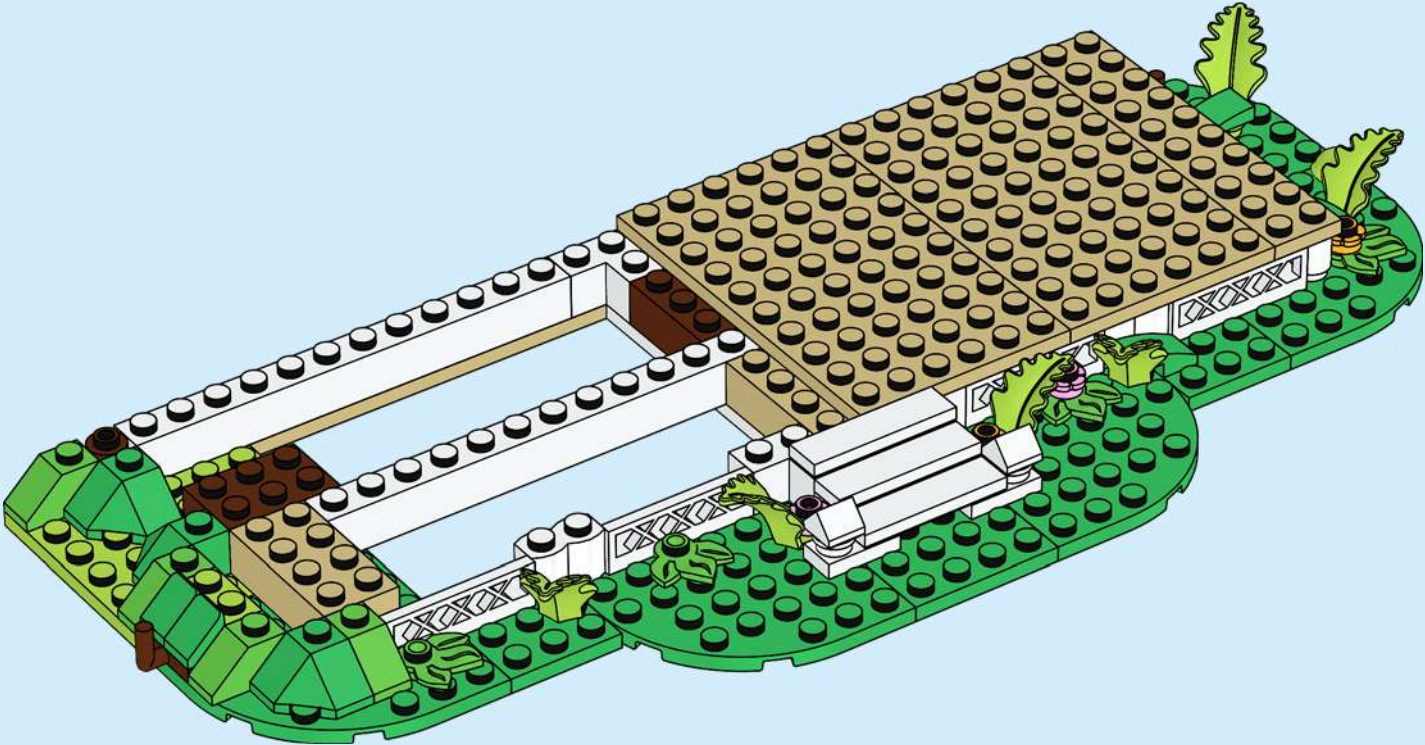

1x  1x  1x 

39

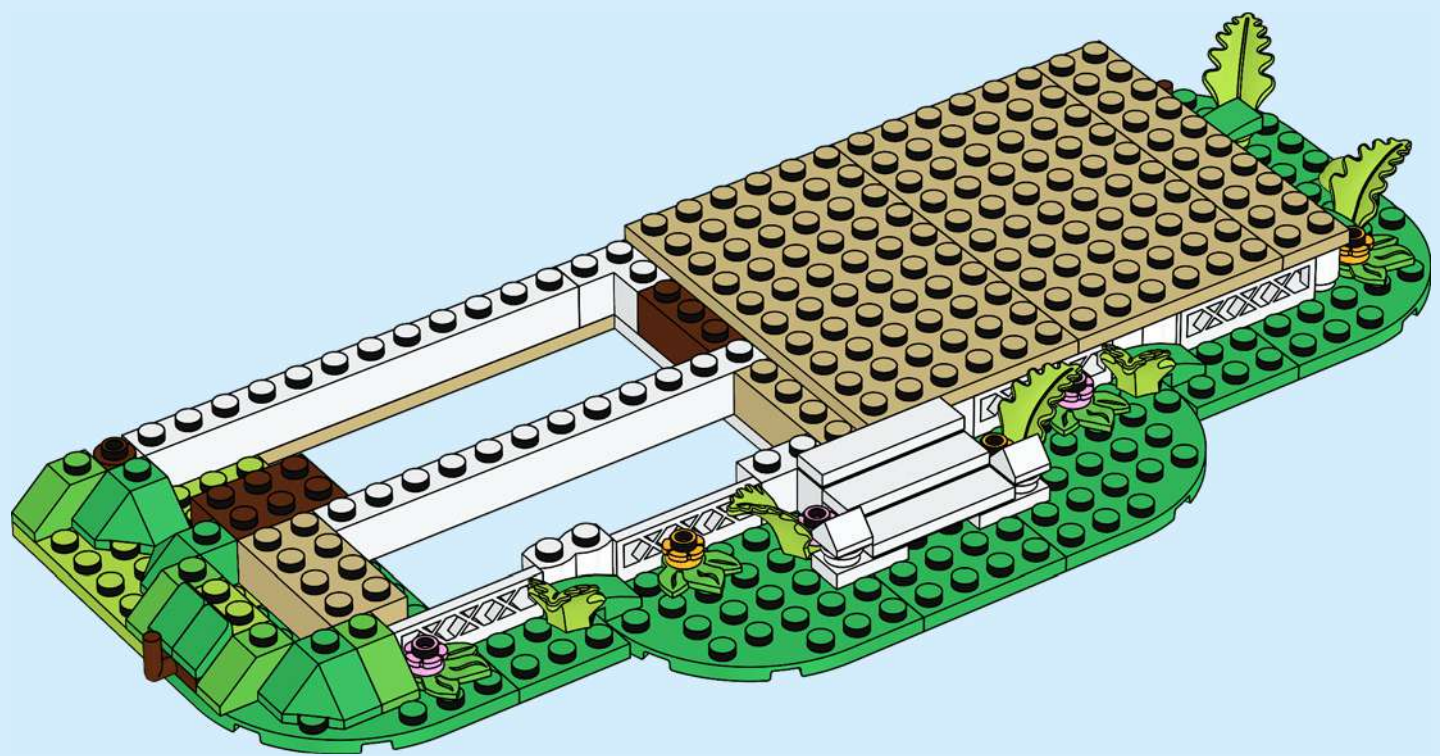

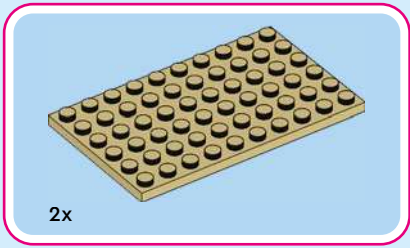

40

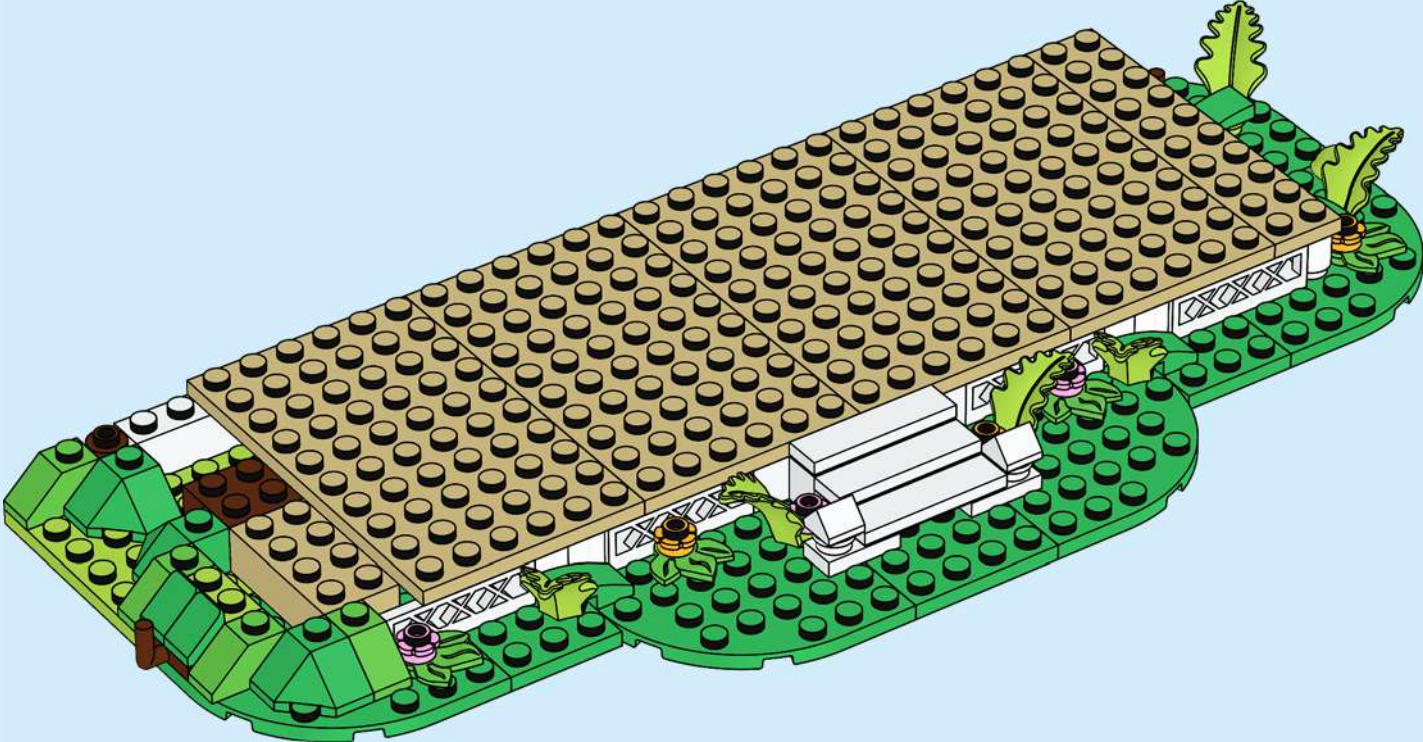

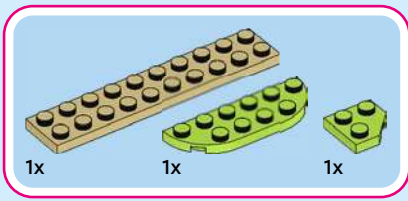

41

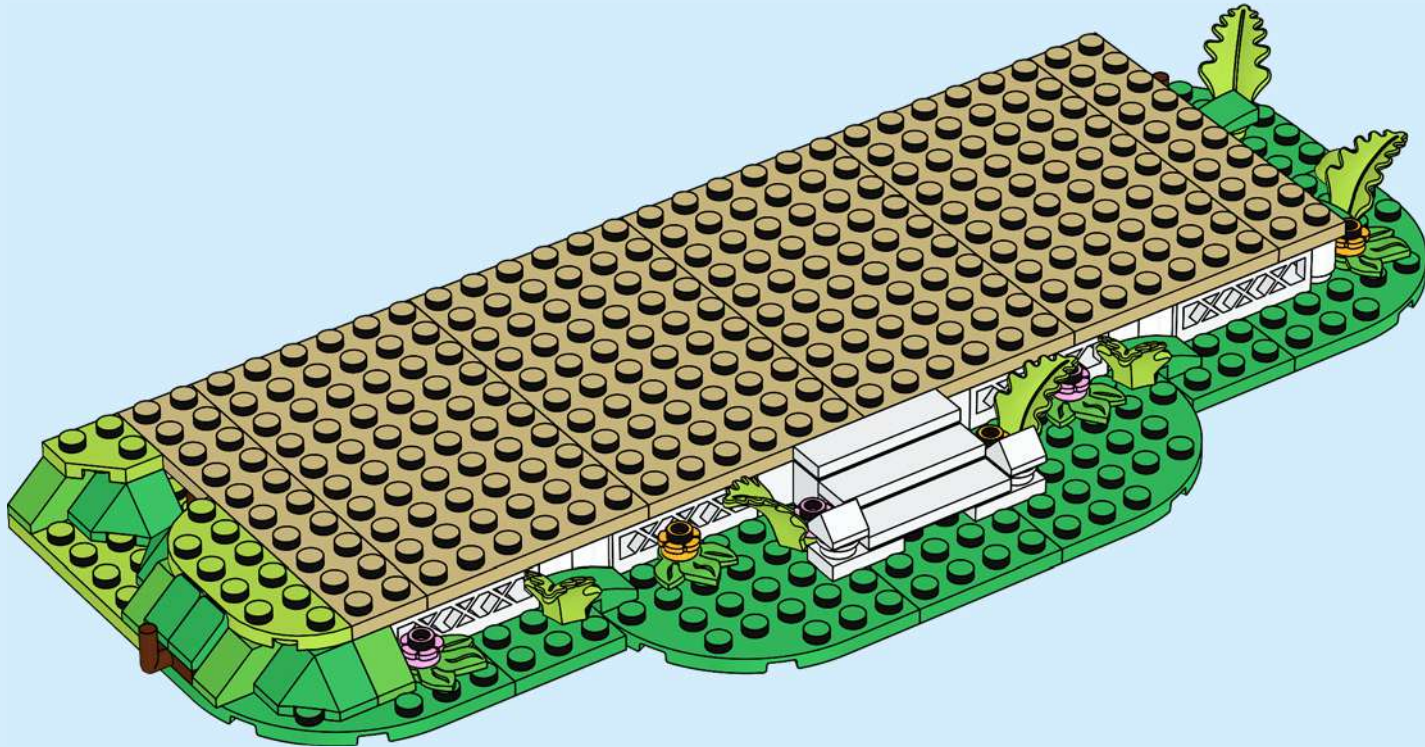

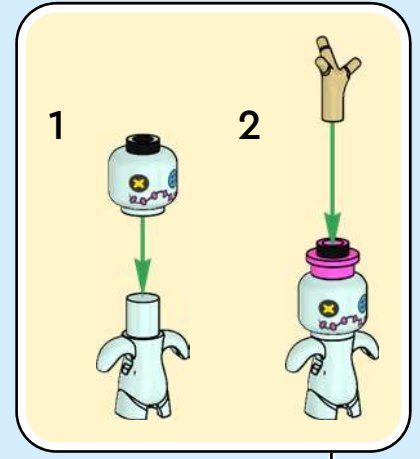
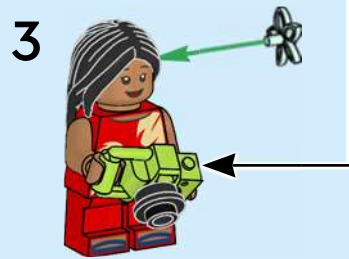
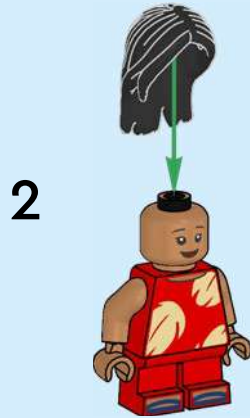
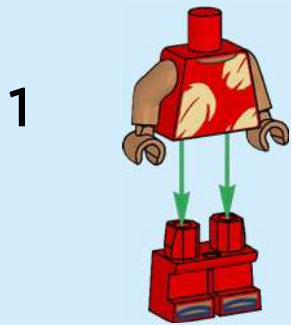

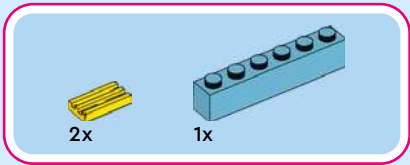

43

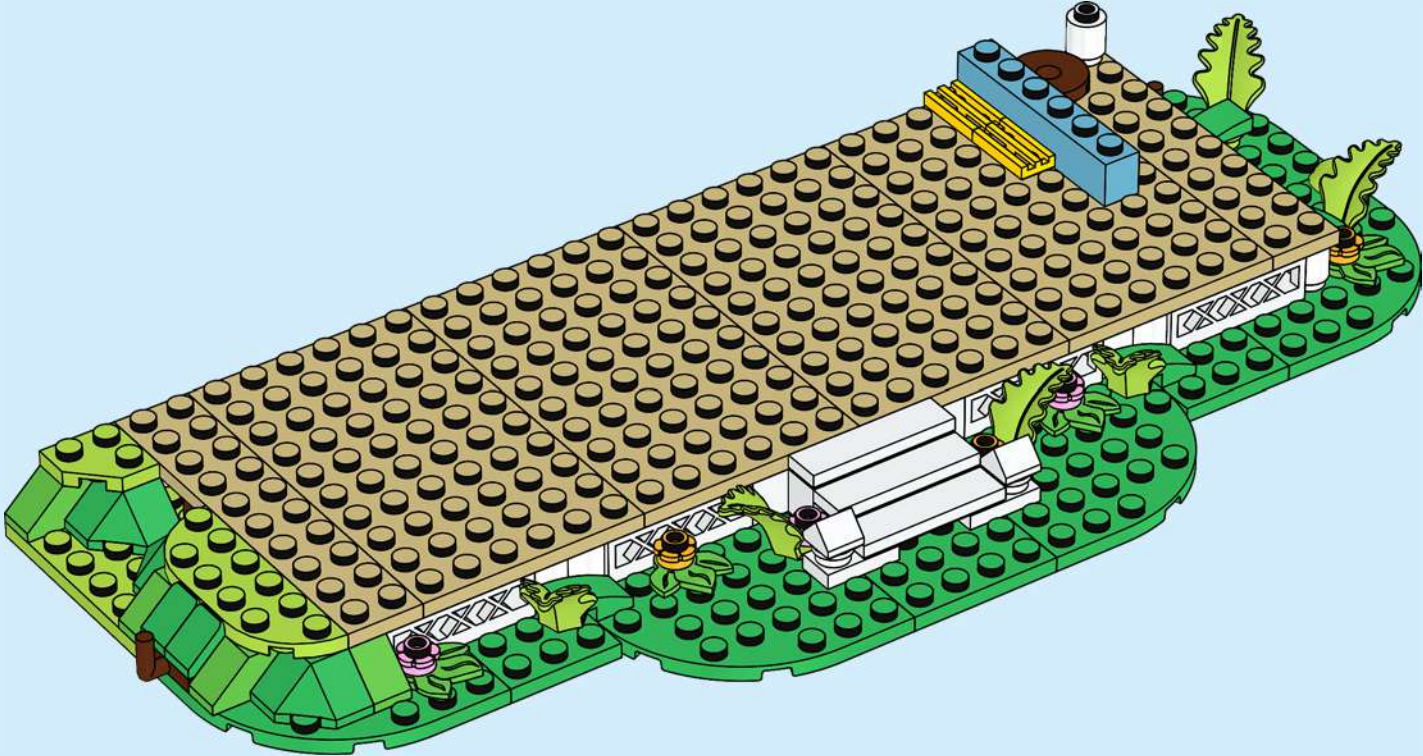

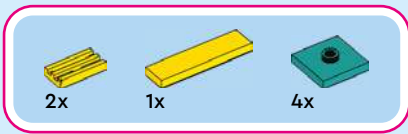

44

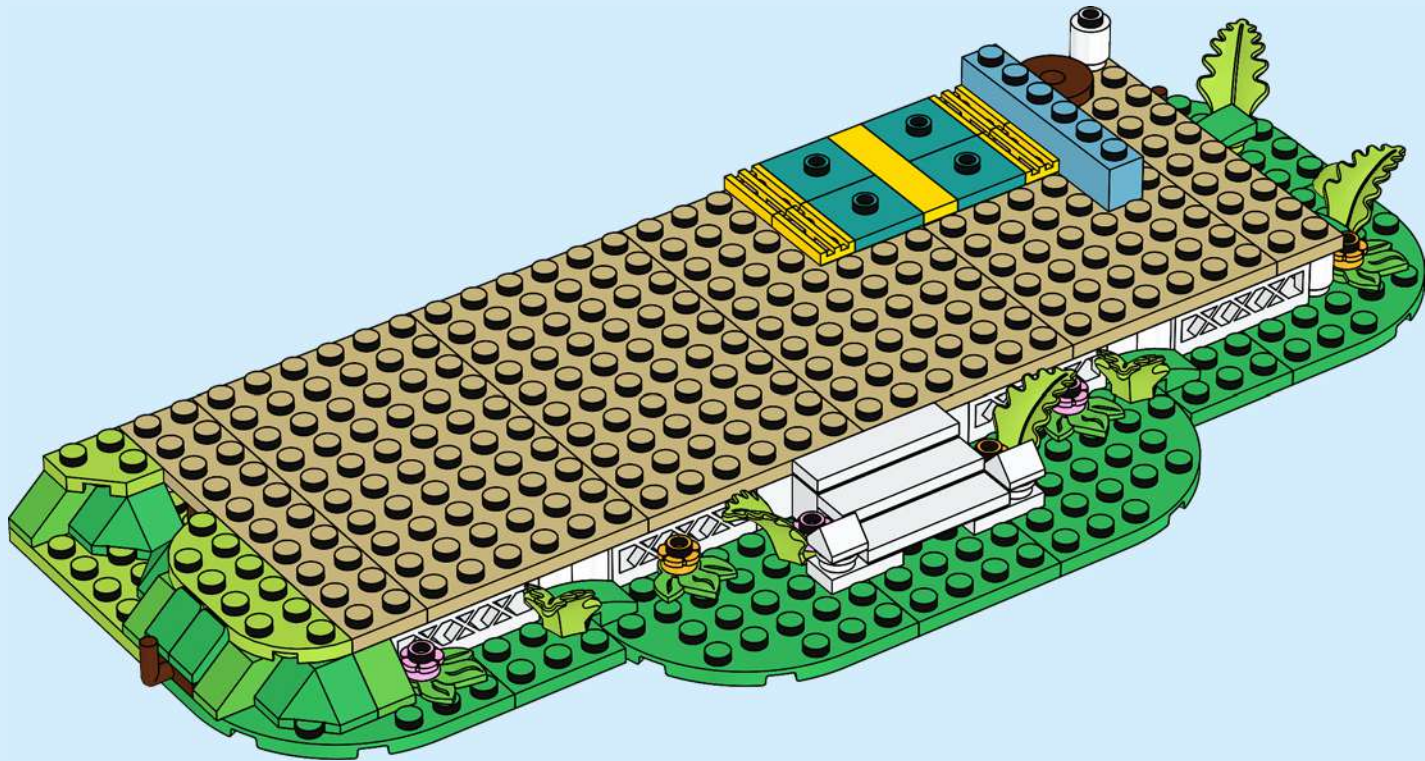



45

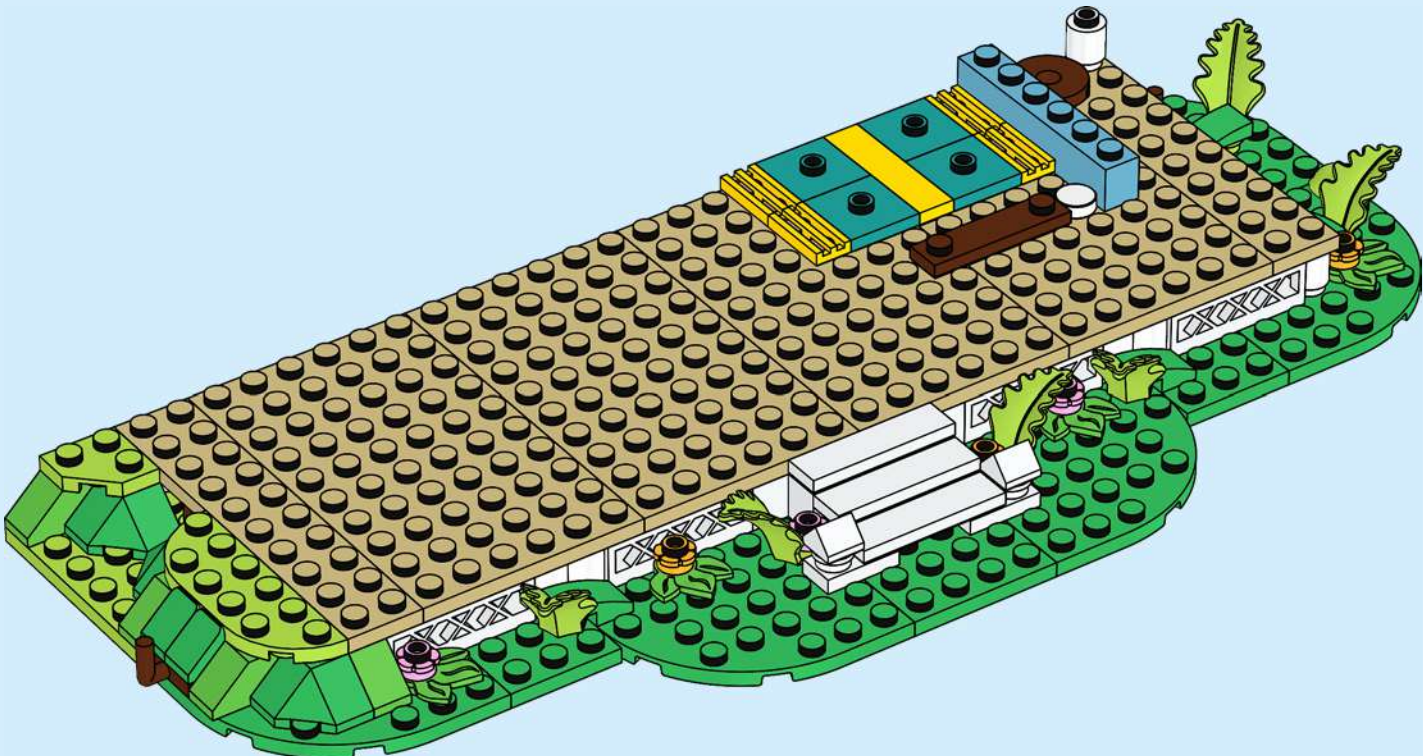

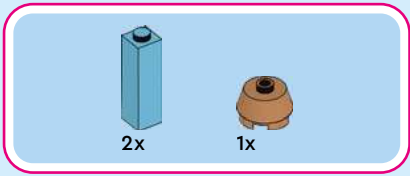

46

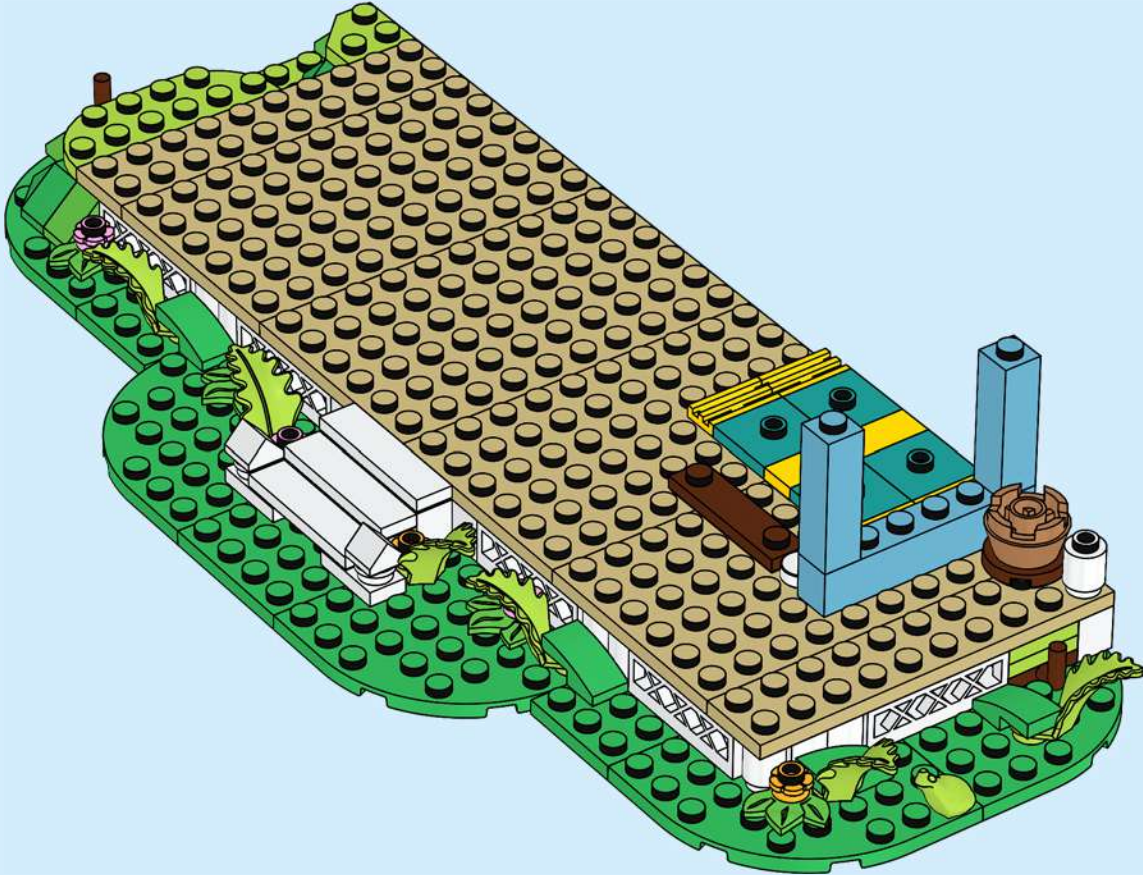

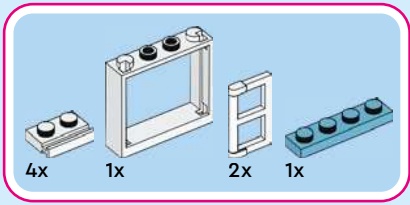

47

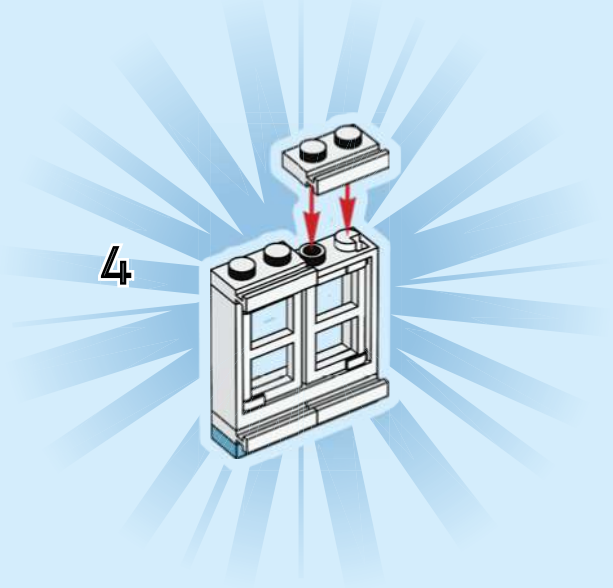
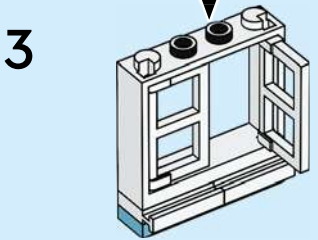
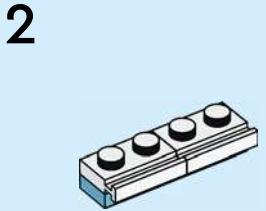
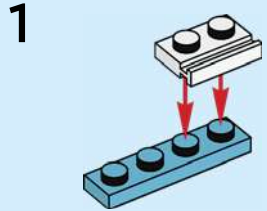
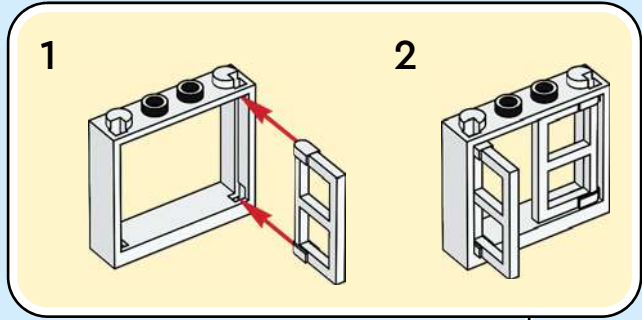

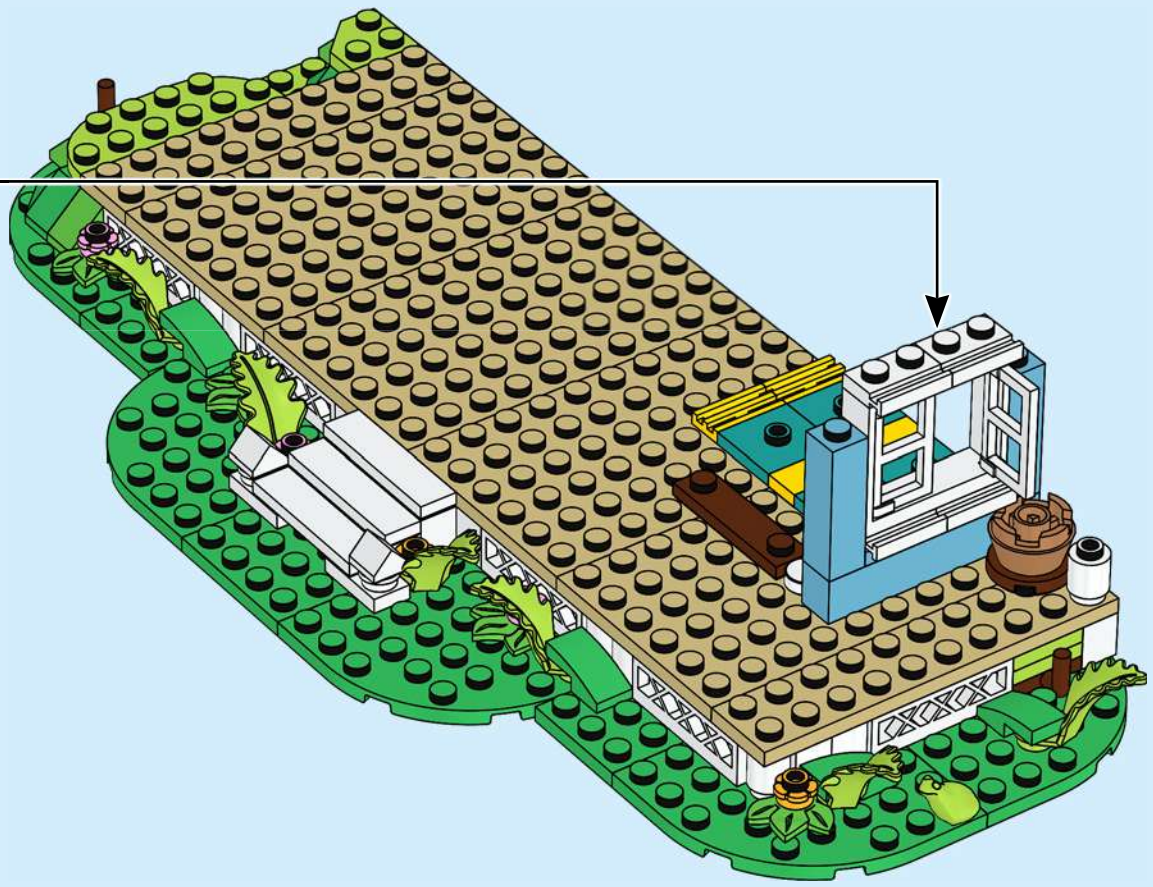



1x



1x

49

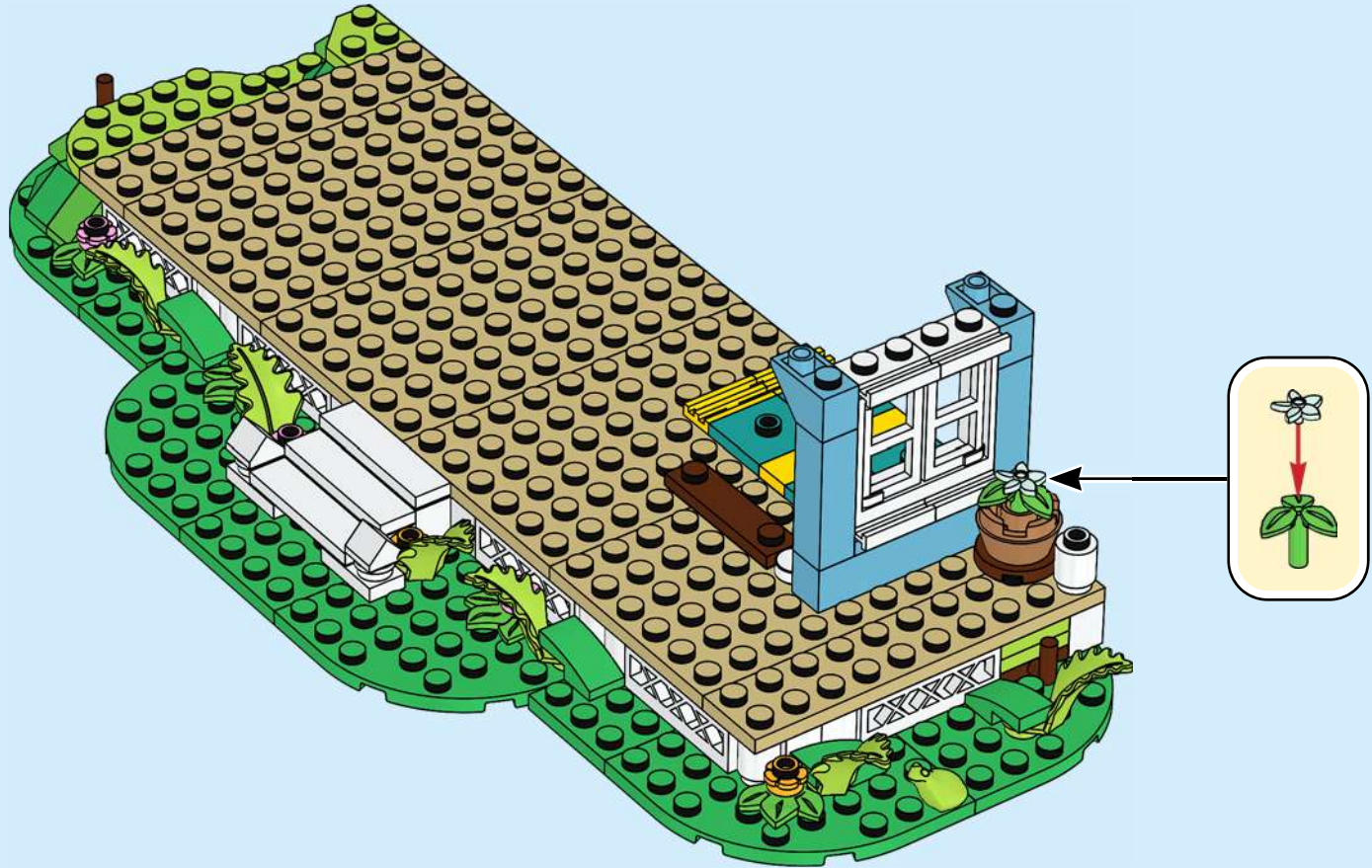

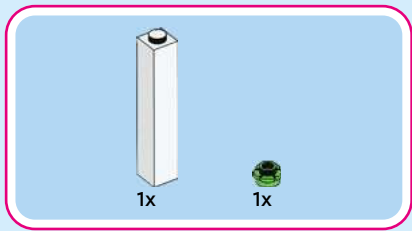

50

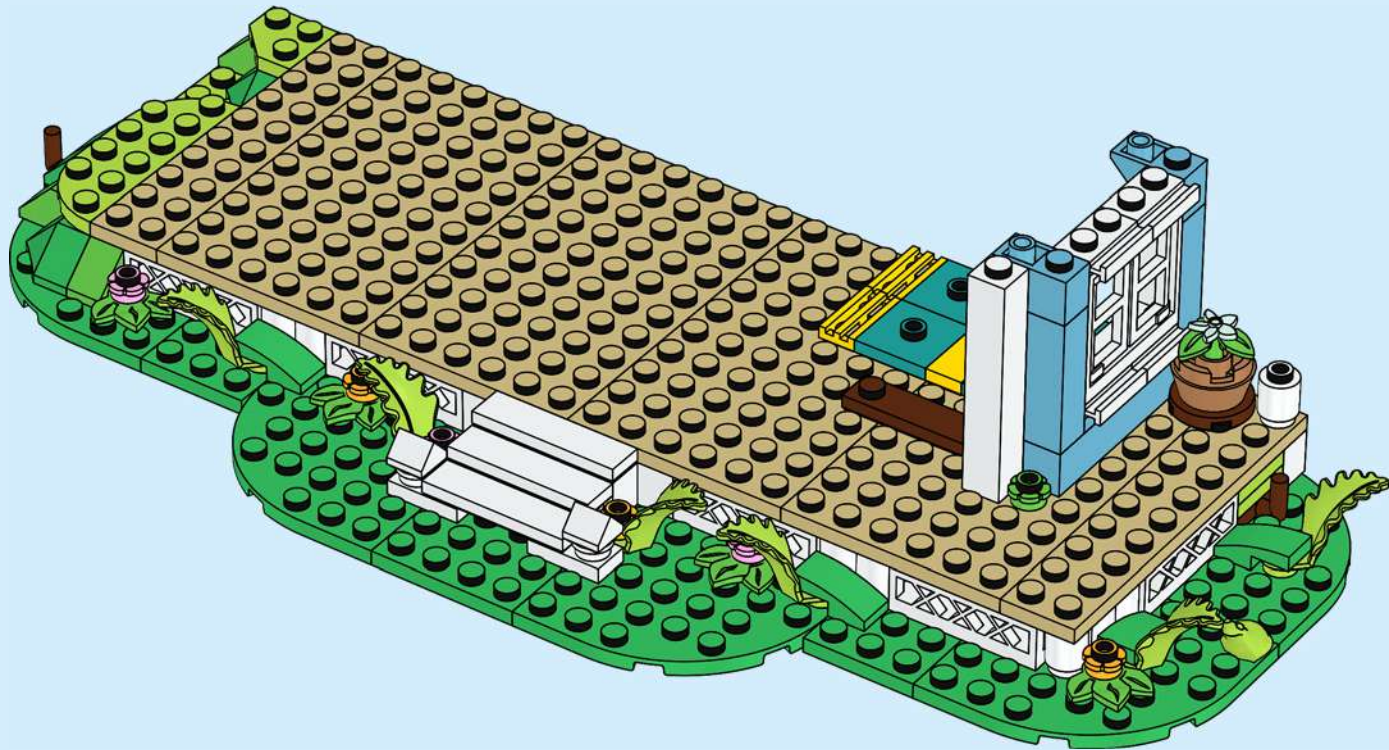

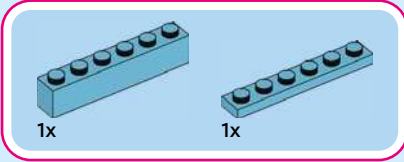
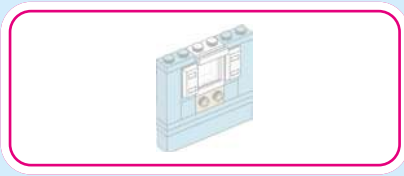

51

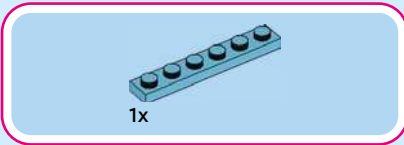
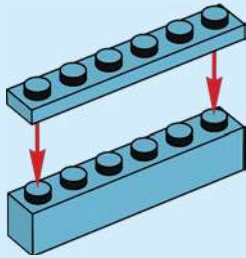

52

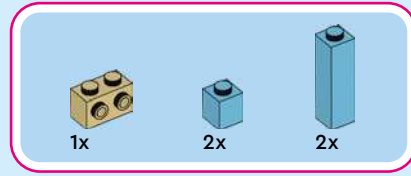
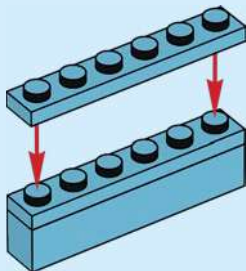

53

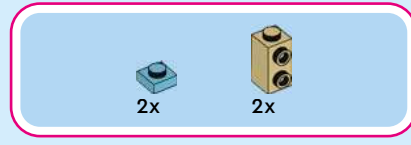
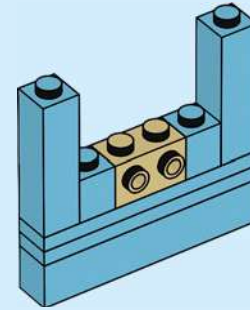

54

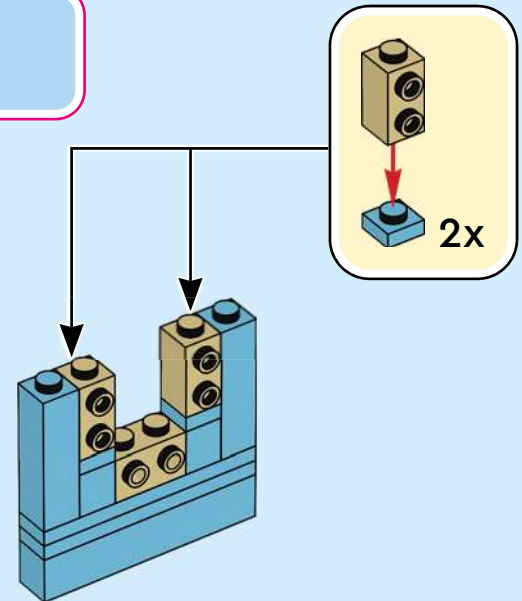

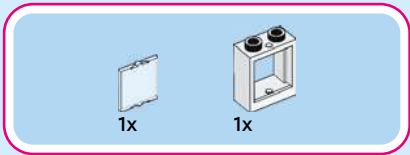

55

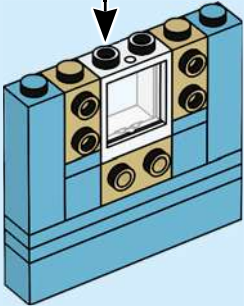
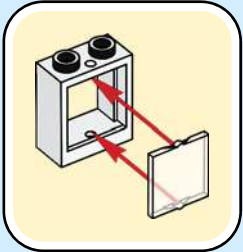

56

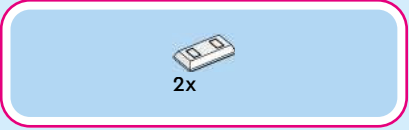
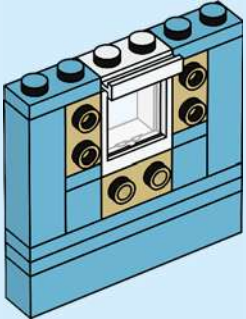

57

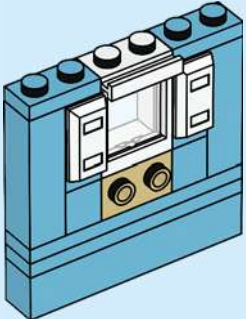

58

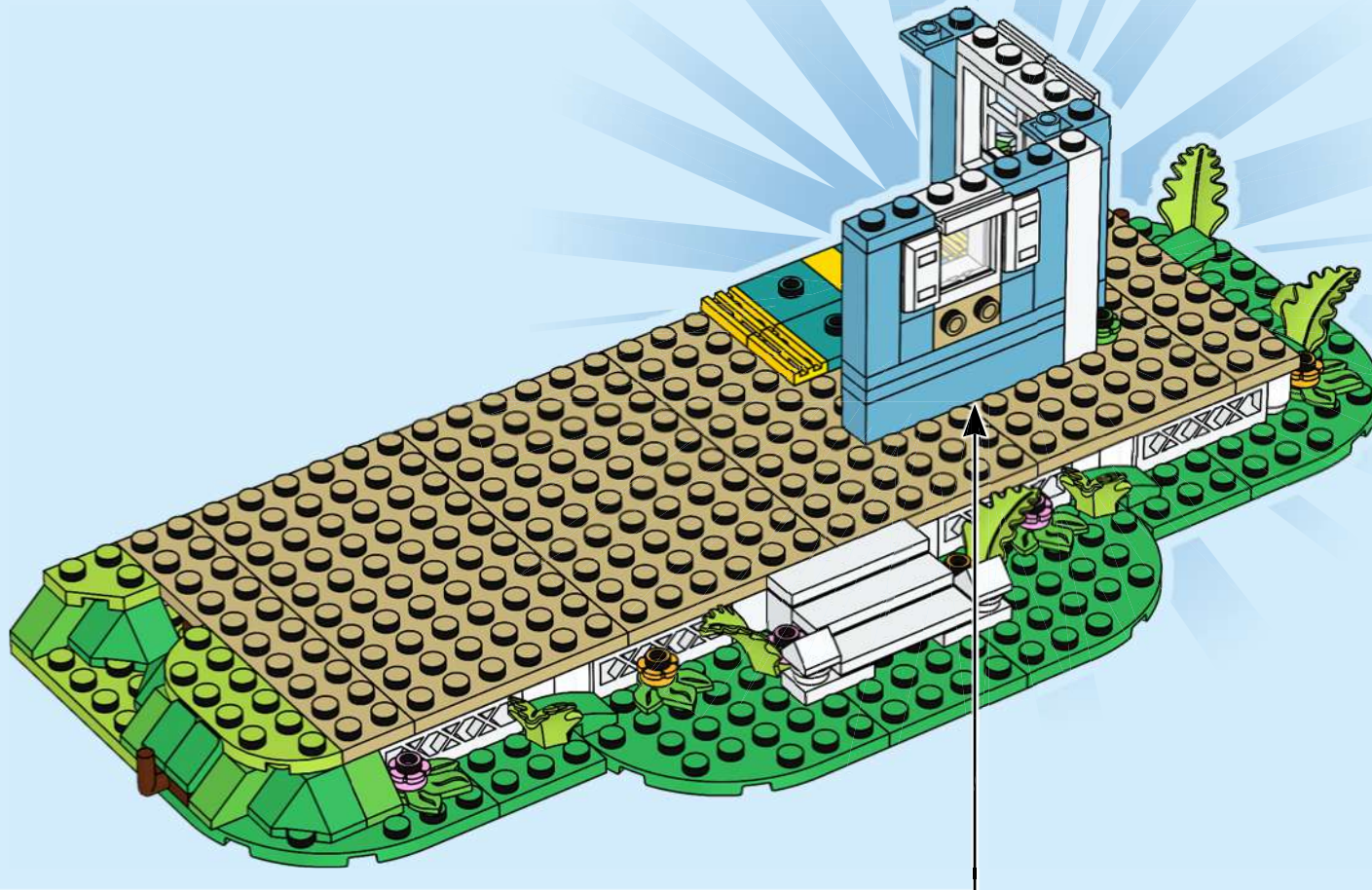



1x

59

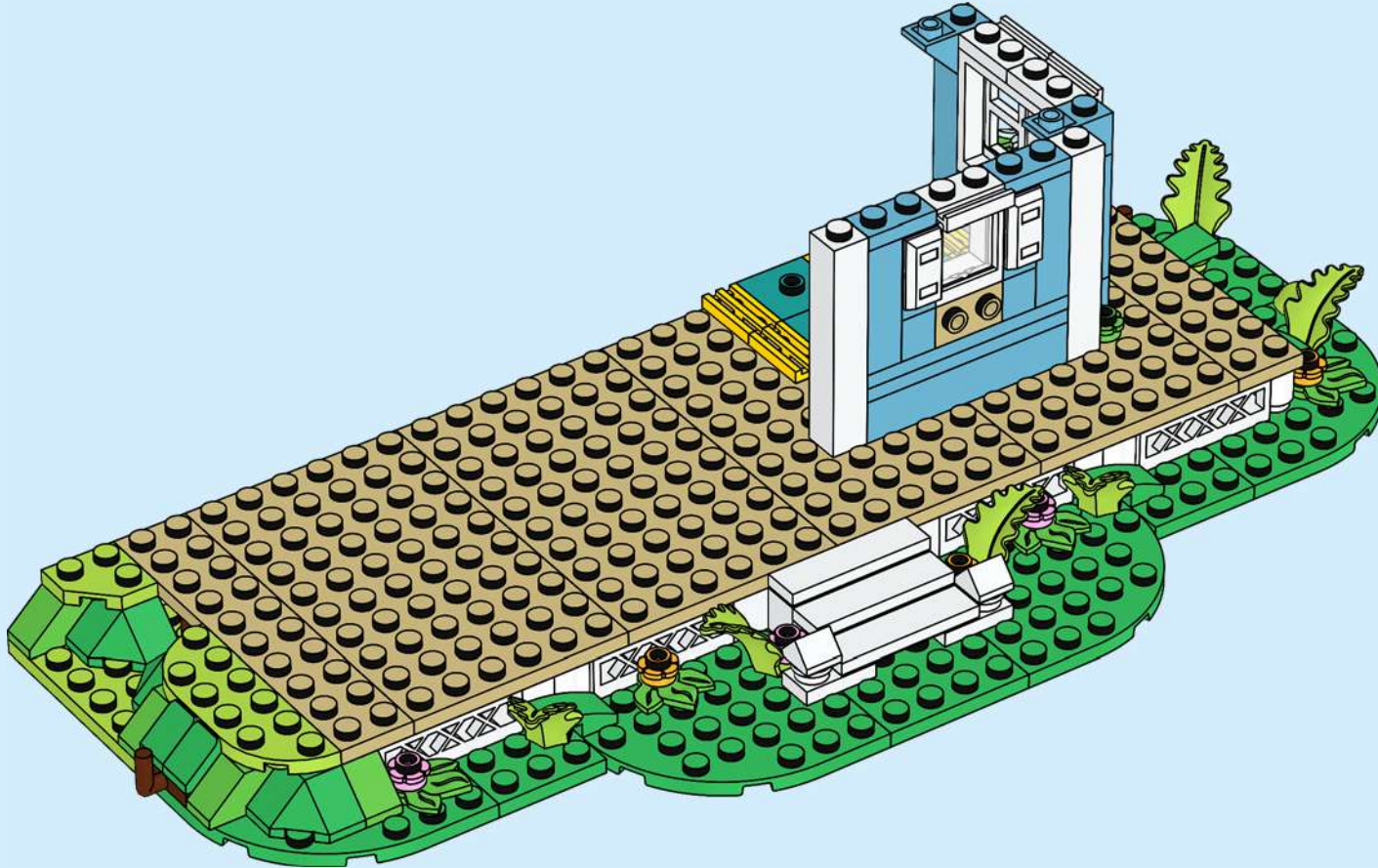

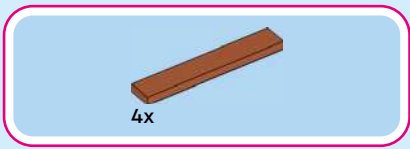

60

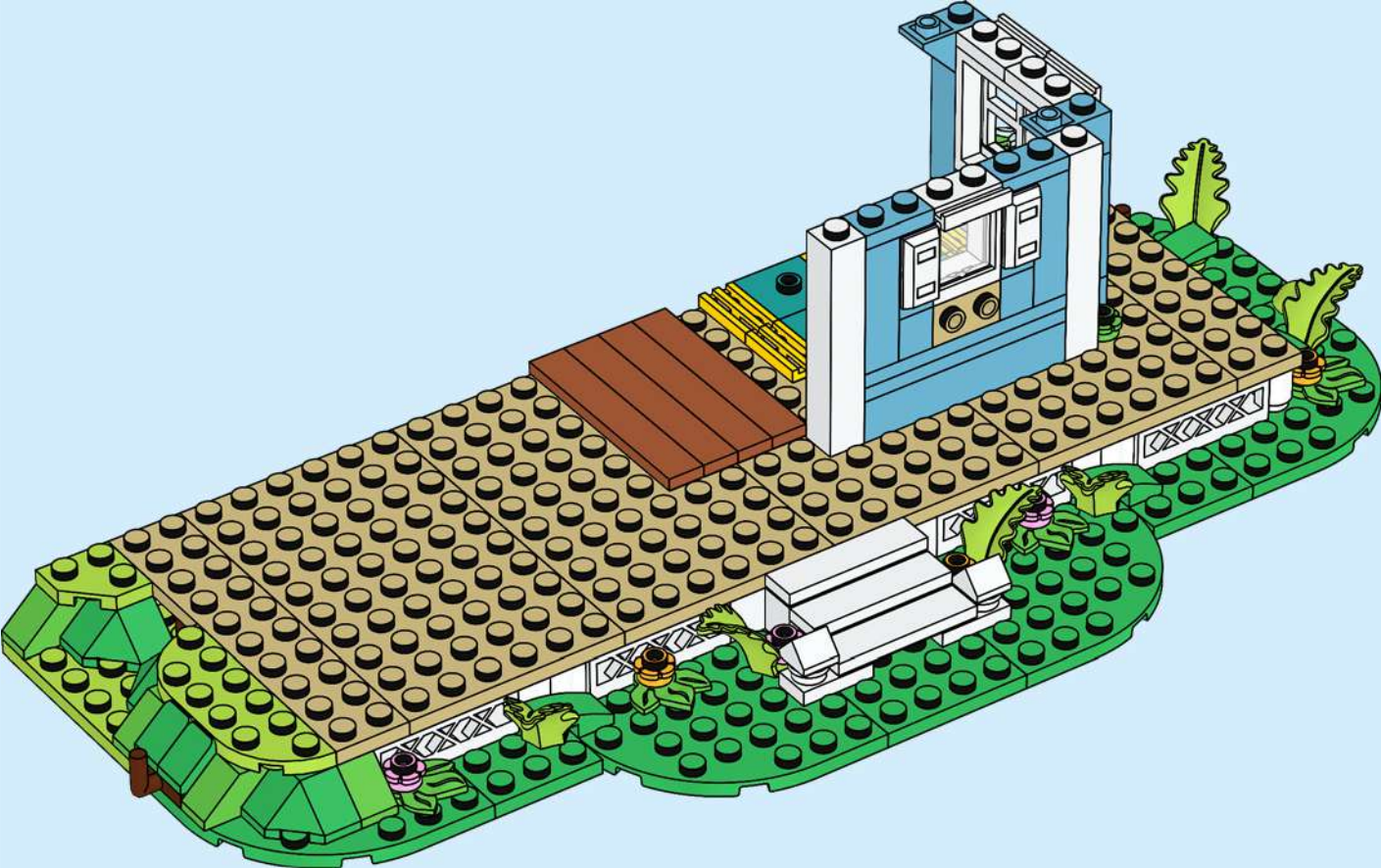

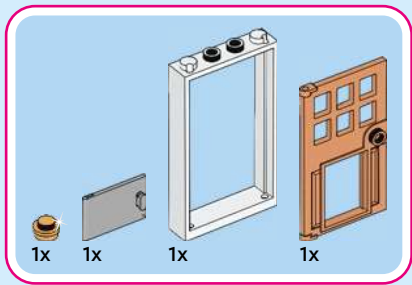

61

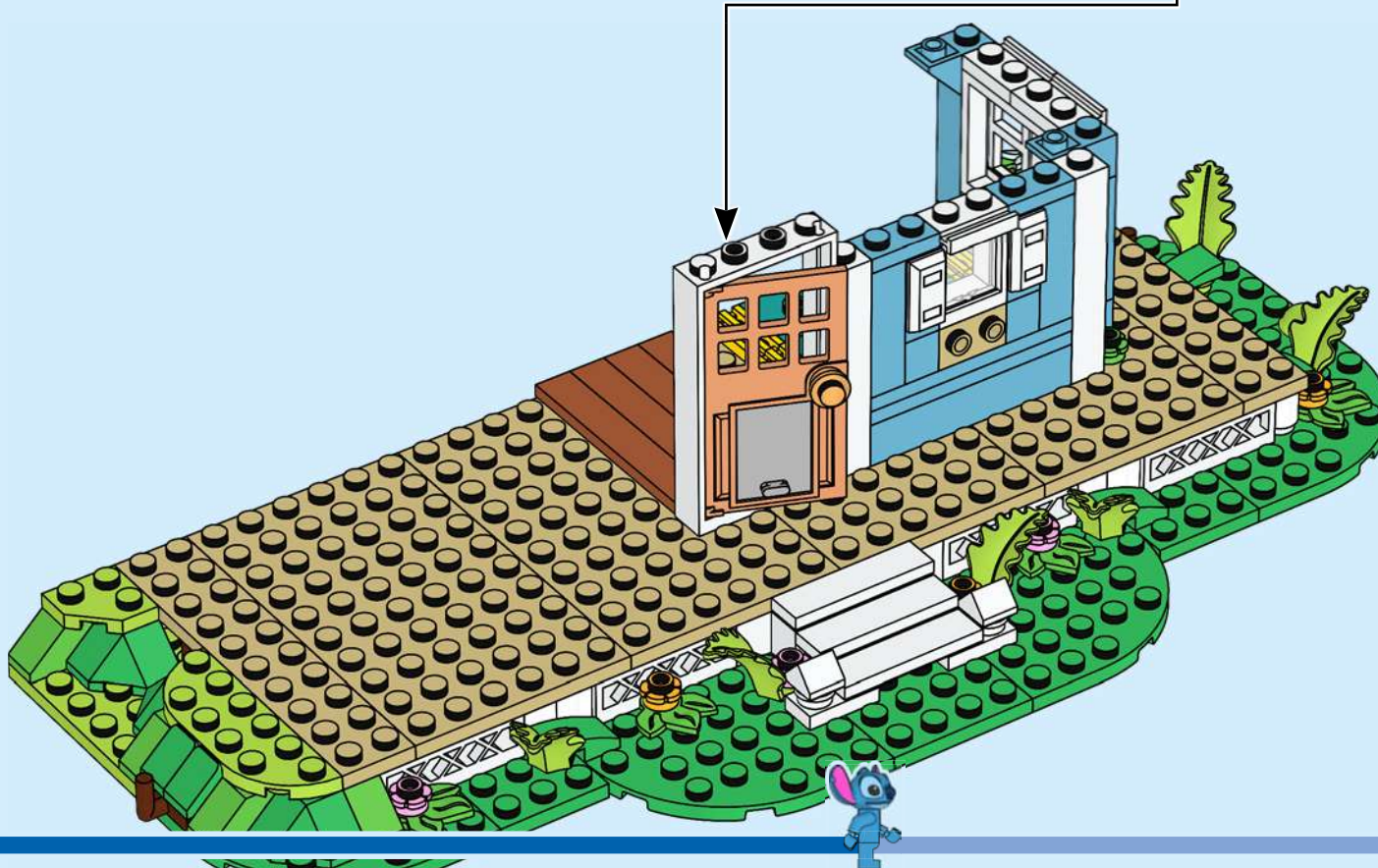
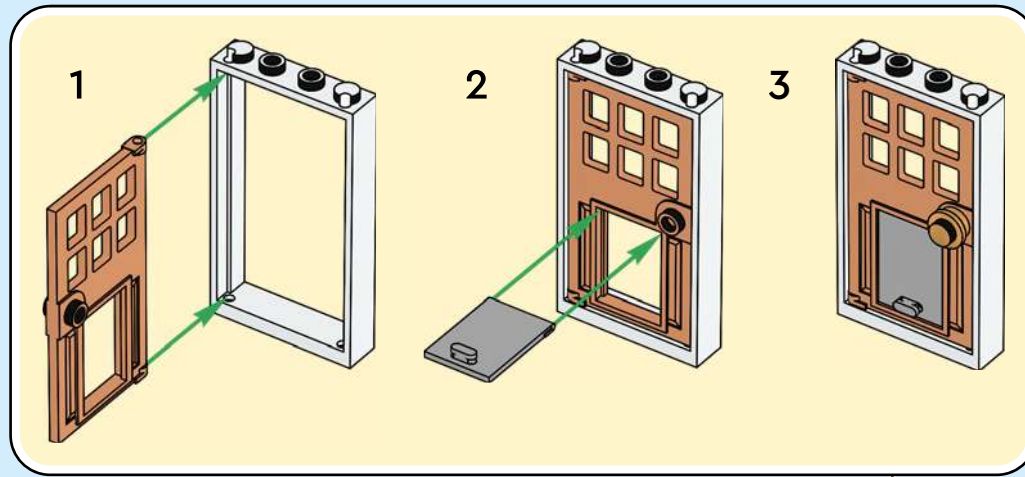

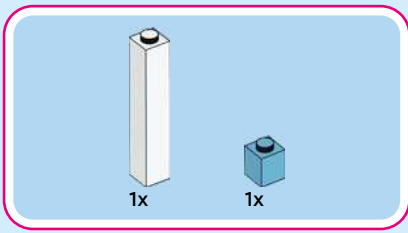

62

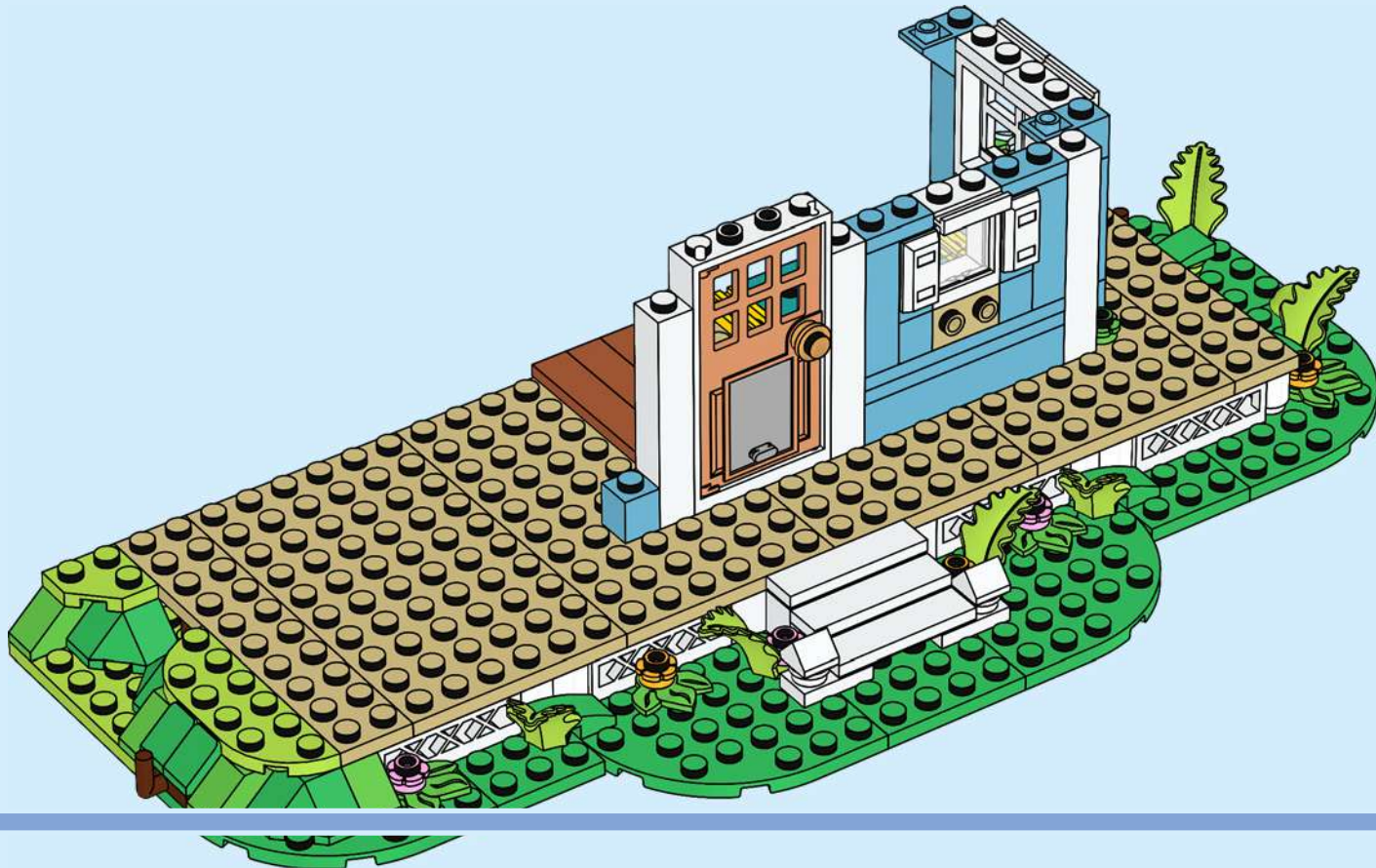

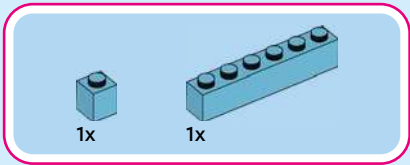

63

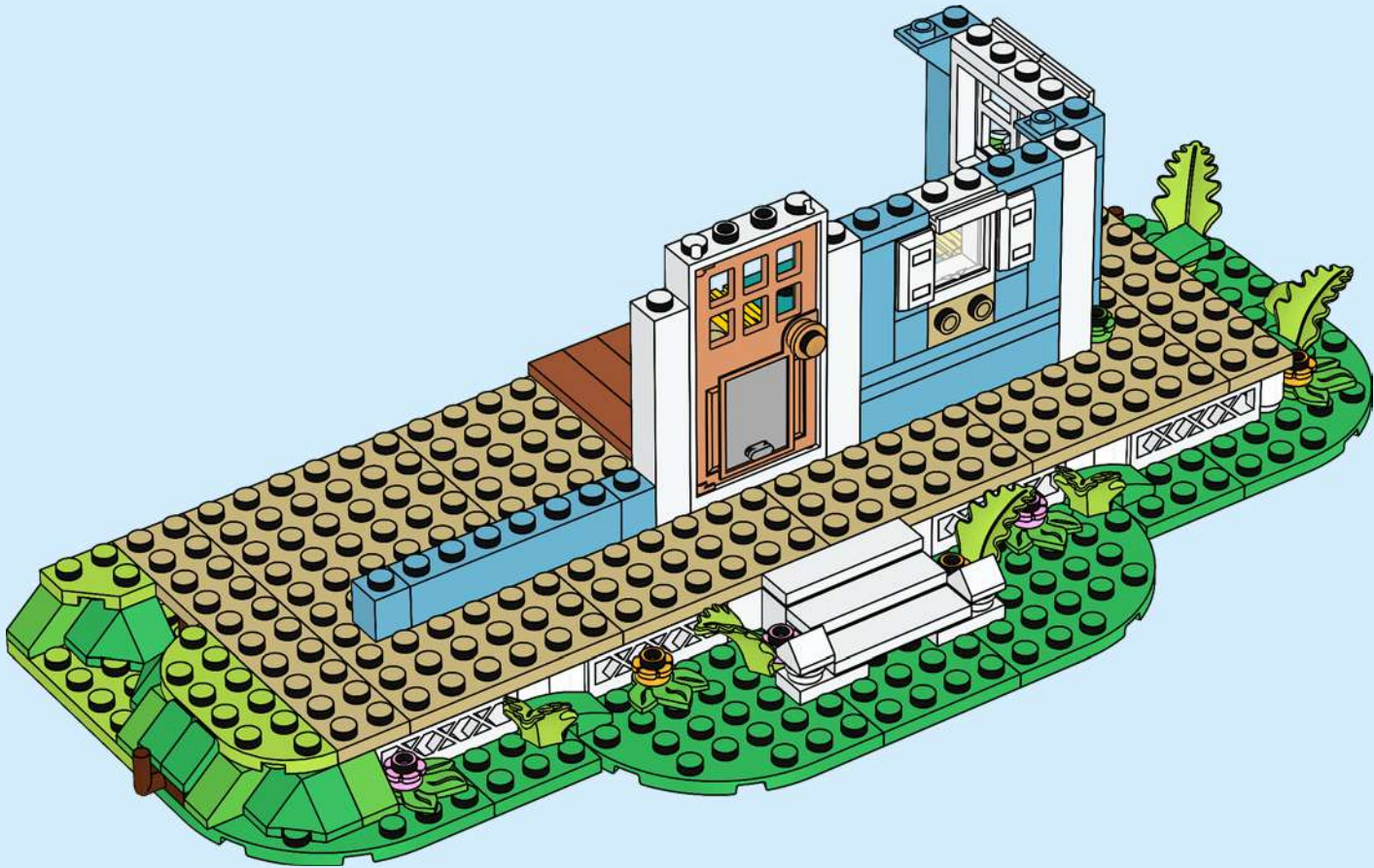

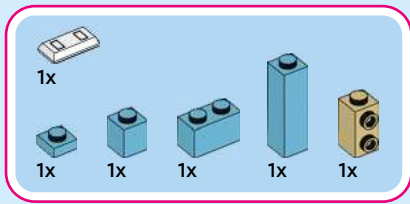

64

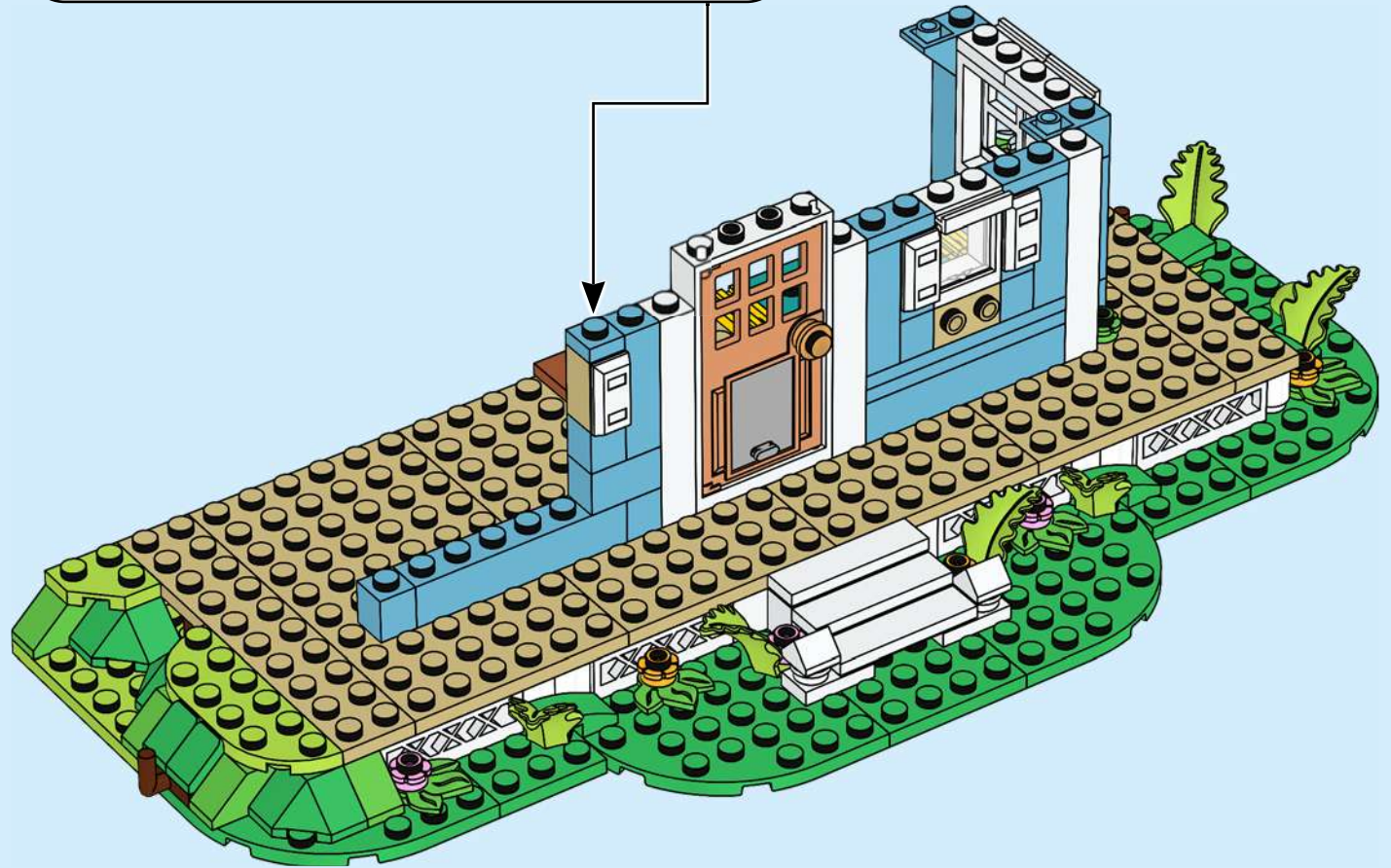
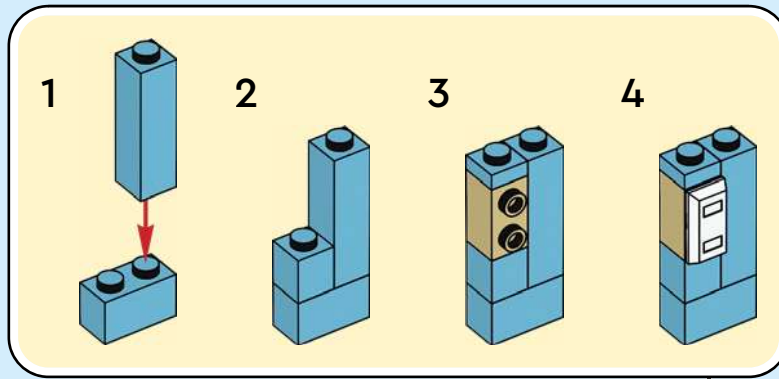



1x



2x

65

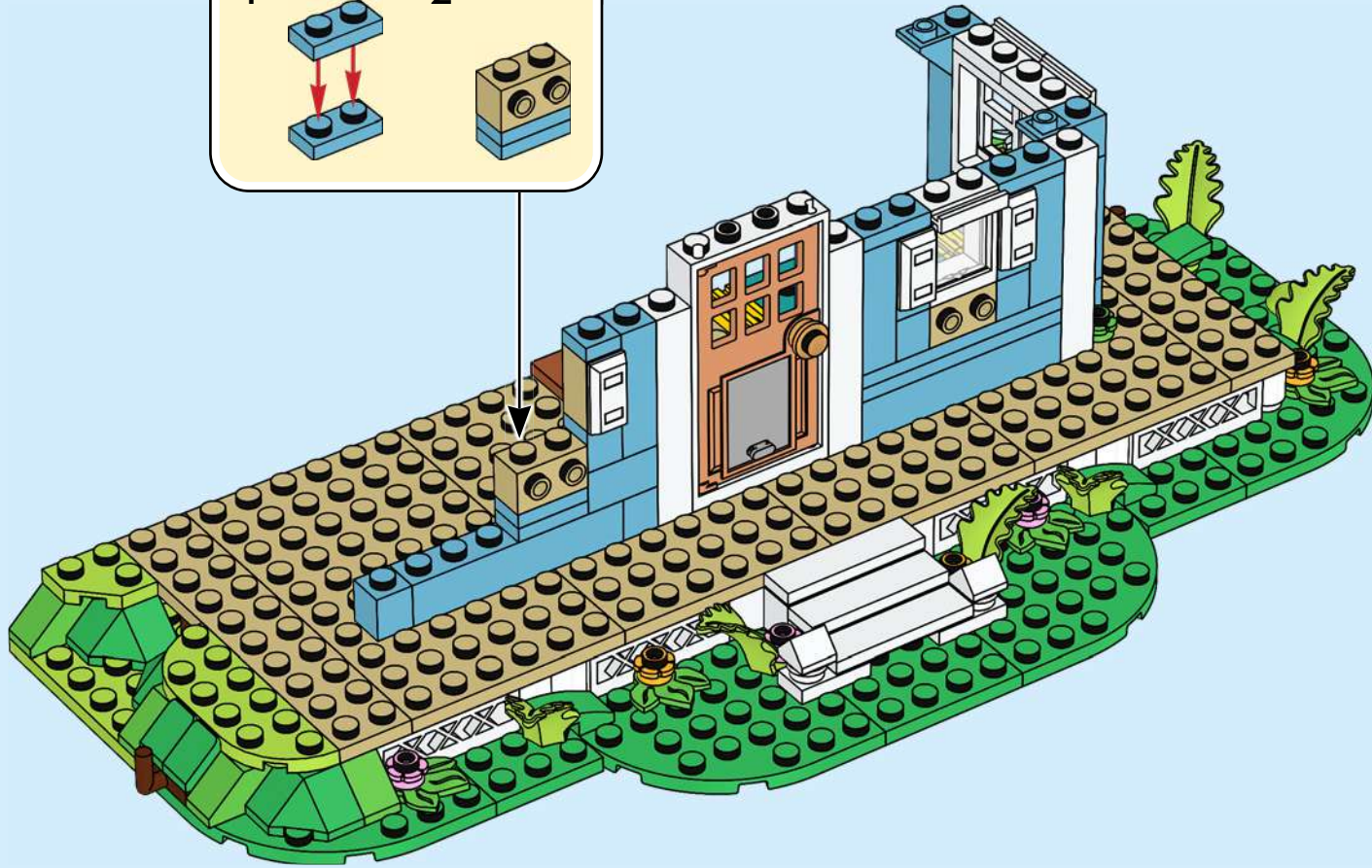
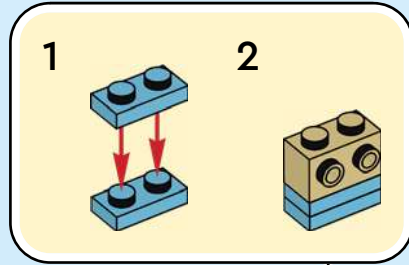



2x

66

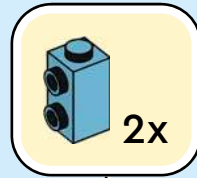

2x

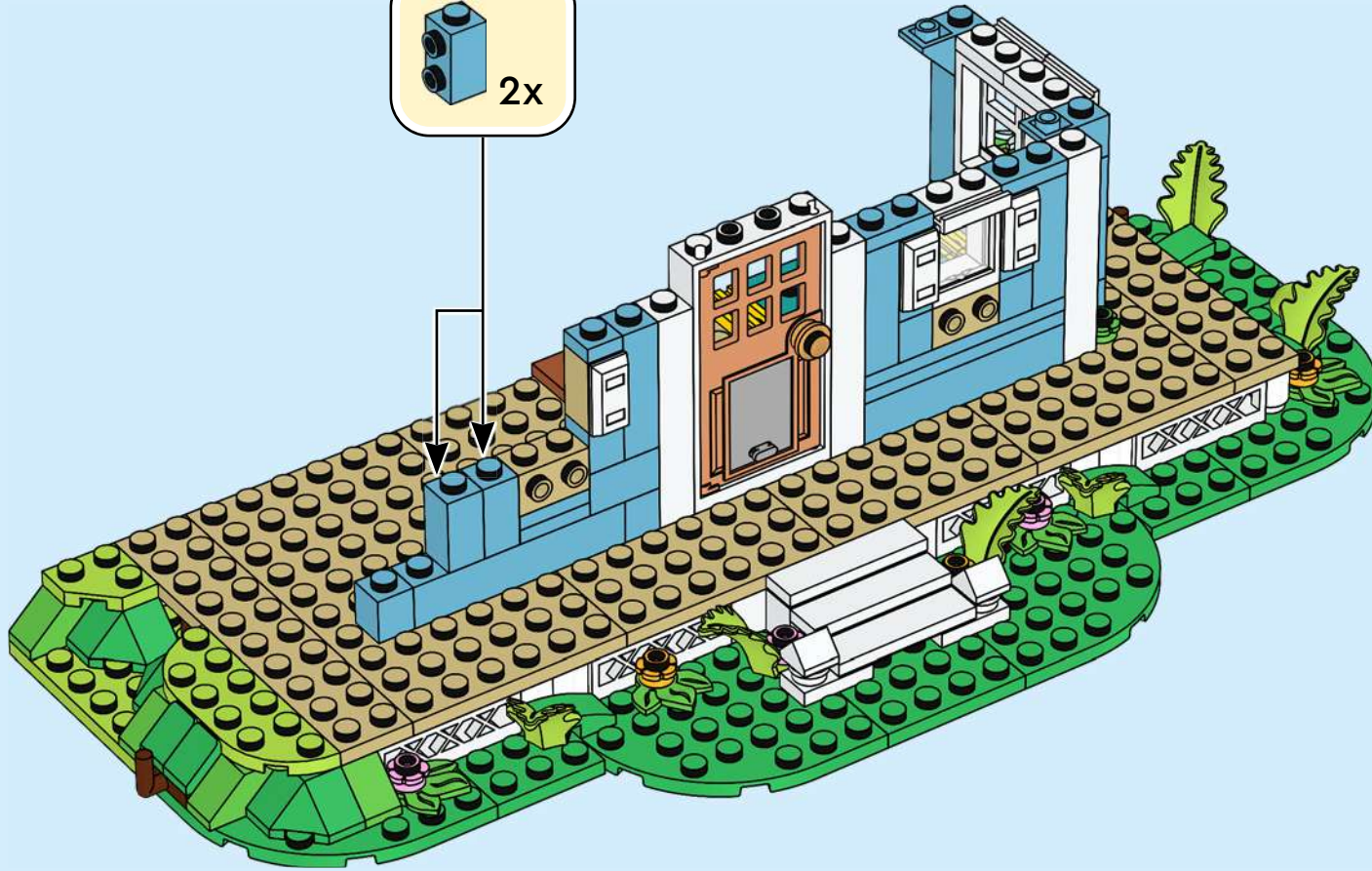

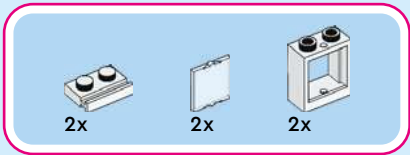

67

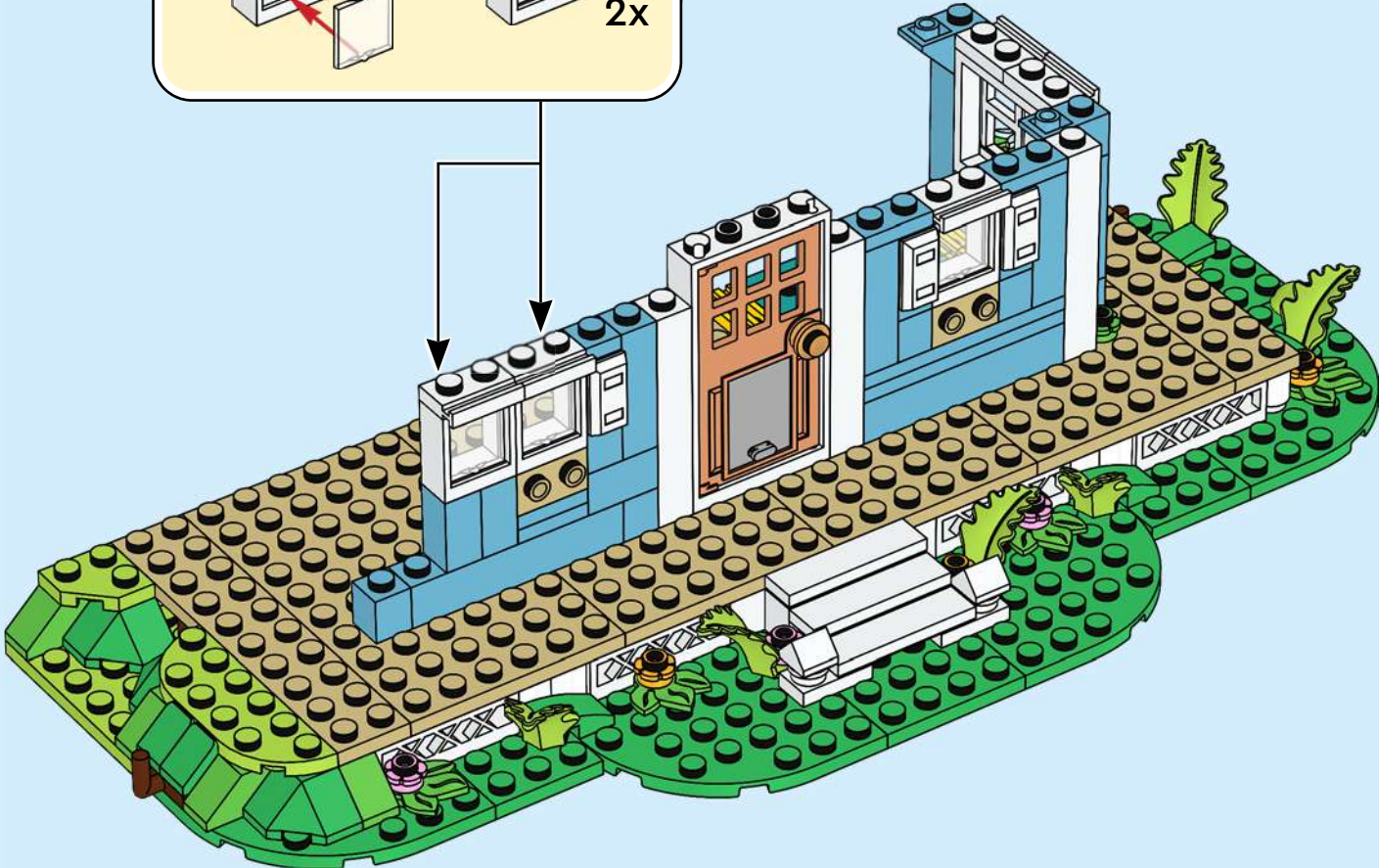
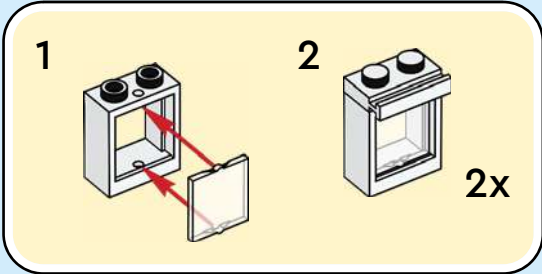

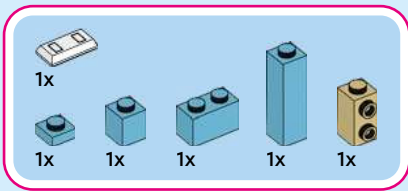

68

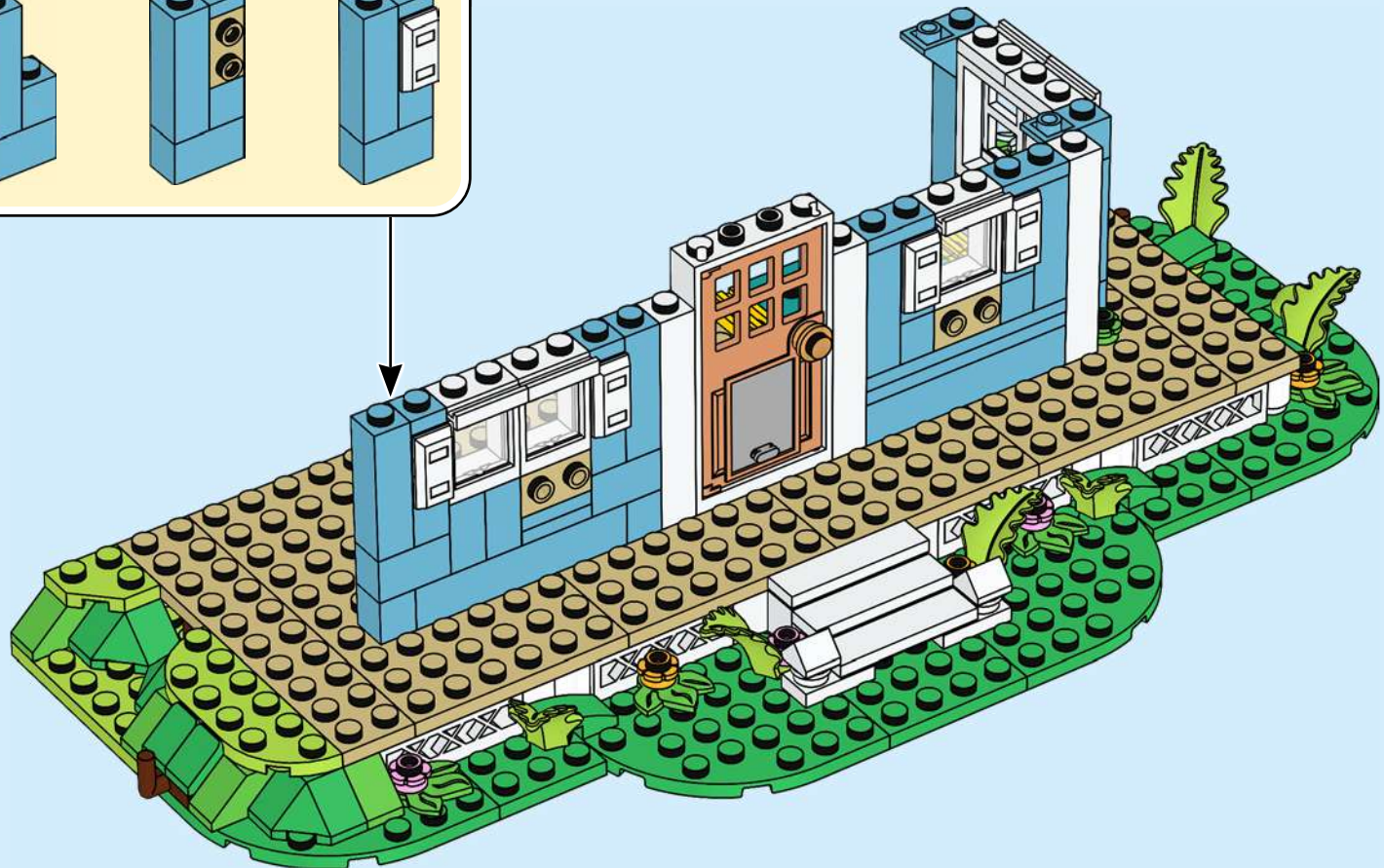
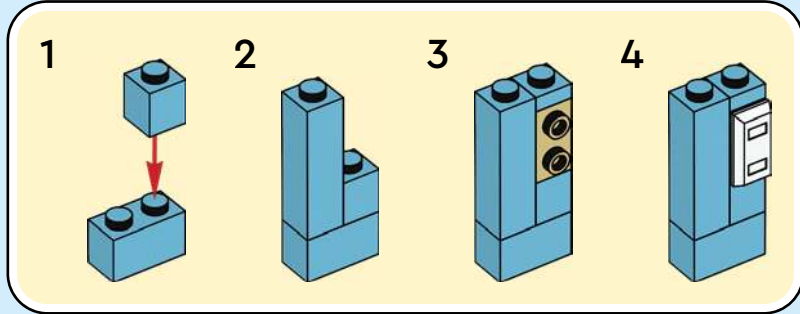

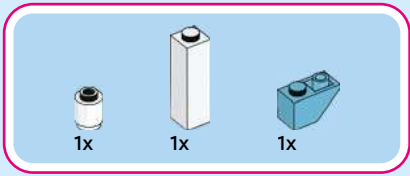

69

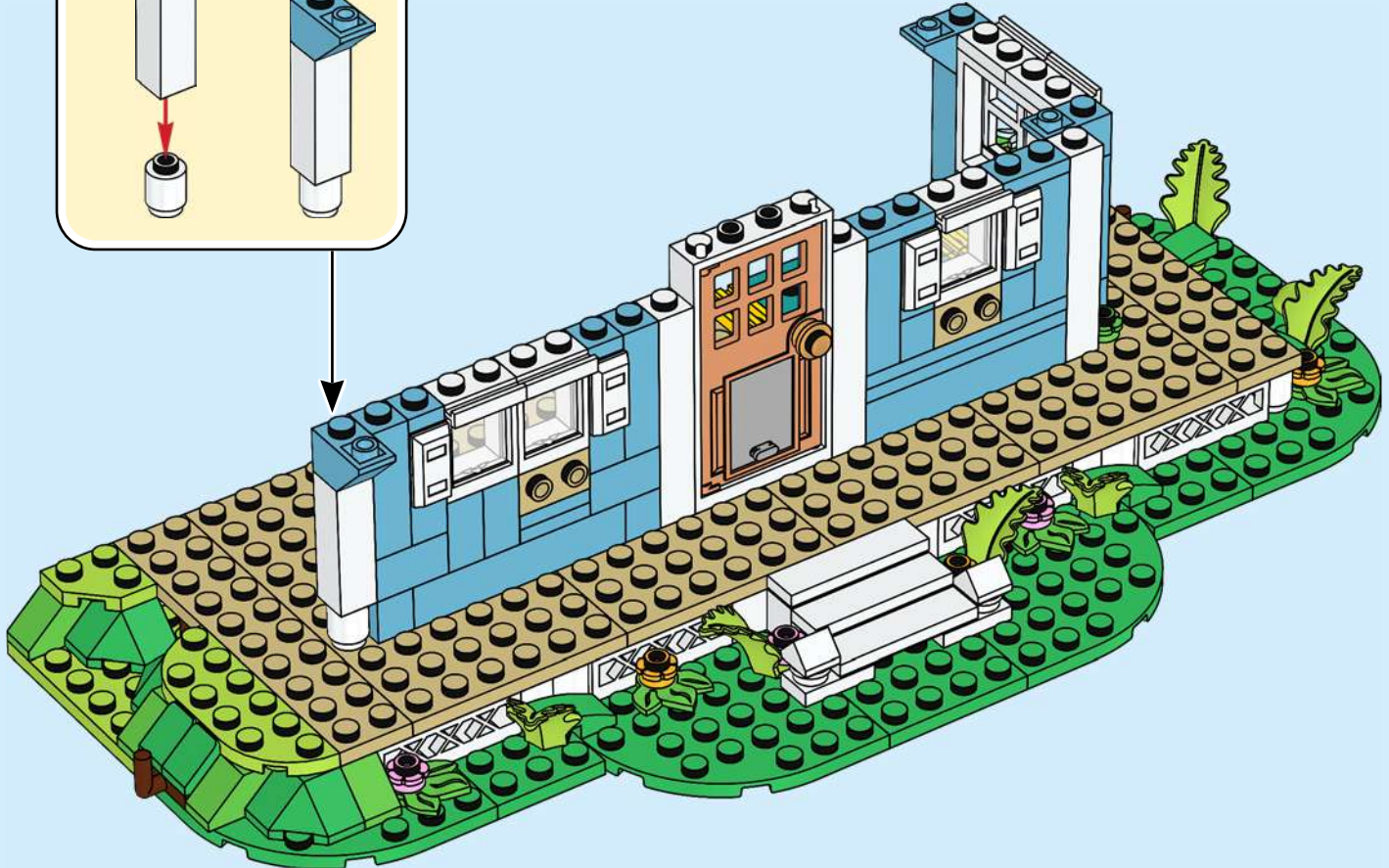
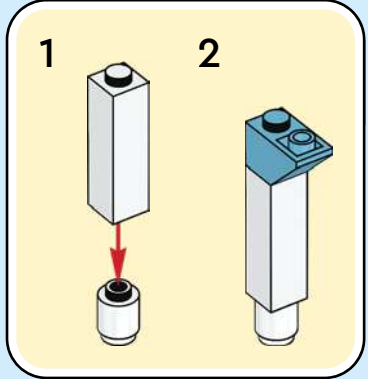

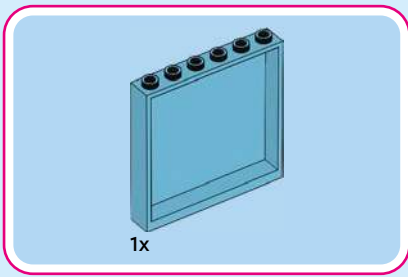

70

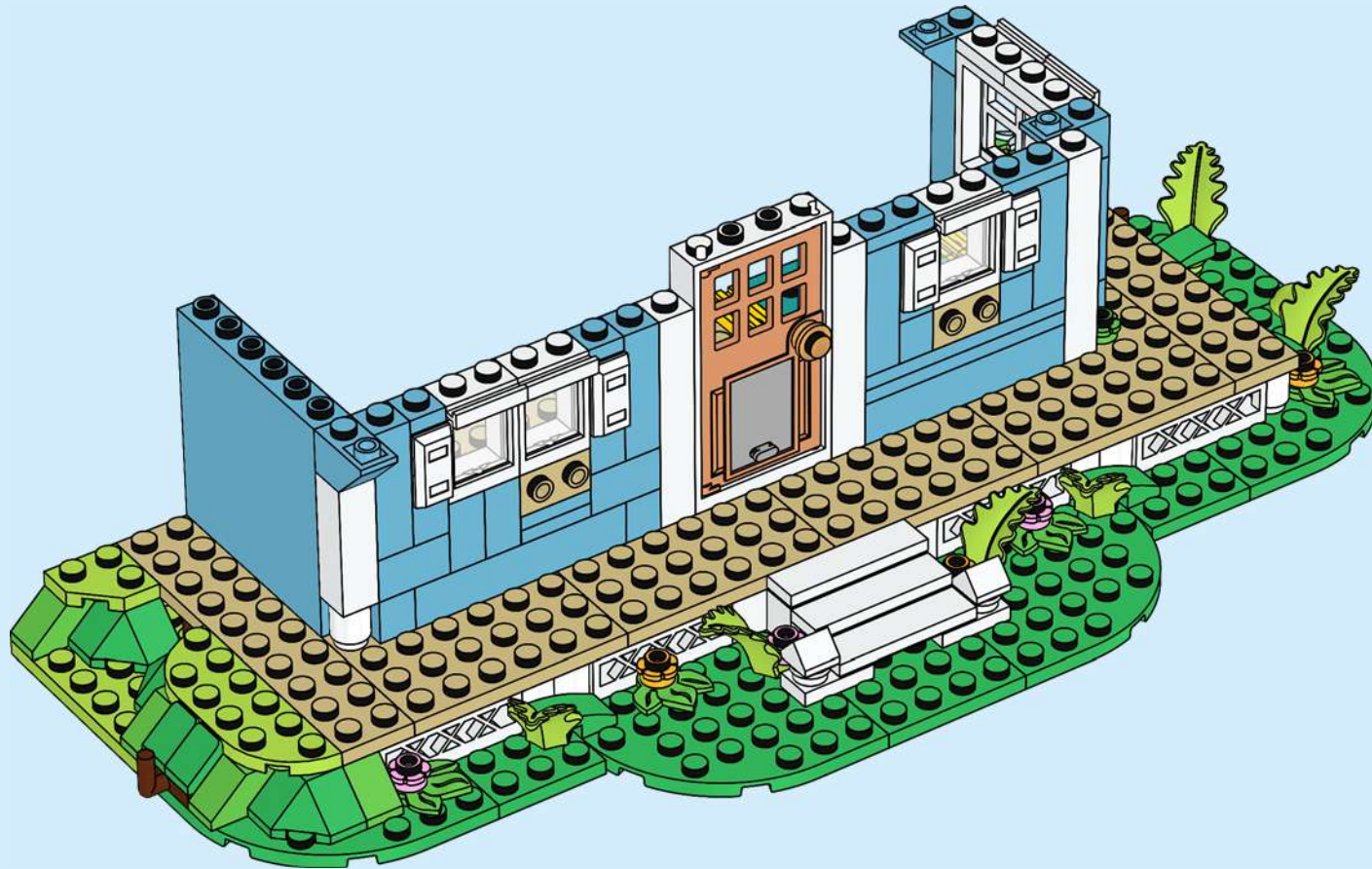



1x



1x

71

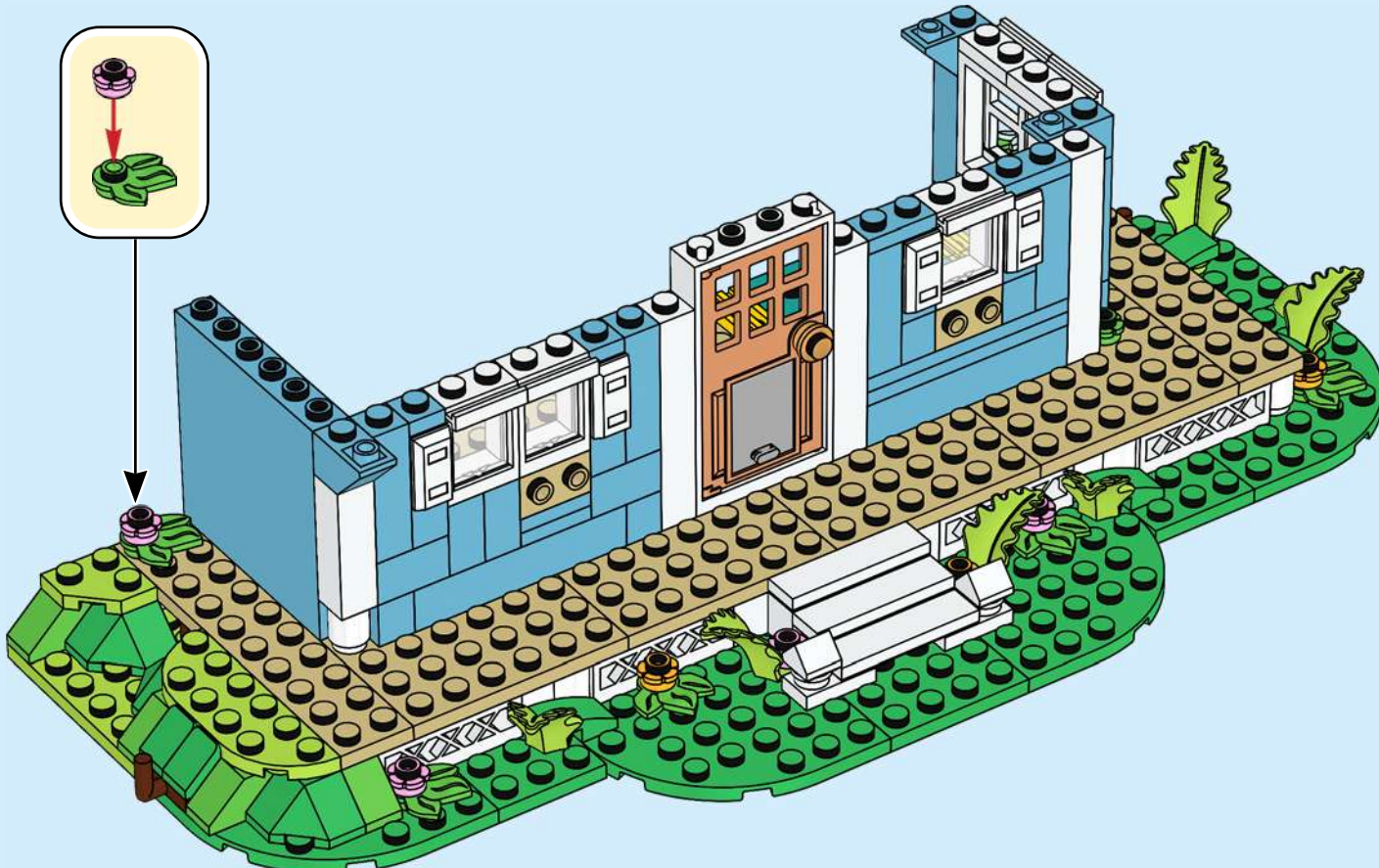

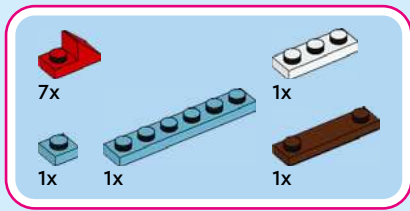

72

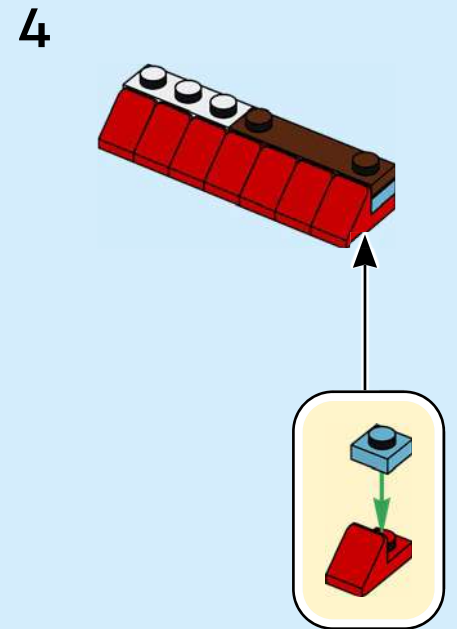
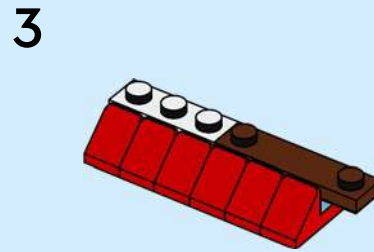
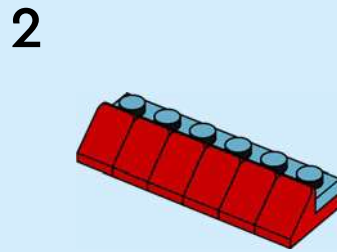
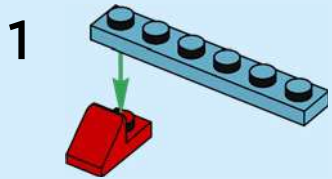

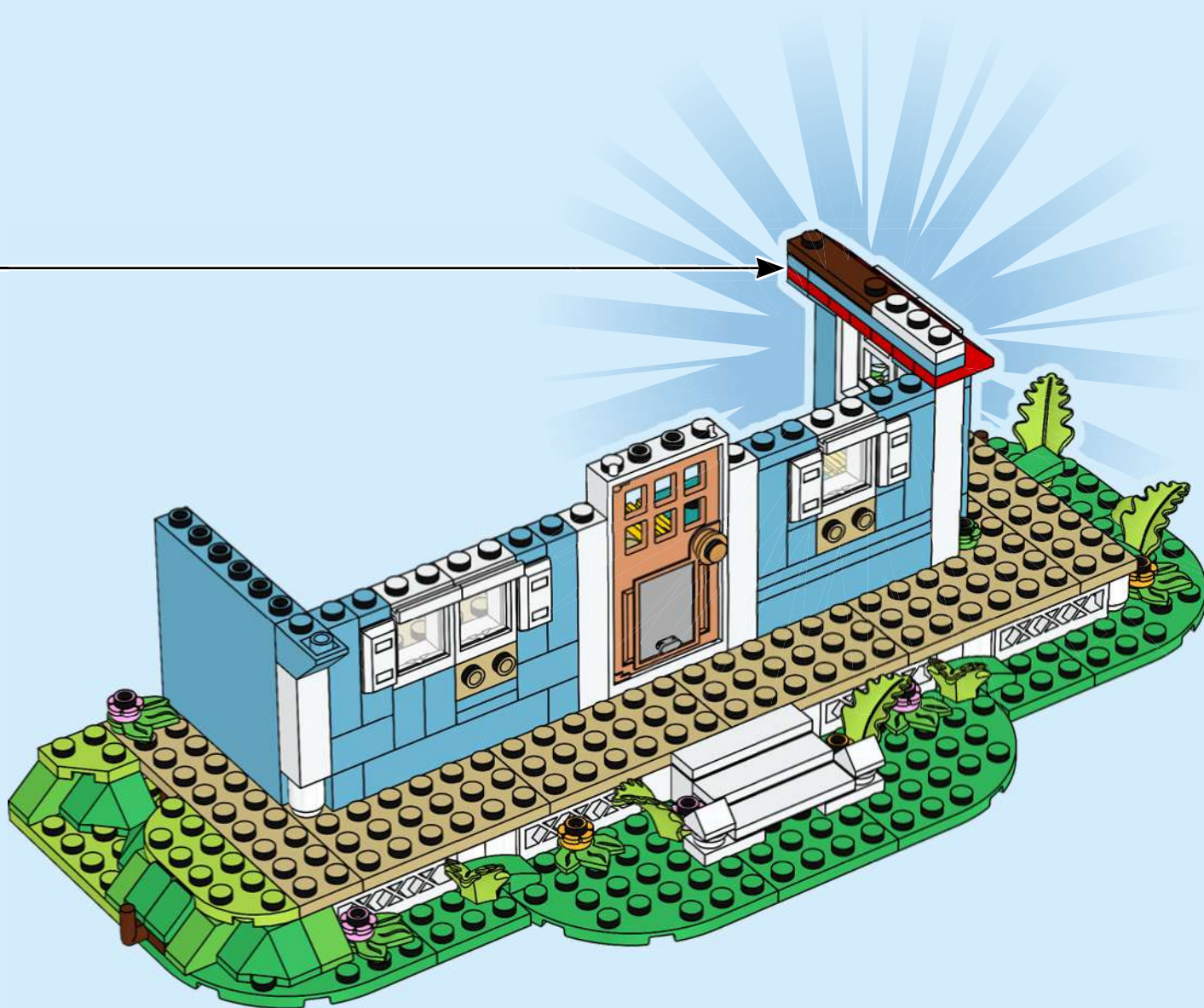

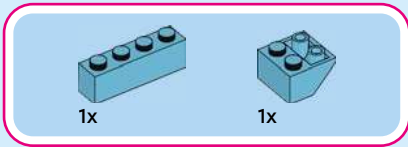

73

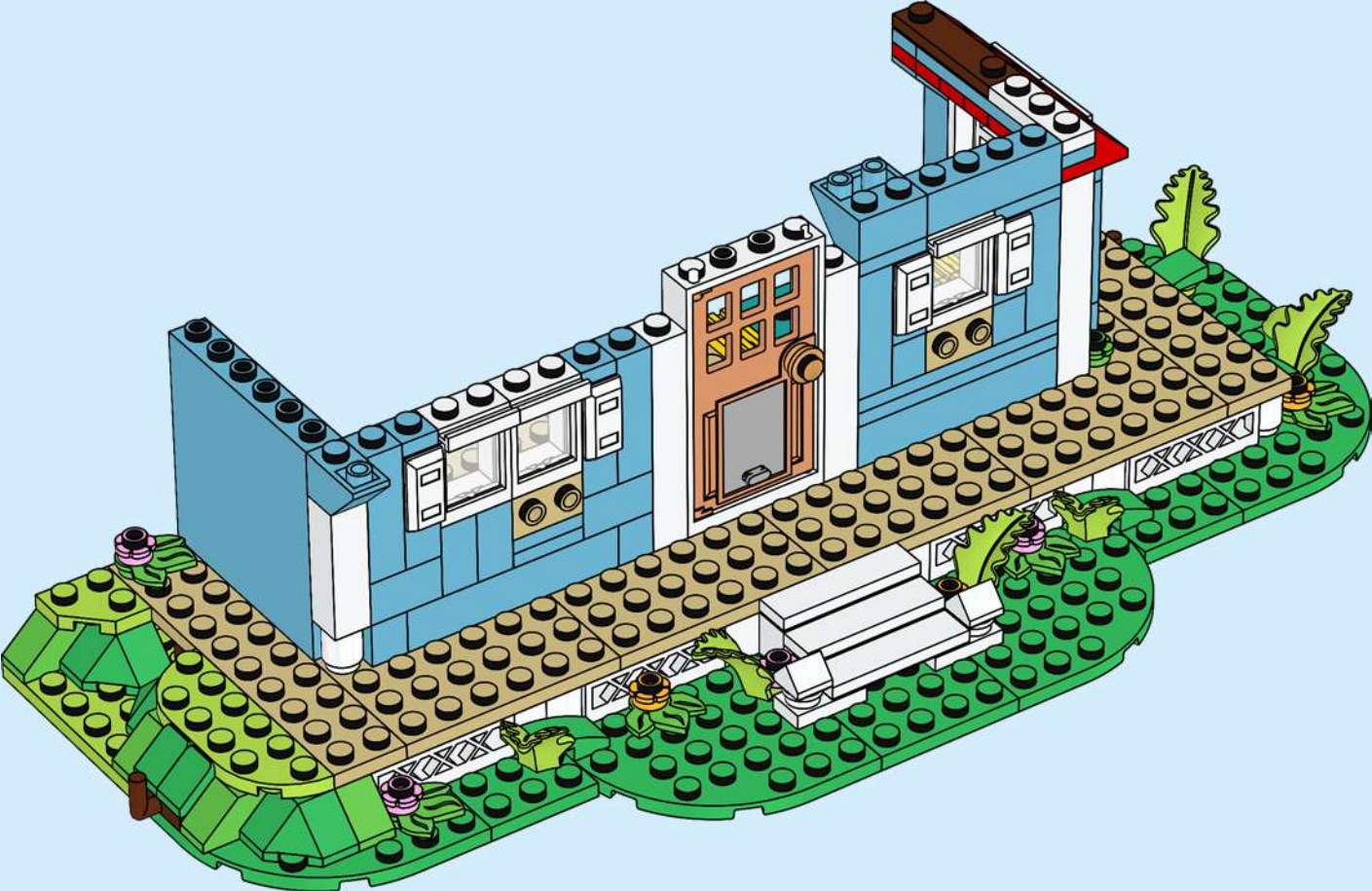



2x

74

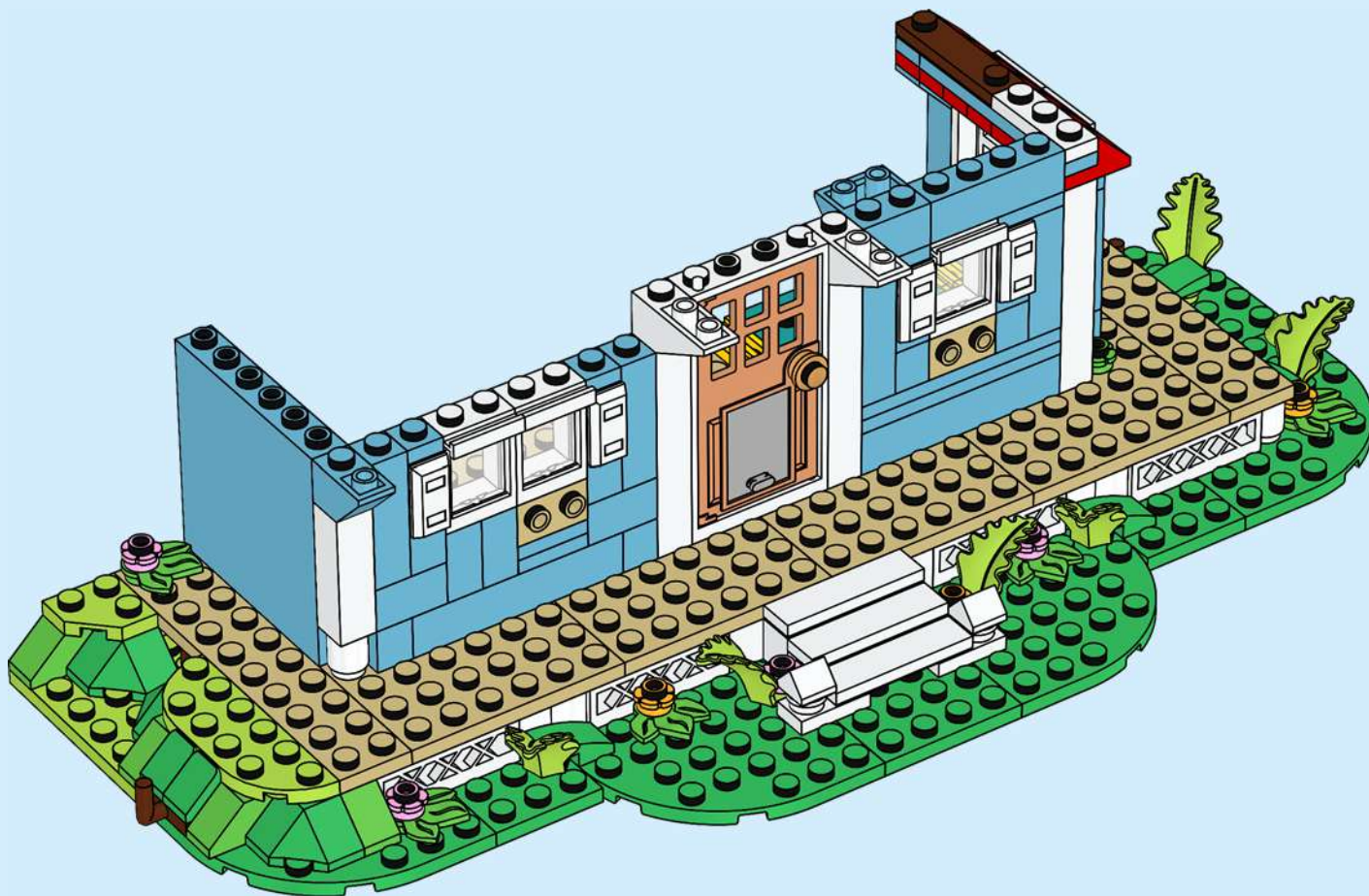

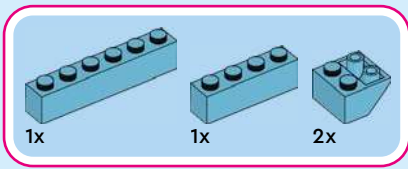

75

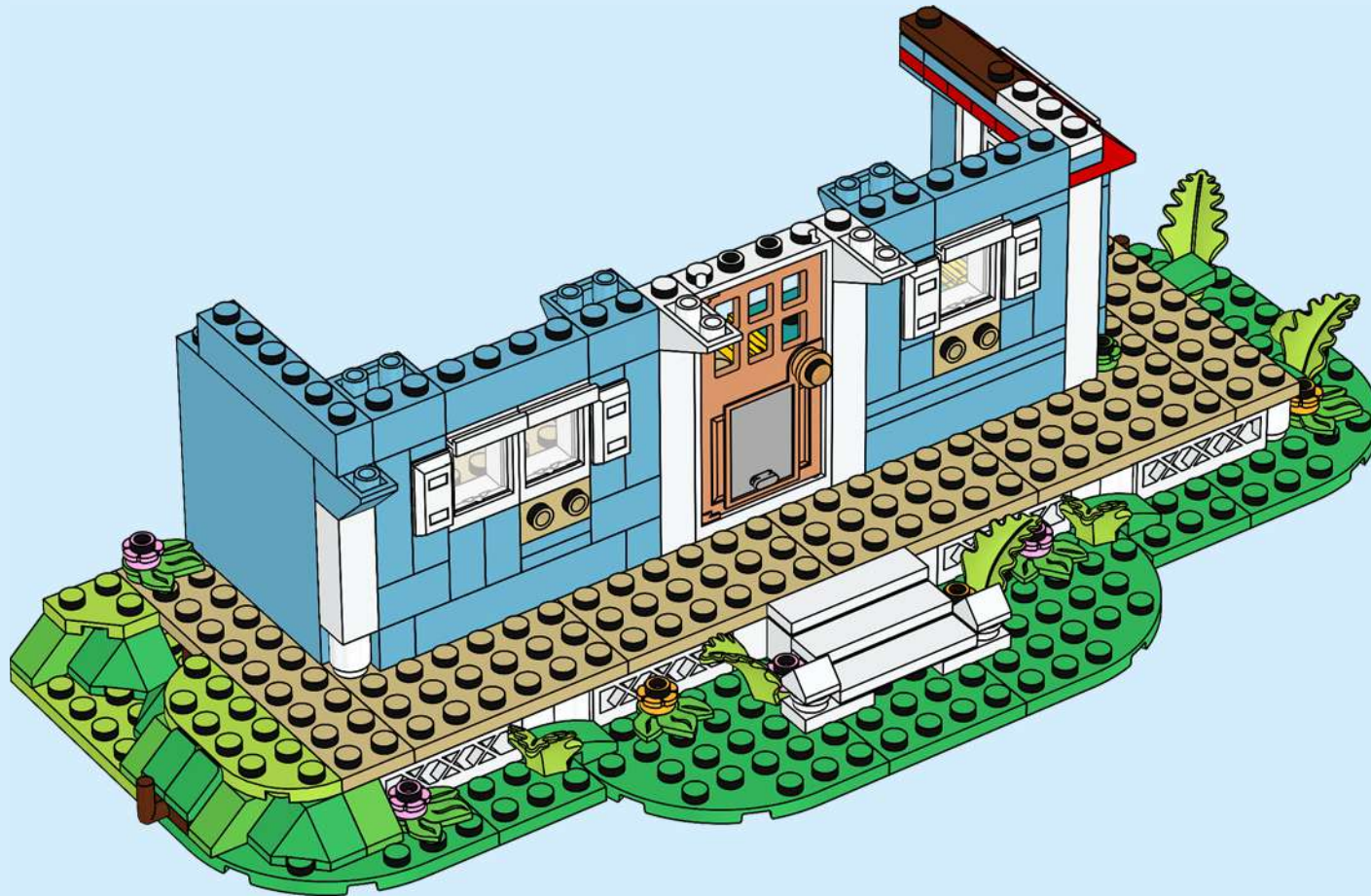

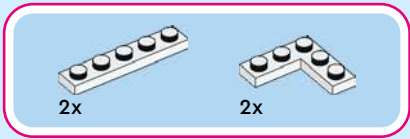

76

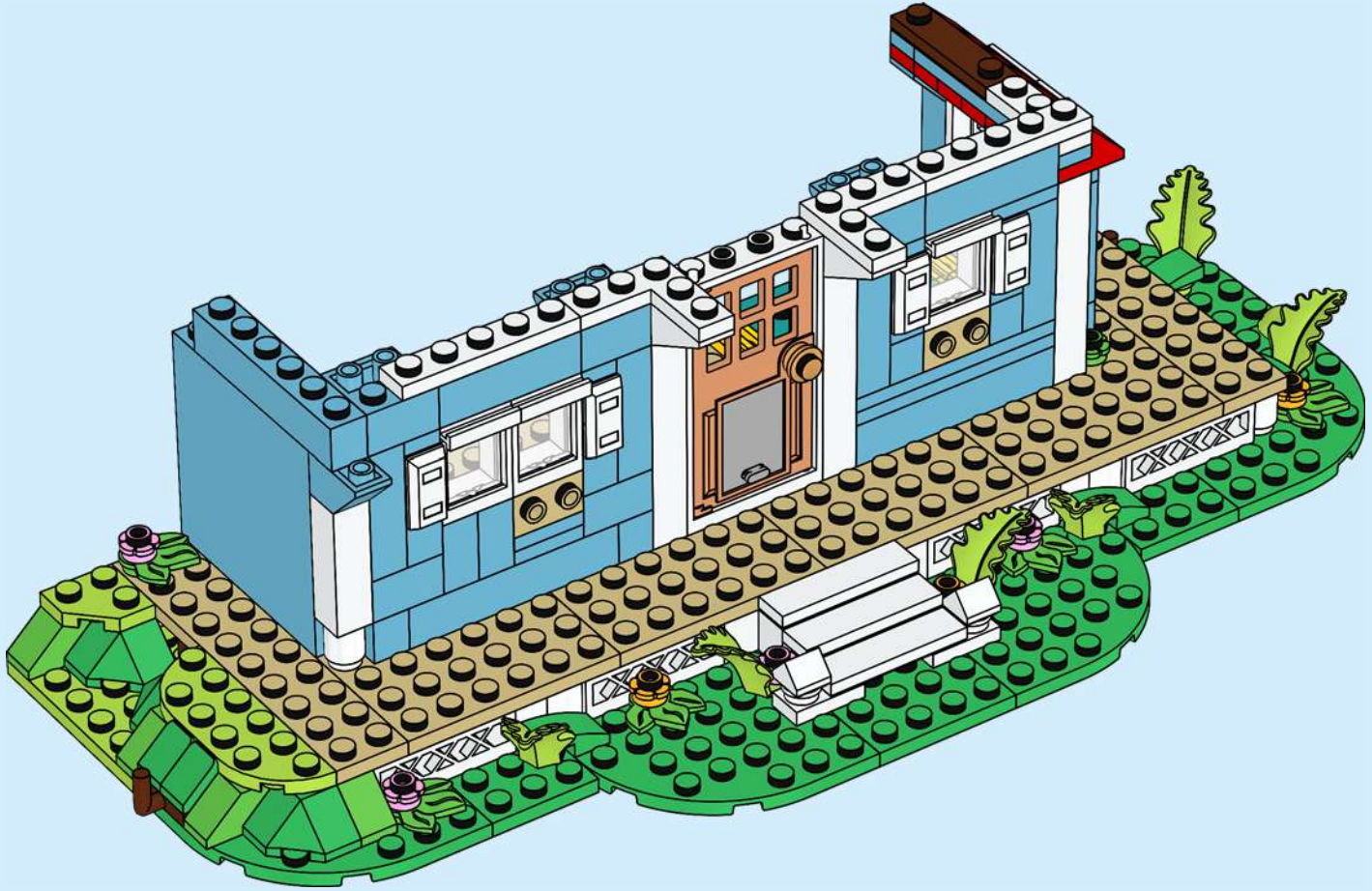

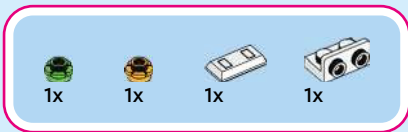

77

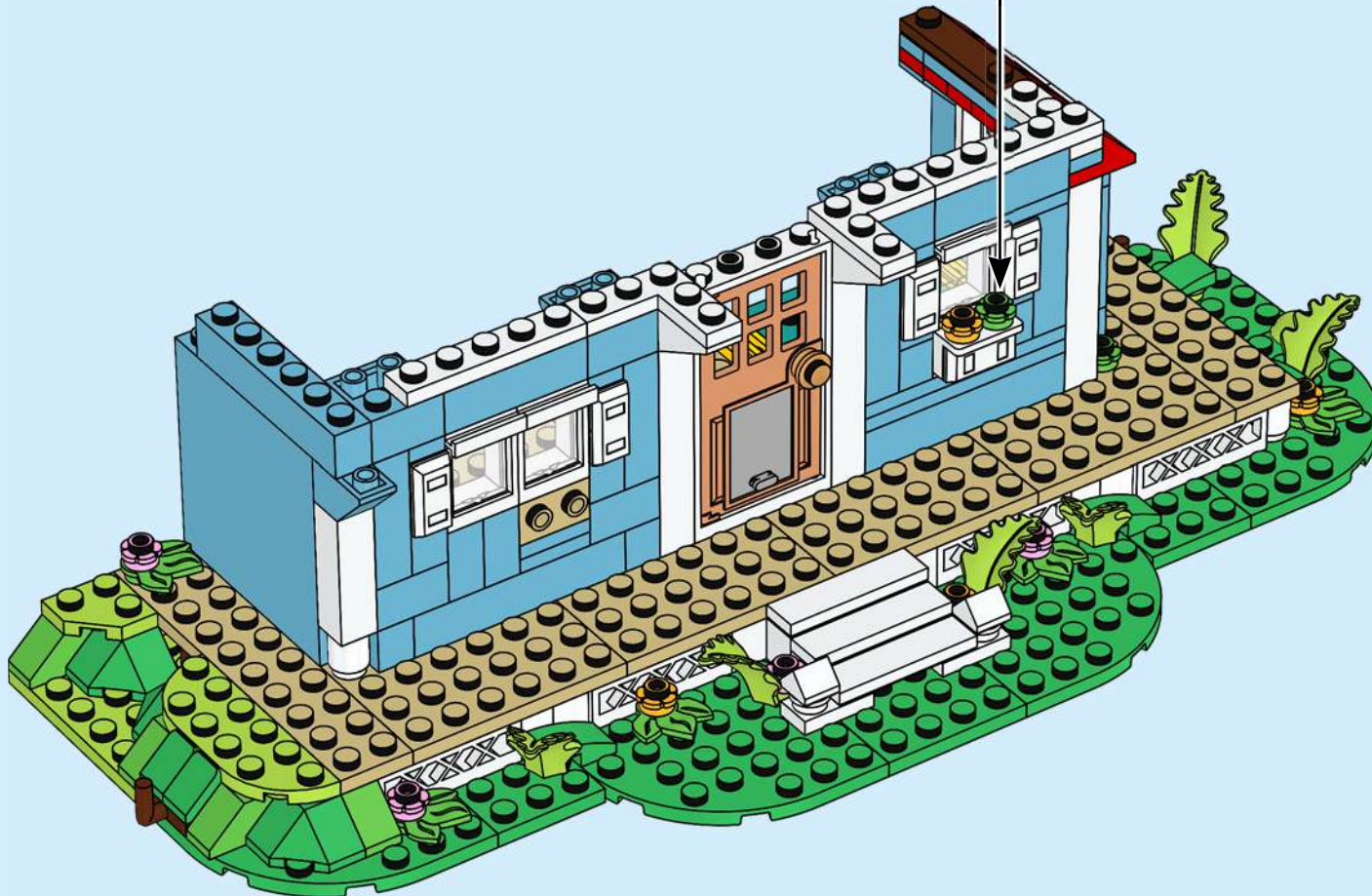
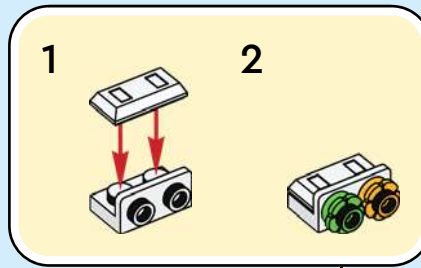

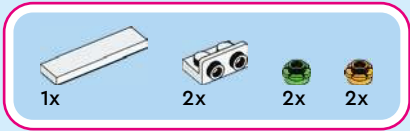

78

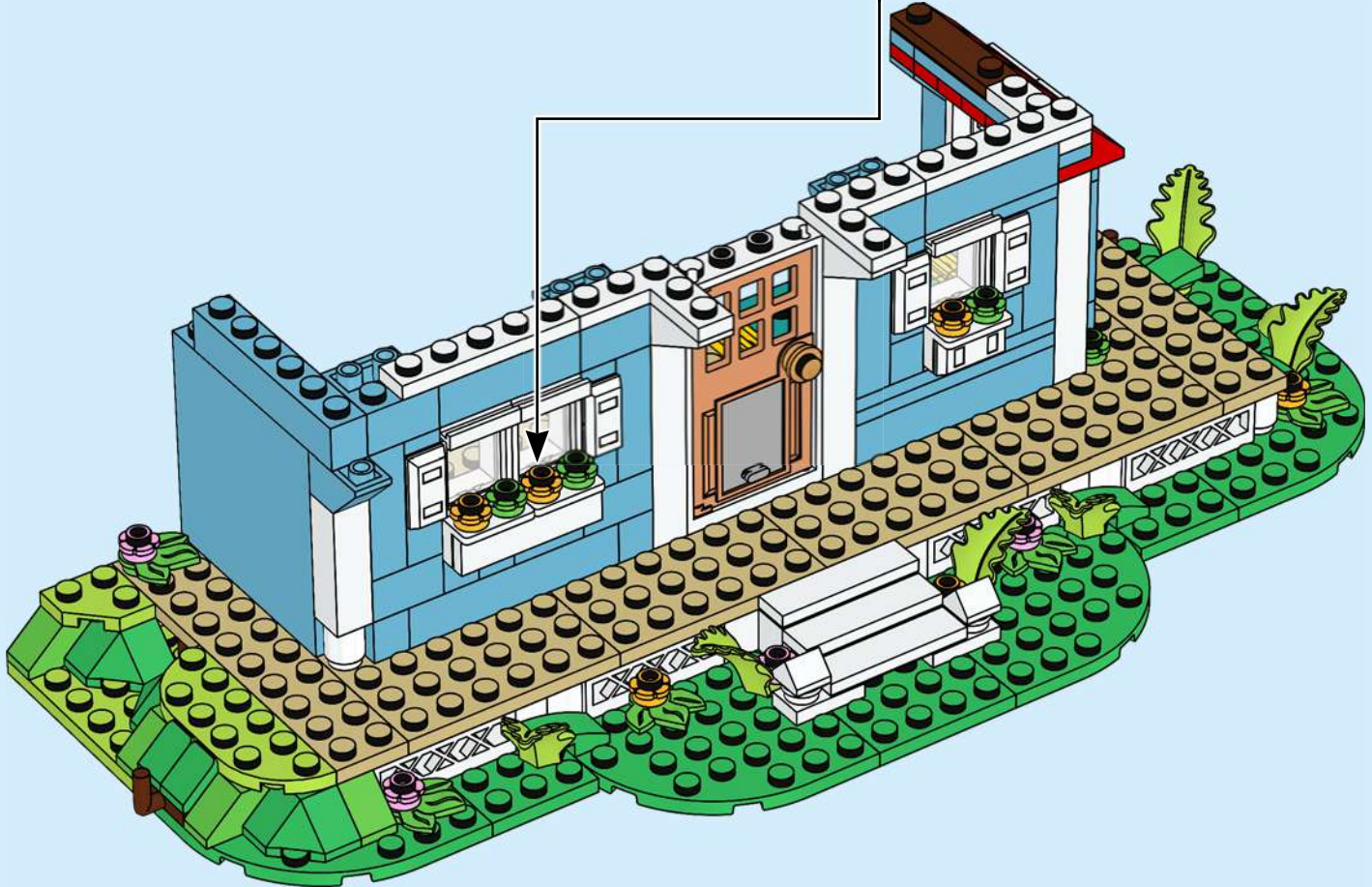
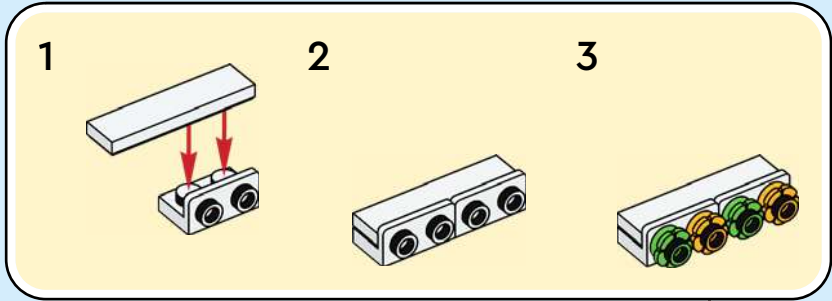



3x



2x

79

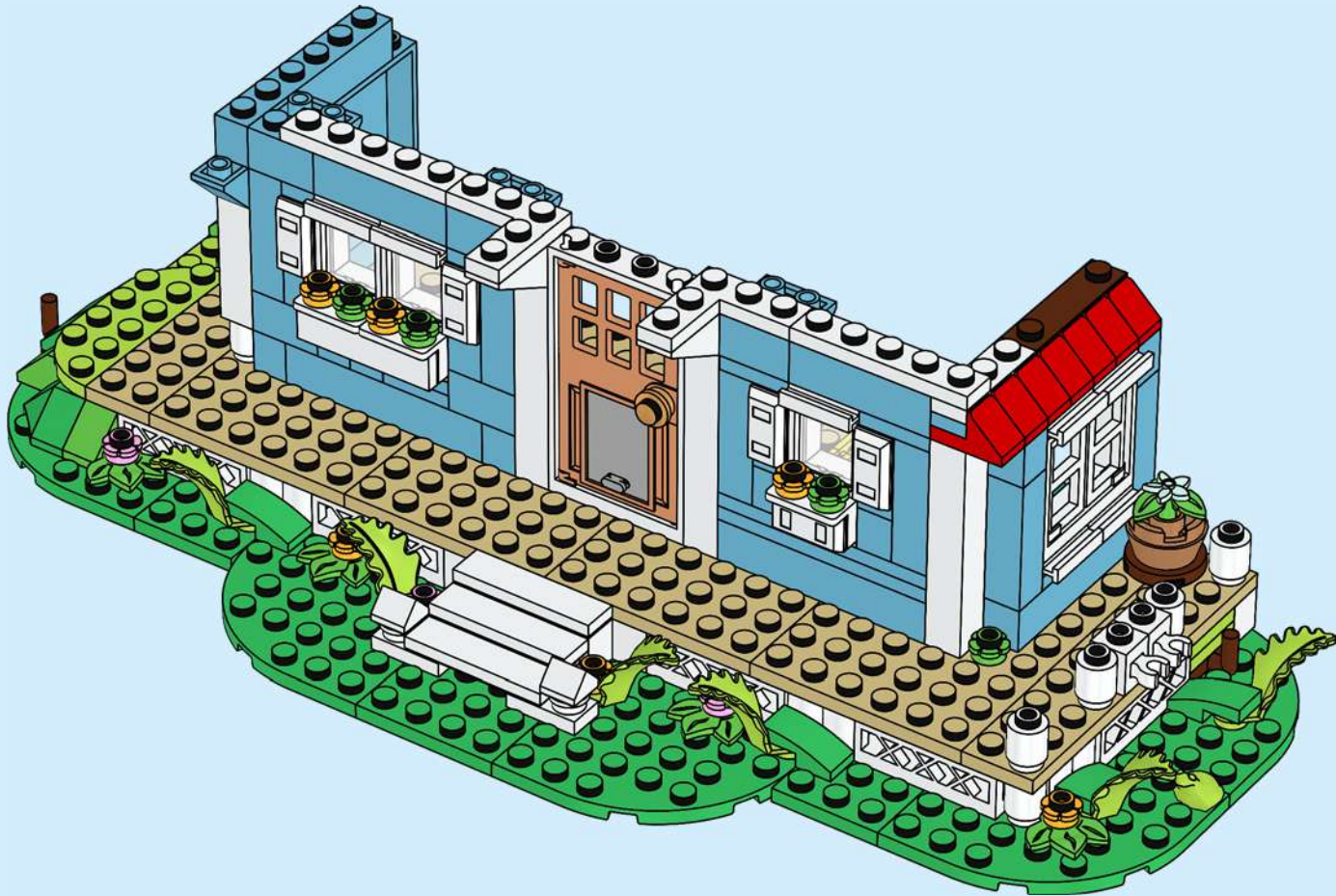



10x

80

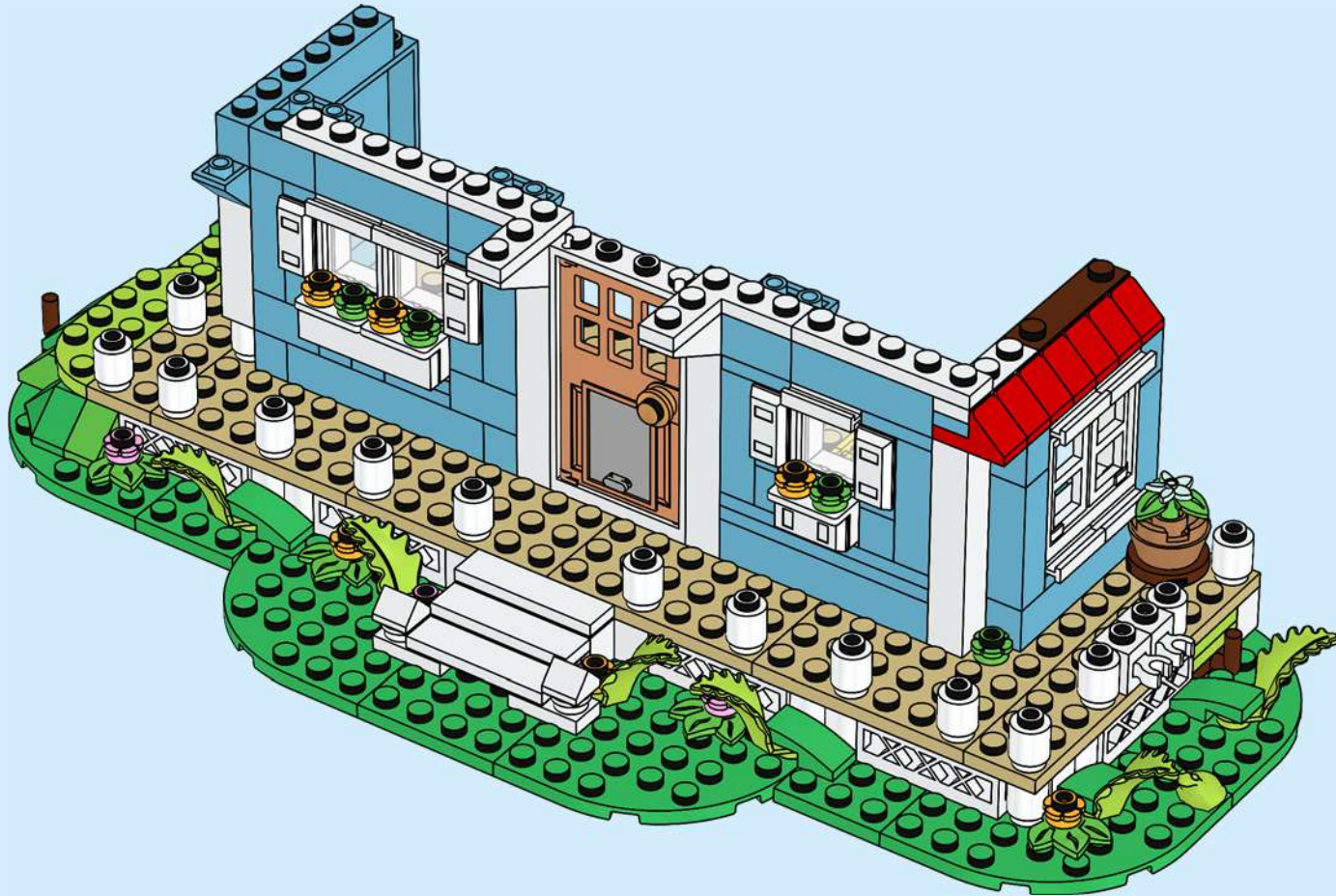

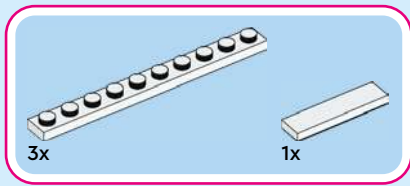

81

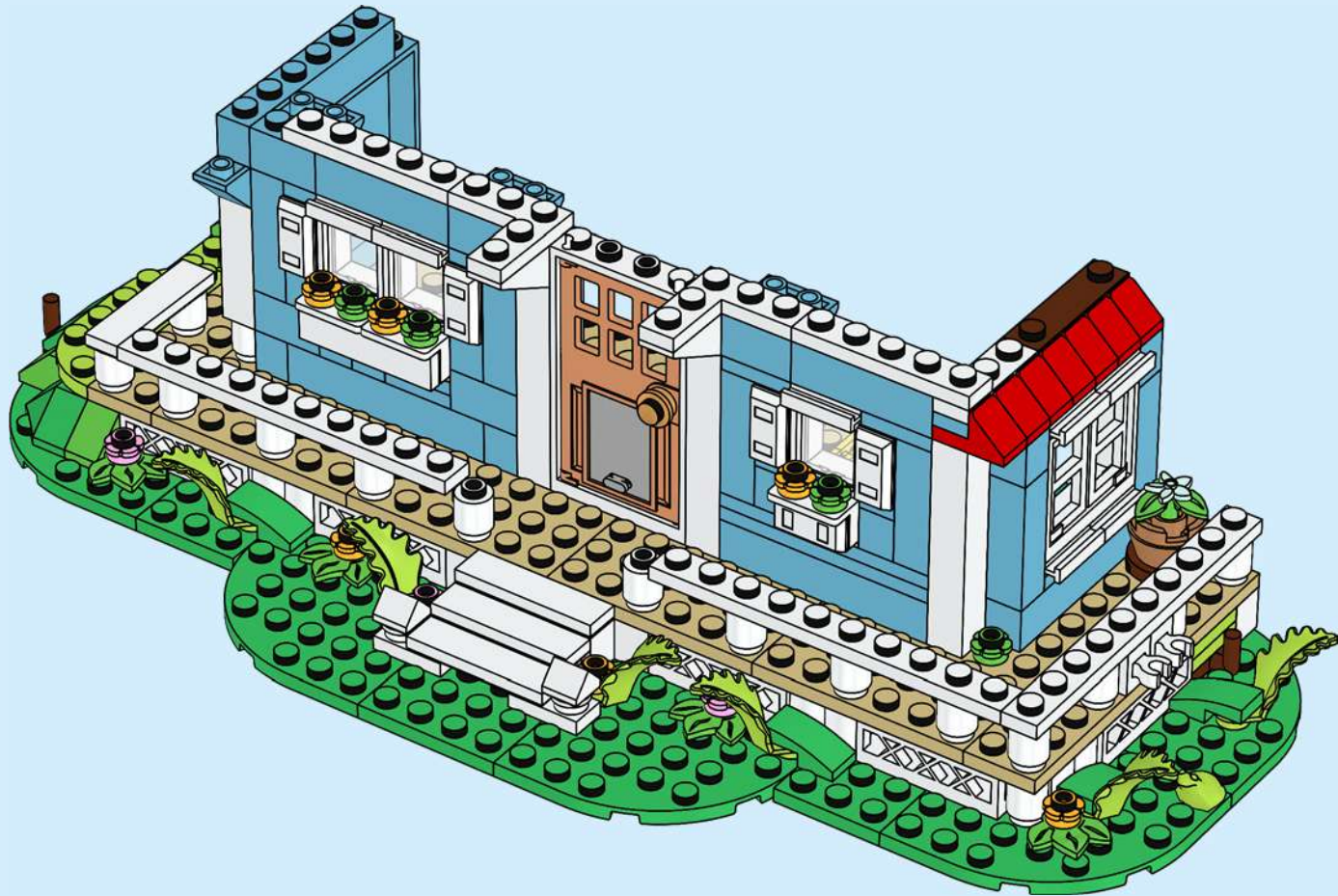

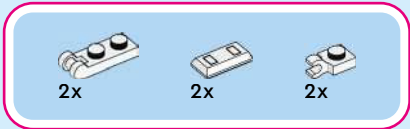

82

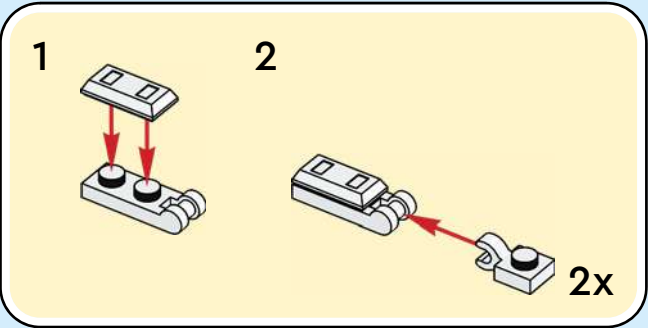

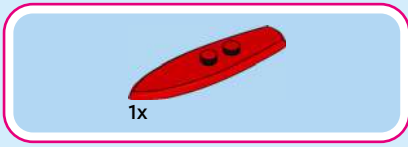

83

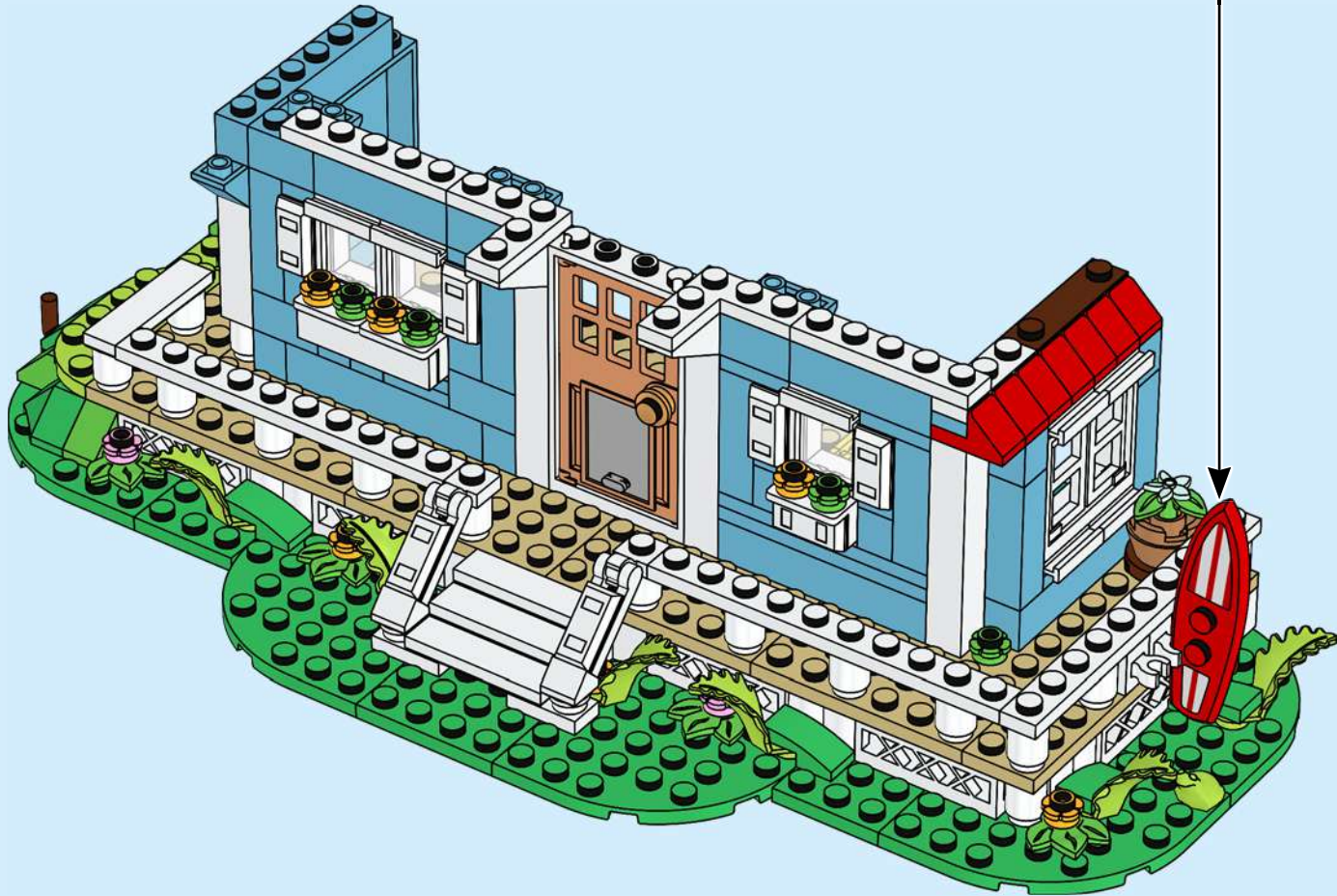
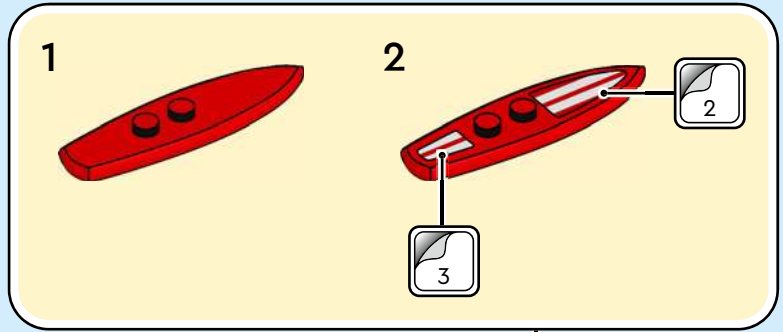

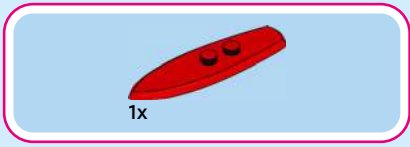

84

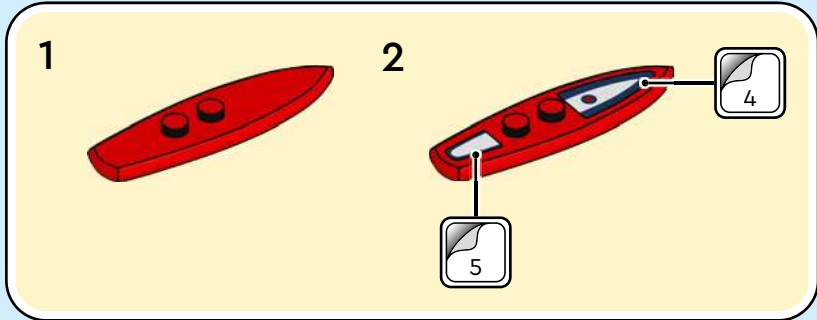

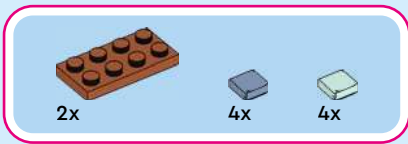

85

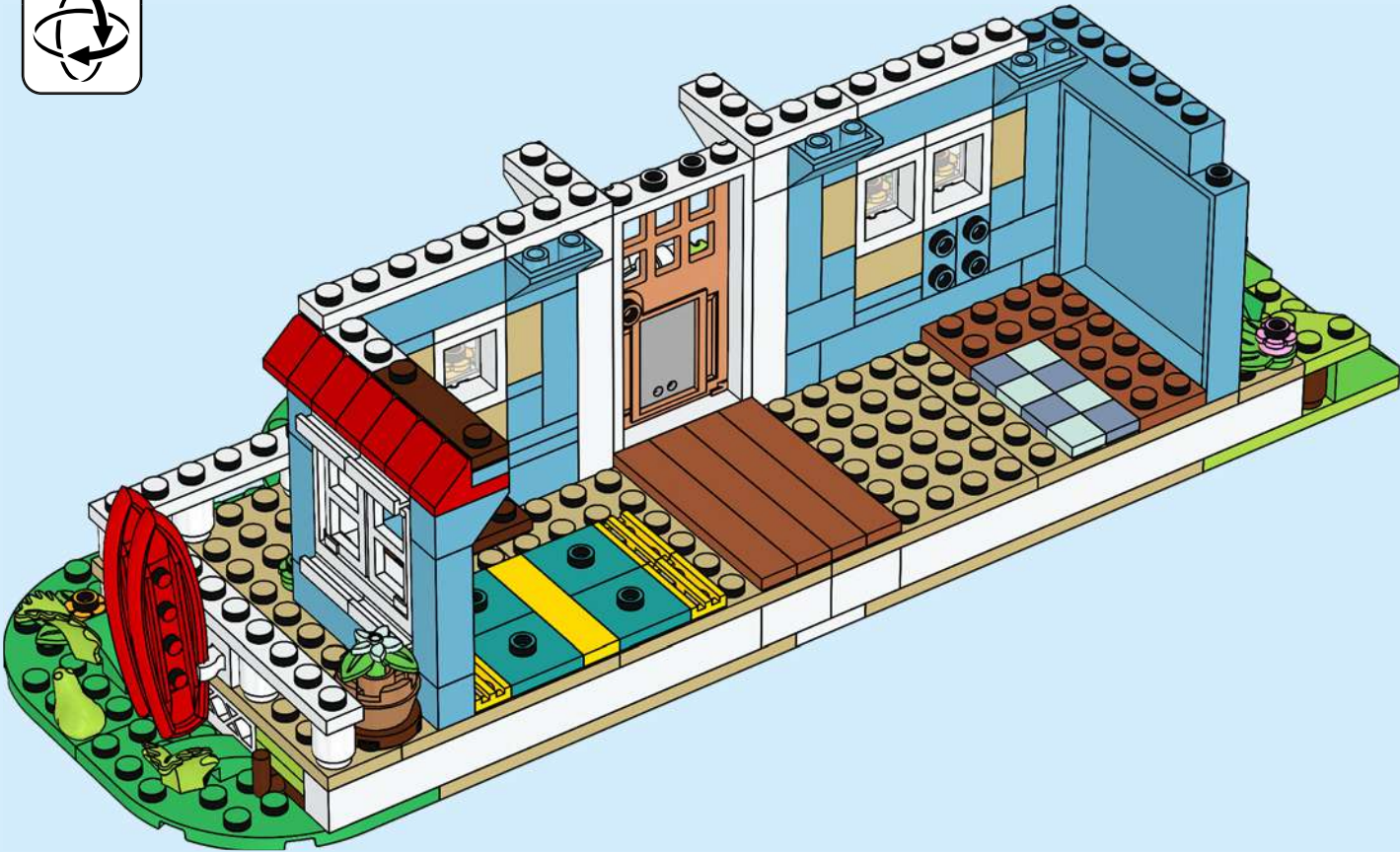

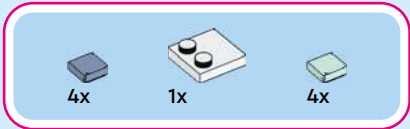

86

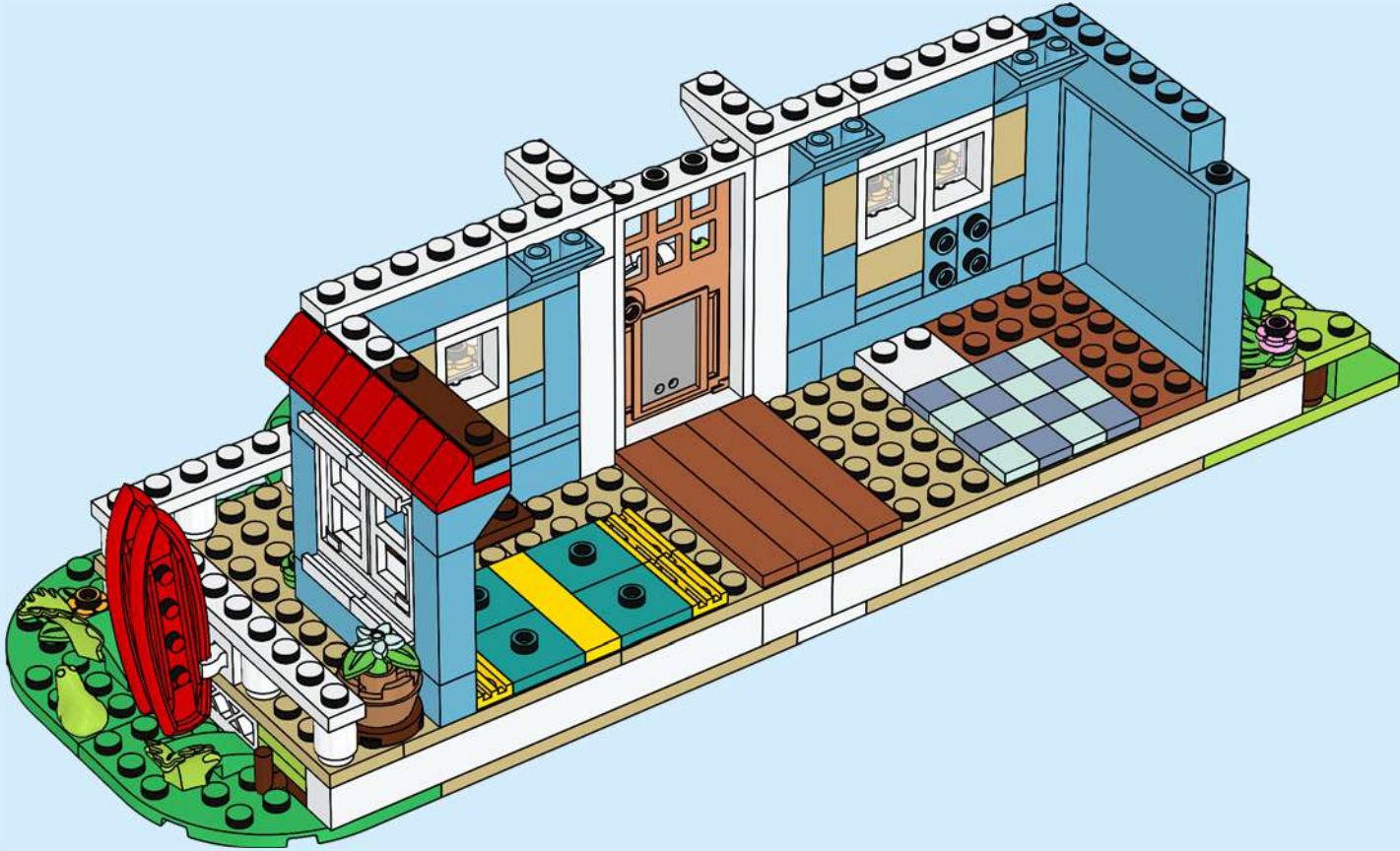



5x



6x

87

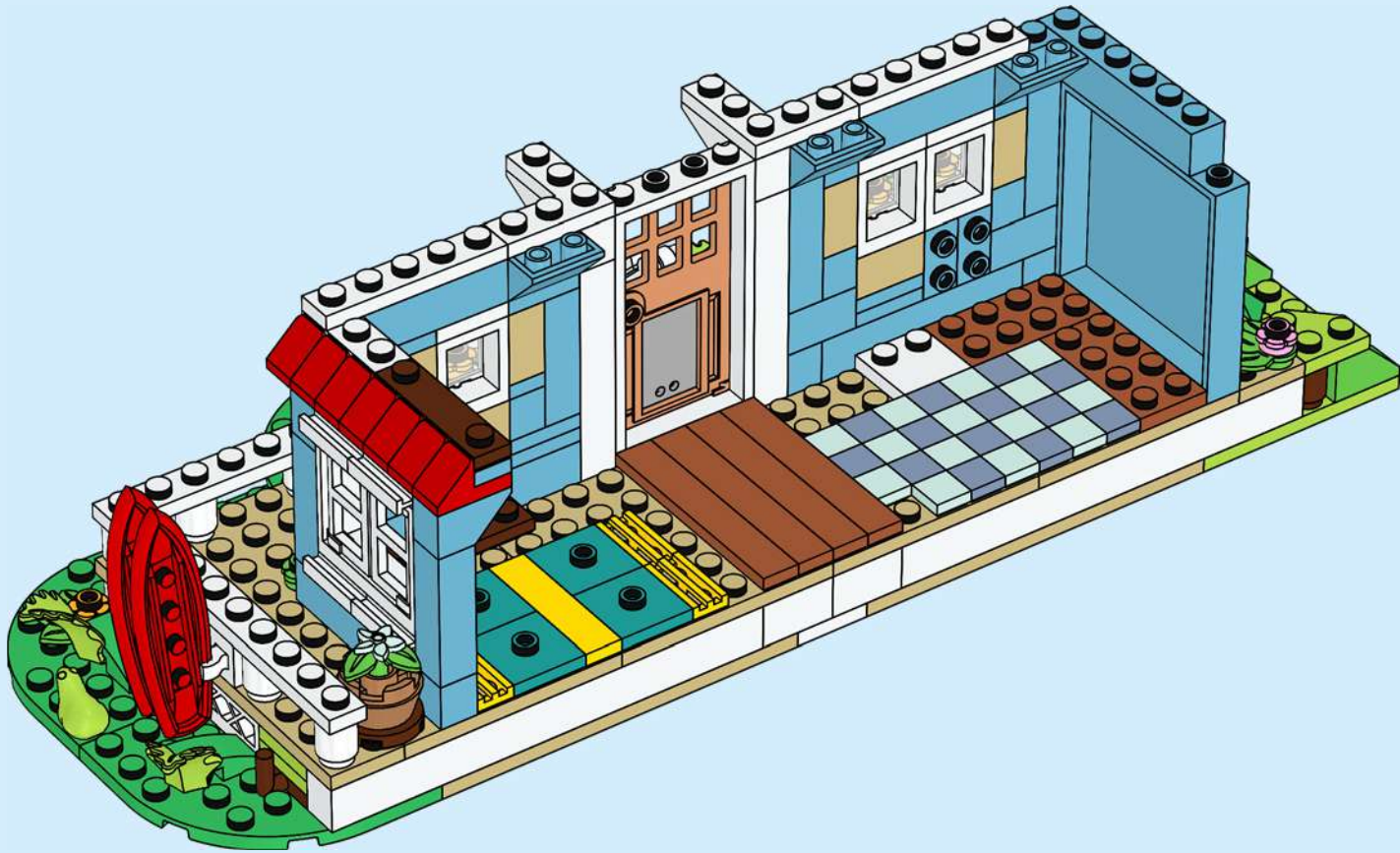



1

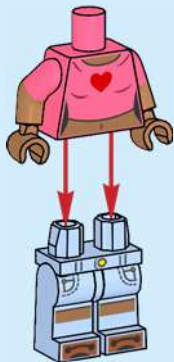

2

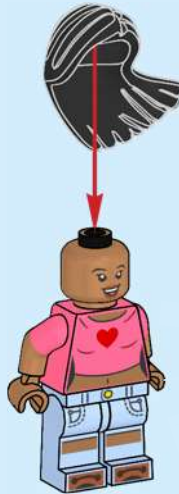

3



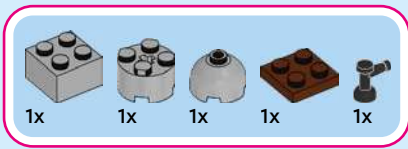

88

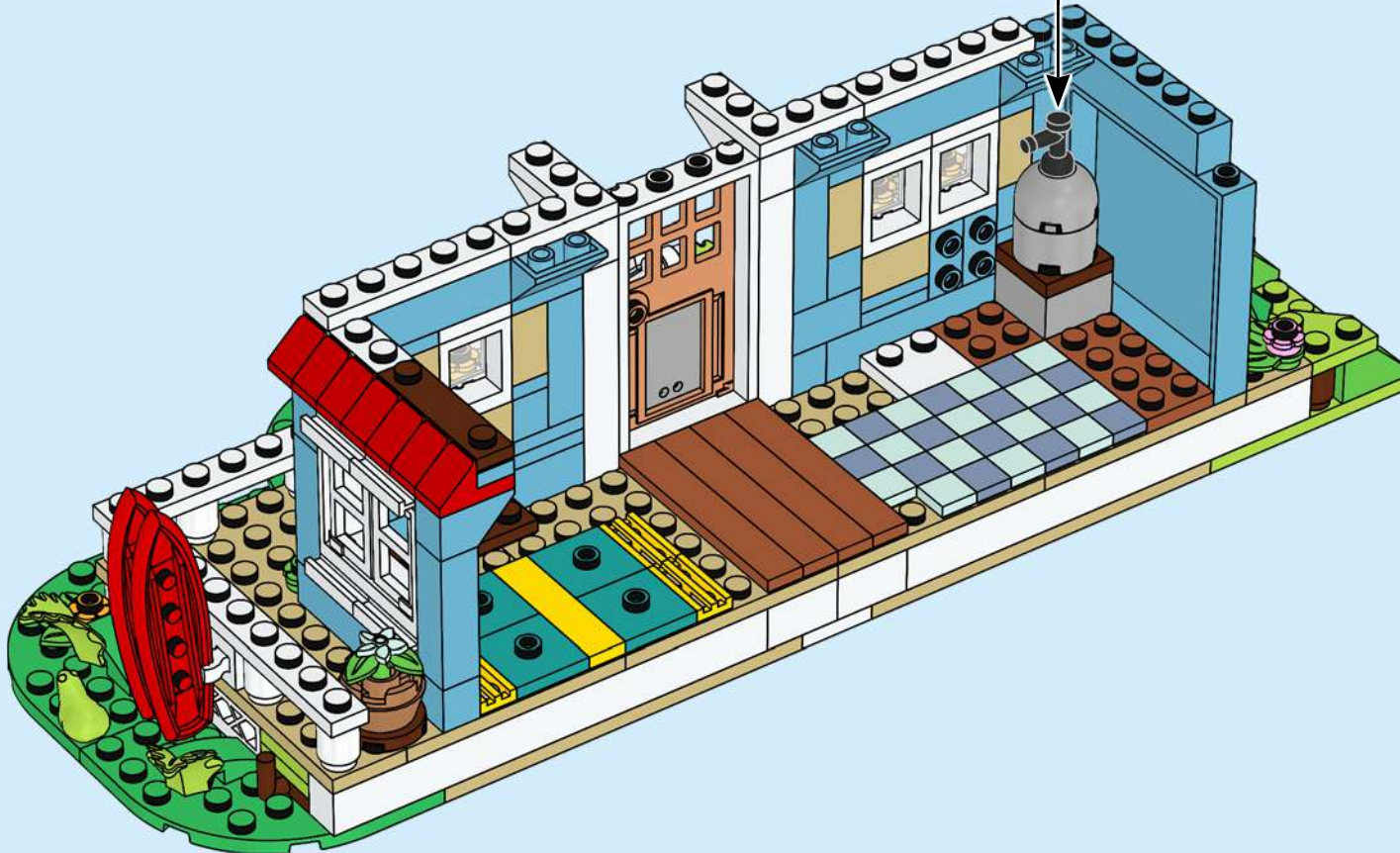
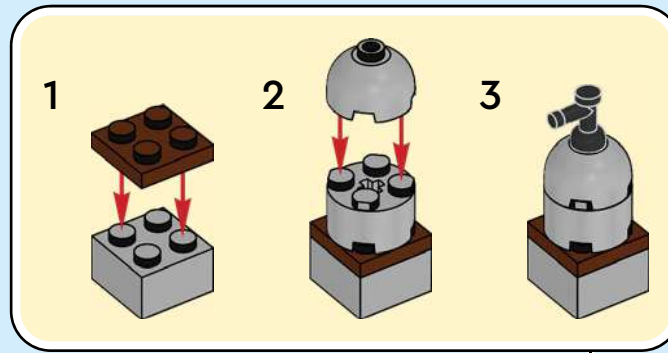

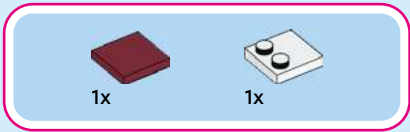

89

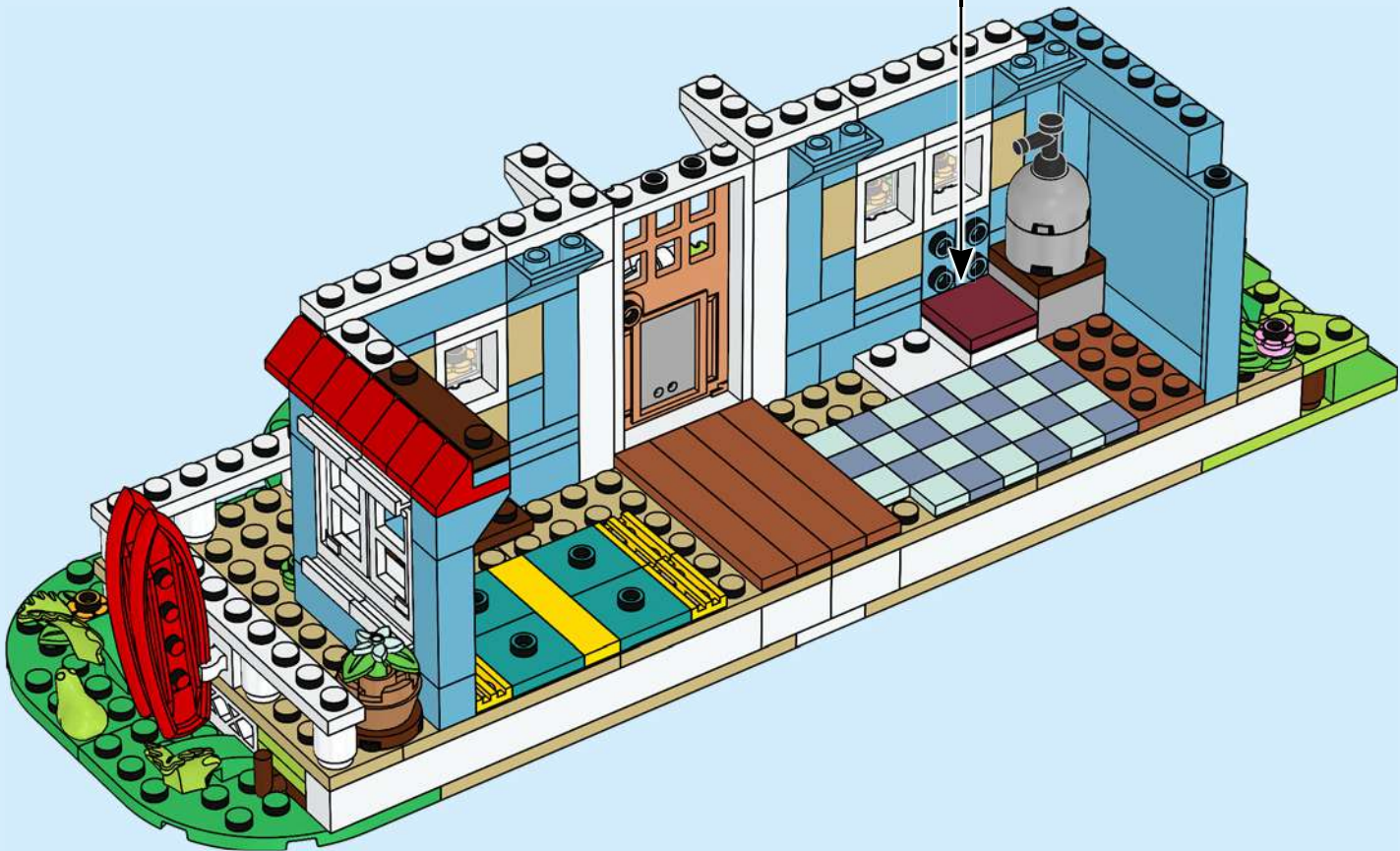
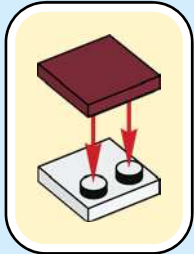

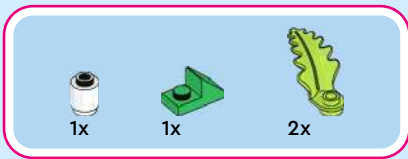

90

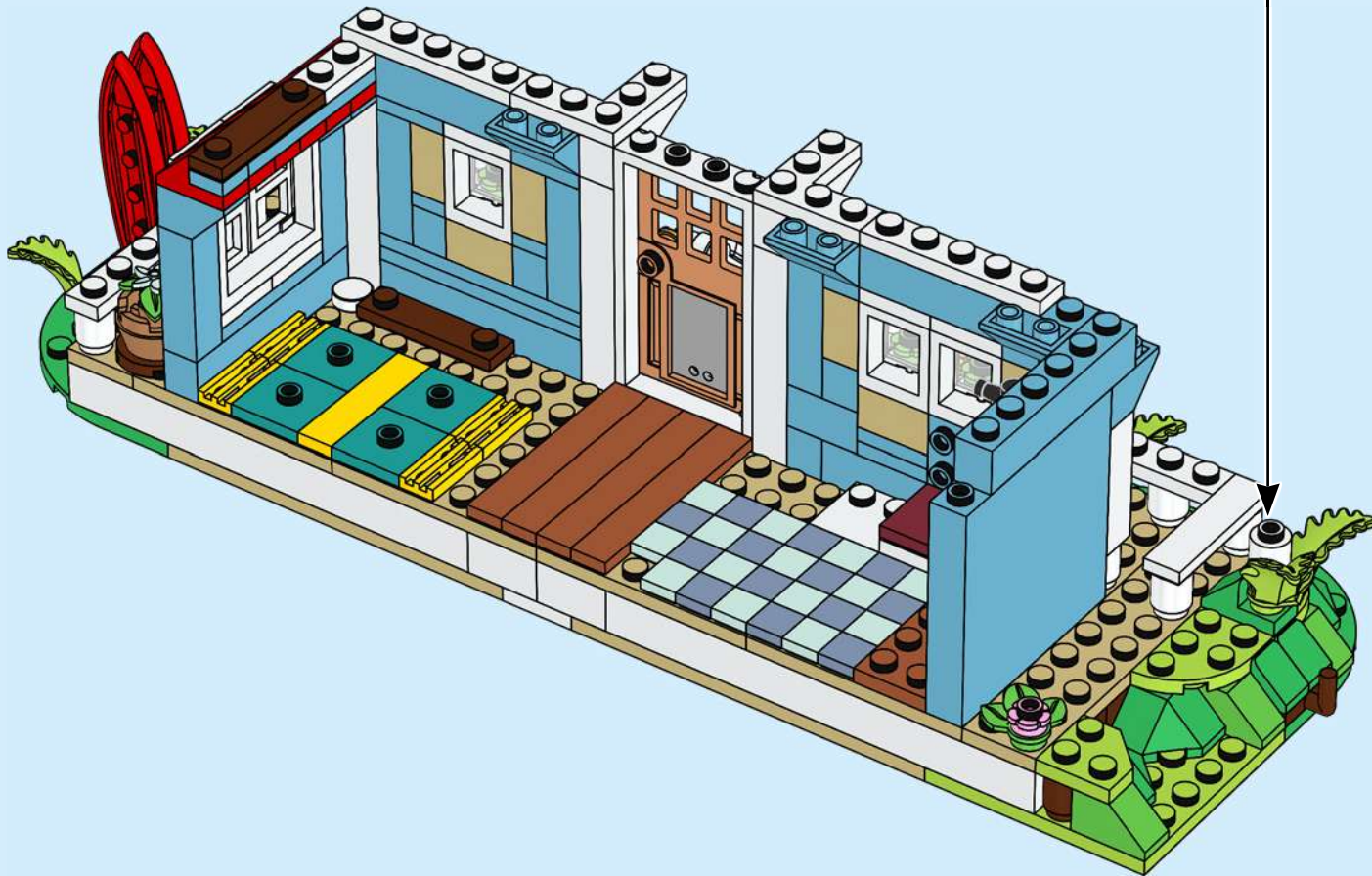
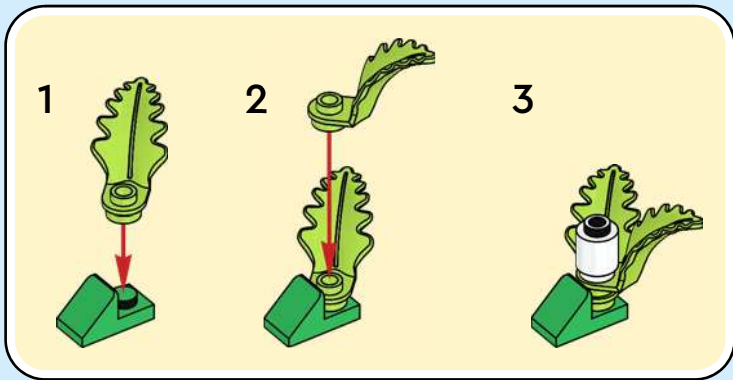



1x

91

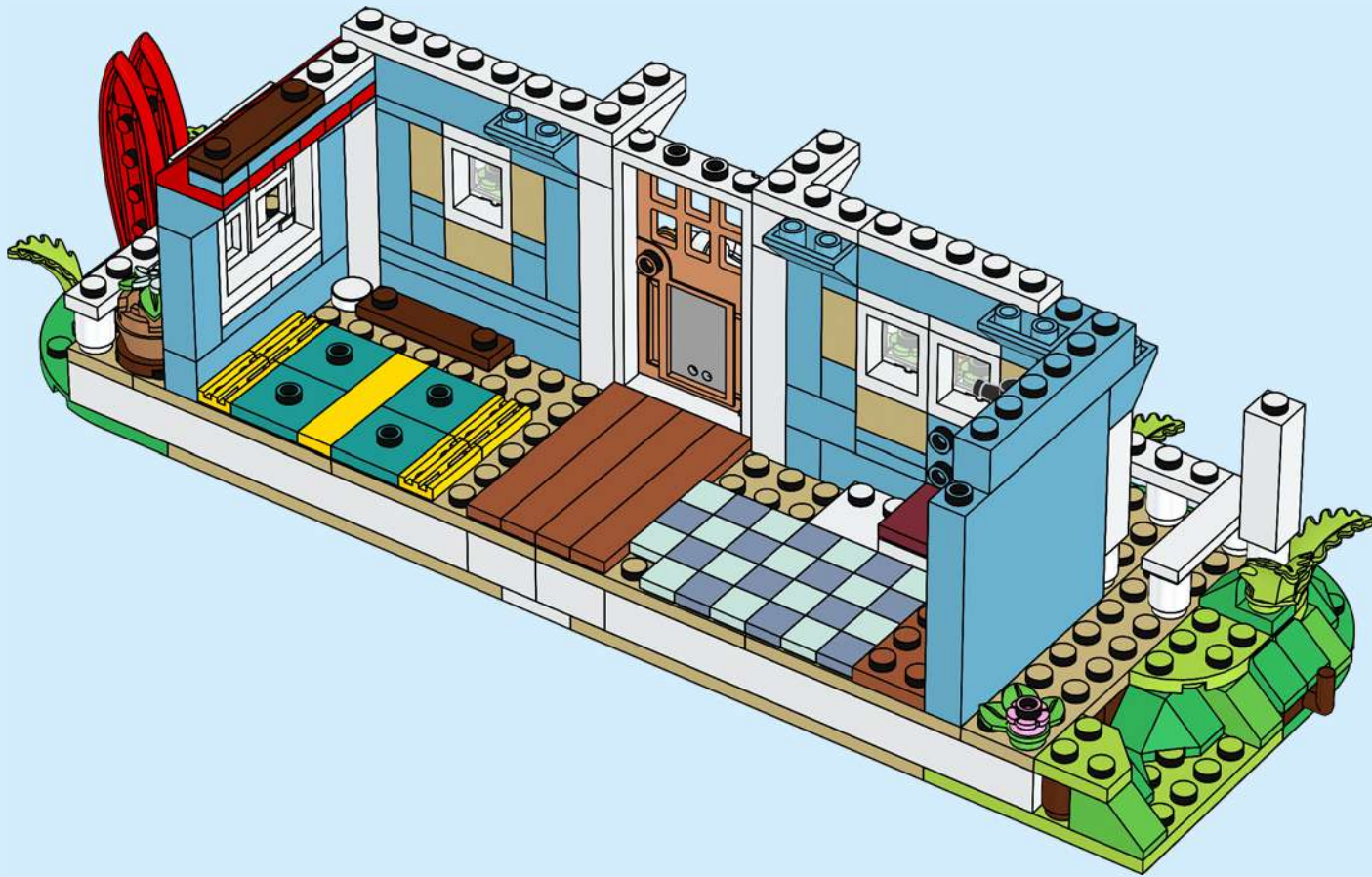

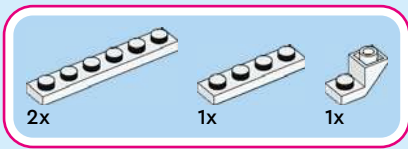

92

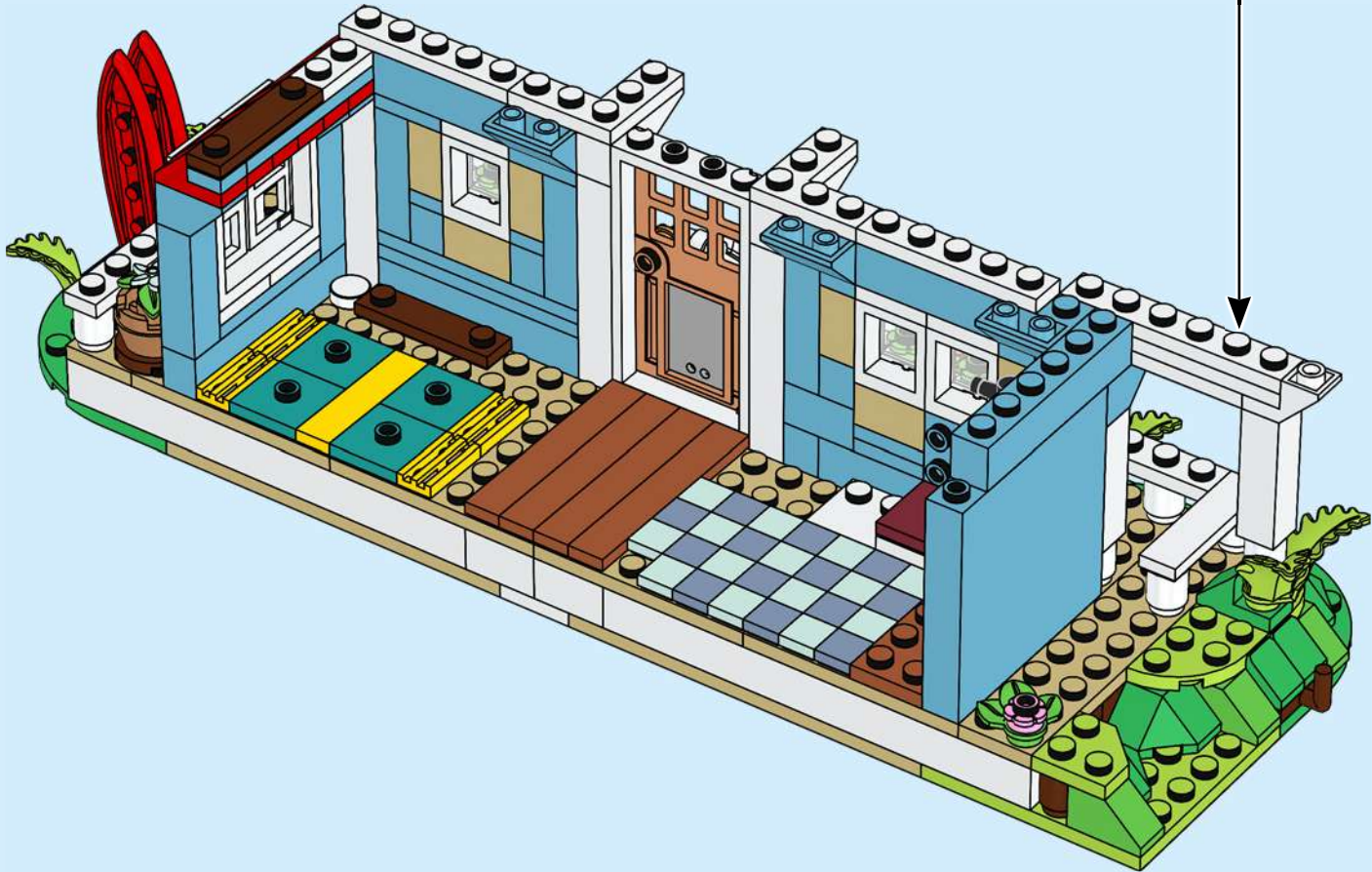
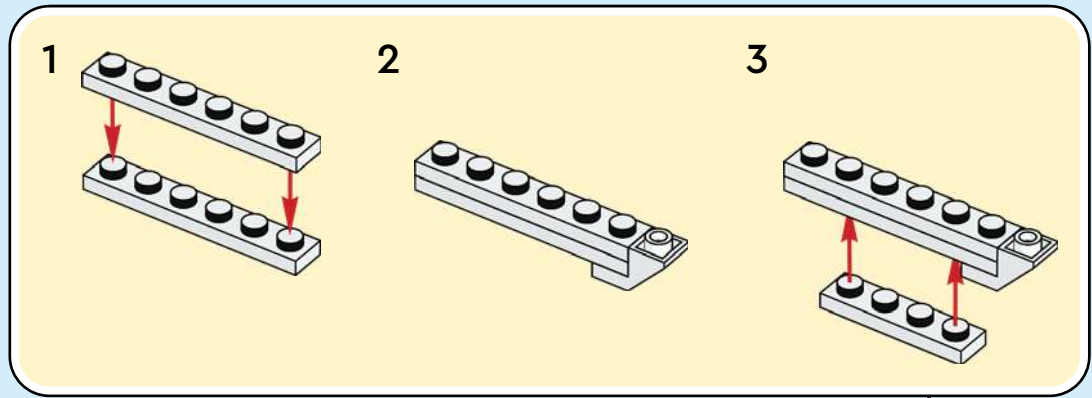

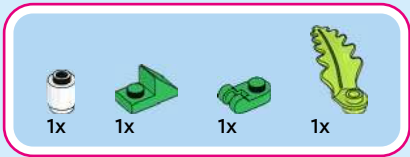

93

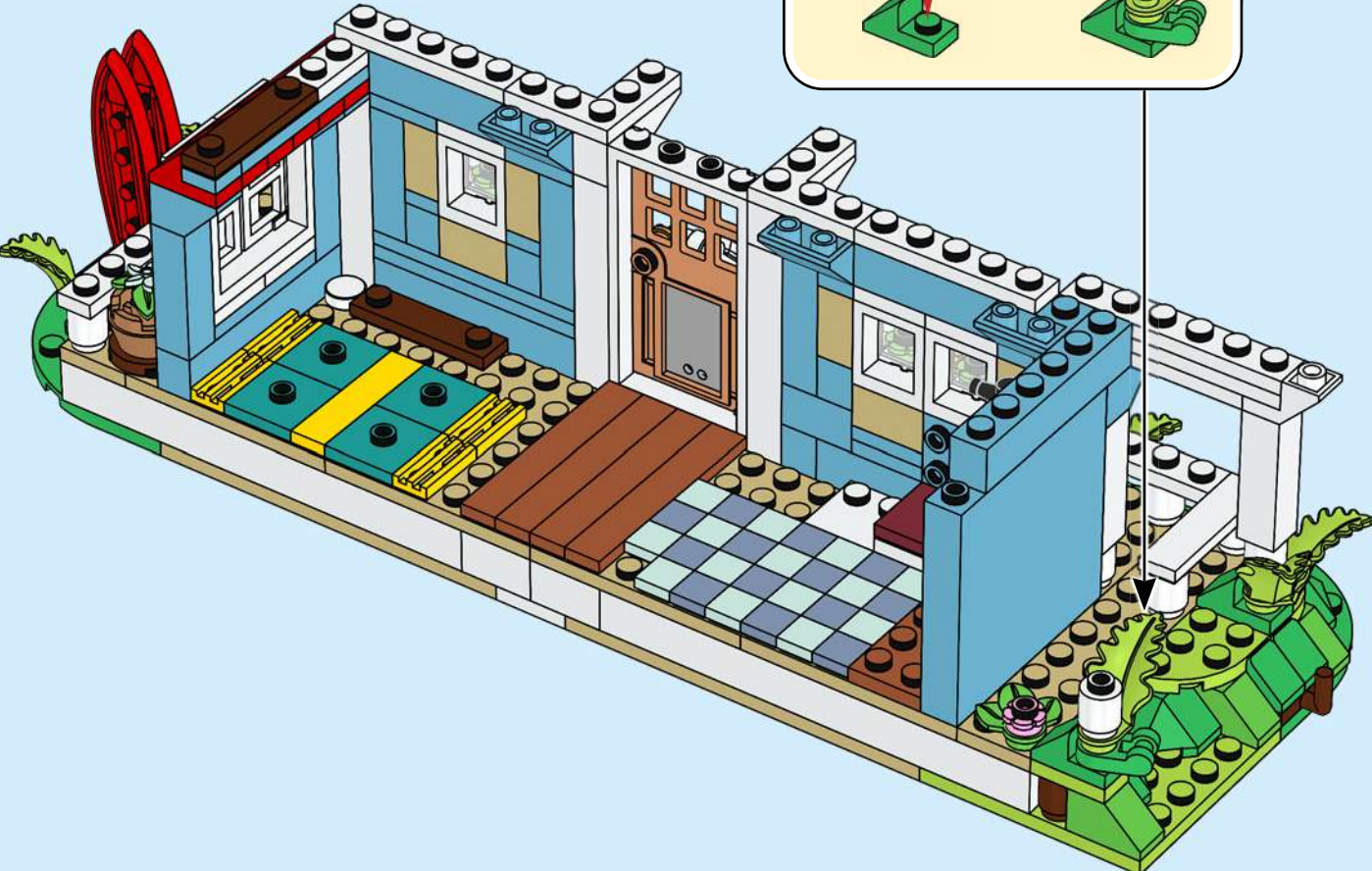
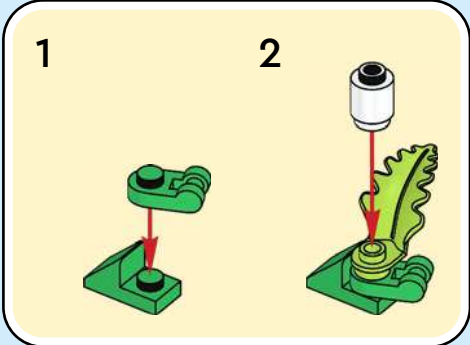

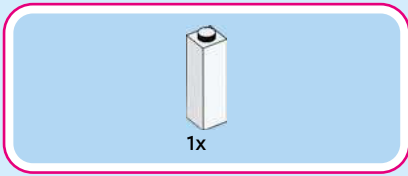

94

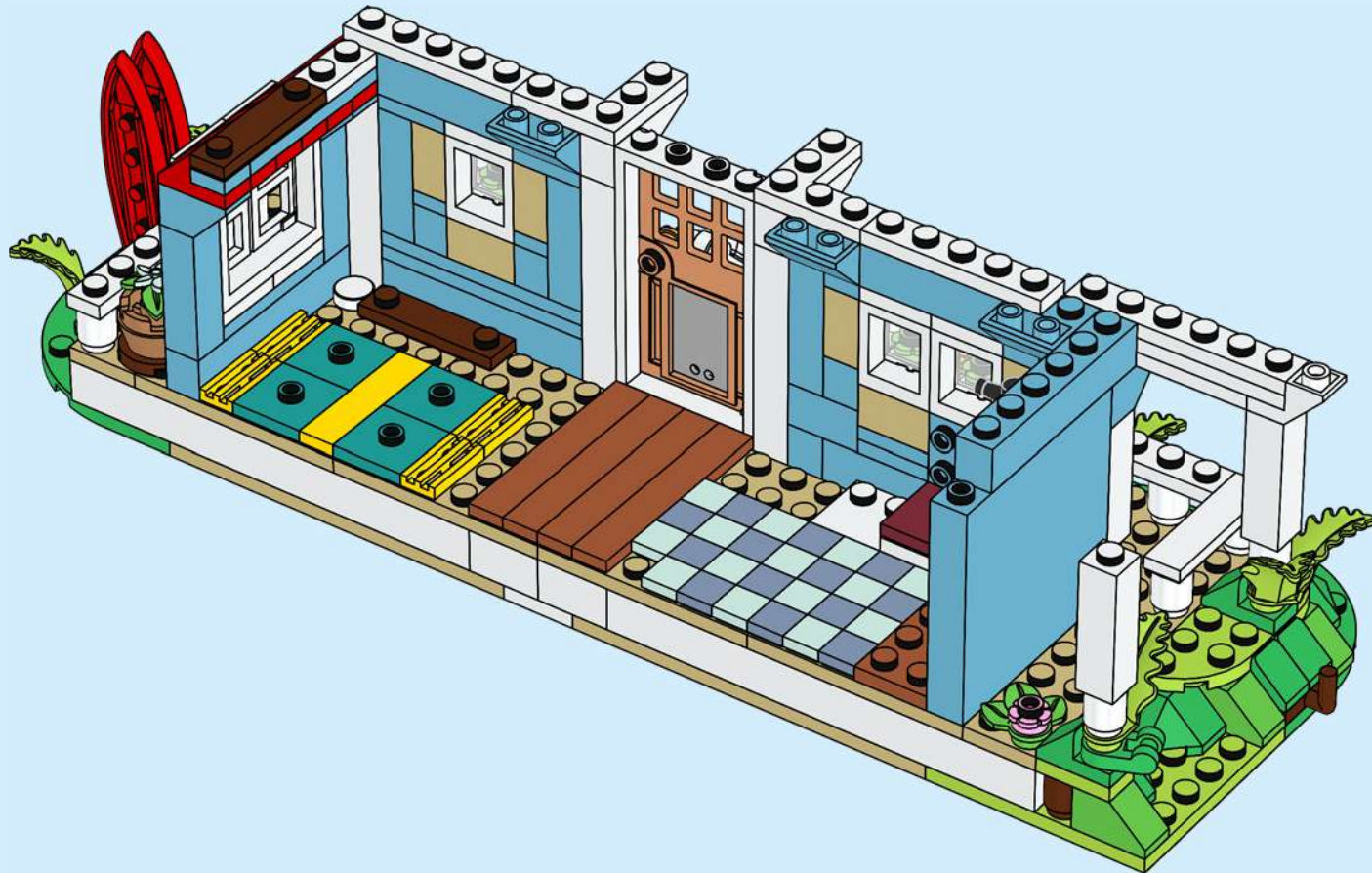

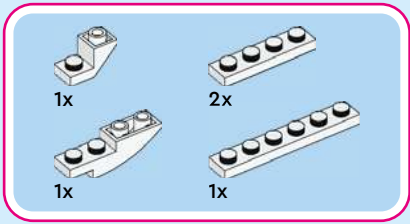

95

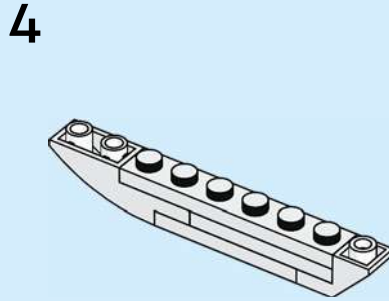
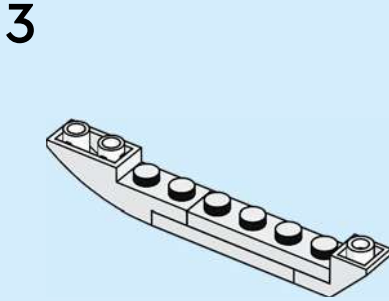
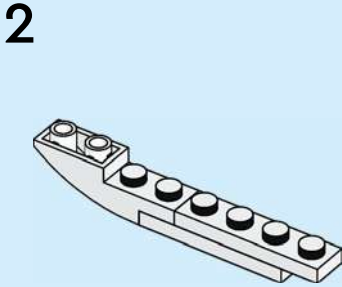
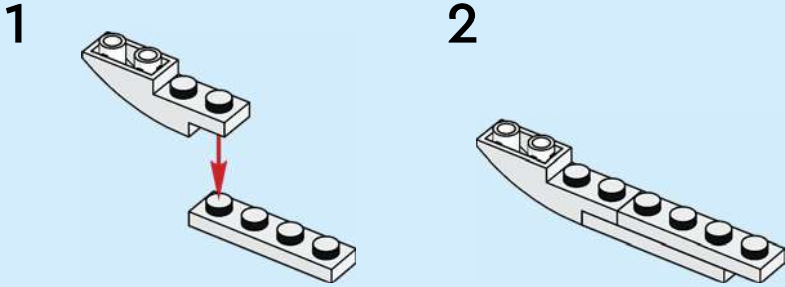

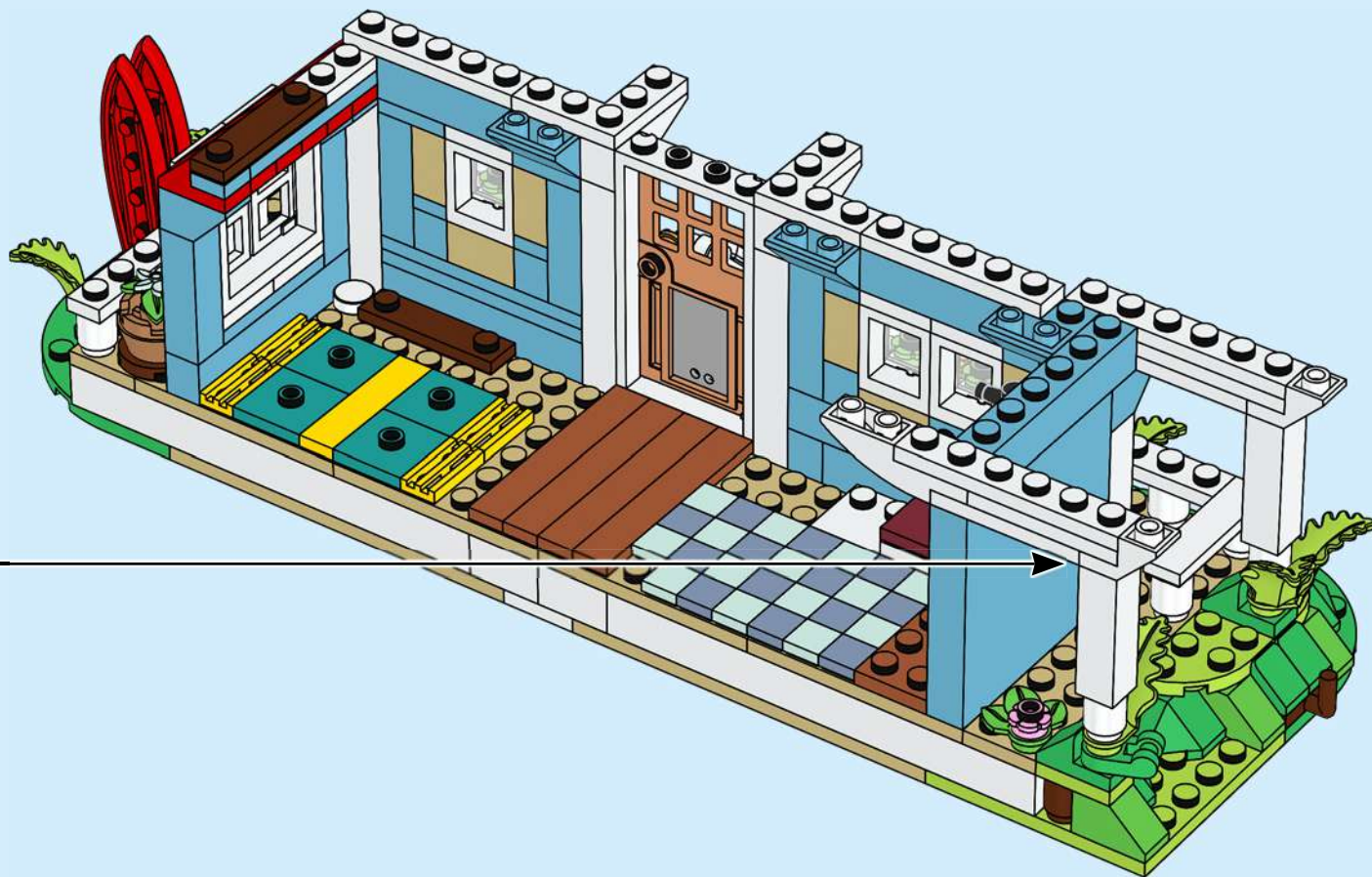



1x

96

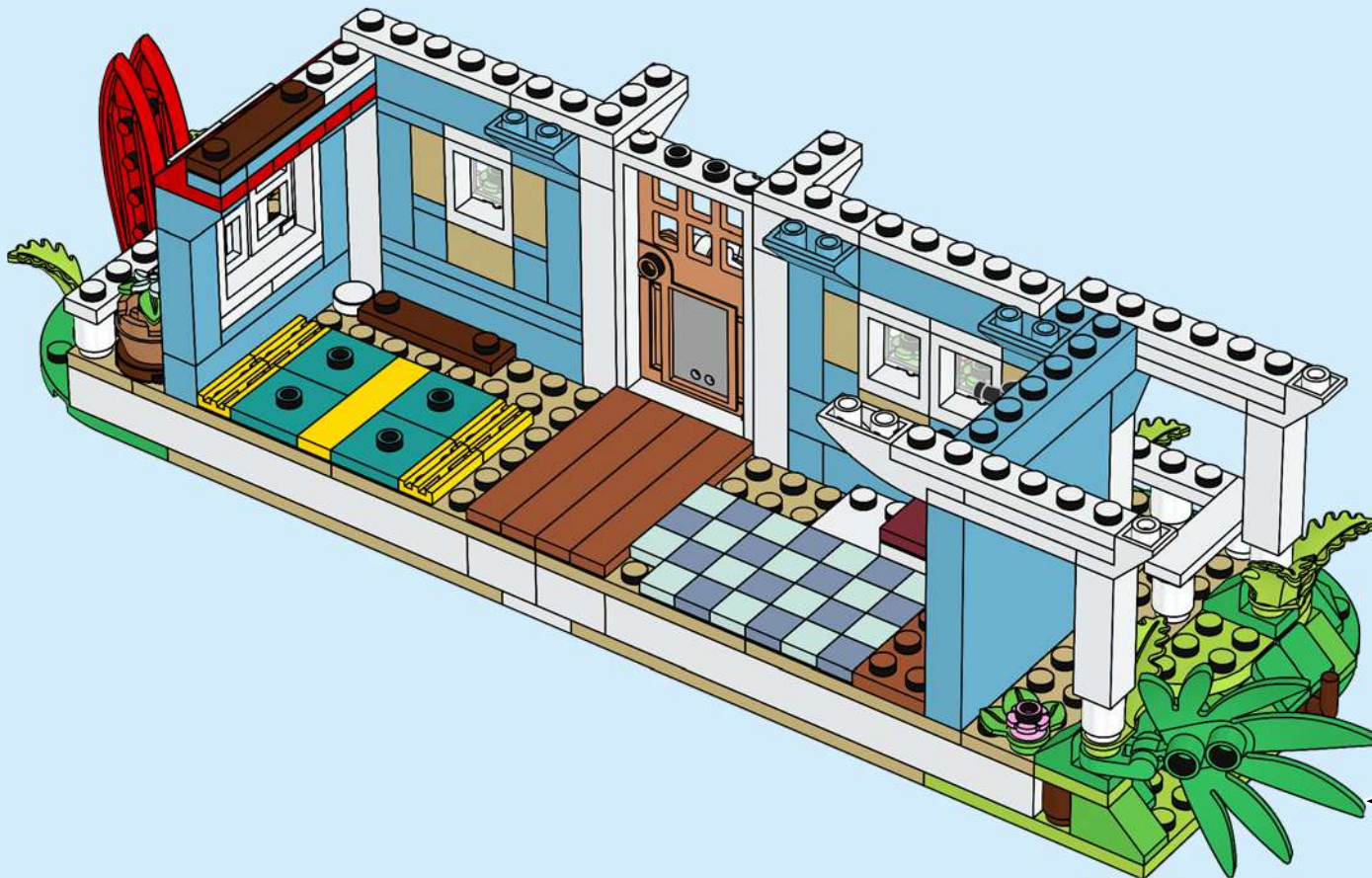

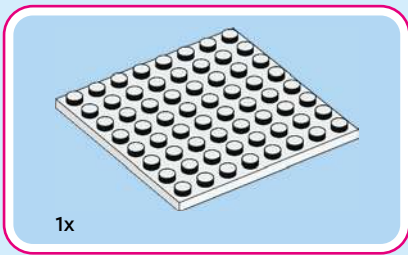

97

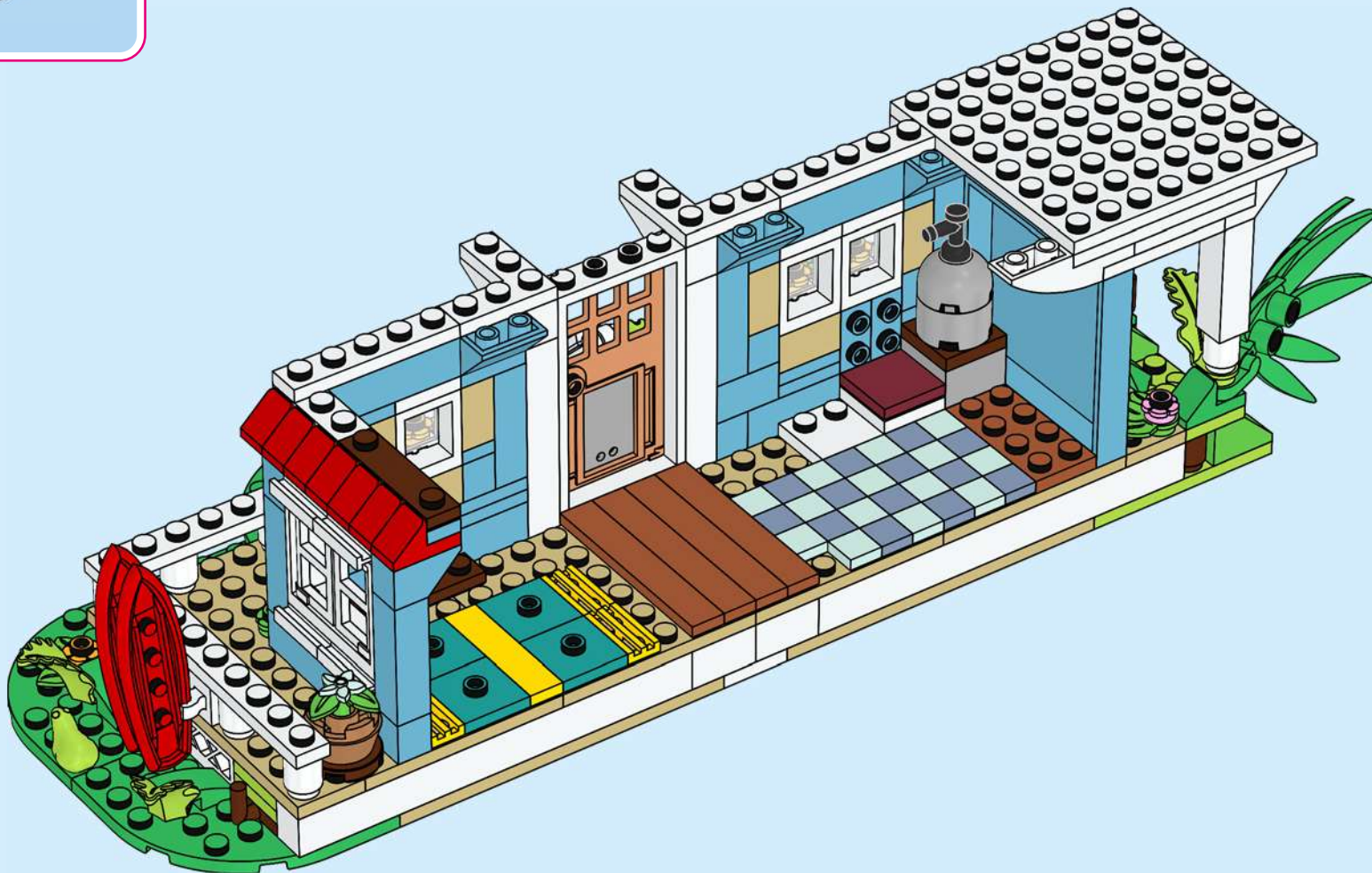



1x



1x

98

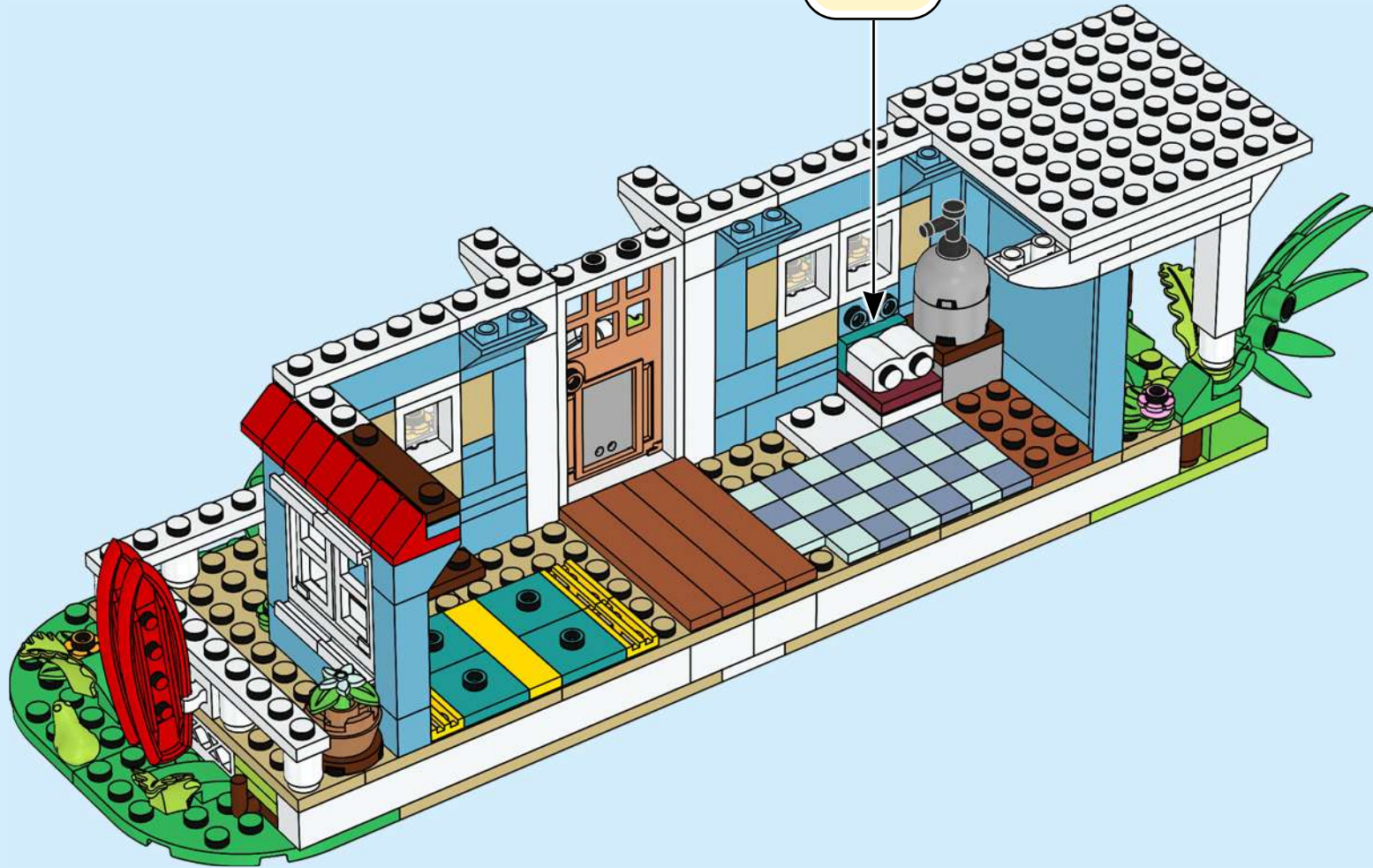
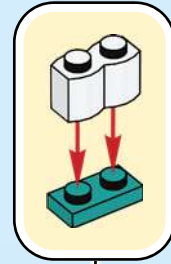

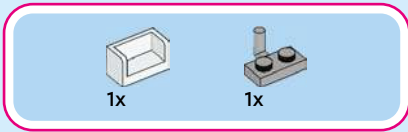

99

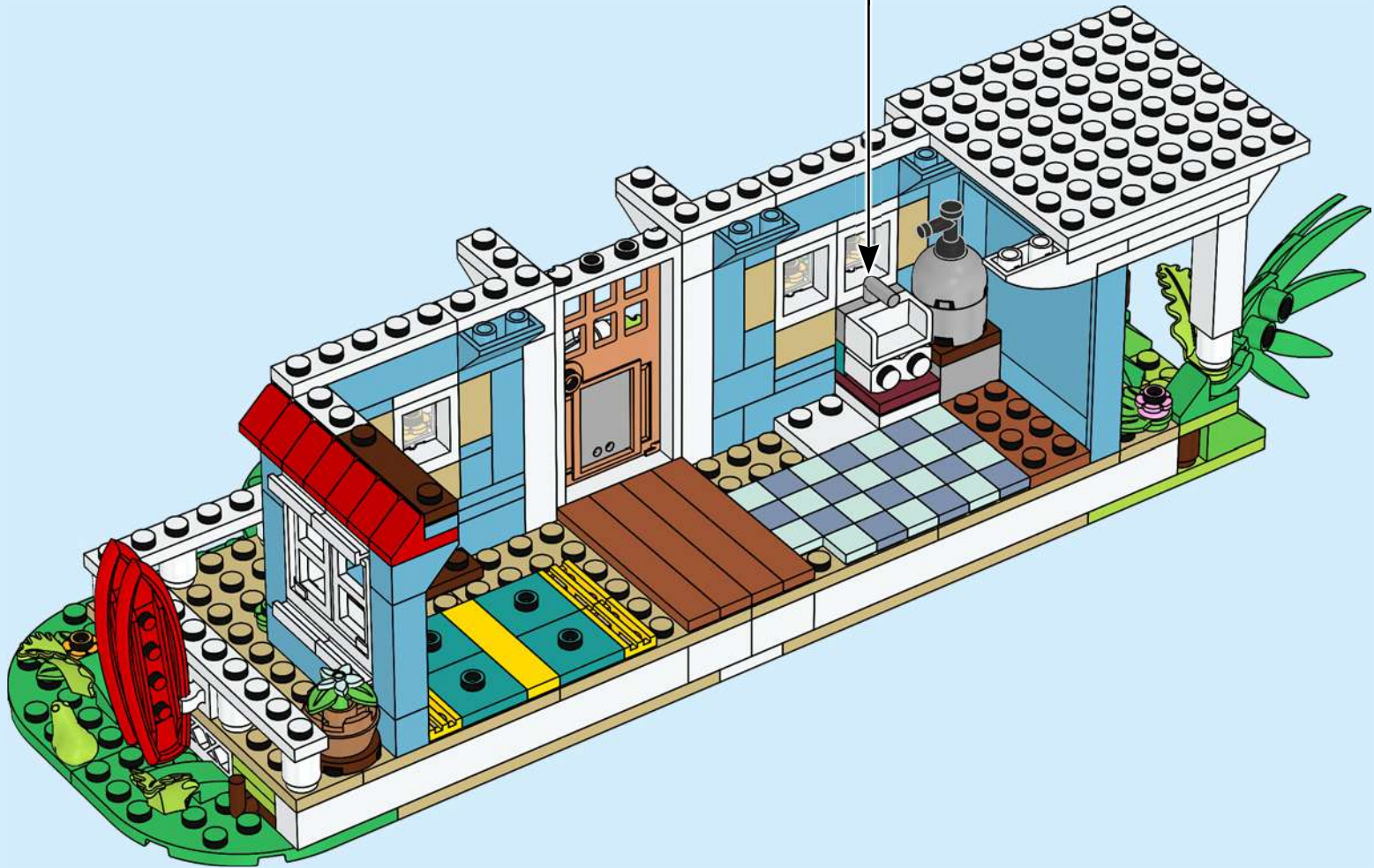
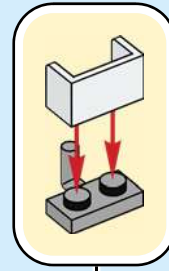



1x

100

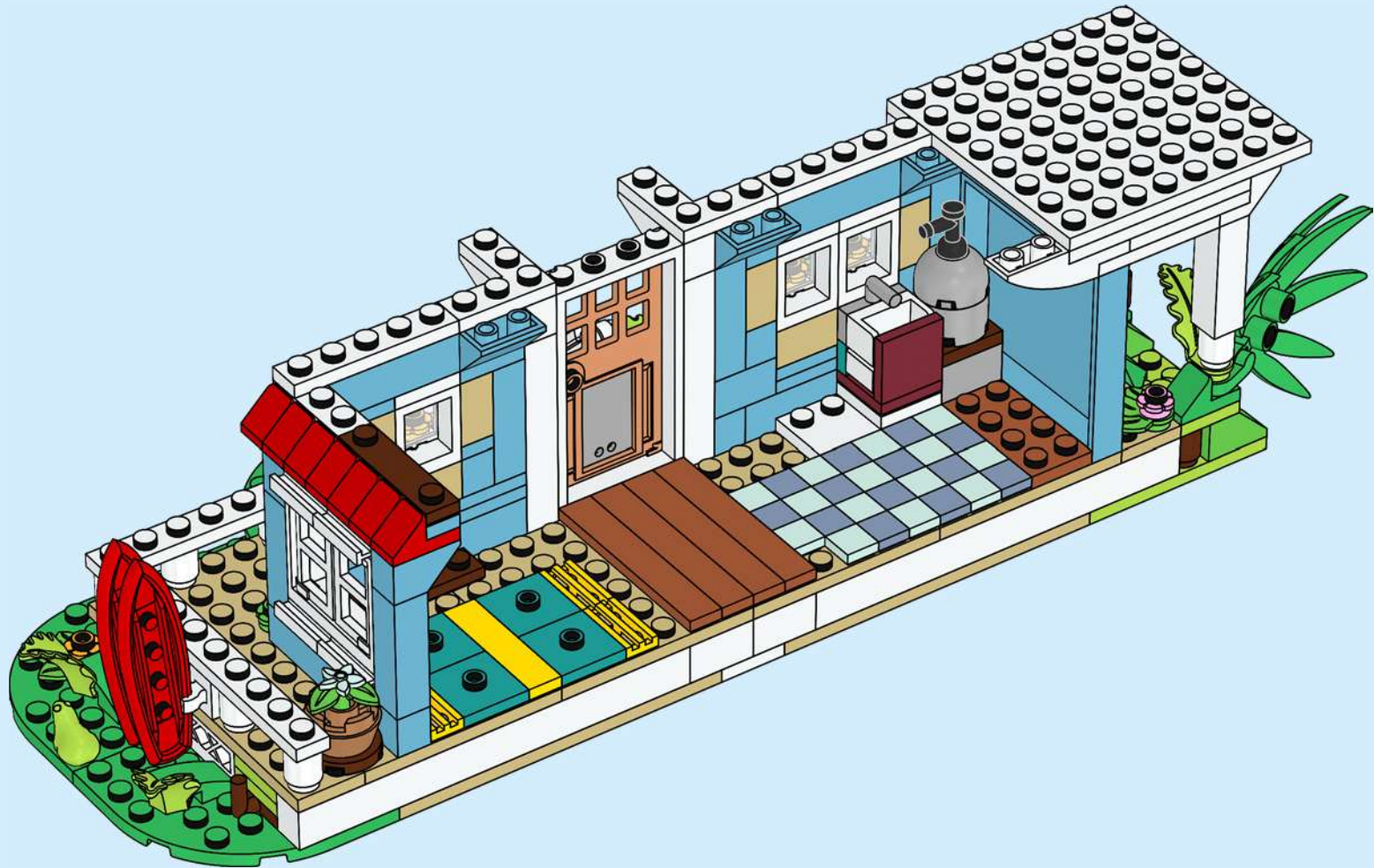

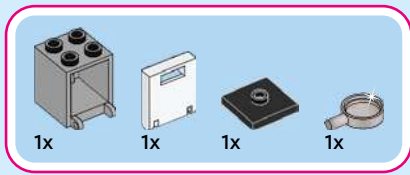

101

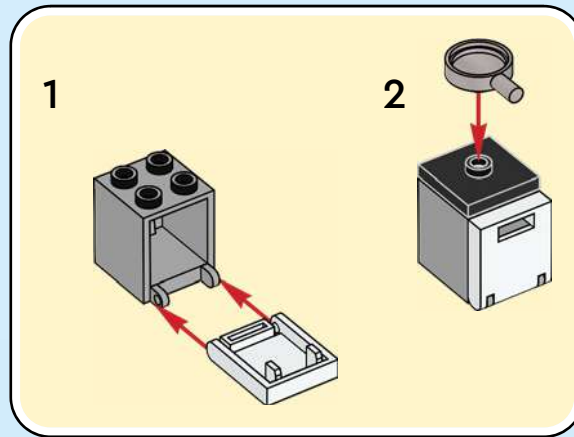

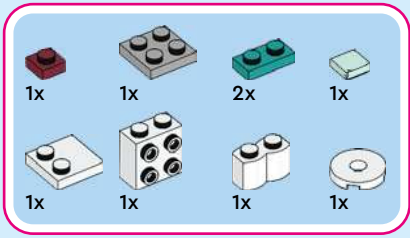

102

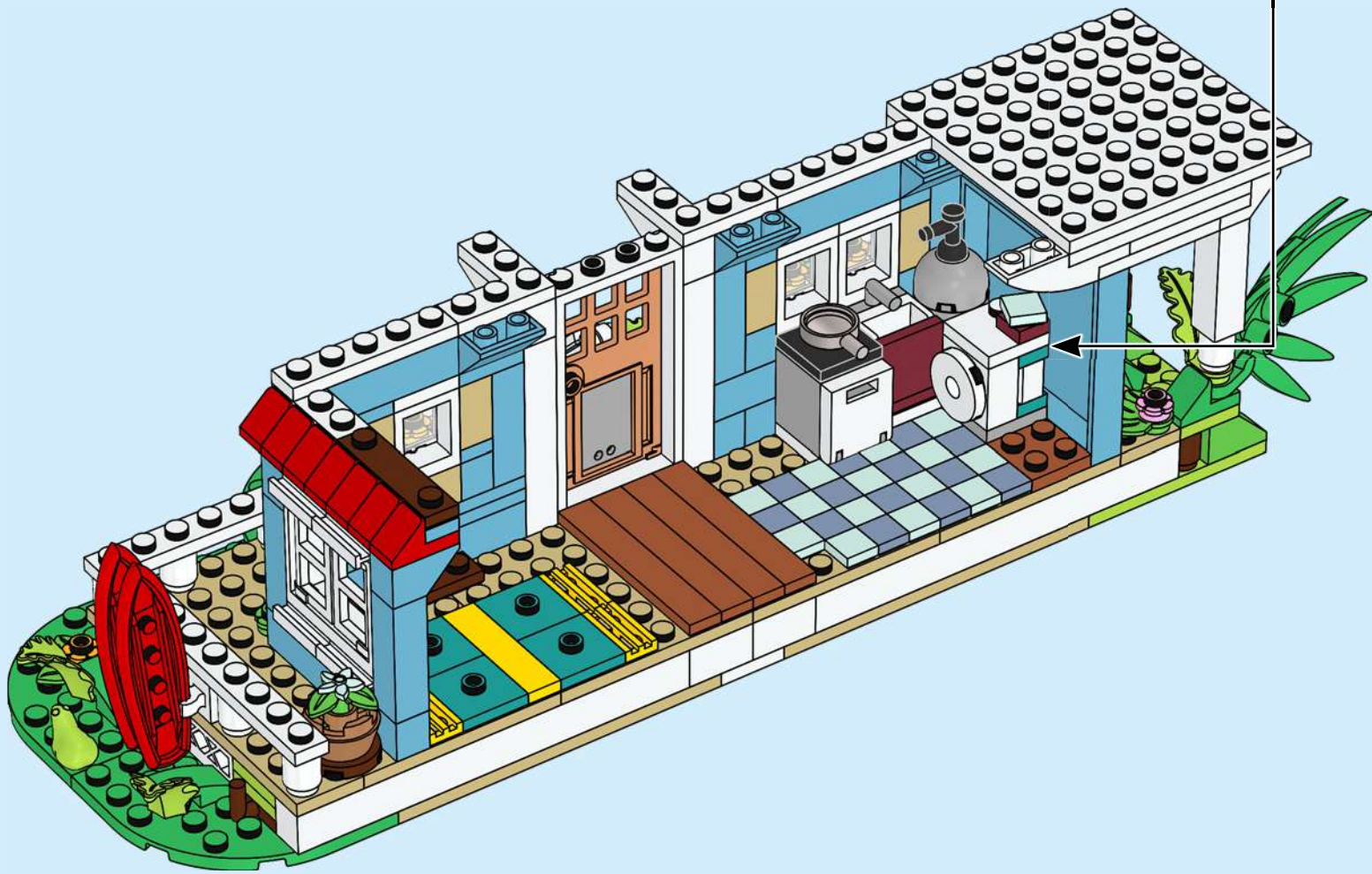
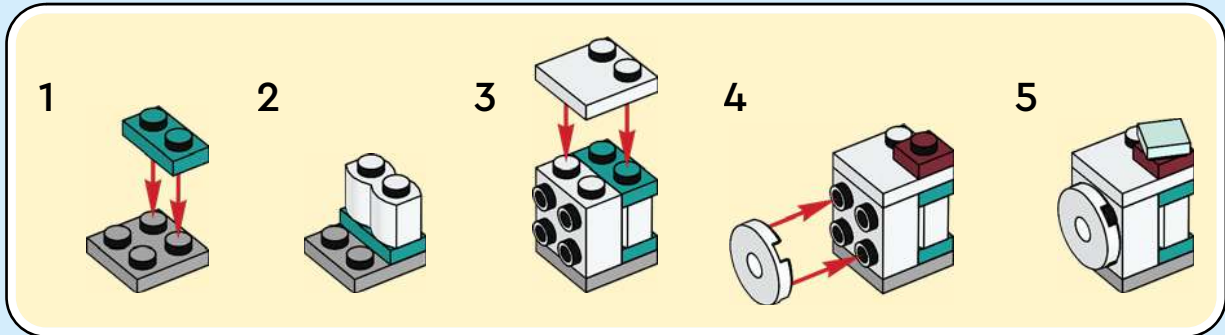

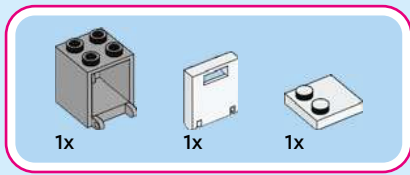

103

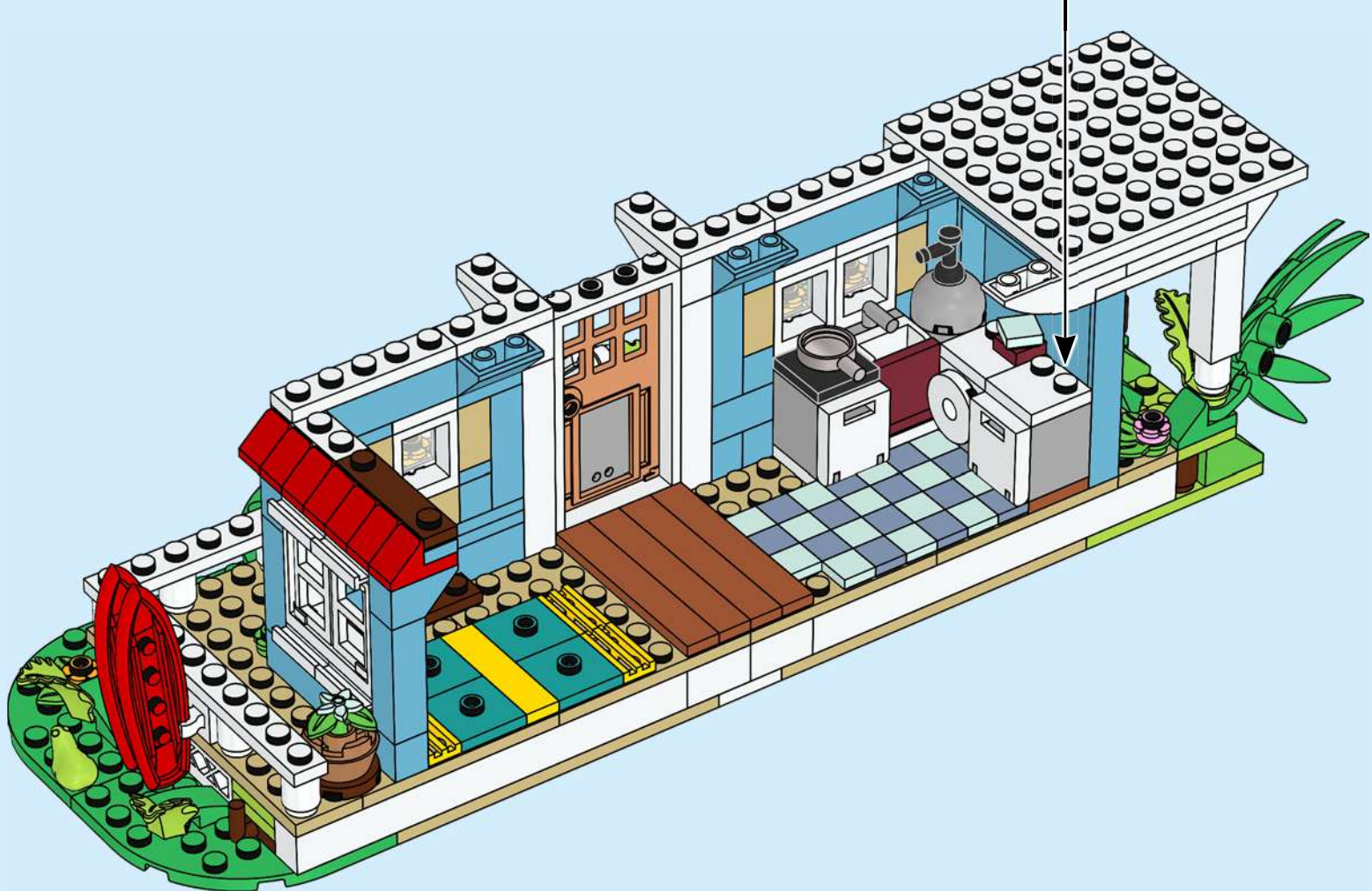
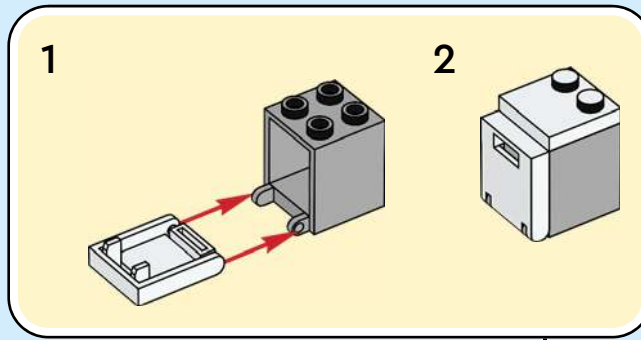



104

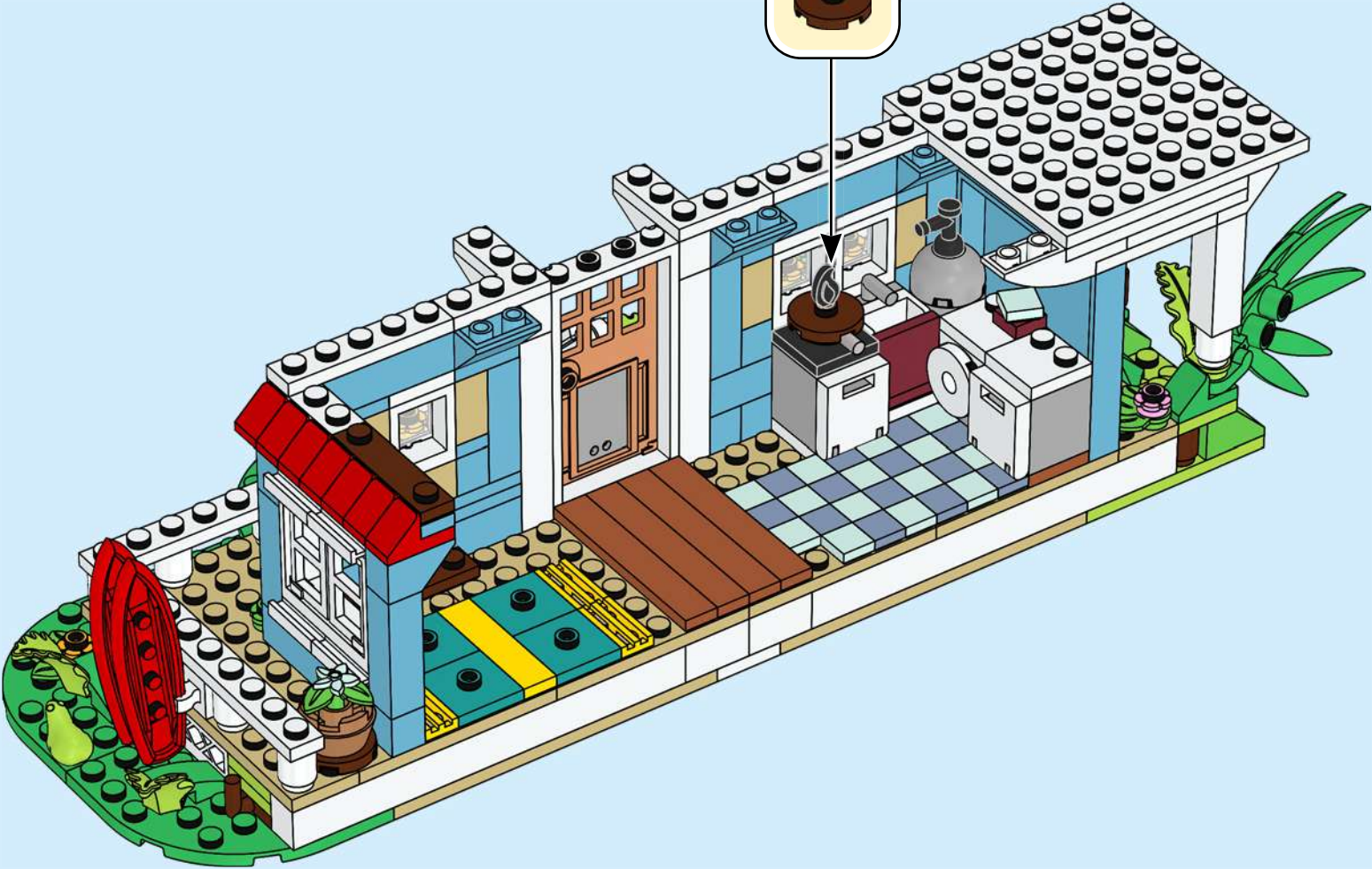

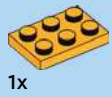

105

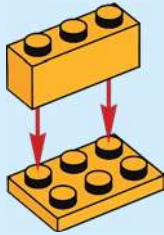

106

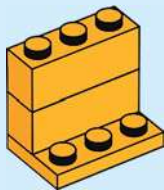

107

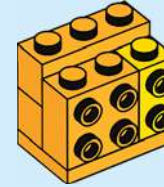

108

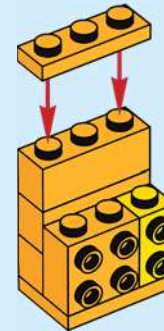



1x



1x

109

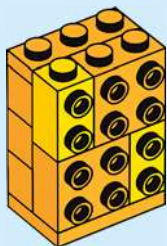

1x



1x

110

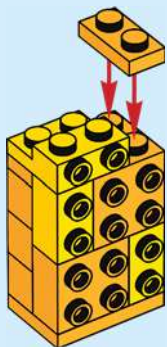

1x



1x

111



1x

112



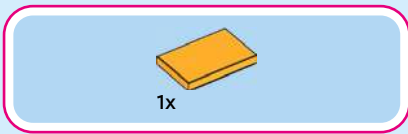

113

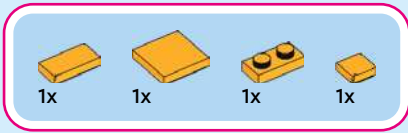
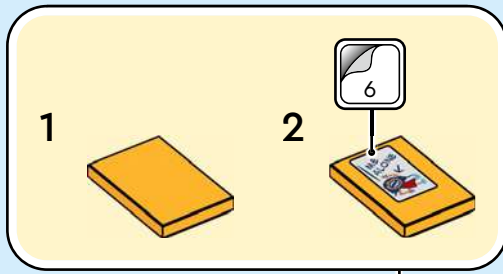

114

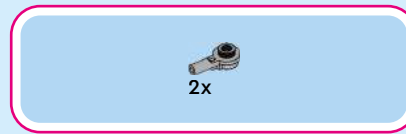

115



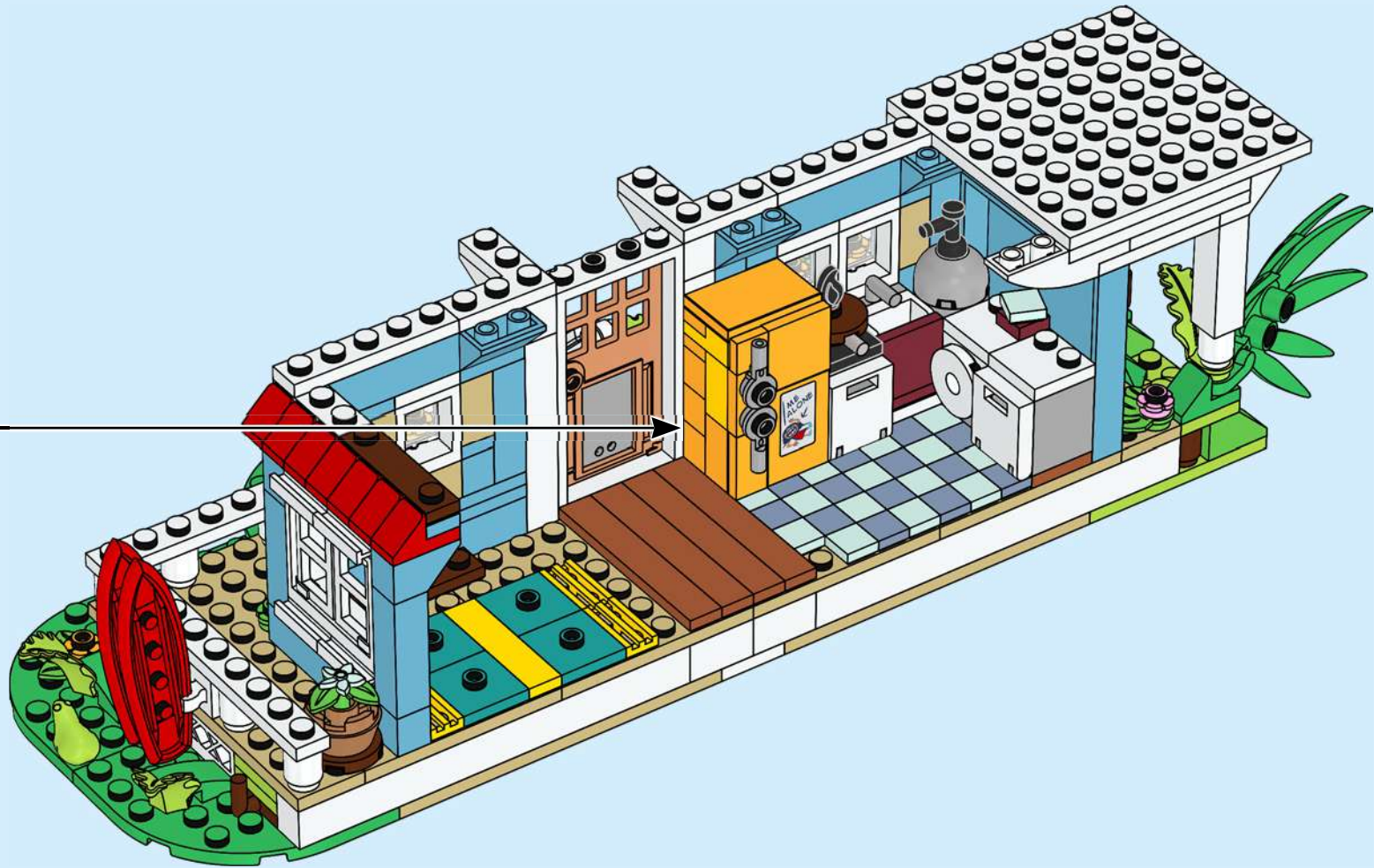



117

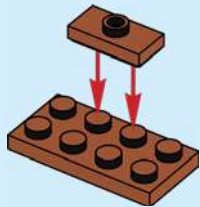

118

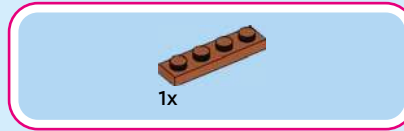

119

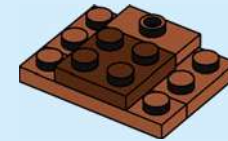

120



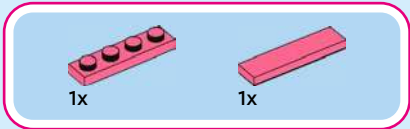

121



122



123

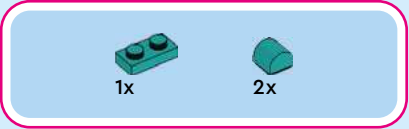
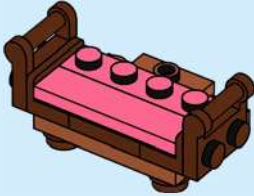

124

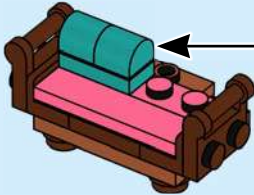
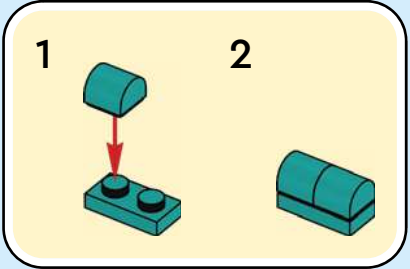

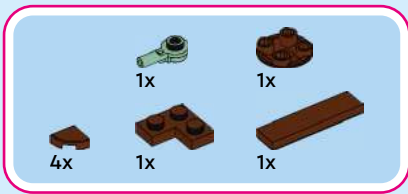

125

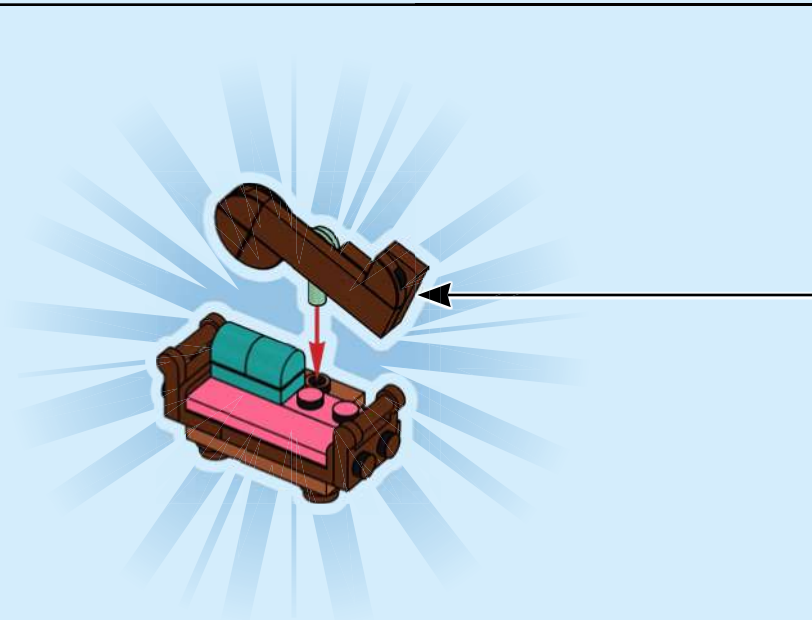
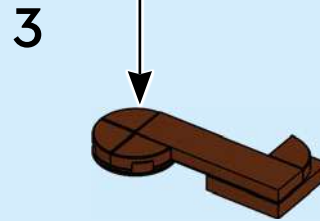
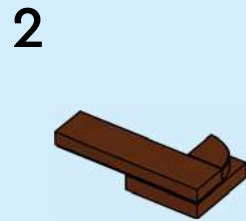
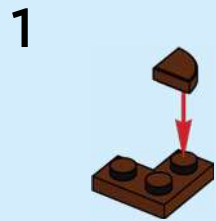
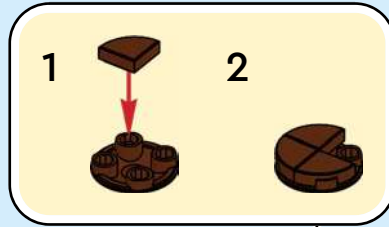

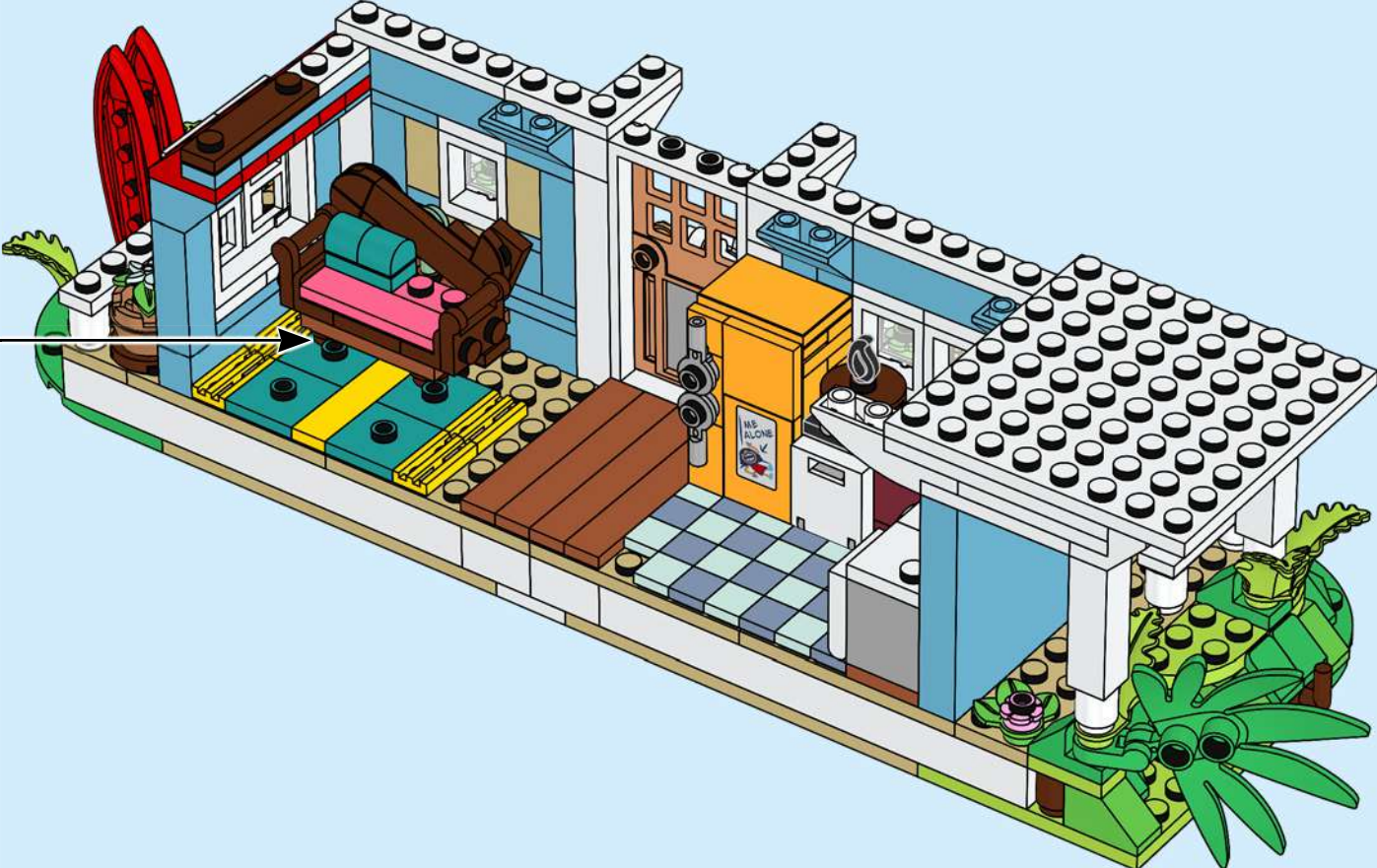

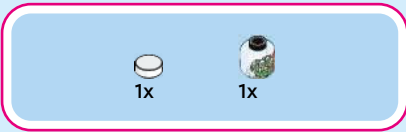

127

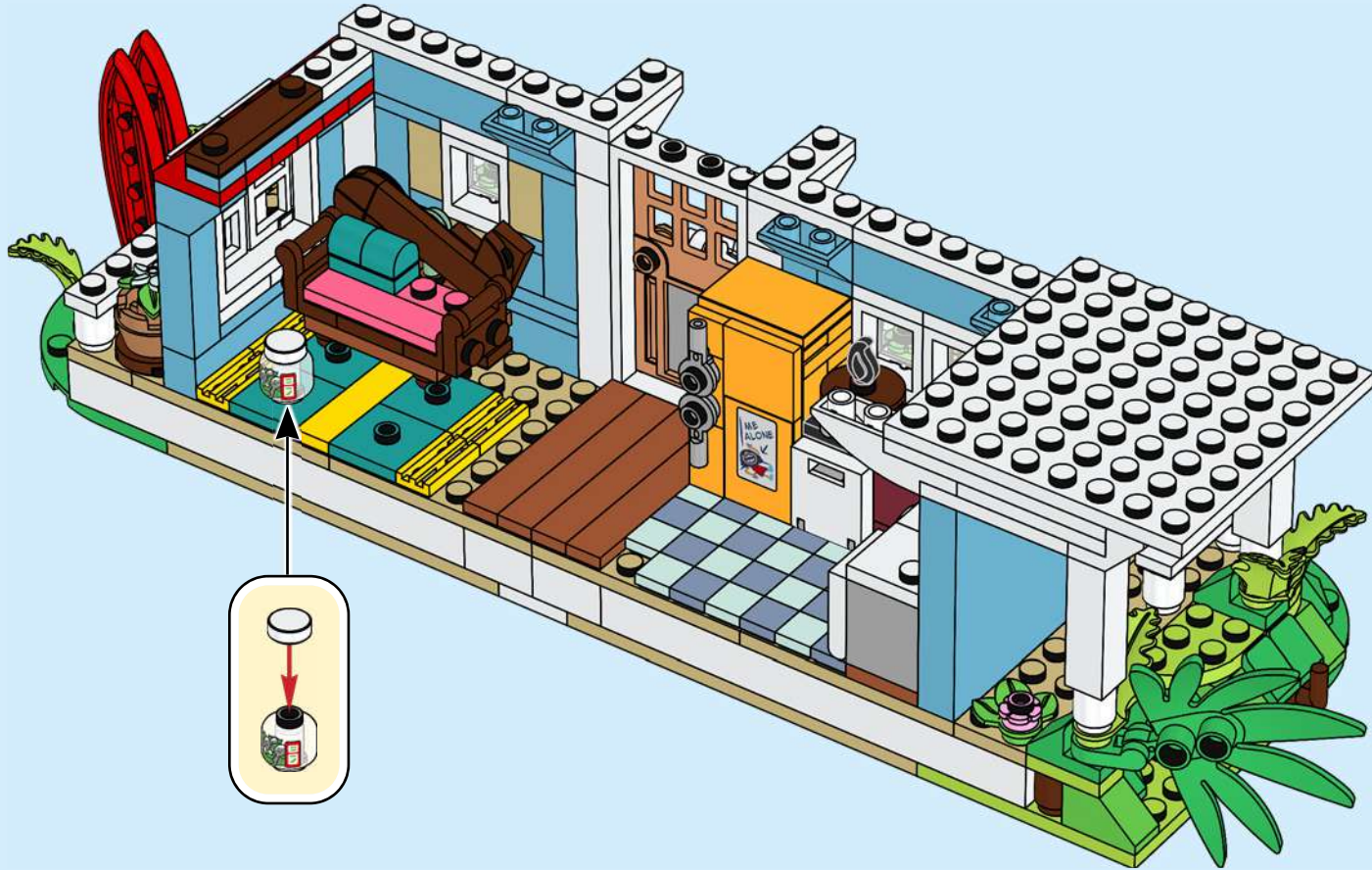

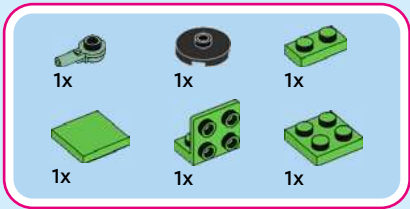

128

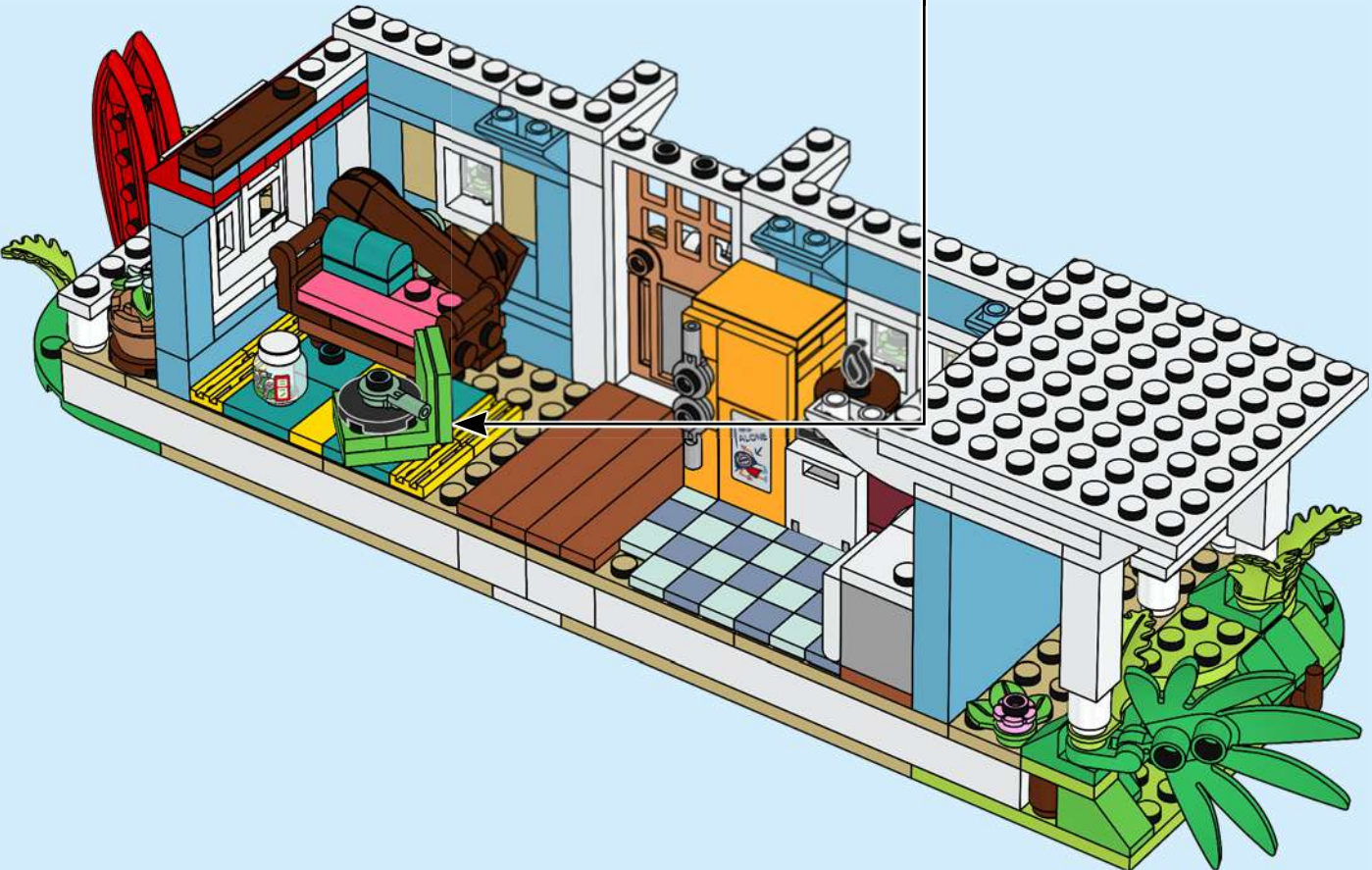
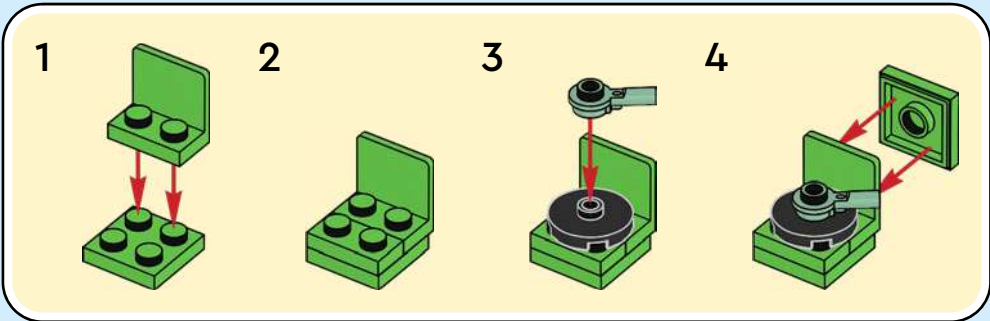

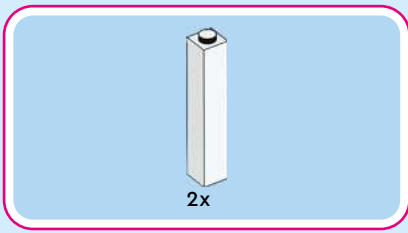

129

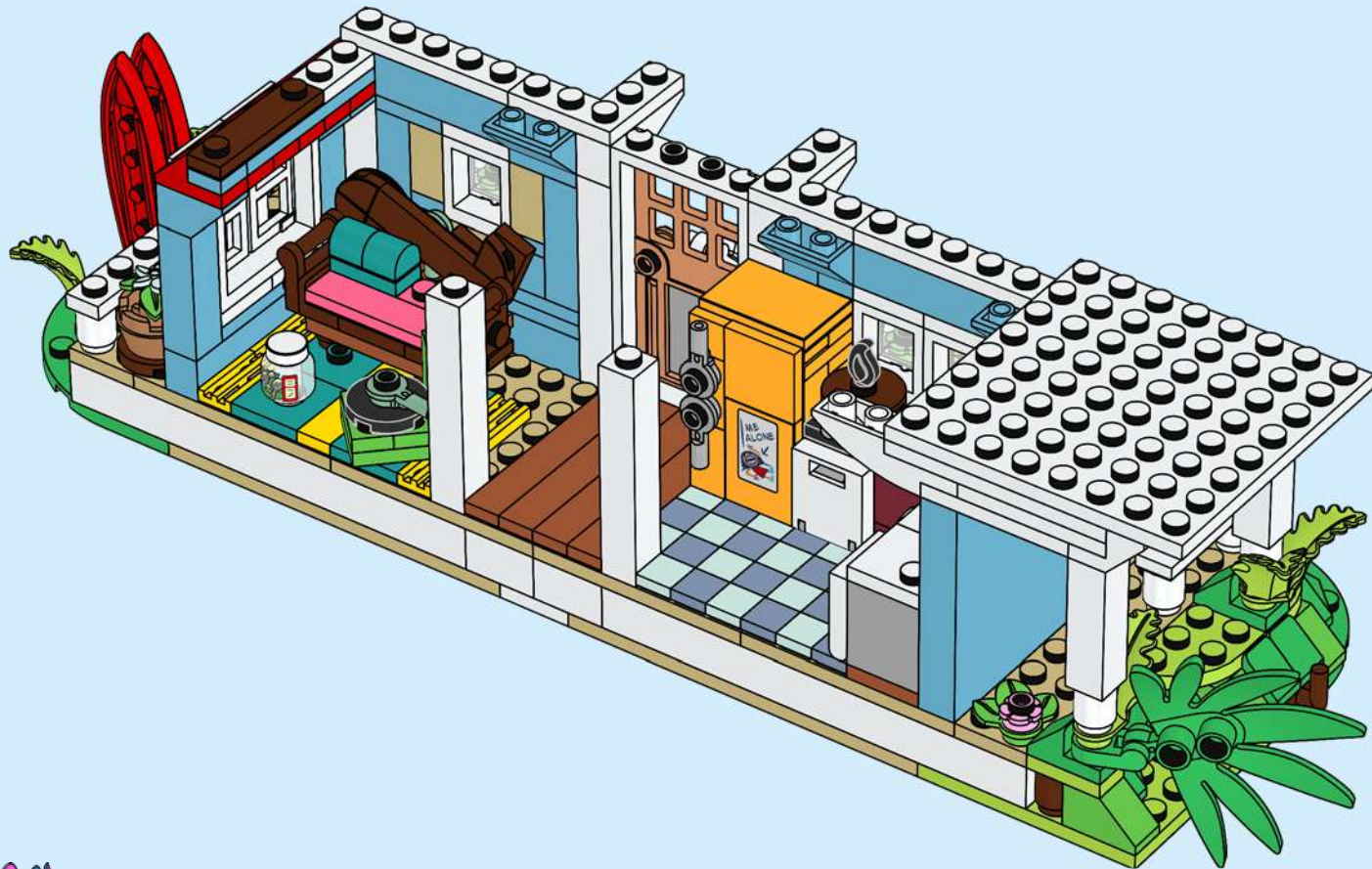

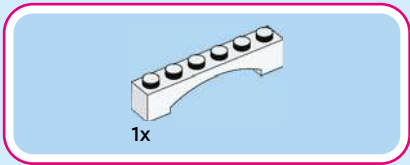

130

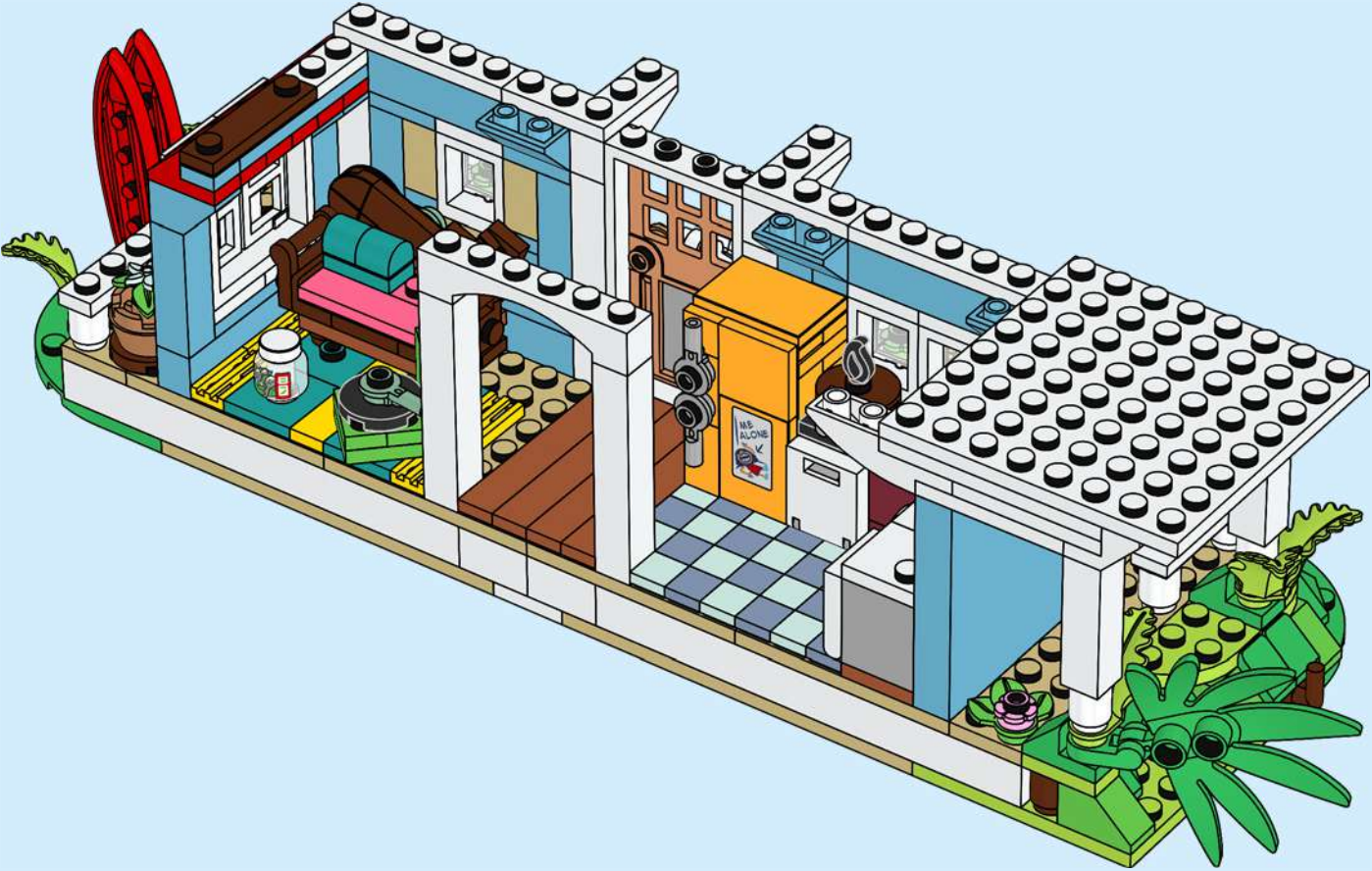

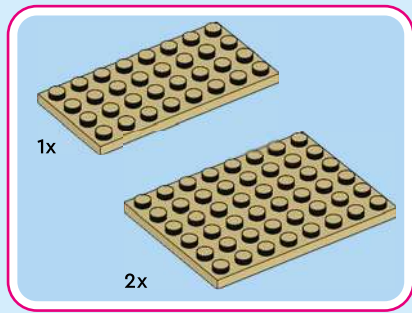

131

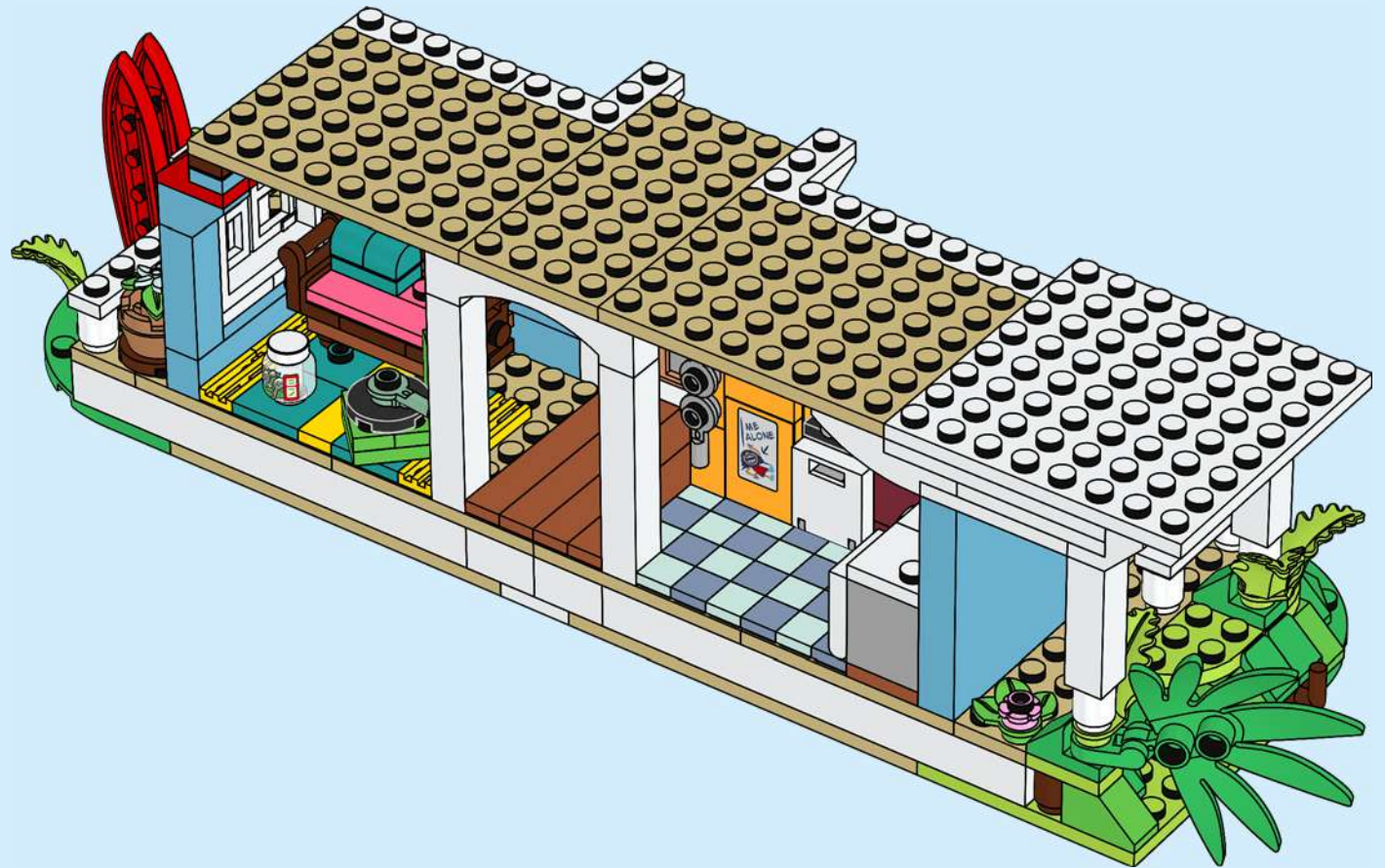

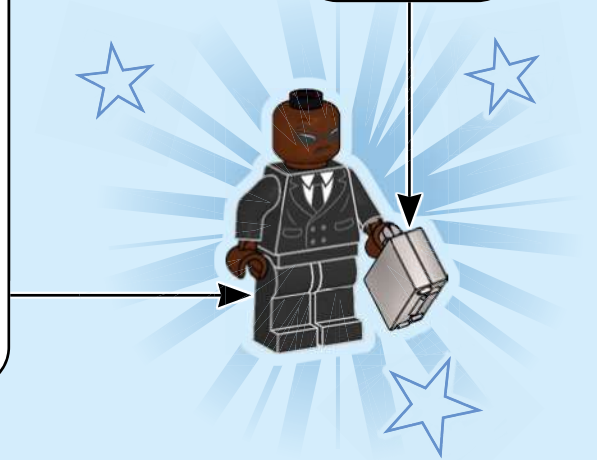
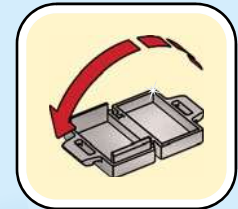
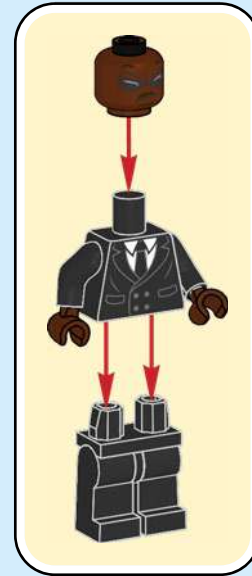



132

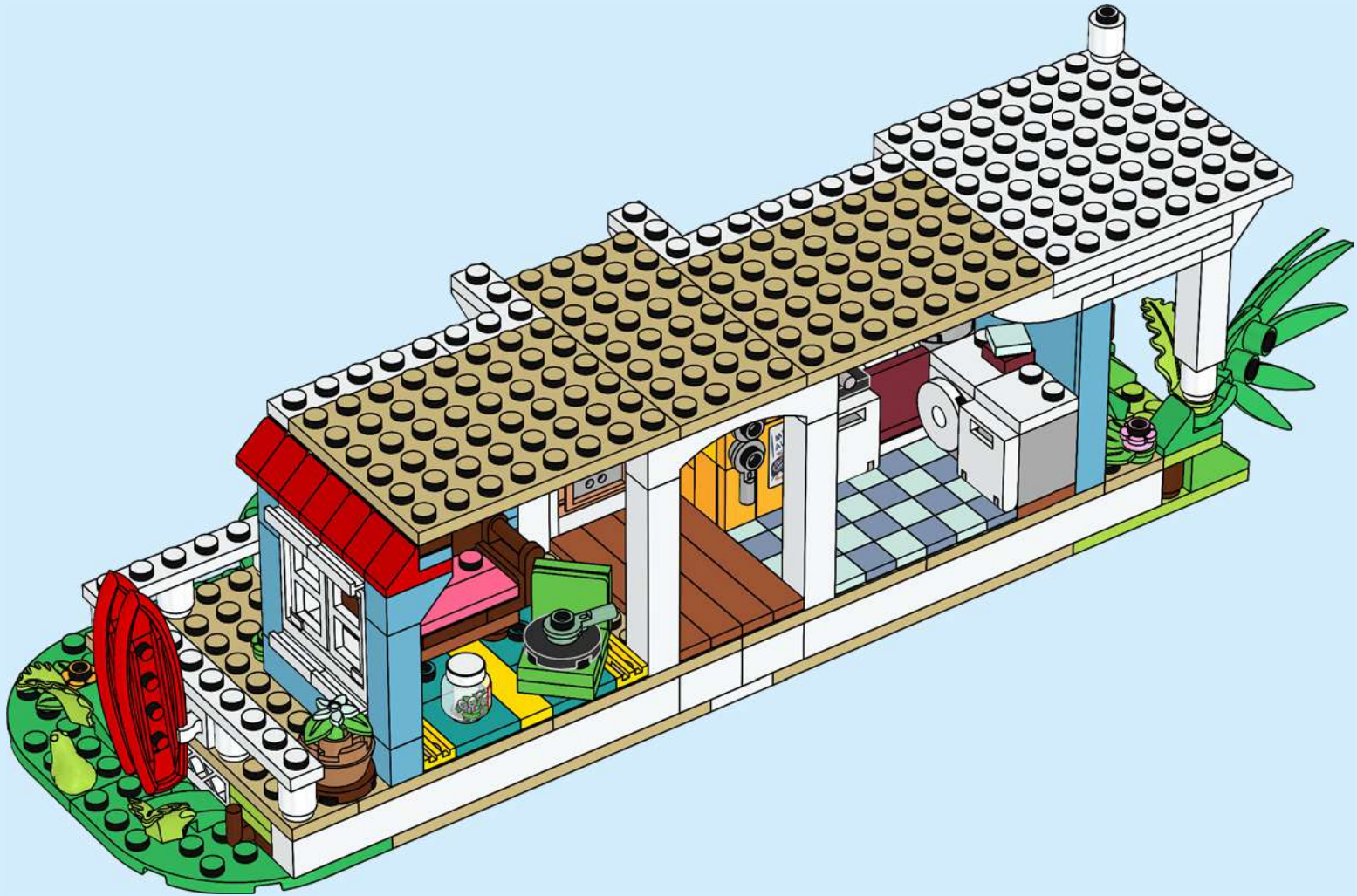

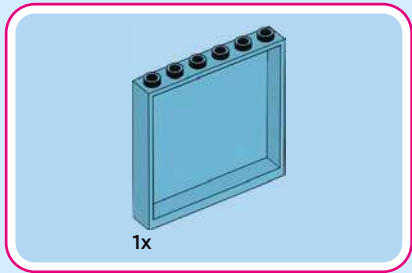

133

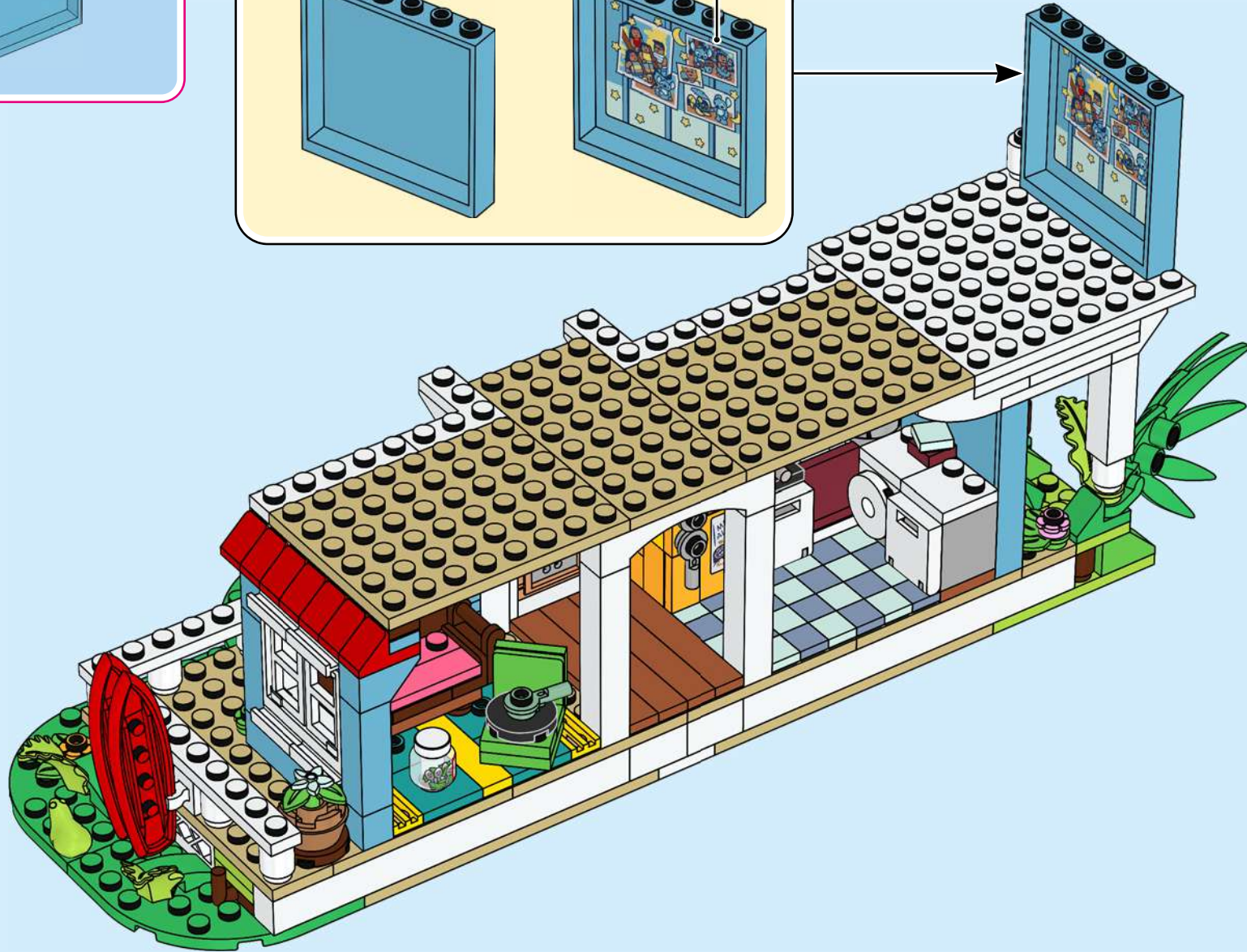
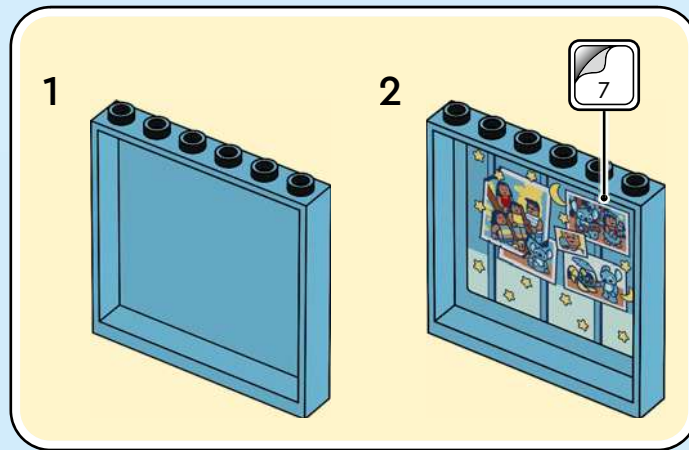

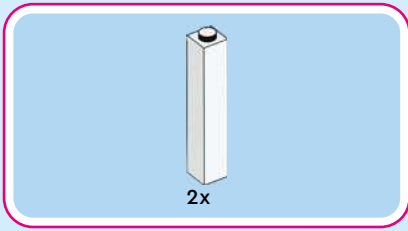

134



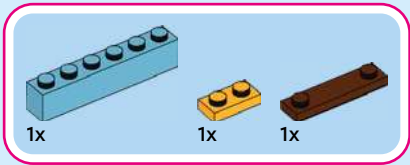

135



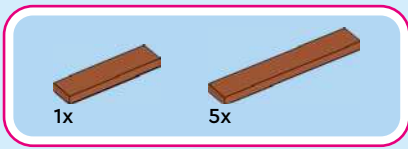

136



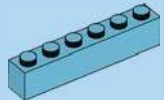

1x

137

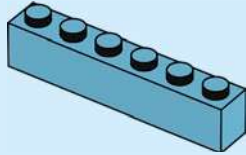

2x

138

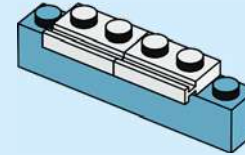

1x



2x

139

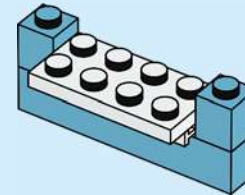

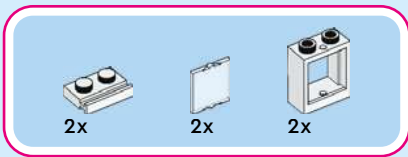

140

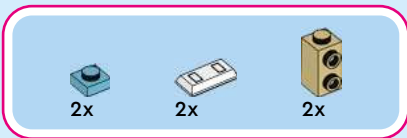
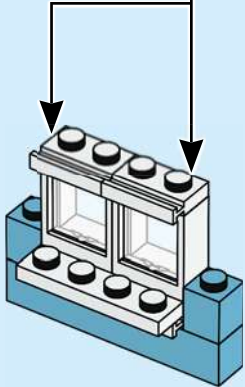
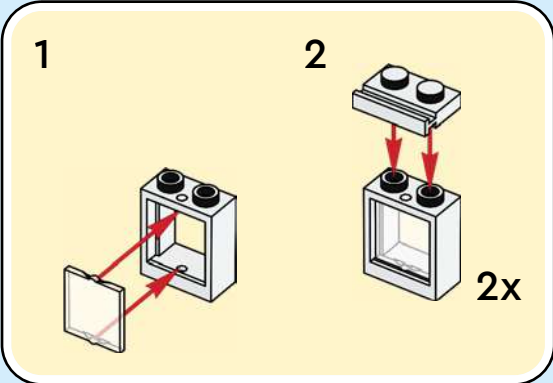

141

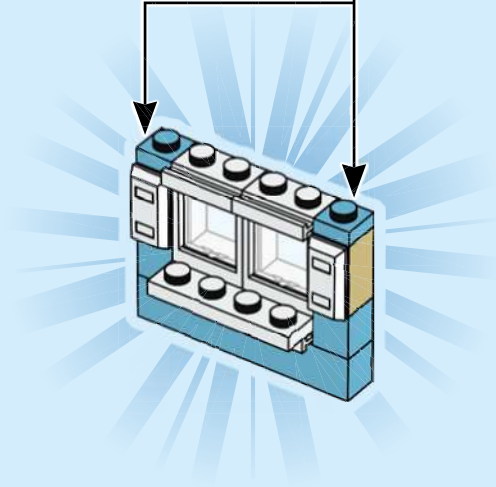
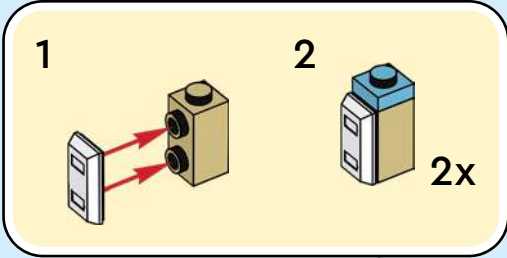

142

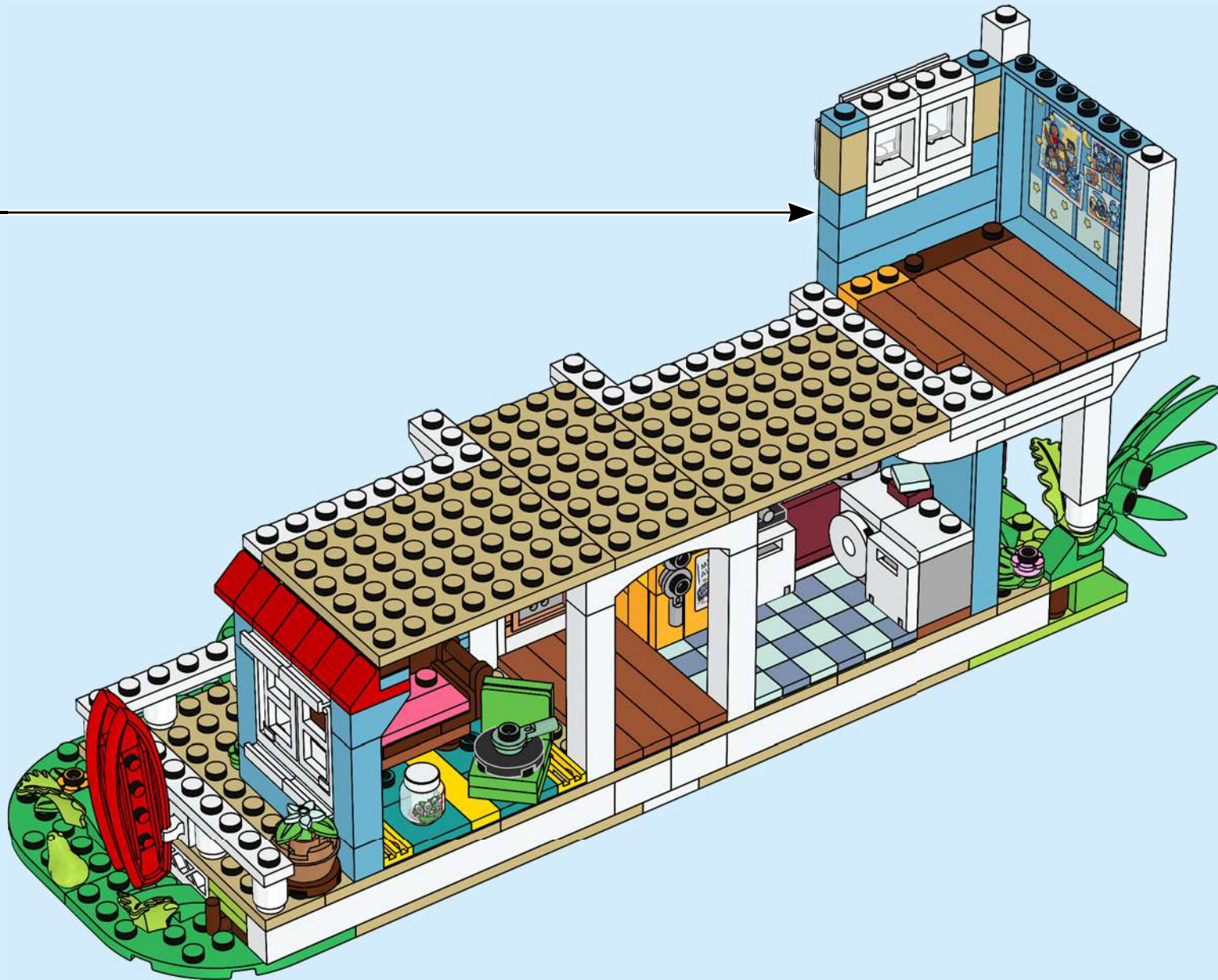

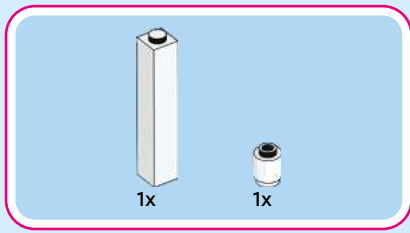

143



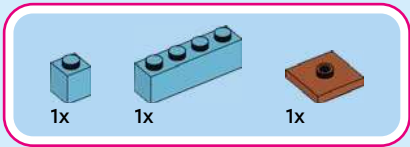

144



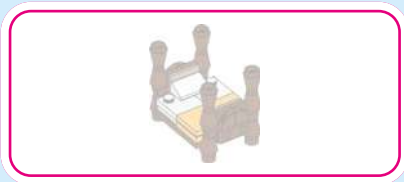

145

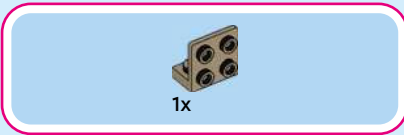
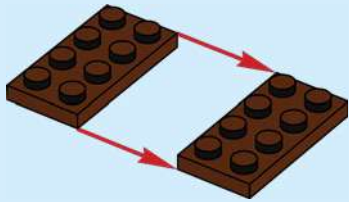

146



147

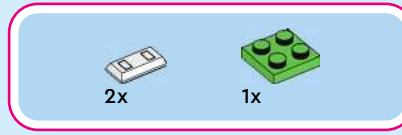

148





1x

149



1x



2x

150

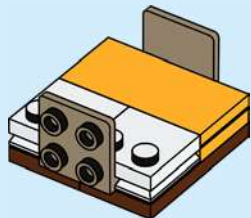

2x

151

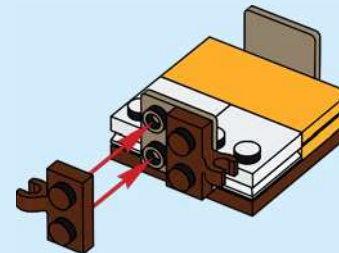

2x



1x

152

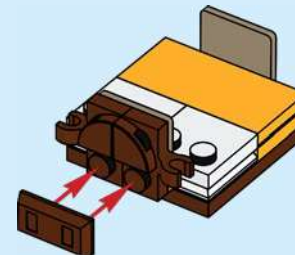

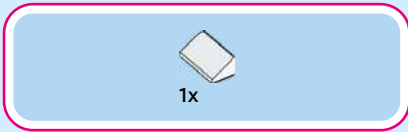

153



154

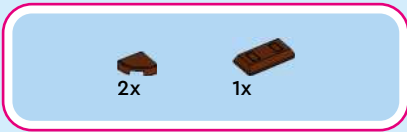
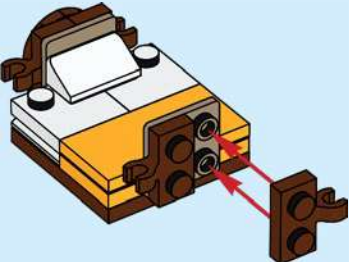

155

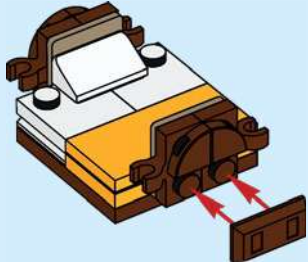



156

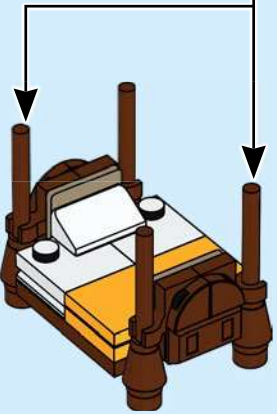
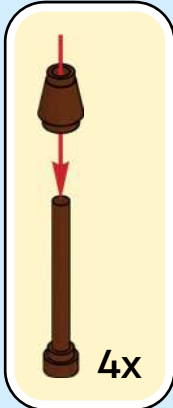

157

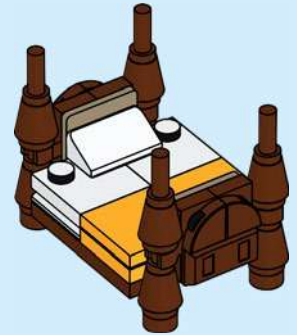

158



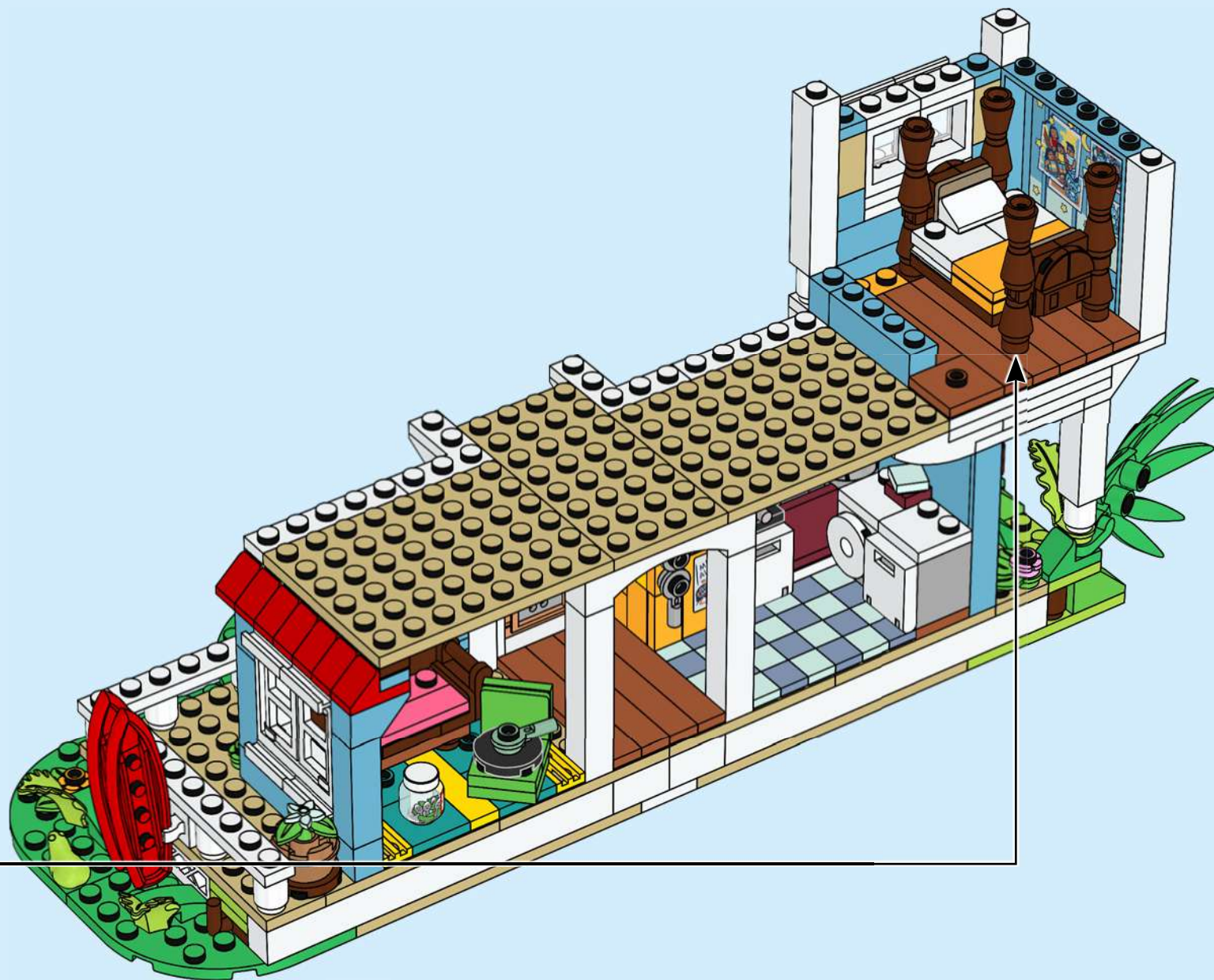

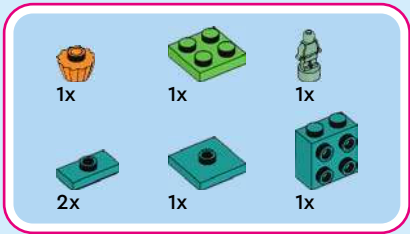

160

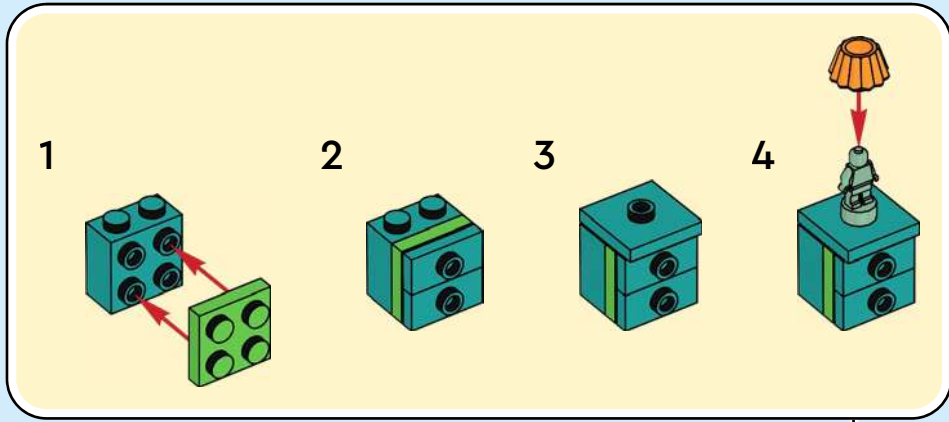

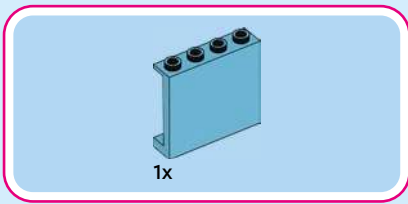

161



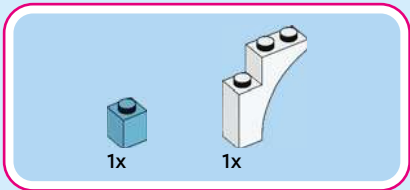

162

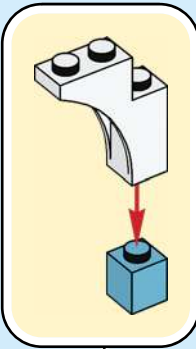

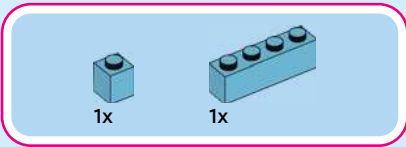

163



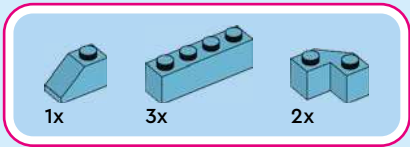

164



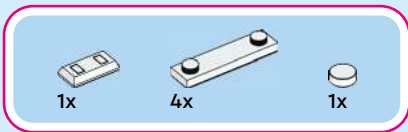

165



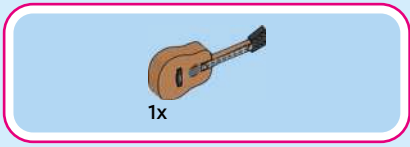

166

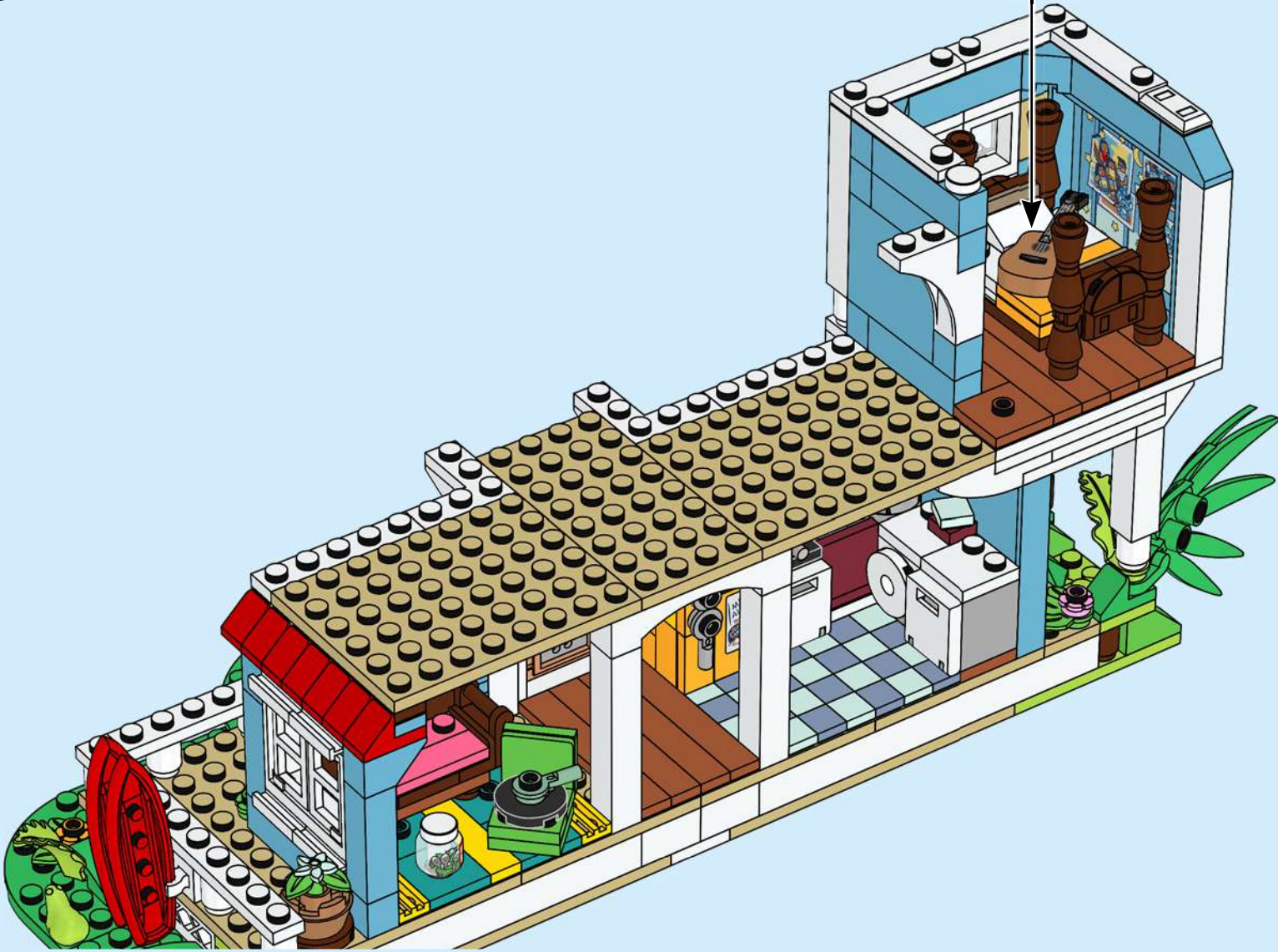

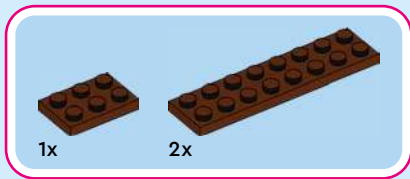

167



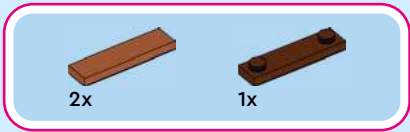

168



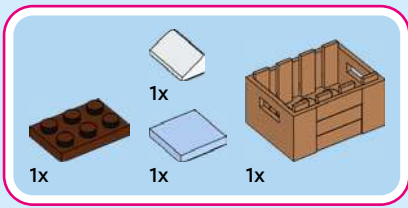

169

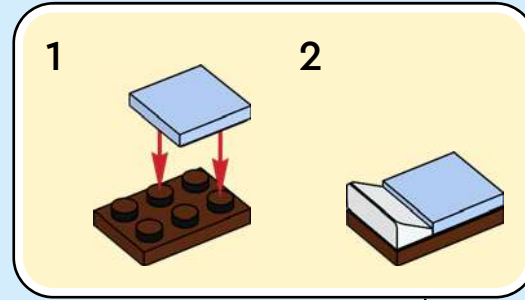

1

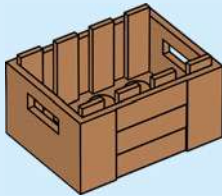

2

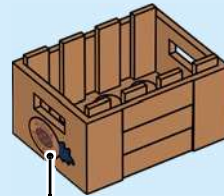

3

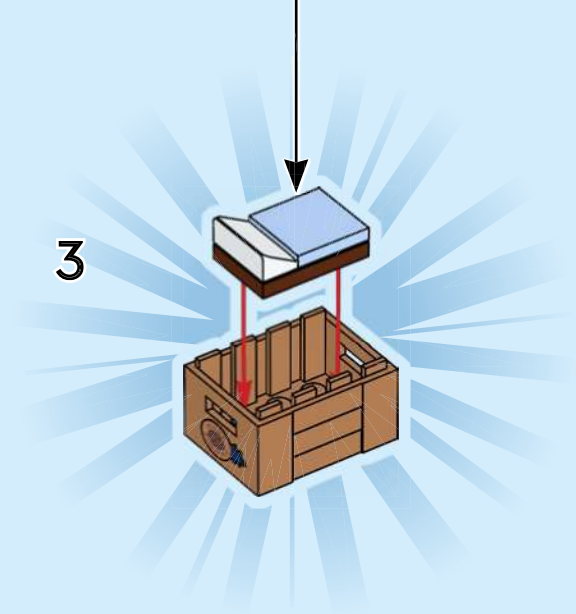

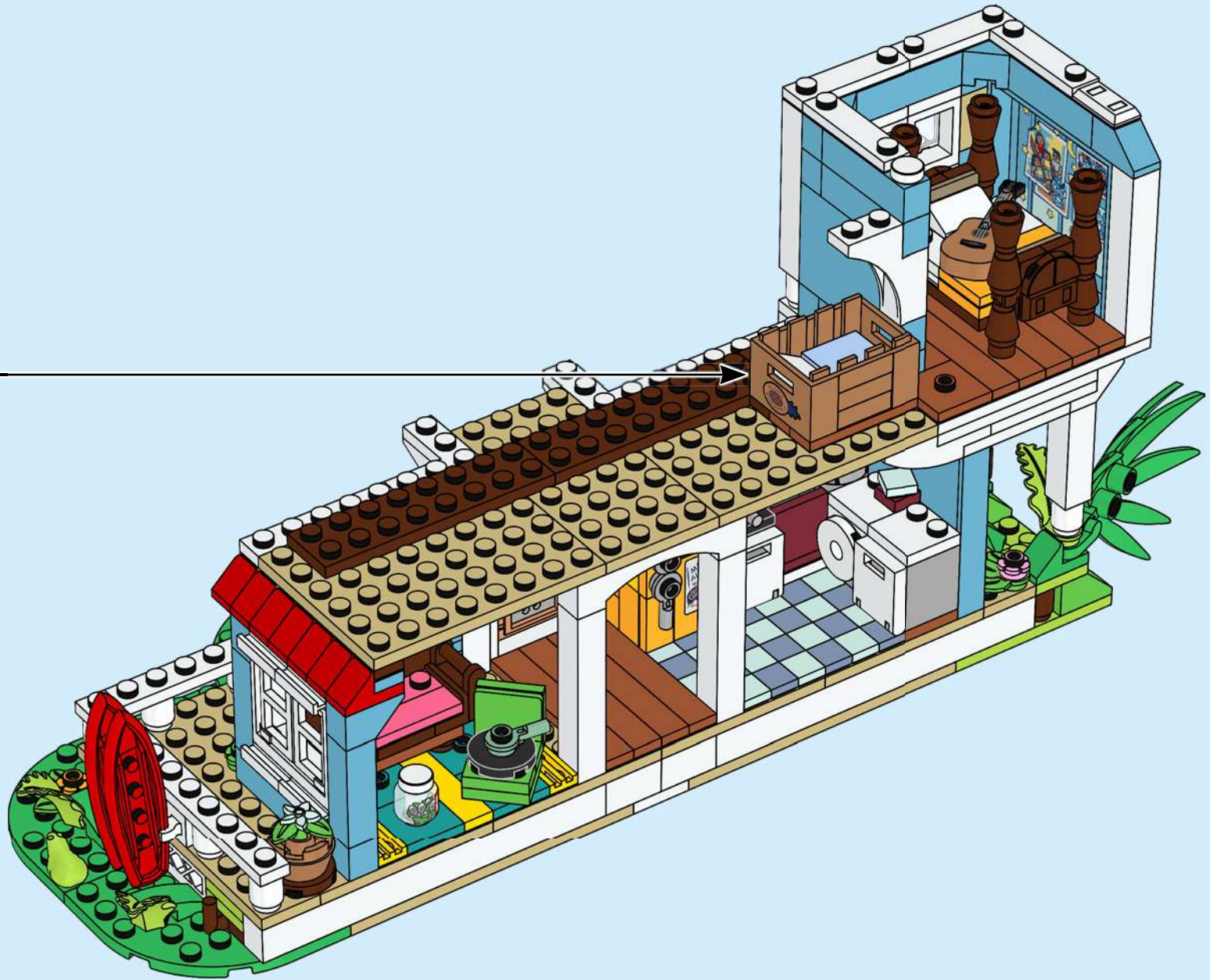

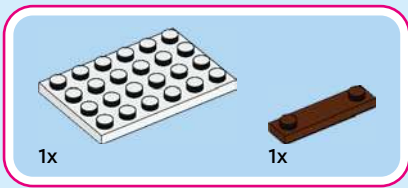

170





2x

171



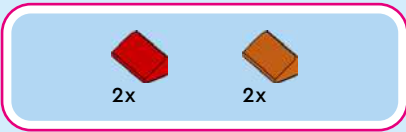

172



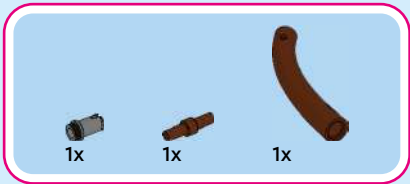

173

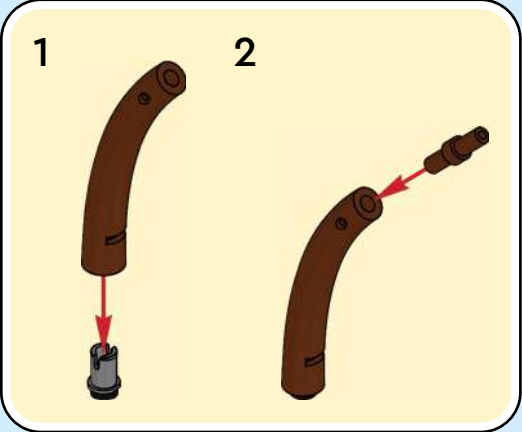



174

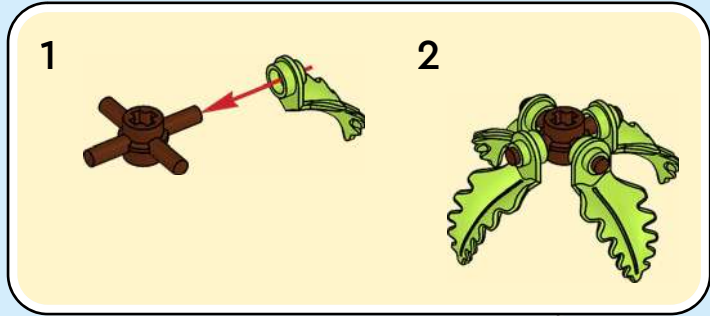







1x

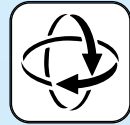

1x

175



| | | |
|----------------------------------------------------------------------------------|----------------------------------------------------------------------------------|----------------------------------------------------------------------------------|
|  |  |  |
| 2x | 1x | 1x |

176

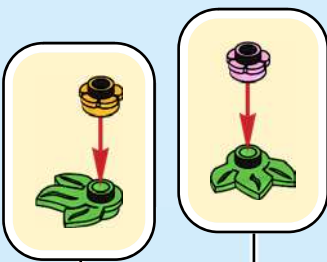

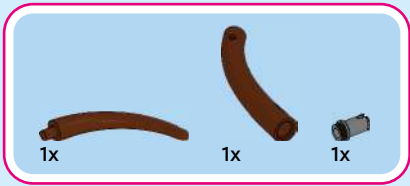

177

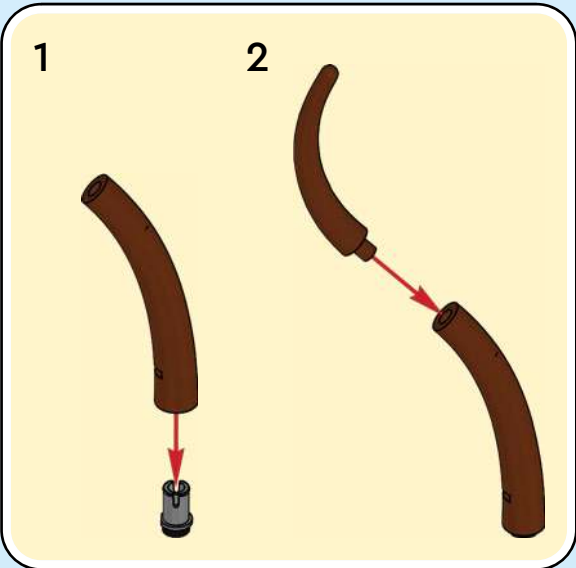



178

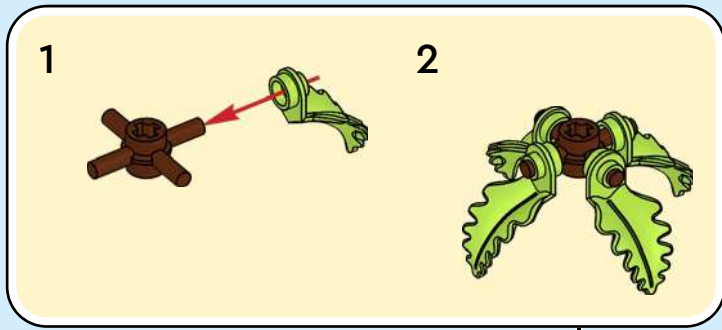

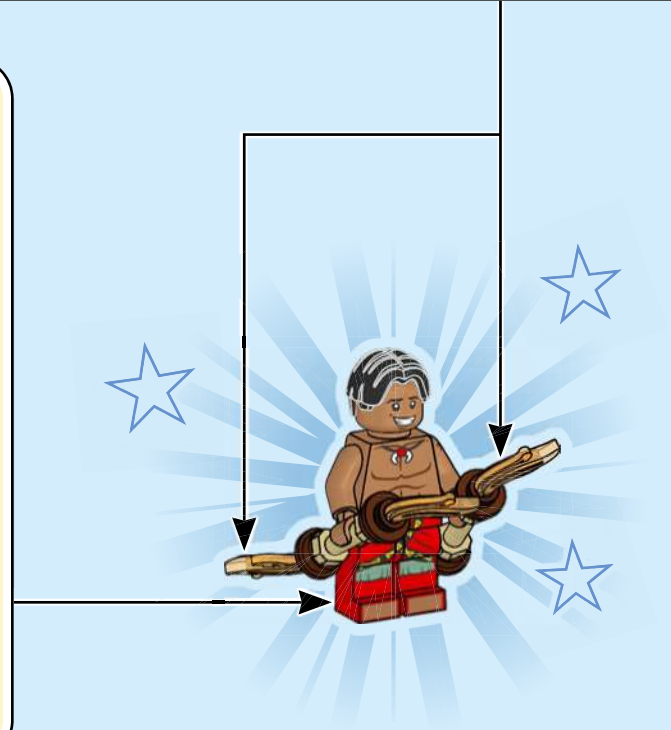
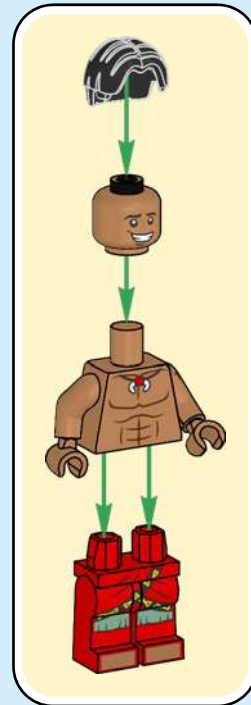
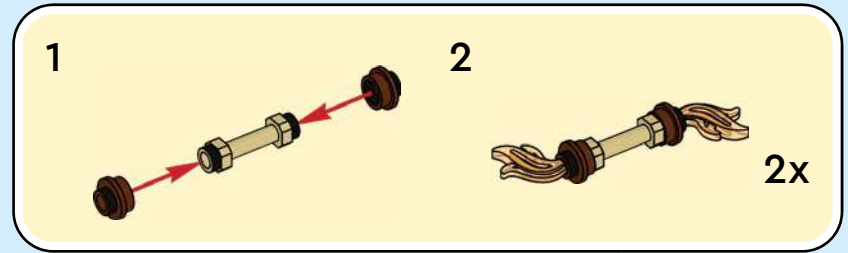

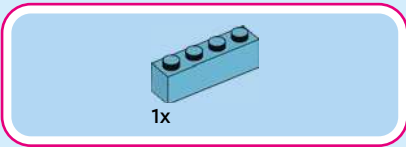

179

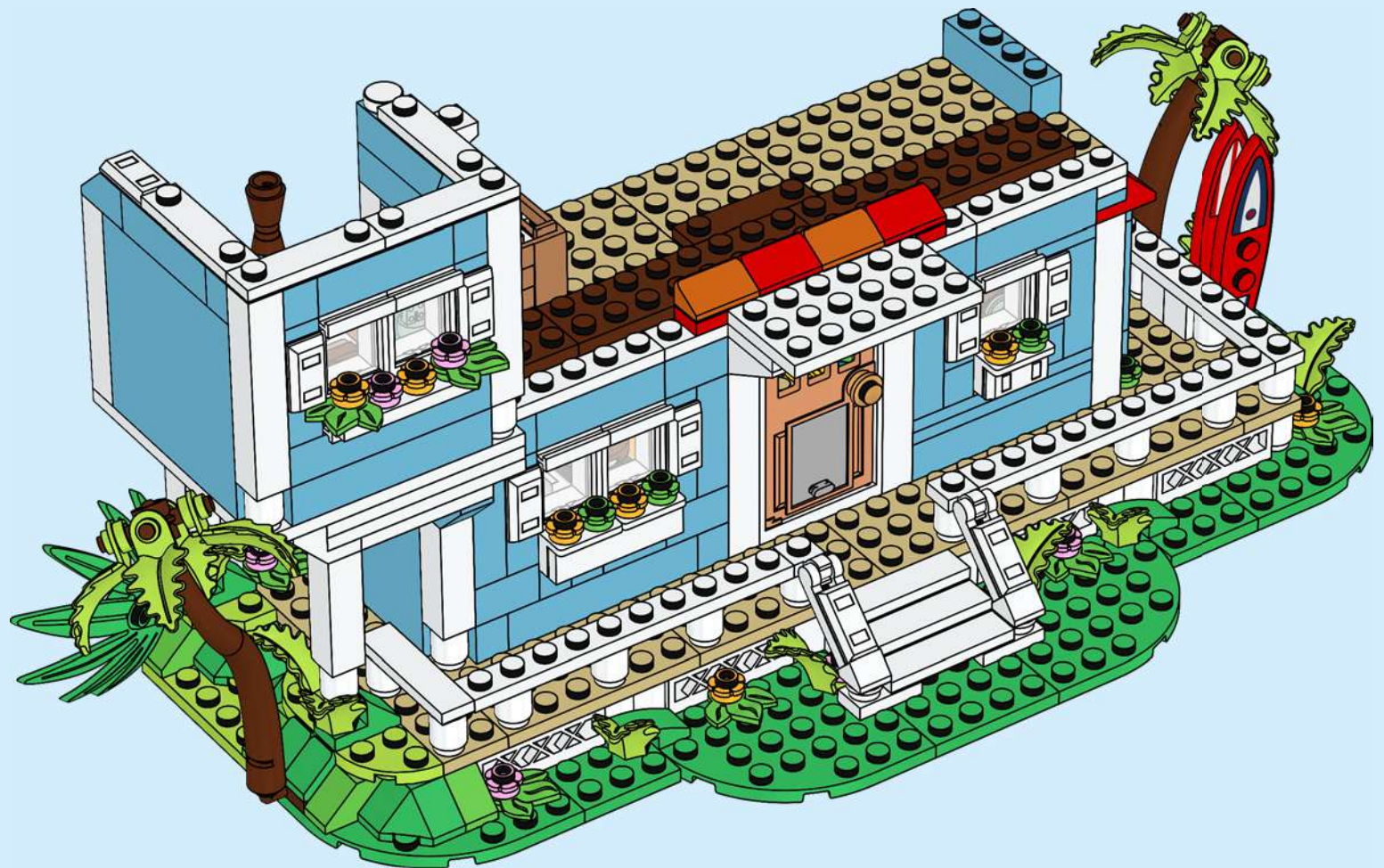

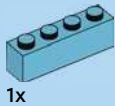

1x



1x

180

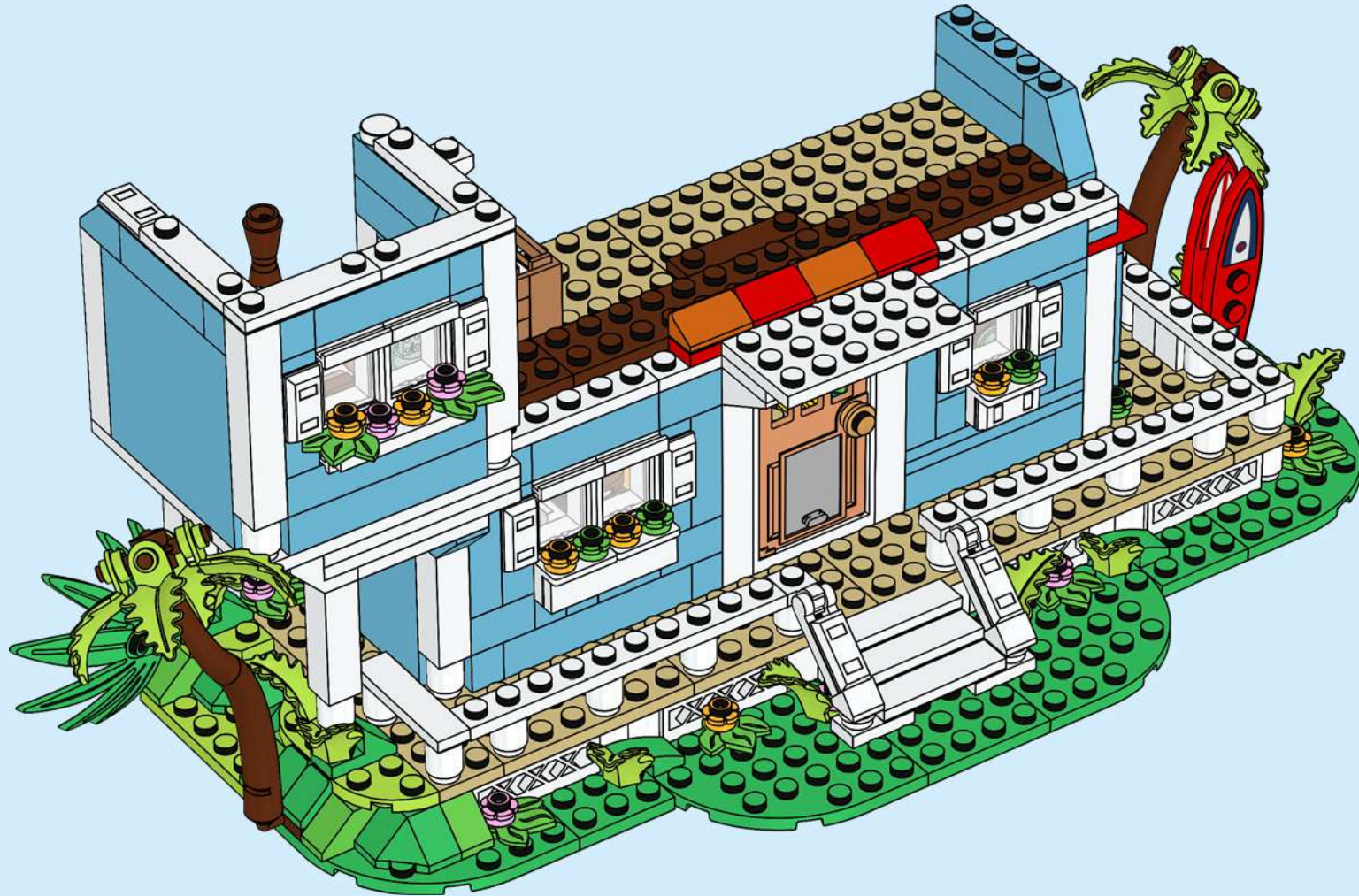

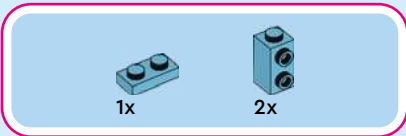

181



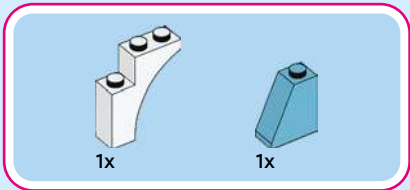

182

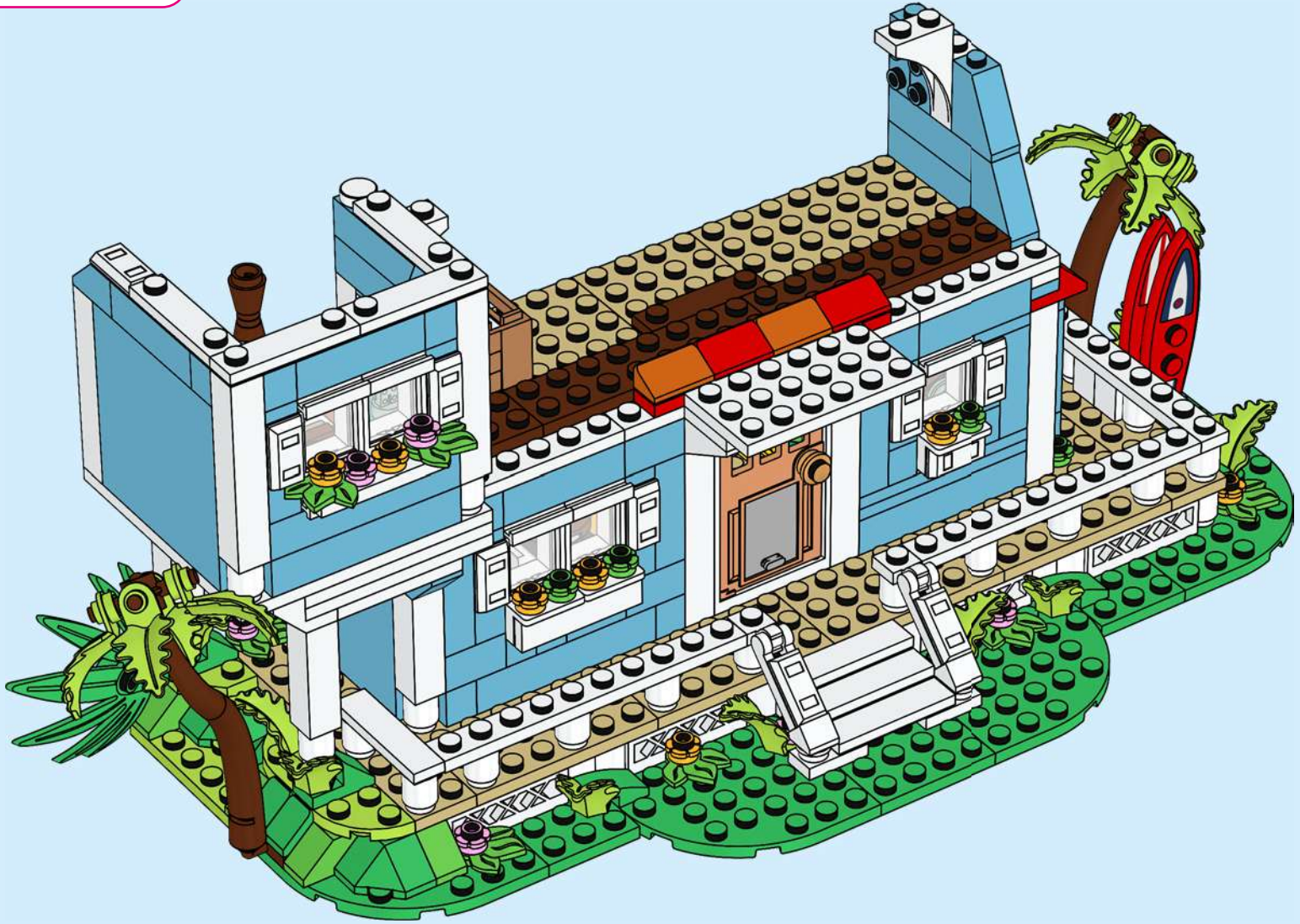

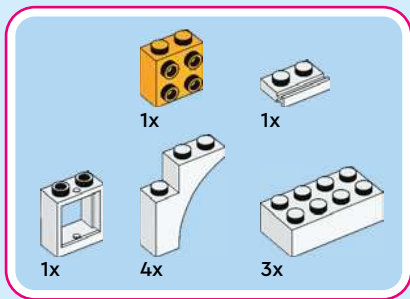

183

1

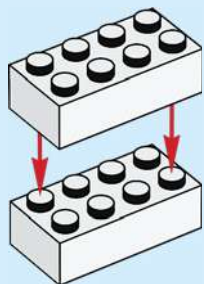

2

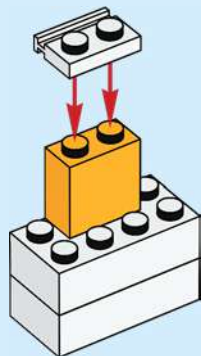

3

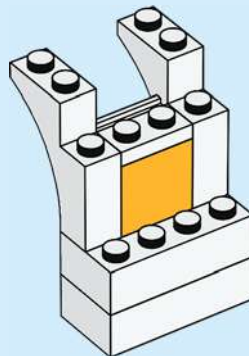

4

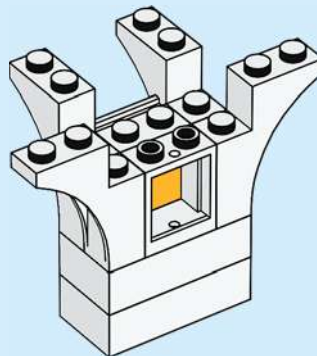

5

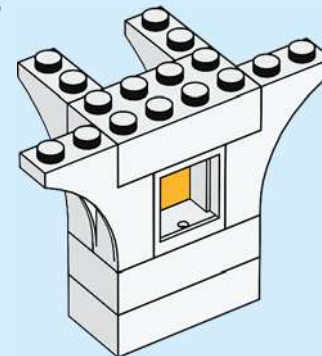

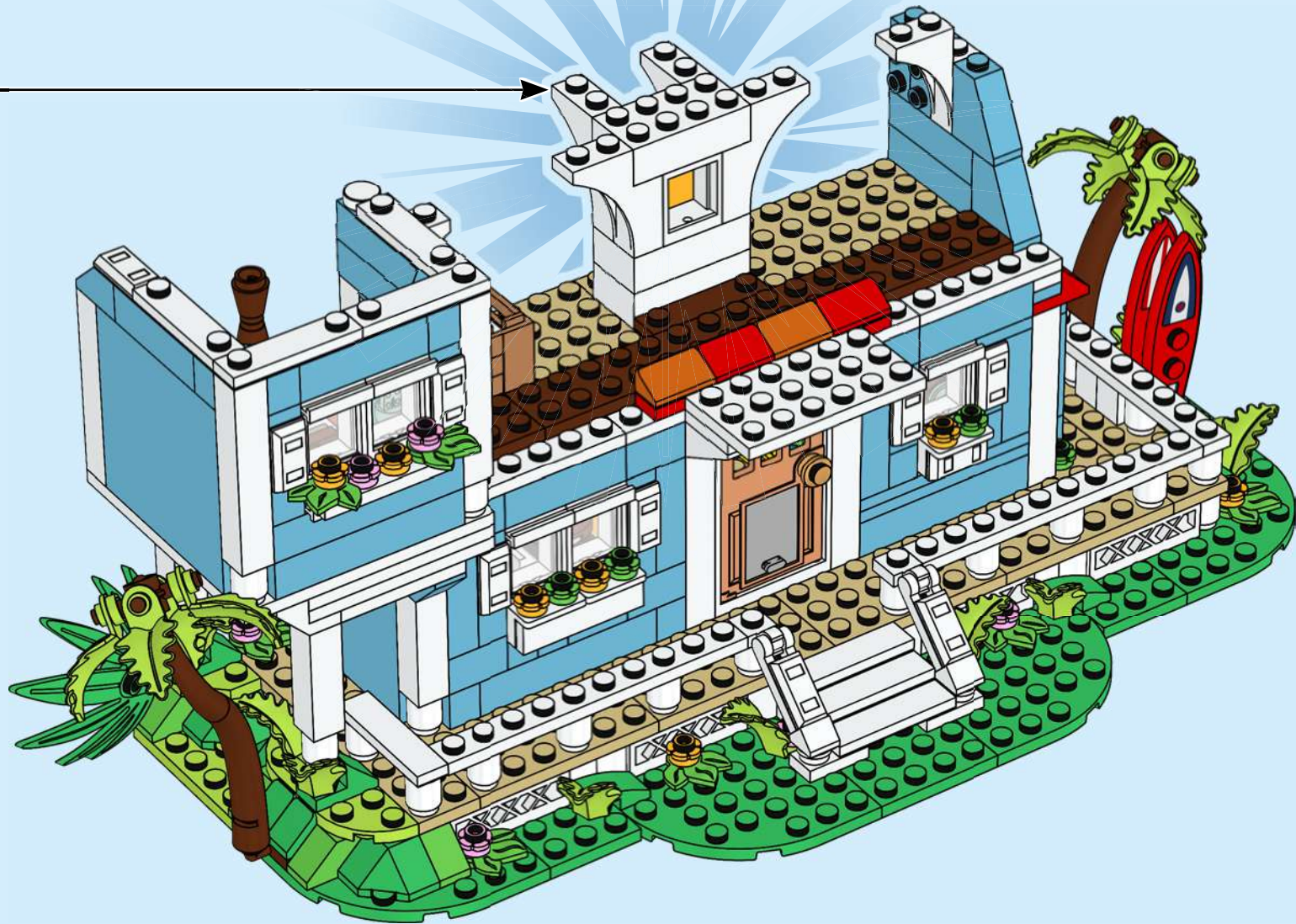

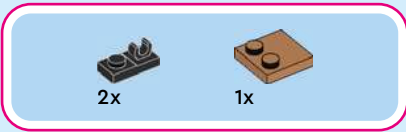

184

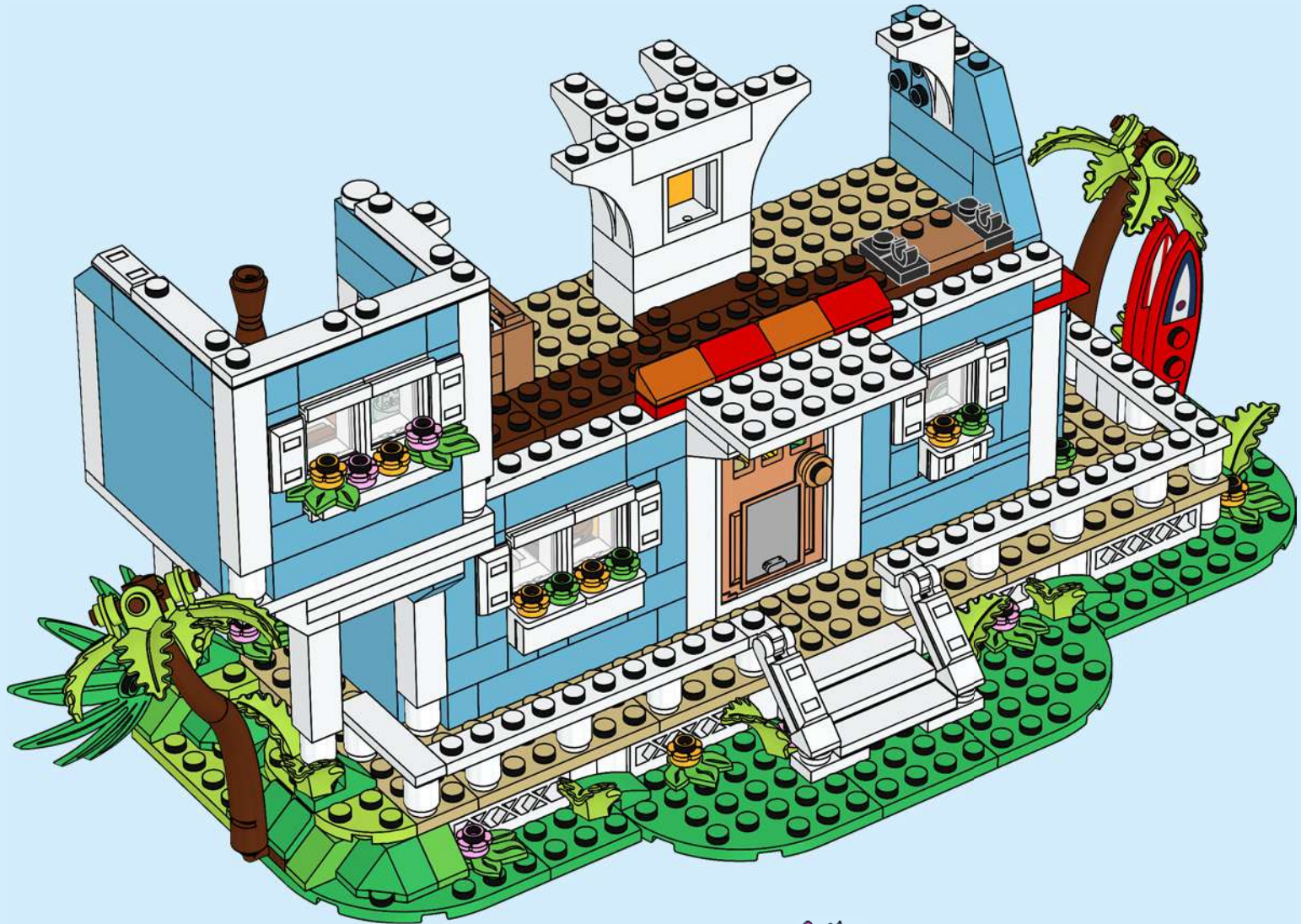



185

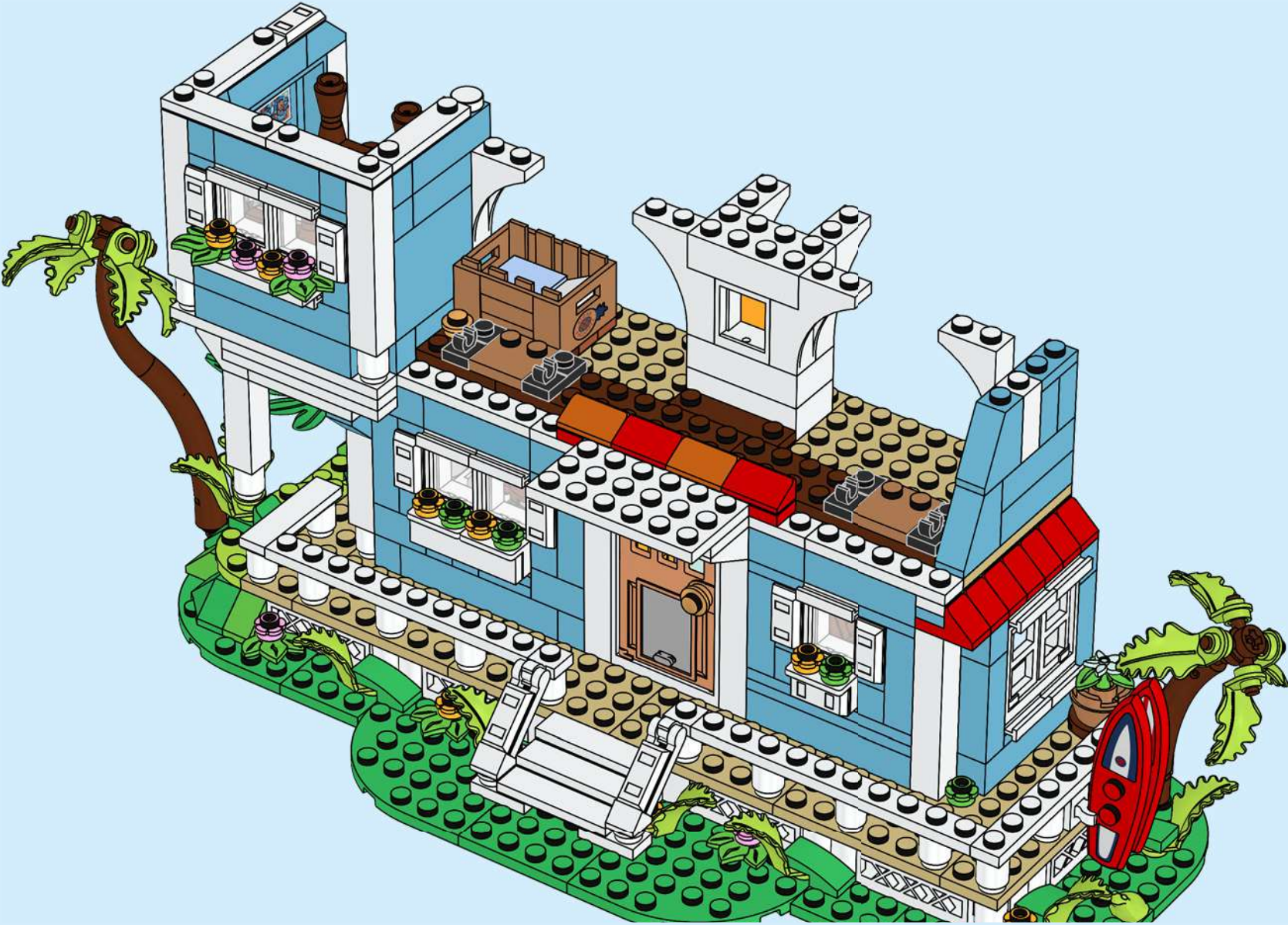



2x

186

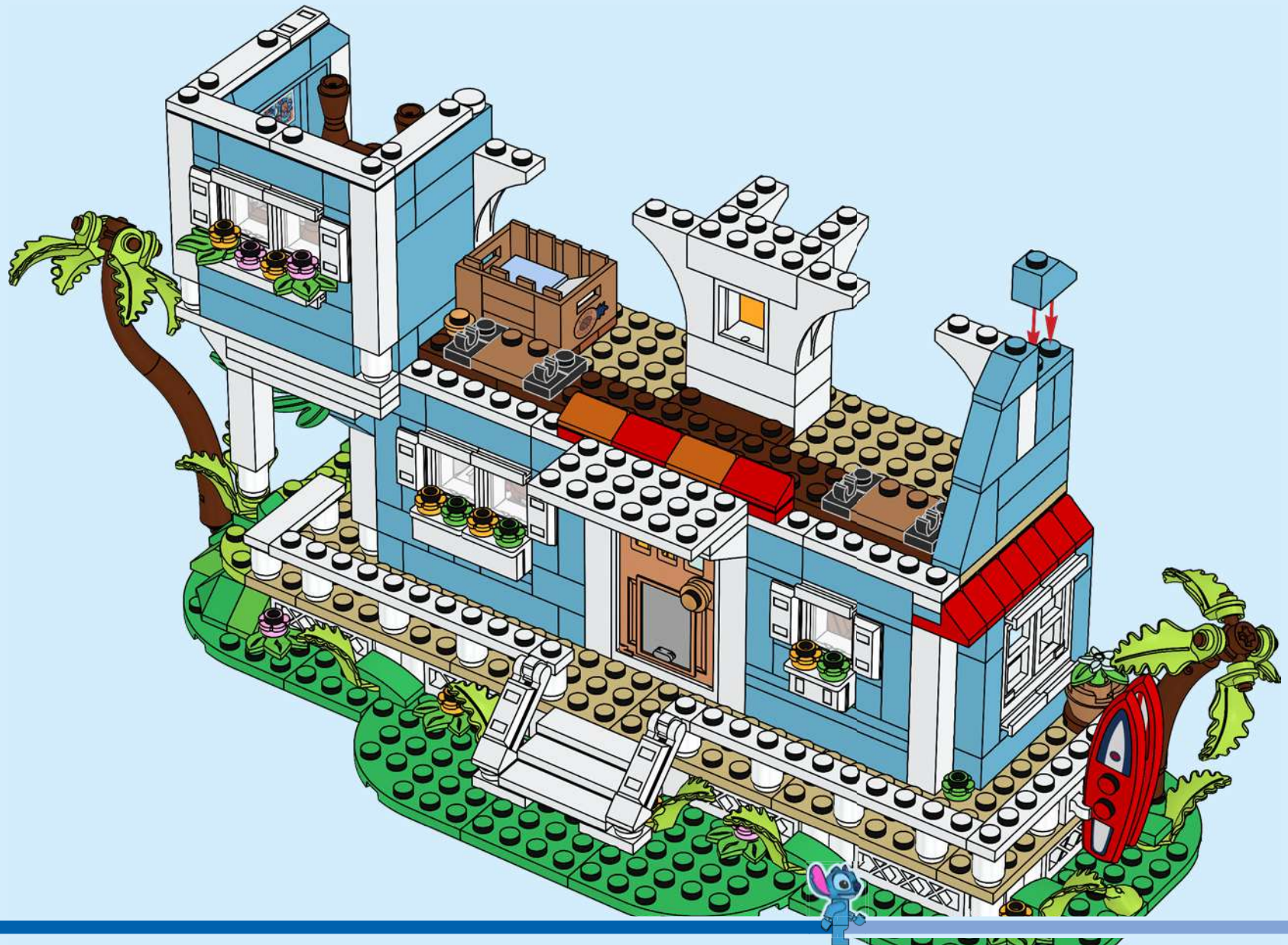



187

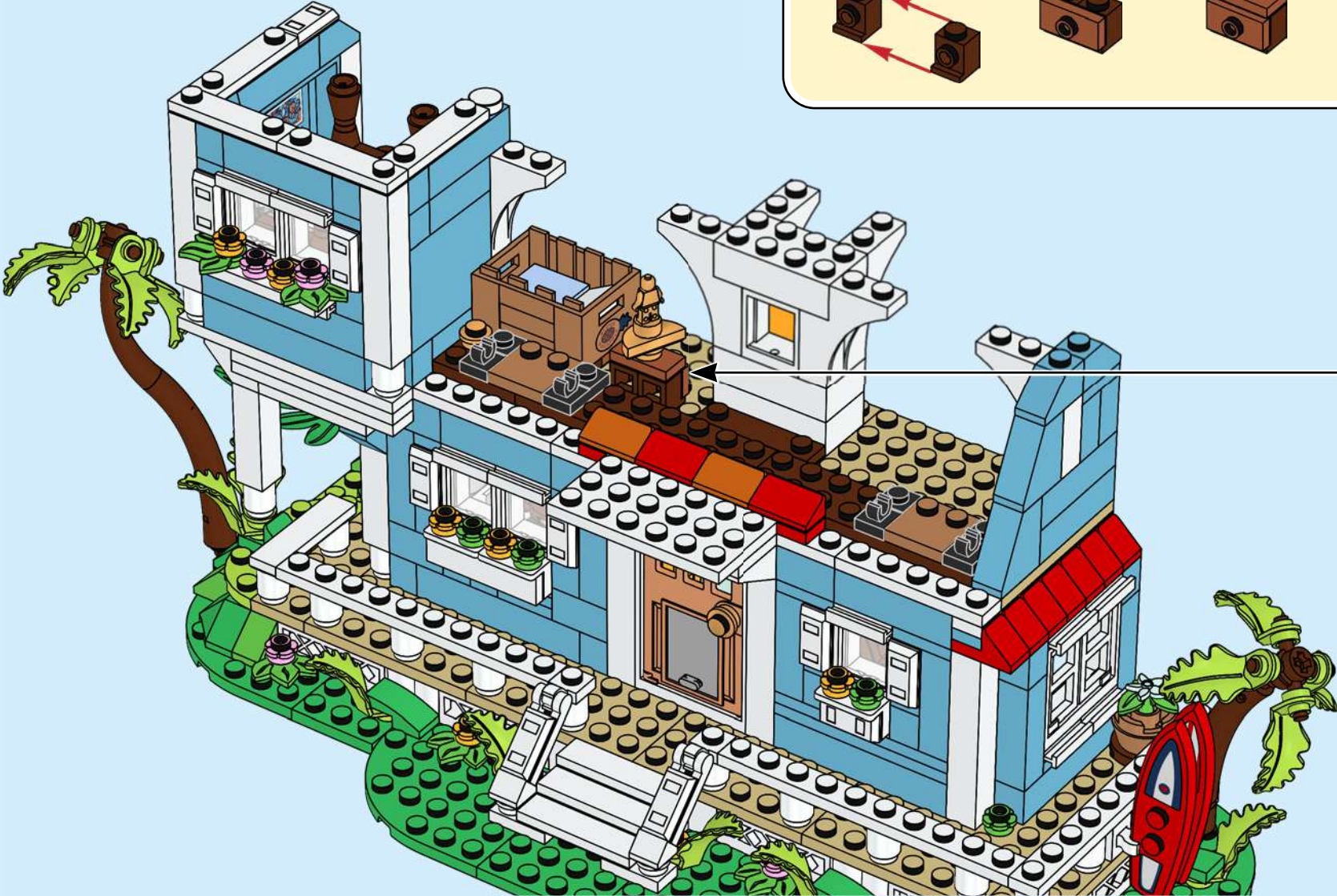
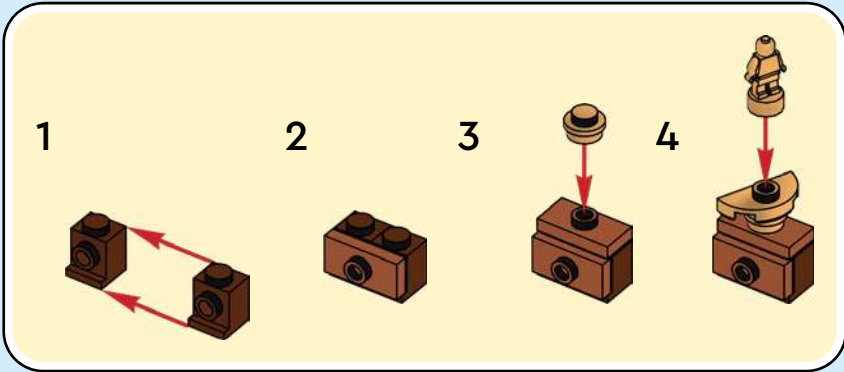

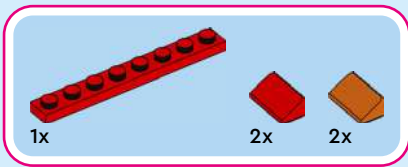

188

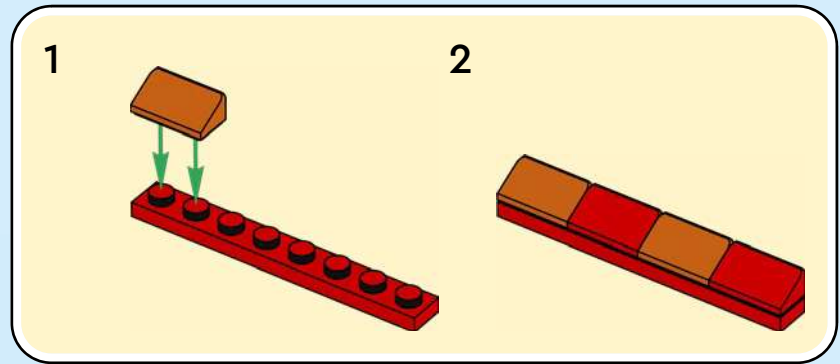

- 1x
- 2x
- 2x
- 1x
- 1x
- 1x

189

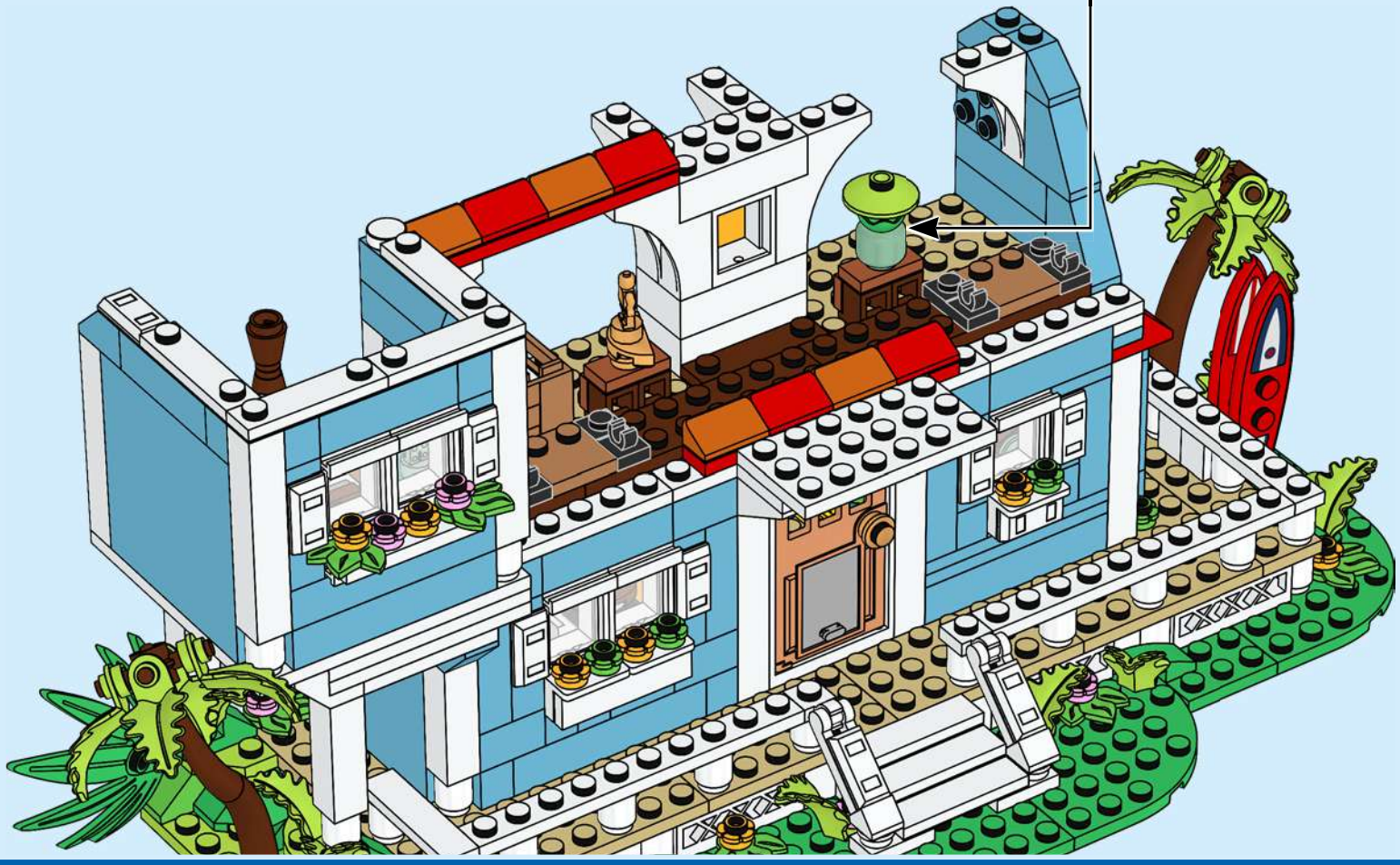
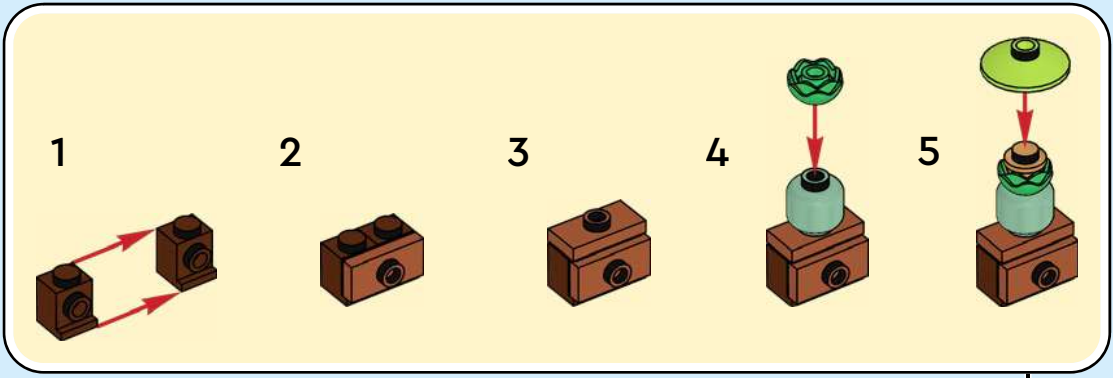

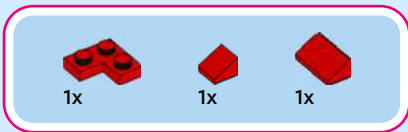

190

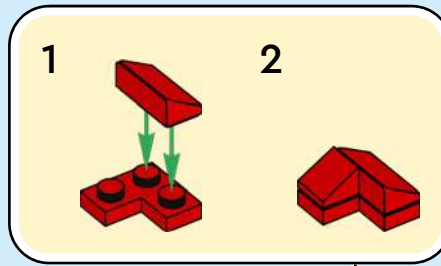

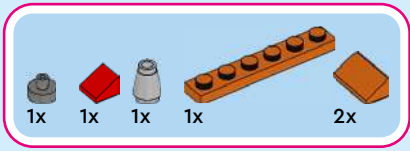

191

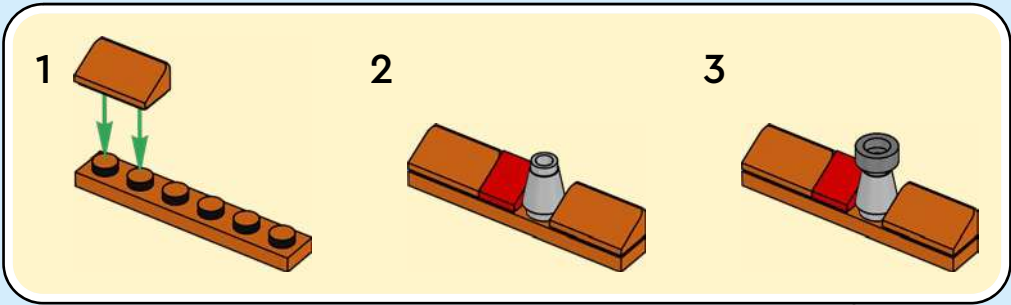

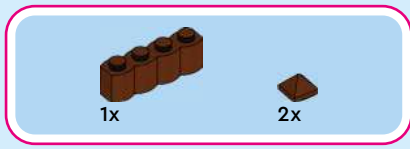

192

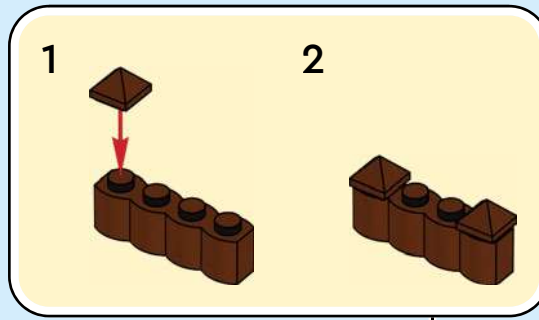

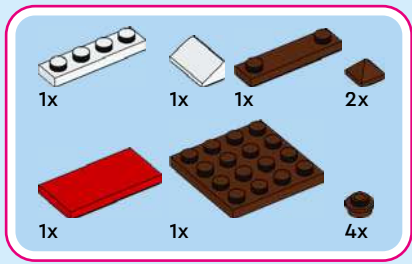

193

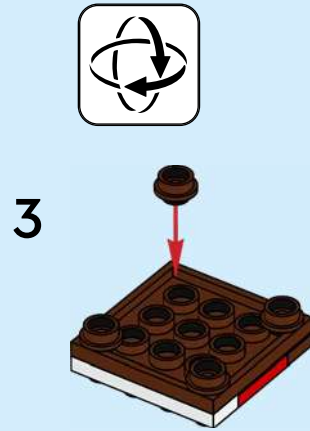
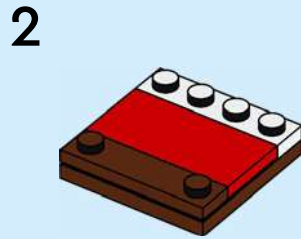
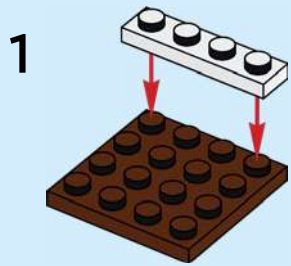



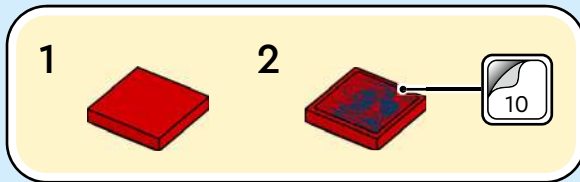

194





195



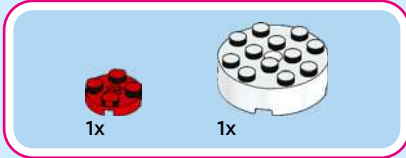

196



197



198

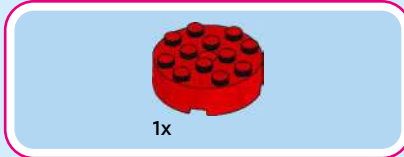
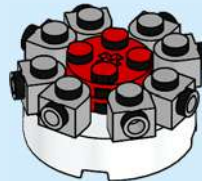

199

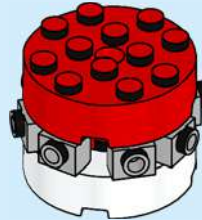

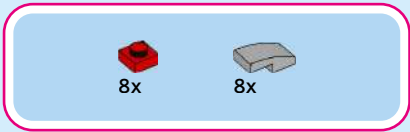

200

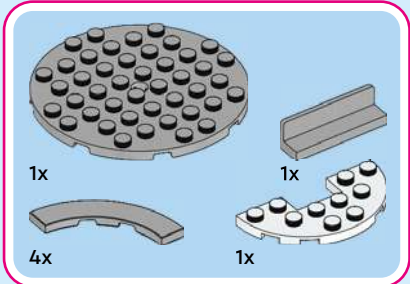
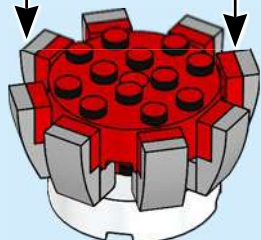
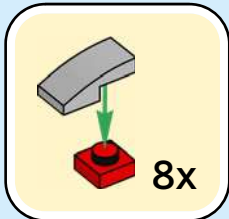

201

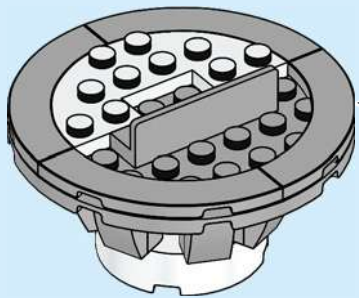
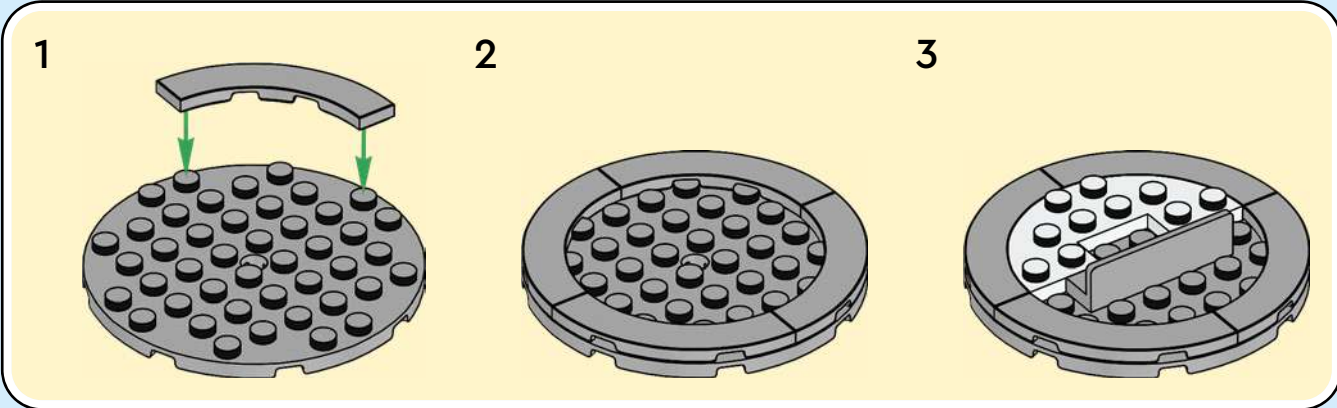

202



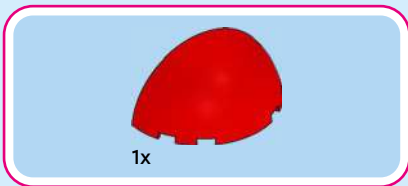

203





204

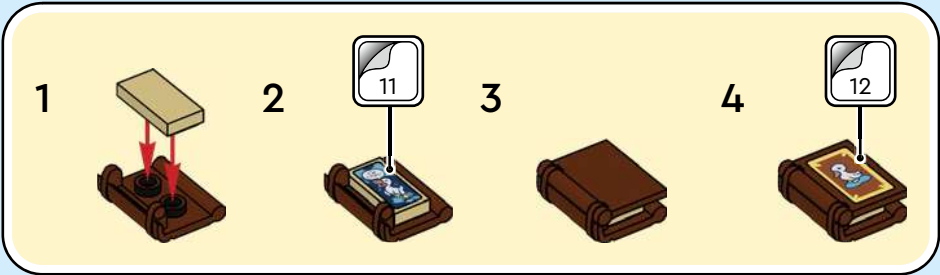



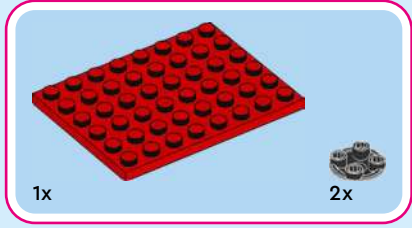
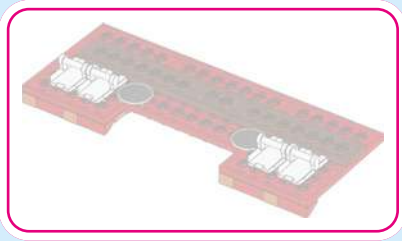

205

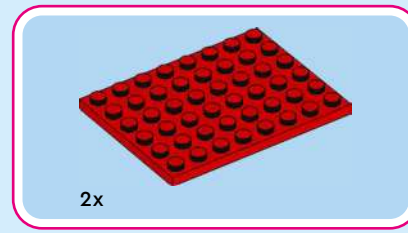
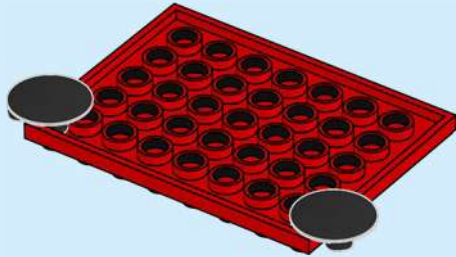

206

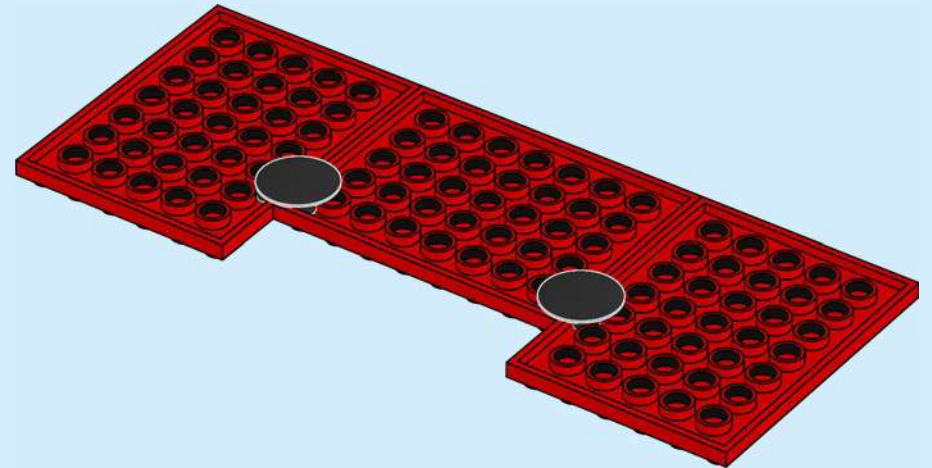

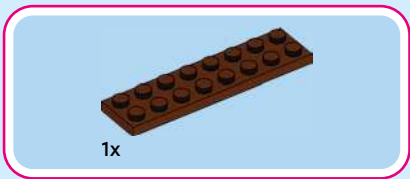

207

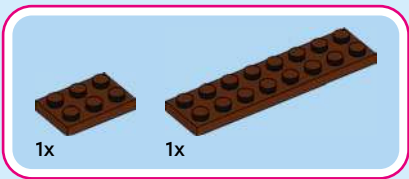
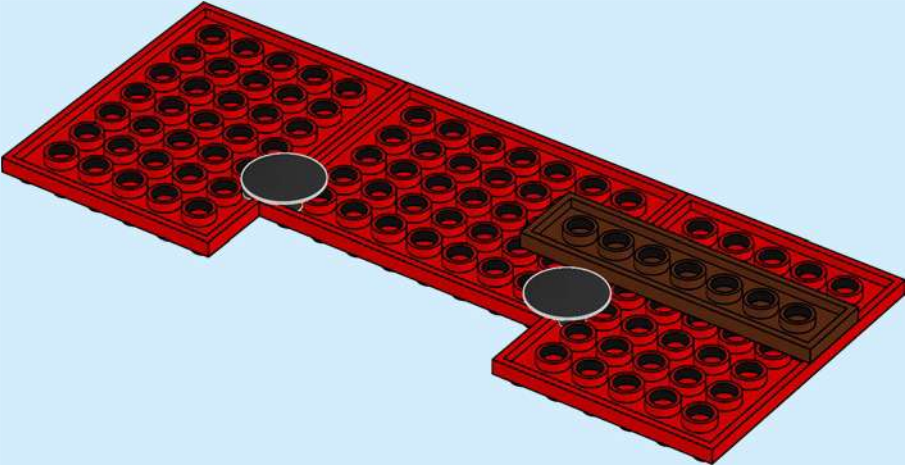

208

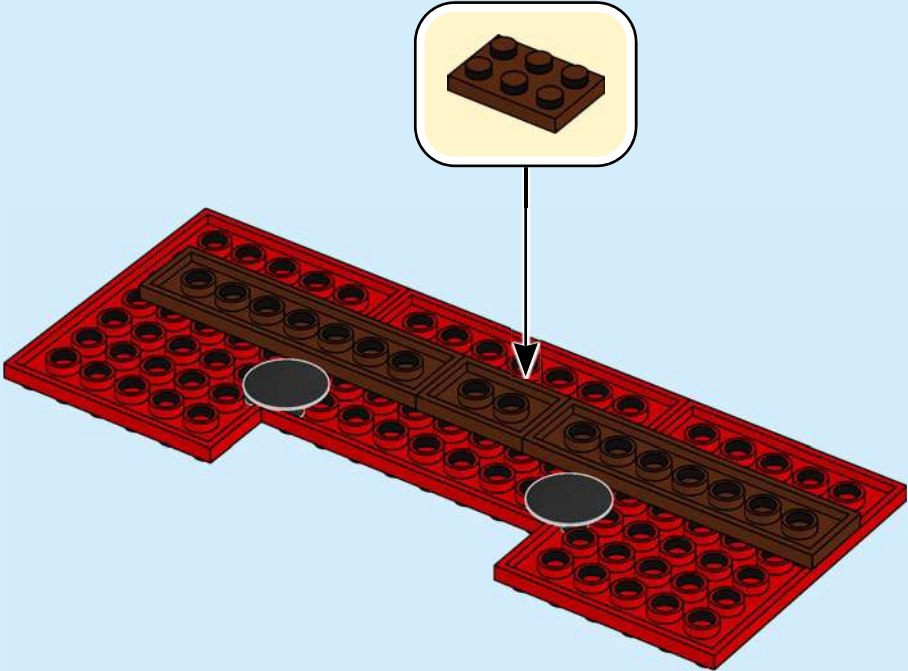

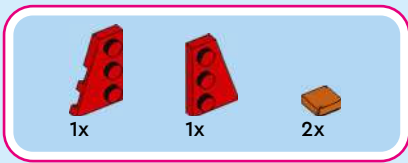

211

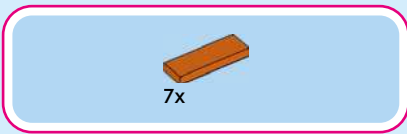
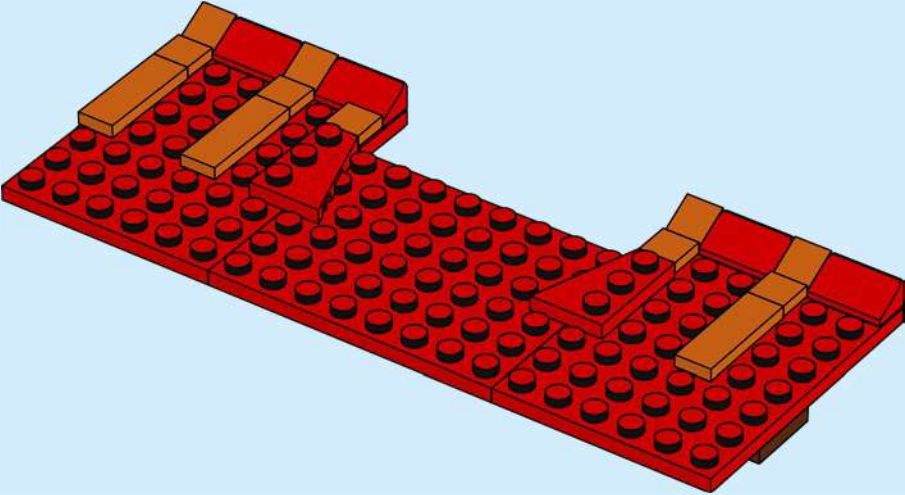

212

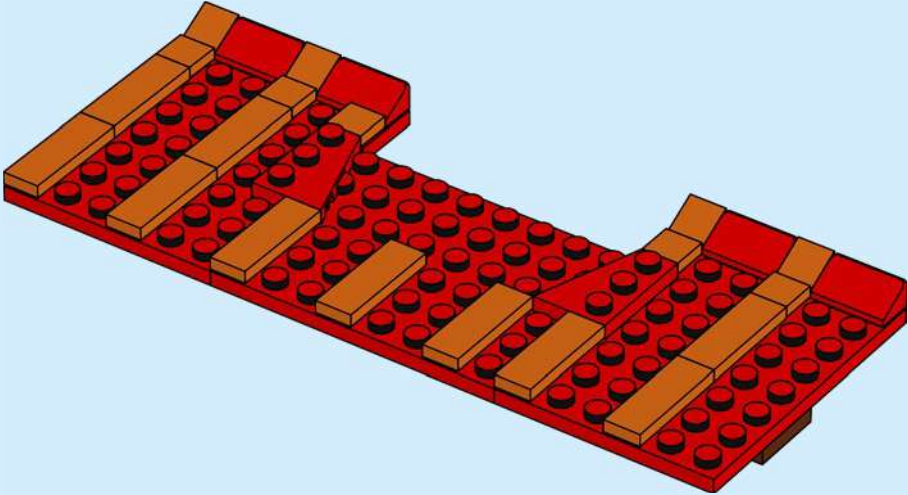



4x

213

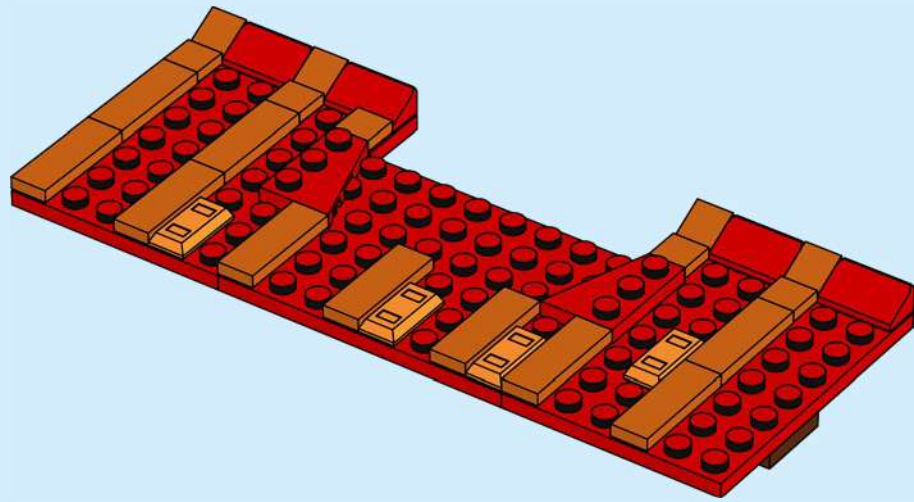

4x

214

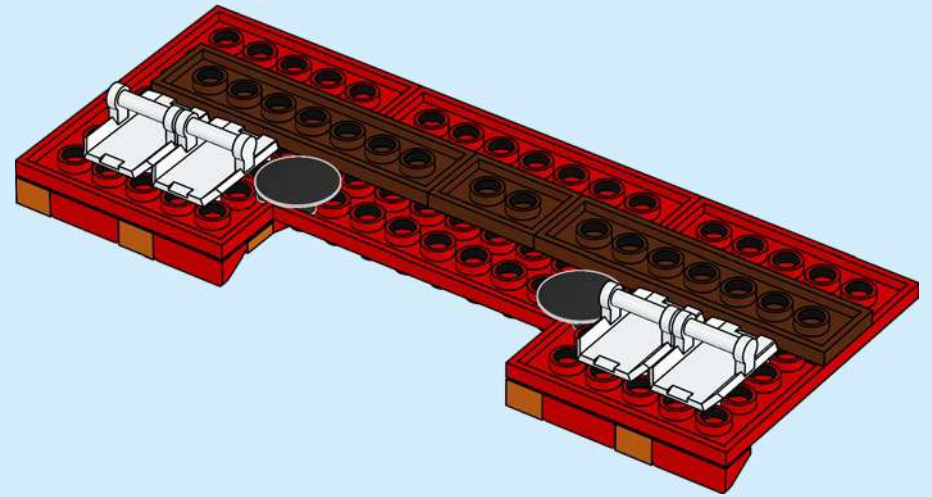

215

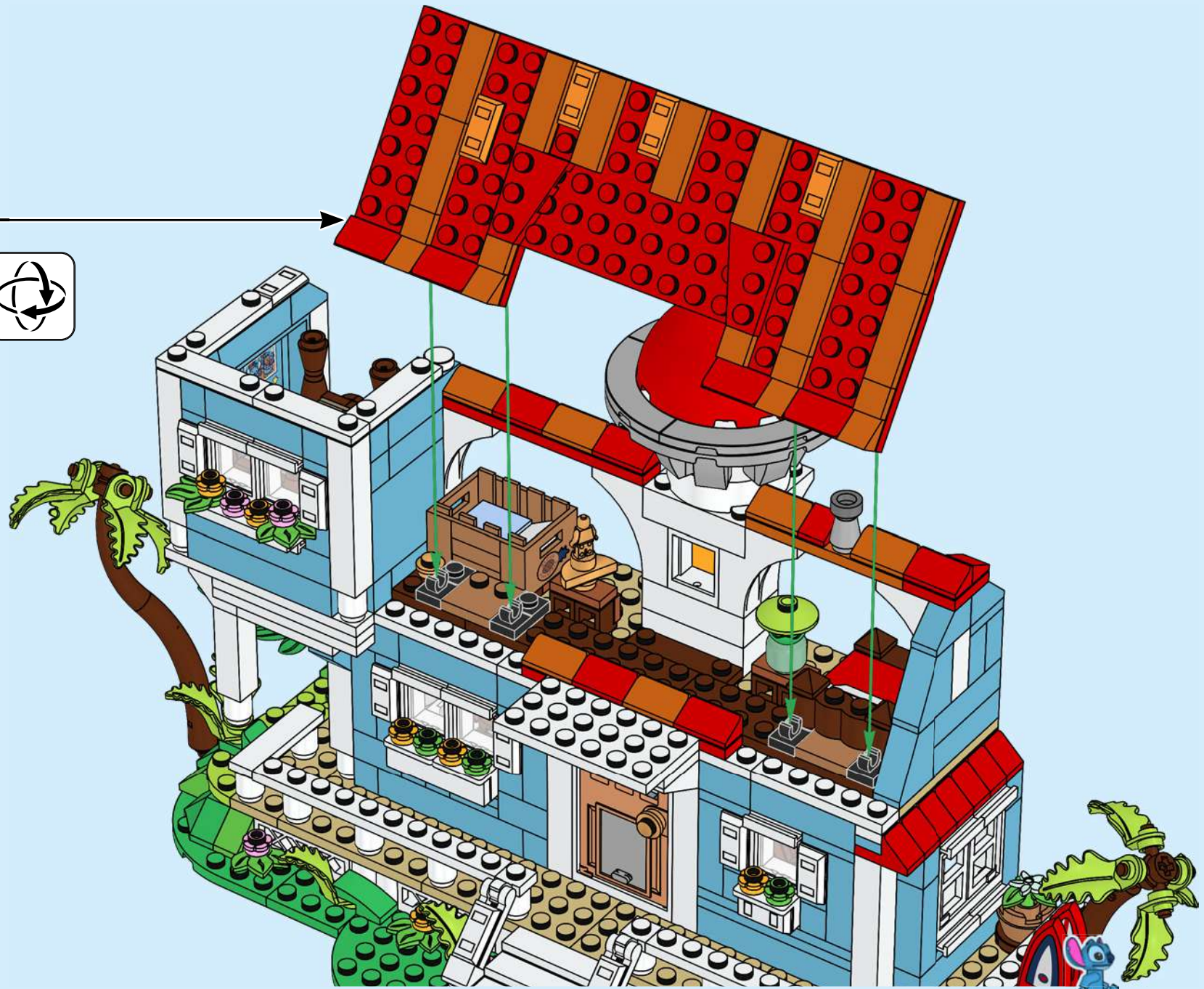



2x



2x

216

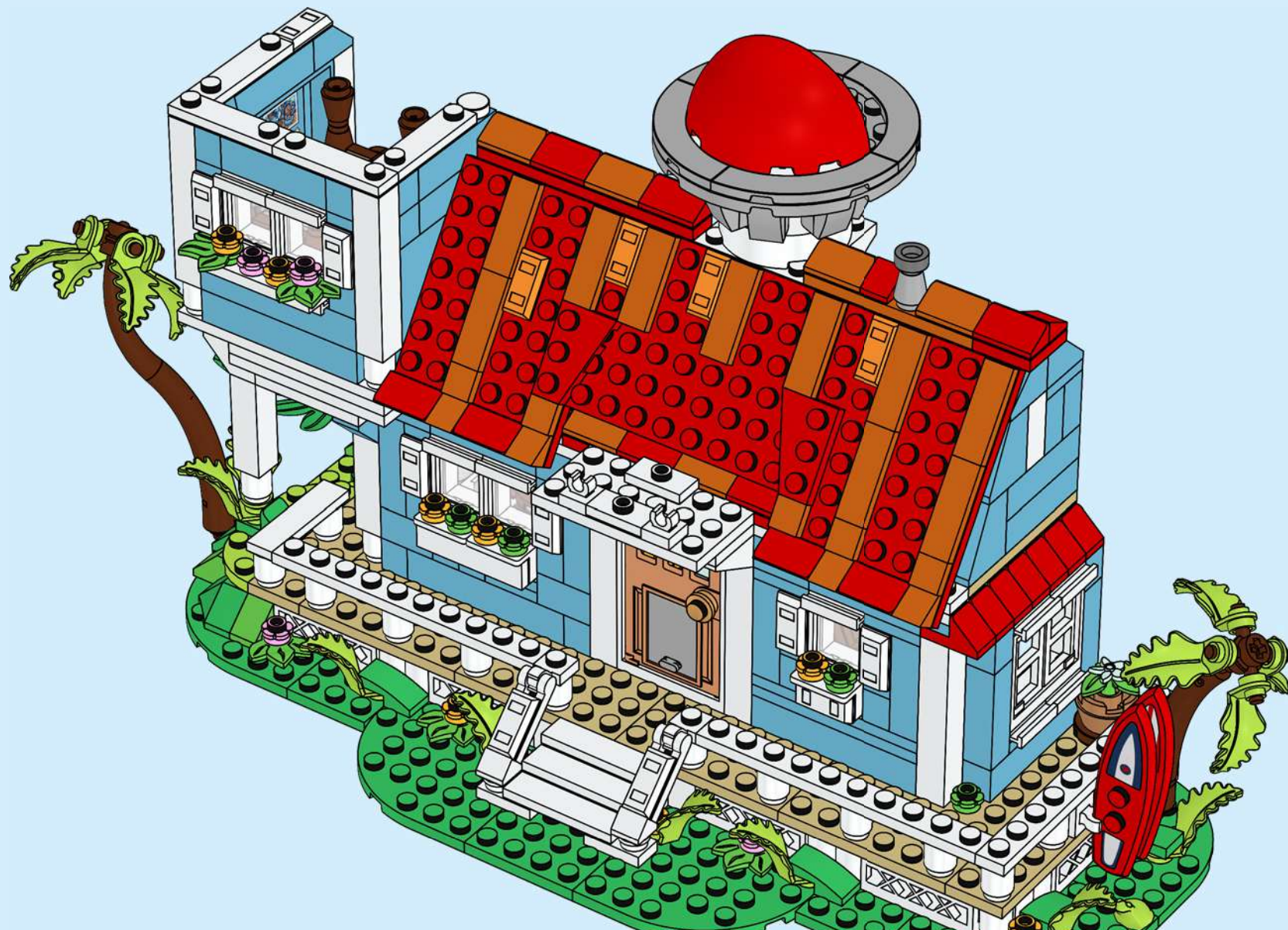

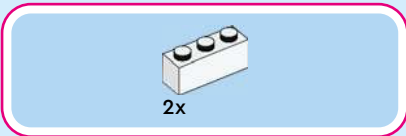

217

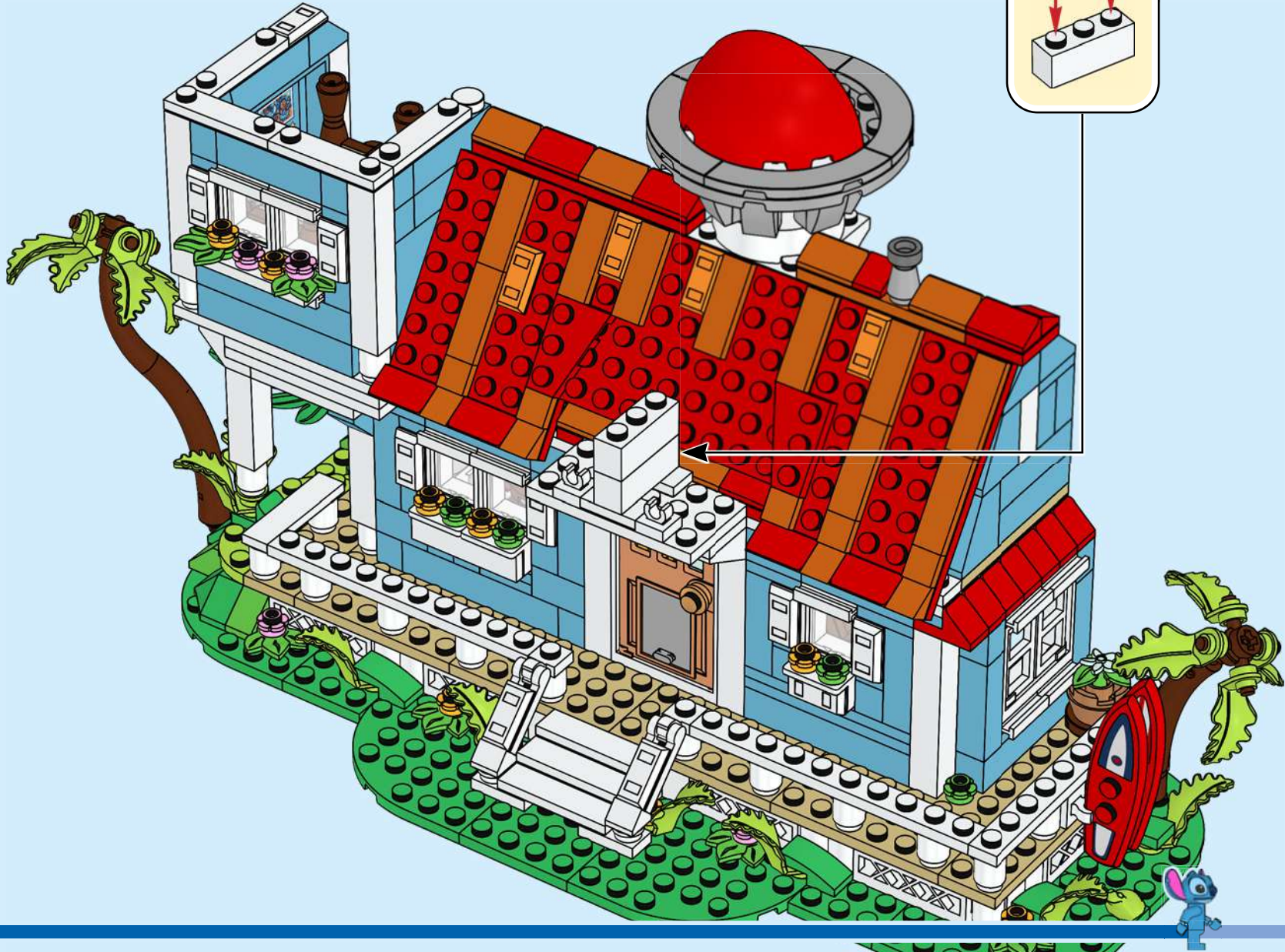
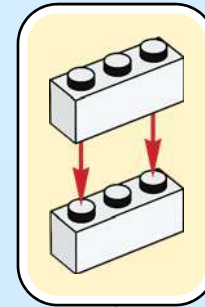

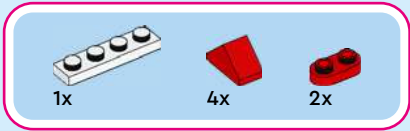

218

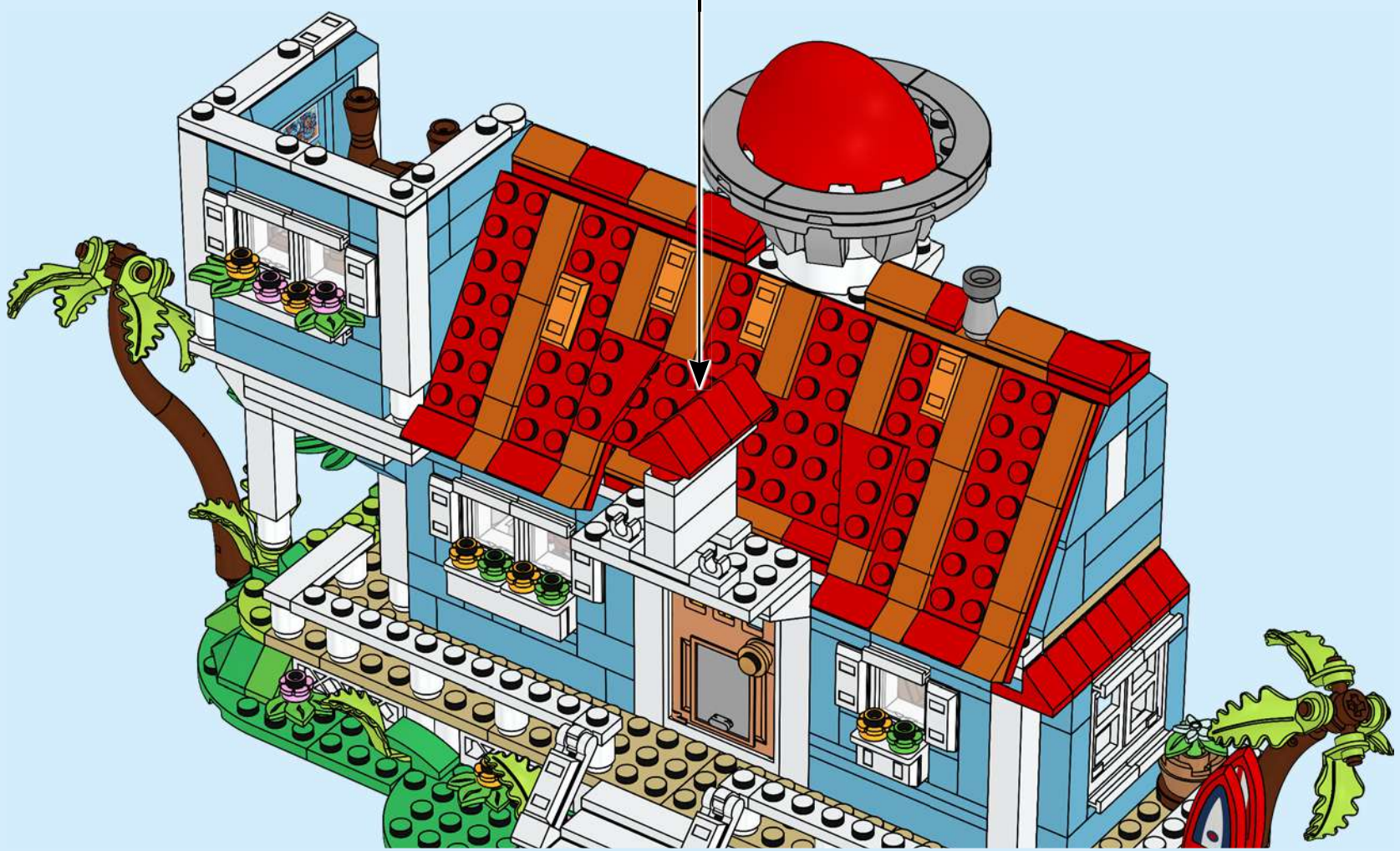
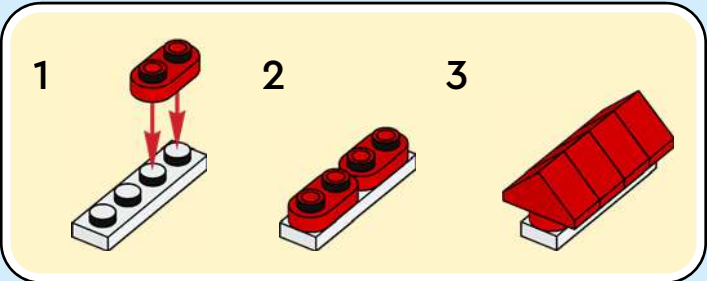

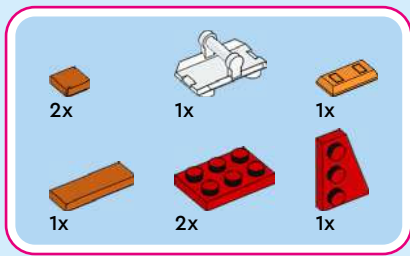

219

1



2



3



4



5

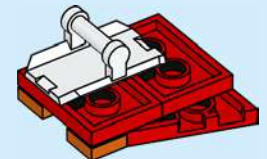

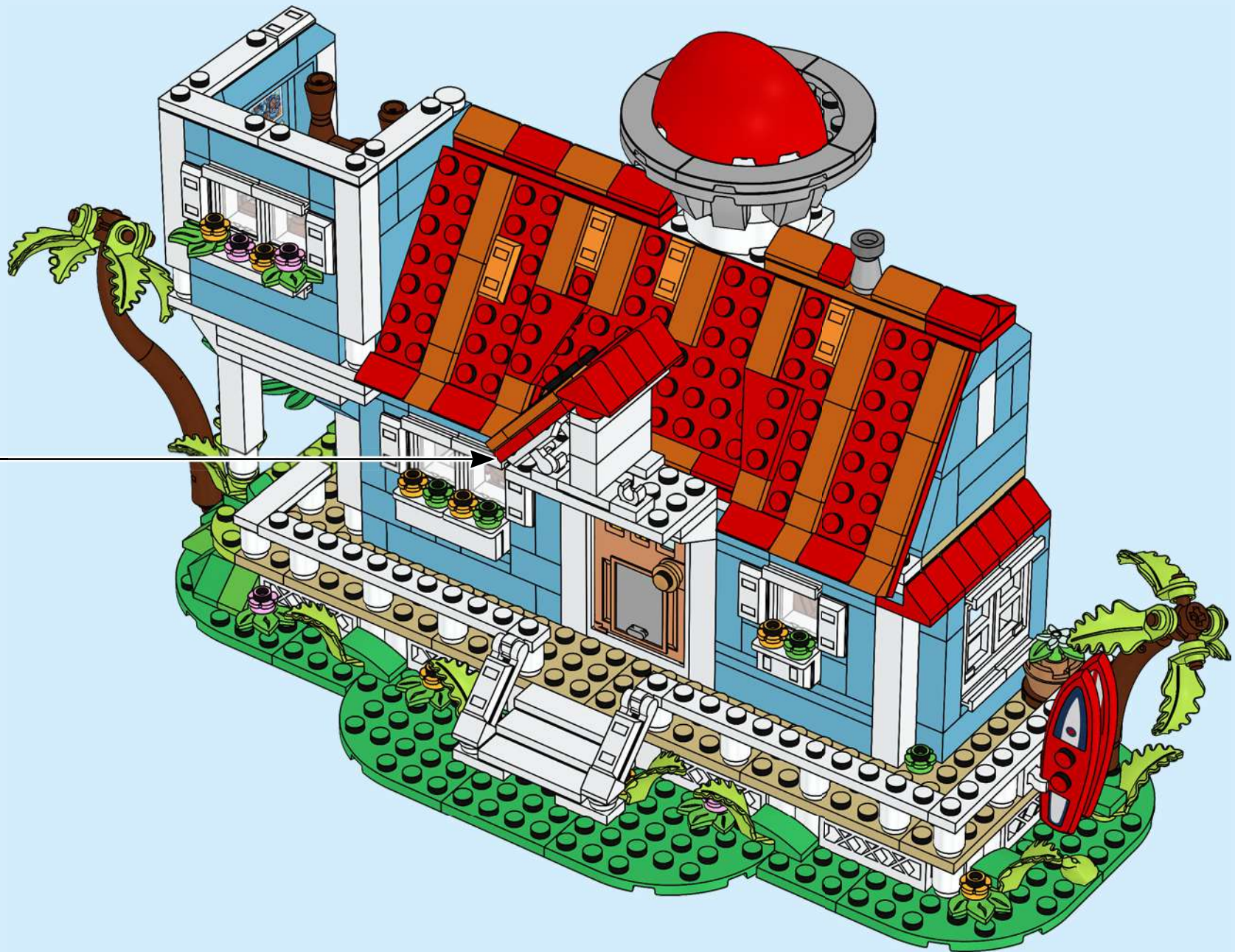

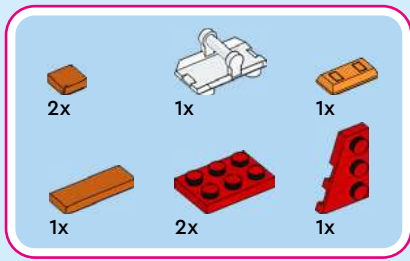

220

1



2



3



4



5

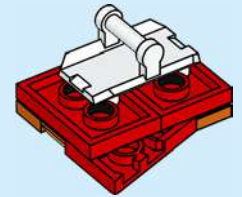
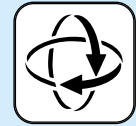

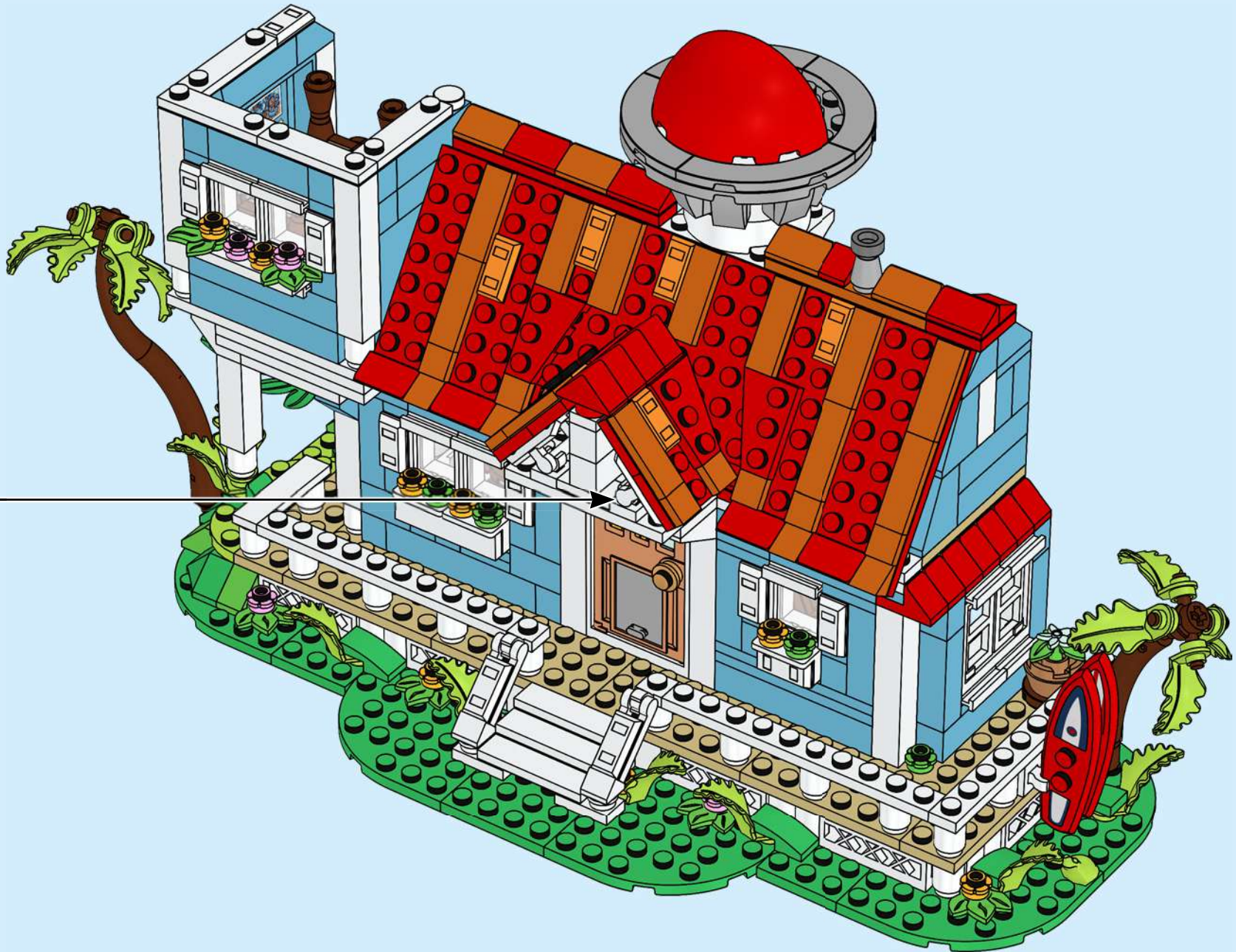

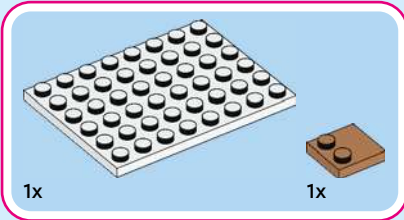

221

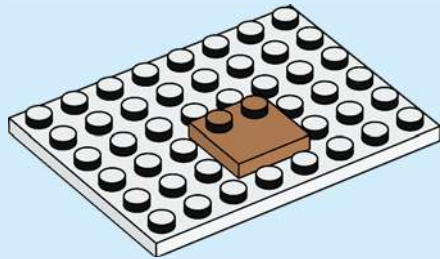

222

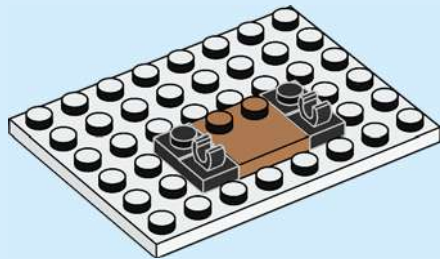

223

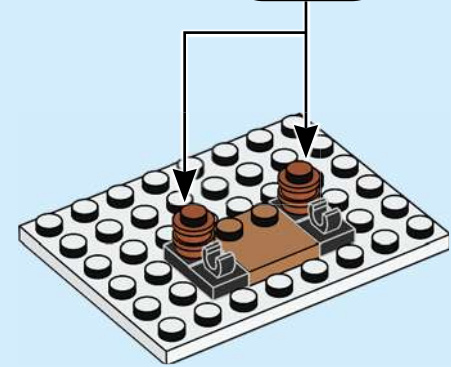
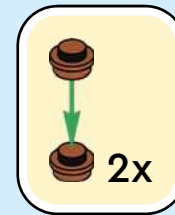

224

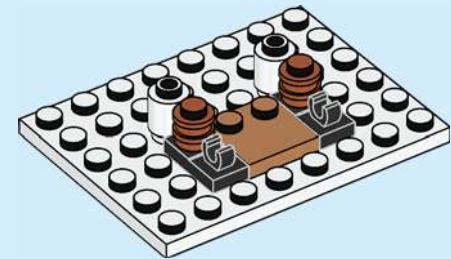

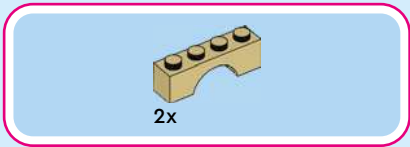

225

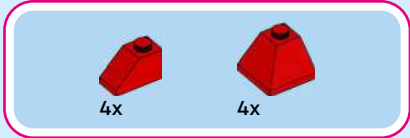
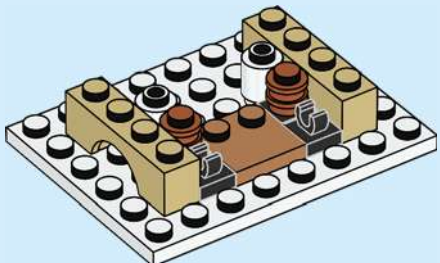

226

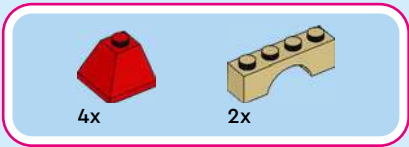
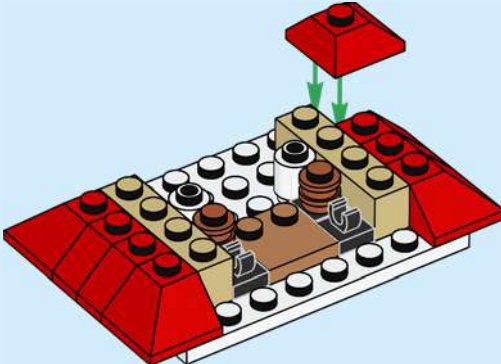

227

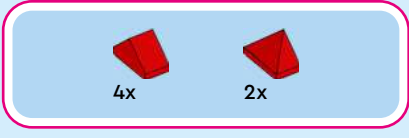
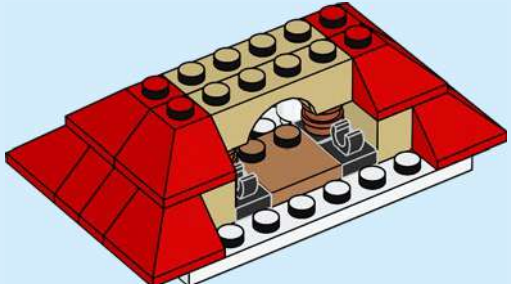

228

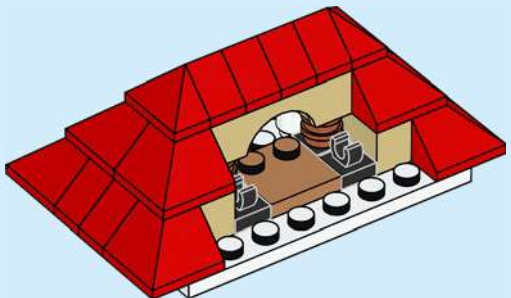

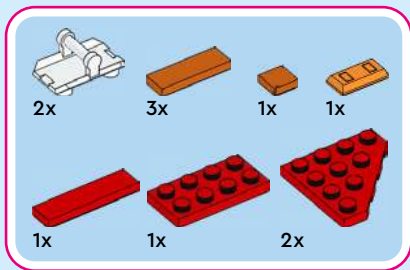

229

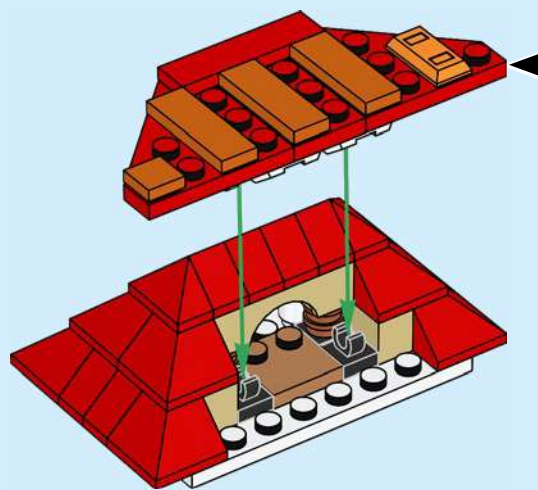
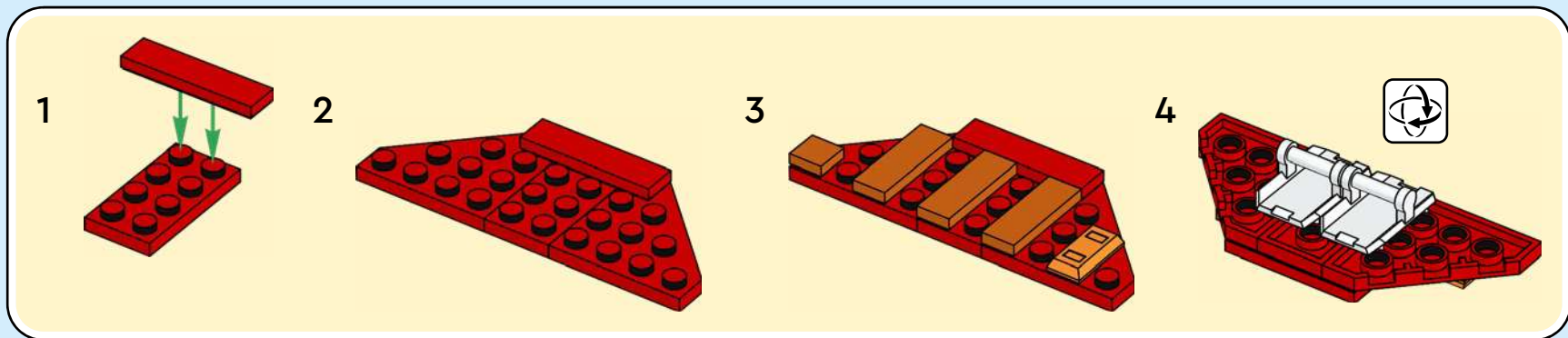

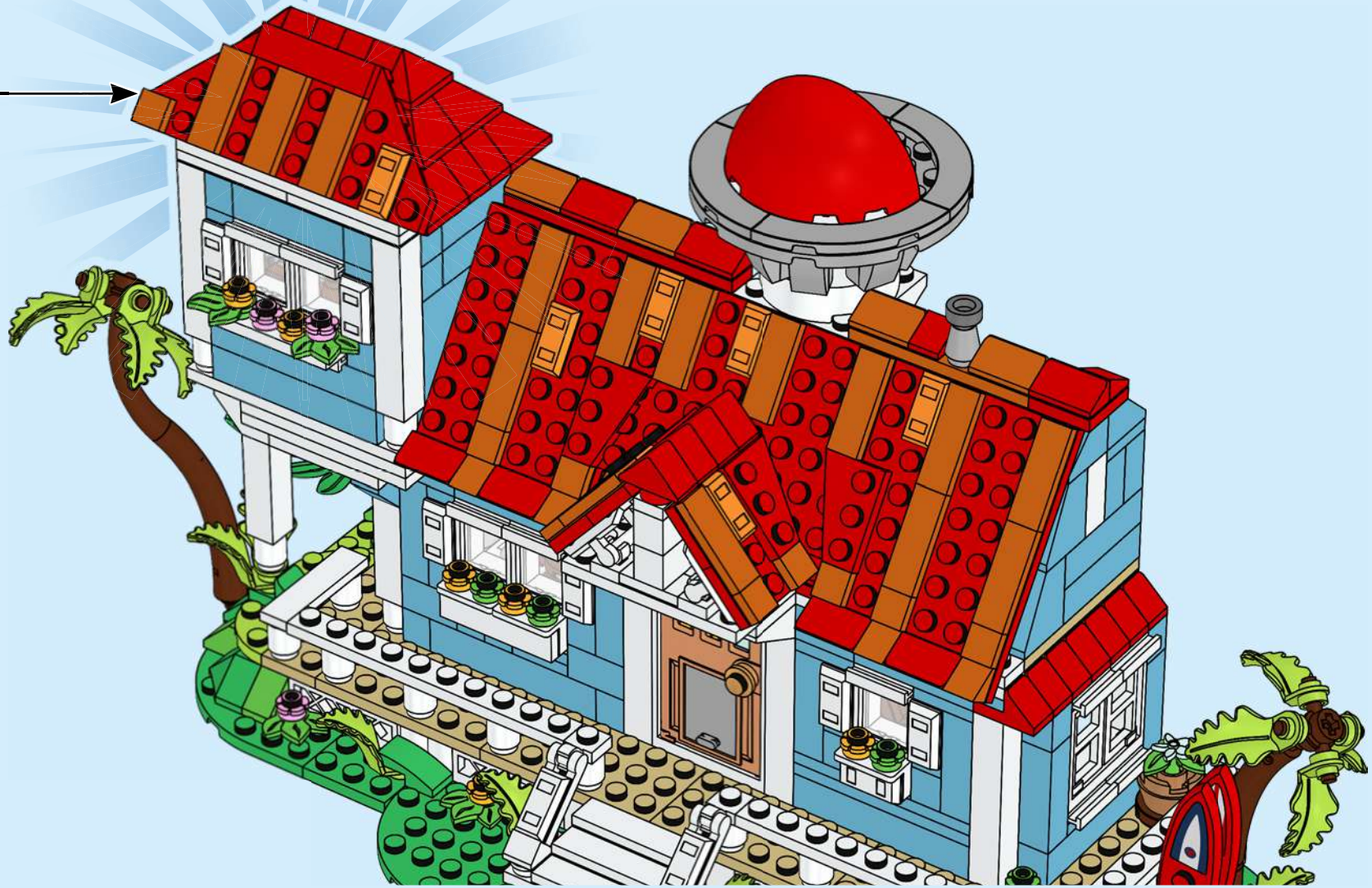





Disney





**Rebuild
the
World™**



- 22x 306201
- 3x 6284572
- 4x 614101
- 3x 6055541
- 2x 6286834
- 2x 6348055
- 8x 245301
- 2x 6171058
- 2x 6321349
- 2x 6347293
- 2x 434601
- 3x 4547489
- 1x 6310185
- 5x 6059185
- 6x 6382045
- 12x 6210076
- 1x 6248490
- 1x 6218823
- 2x 6051511
- 2x 6458097
- 3x 6070698
- 12x 4249563
- 4x 235701
- 2x 242001
- 6x 6218822
- 2x 4515364
- 6x 6038525
- 2x 428701
- 1x 362301
- 2x 362201
- 8x 6188400
- 1x 4530590
- 5x 4550171
- 1x 6034675
- 5x 371001
- 4x 6249091
- 5x 243101
- 1x 6262945
- 1x 4558956
- 2x 6428165
- 1x 302001
- 3x 300101
- 2x 6350399
- 1x 6192352
- 3x 366601
- 1x 4620761
- 1x 303201
- 1x 303401
- 3x 447701
- 1x 303601
- 4x 611201
- 1x 4624911
- 2x 6294552
- 1x 6324176
- 6x 6232135
- 2x 6024495
- 1x 6153157
- 1x 4114026
- 4x 4550323
- 3x 4114319
- 2x 4143409
- 1x 4509897
- 2x 4249019
- 2x 6070501
- 4x 4624185
- 1x 6533565
- 2x 6223427
- 2x 6337734
- 2x 4504379
- 10x 302421
- 3x 6348058
- 2x 6030266
- 2x 6210269
- 2x 4180504
- 2x 4180533
- 9x 4651524
- 2x 6075074
- 8x 4157124
- 2x 403221
- 1x 6524485
- 1x 6524491
- 2x 6275178
- 7x 6053011
- 4x 4121934
- 2x 4540382
- 2x 6394880
- 2x 6029946
- 8x 4163087
- 1x 306821
- 1x 242021
- 2x 4251162
- 1x 6517019
- 4x 302121
- 2x 6278445
- 1x 243121
- 2x 371021
- 1x 4610843
- 1x 6215396
- 1x 4560179
- 1x 302021
- 1x 6527060
- 2x 6525911
- 1x 346021
- 1x 303421
- 3x 303621
- 2x 6441826
- 1x 6526122
- 4x 241224
- 1x 6469455
- 1x 243124
- 1x 6514276
- 1x 6168646
- 1x 459926
- 1x 6529366
- 1x 6171772
- 2x 4278359
- 1x 6195325
- 1x 9339
- 6x 6347310
- 3x 302326
- 1x 6421735
- 1x 4565323
- 1x 6538521
- 1x 6515226
- 1x 6253140
- 4x 6226931
- 4x 6047426
- 3x 6297286
- 2x 6253139
- 1x 6313099
- 1x 4116671

| | | | | | | | | | | | |
|------------------------------------------------------------------------------------|-------------------------------------------------------------------------------------|-------------------------------------------------------------------------------------|-------------------------------------------------------------------------------------|-------------------------------------------------------------------------------------|-------------------------------------------------------------------------------------|---------------------------------------------------------------------------------------|---------------------------------------------------------------------------------------|---------------------------------------------------------------------------------------|---------------------------------------------------------------------------------------|---------------------------------------------------------------------------------------|-----------------------------------------------------------------------------------|
|  |  |  |  |  |  |  |  |  |  |  |  |
| 5x 6021999 | 9x 6359696 | 1x 6173012 | 5x 6028736 | 1x 6524492 | 2x 6533566 | 1x 4529241 | 3x 6070769 | 3x 6528998 | 1x 6532063 | 1x 6539642 | |
|  |  |  |  |  |  |  |  |  |  |  | |
| 4x 6206150 | 1x 6240030 | | 3x 6523916 | 4x 4225469 | 2x 4216695 | 8x 6448793 | 5x 6097419 | 1x 6538522 | 1x 6503439 | 1x 6258095 | |
|  |  |  |  |  |  |  |  |  |  |  | |
| 1x 6235080 | 1x 6524494 | 1x 4525858 | 1x 4622062 | 8x 6149677 | 1x 4271949 | 2x 6227897 | 2x 6092674 | 1x 6160320 | 1x 6524486 | 1x 6258570 | |
|  |  |  |  |  |  |  |  |  |  |  | |
| 7x 6182261 | 1x 6254552 | 1x 6435720 | 1x 6020147 | 1x 6167879 | 1x 4211257 | 4x 6296894 | 3x 4619655 | 1x 6160320 | 1x 6440647 | 10x 6475042 | |
|  |  |  |  |  |  |  |  |  |  |  | |
| 1x 6343326 | 5x 6254552 | 17x 6438450 | 1x 6020147 | 1x 6167879 | 2x 4216668 | 1x 6429052 | 2x 6210399 | 1x 6035734 | 1x 6212501 | 4x 6473212 | |
|  |  |  |  |  |  |  |  |  |  |  | |
| 4x 6300148 | 1x 6271752 | 2x 6093064 | 2x 6073042 | 1x 6174229 | 2x 4216668 | 1x 6429052 | 4x 6213777 | 1x 6035734 | 1x 4624615 | 6x 6483784 | |
|  |  |  |  |  |  |  |  |  |  |  | |
| 1x 6401818 | 2x 6395635 | 1x 6194290 | 3x 6061688 | 1x 6037289 | 3x 4211189 | 1x 6261353 | 5x 6290269 | 1x 6451017 | 1x 4523159 | 15x 6483781 | |
|  |  |  |  |  |  |  |  |  |  |  | |
| 1x 6401818 | 1x 6194290 | 2x 6330148 | 3x 6061688 | 1x 6037289 | 1x 4211181 | 8x 6028813 | 1x 6254100 | 2x 6356108 | 1x 6503258 | 1x 6469087 | |
|  |  |  |  |  |  |  |  |  |  |  | |
| 3x 6357612 | 1x 6194290 | 1x 6047415 | 1x 6097503 | 1x 6092568 | 6x 6257604 | 1x 6132390 | 1x 6254100 | 1x 6070757 | 1x 6524484 | 1x 6524488 | |
|  |  |  |  |  |  |  |  |  |  |  | |
| 1x 6294513 | 2x 6230233 | 1x 6047415 | 1x 6335936 | 1x 6102360 | 1x 4211194 | 1x 4211387 | 2x 6445319 | 9x 6036238 | 1x 6539846 | 1x 6524495 | |
|  |  |  |  |  |  |  |  |  |  |  | |
| 4x 6315782 | 1x 6396395 | 1x 6454728 | 1x 6335936 | 2x 6261359 | 4x 4538252 | 1x 4211397 | 2x 6445319 | 6x 6149781 | 1x 6524505 | 1x 6230582 | |
|  |  |  |  |  |  |  |  |  |  |  | |
| 5x 6092602 | 1x 6396395 | 1x 6454728 | 1x 6335936 | 2x 6261359 | 4x 4538252 | 1x 4211387 | 2x 6445319 | 6x 6149781 | 1x 6524505 | 1x 6230582 | |
|  |  |  |  |  |  |  |  |  |  |  | |
| 1x 6315197 | 1x 6121816 | 2x 6357616 | 1x 6454728 | 4x 6313124 | 2x 4211186 | 1x 4211397 | 2x 6445319 | 11x 4619652 | 1x 6524505 | 1x 6162894 | |
|  |  |  |  |  |  |  |  |  |  |  | |
| 3x 6074893 | 1x 6121816 | 2x 6357616 | 1x 6454728 | 4x 6313124 | 2x 4211186 | 1x 4211397 | 2x 6445319 | 11x 4619652 | 1x 6524505 | 1x 6162894 | |
|  |  |  |  |  |  |  |  |  |  |  | |
| 1x 6315197 | 1x 6121816 | 2x 6357616 | 1x 6454728 | 4x 6313124 | 2x 4211186 | 1x 4211397 | 2x 6445319 | 11x 4619652 | 1x 6524505 | 1x 6162894 | |
|  |  |  |  |  |  |  |  |  |  |  | |
| 3x 6074893 | 1x 6121816 | 2x 6357616 | 1x 6454728 | 4x 6313124 | 2x 4211186 | 1x 4211397 | 2x 6445319 | 11x 4619652 | 1x 6524505 | 1x 6162894 | |
|  |  |  |  |  |  |  |  |  |  |  | |
| 1x 6315197 | 1x 6121816 | 2x 6357616 | 1x 6454728 | 4x 6313124 | 2x 4211186 | 1x 4211397 | 2x 6445319 | 11x 4619652 | 1x 6524505 | 1x 6162894 | |
|  |  |  |  |  |  |  |  |  |  |  | |
| 3x 6074893 | 1x 6121816 | 2x 6357616 | 1x 6454728 | 4x 6313124 | 2x 4211186 | 1x 4211397 | 2x 6445319 | 11x 4619652 | 1x 6524505 | 1x 6162894 | |
|  |  |  |  |  |  |  |  |  |  |  | |
| 1x 6315197 | 1x 6121816 | 2x 6357616 | 1x 6454728 | 4x 6313124 | 2x 4211186 | 1x 4211397 | 2x 6445319 | 11x 4619652 | 1x 6524505 | 1x 6162894 | |
|  |  |  |  |  |  | | | | | | |

YOU COULD WIN



Scan this QR code or go to
LEGO.COM/PRODUCTFEEDBACK and give us
your short feedback about this LEGO® set
for a chance to win a cool LEGO prize.

Terms and Conditions apply*



EN: YOU COULD WIN. Terms and Conditions apply* **DE: Du könntest GEWINNEN.** Es gelten die Teilnahmebedingungen* **FR: Tu pourrais GAGNER.** Des conditions s'appliquent* **IT: Potresti VINCERE tu.** Termini e condizioni sono applicabili* **ES: Puedes GANAR.** Aplican términos y condiciones* **PT: PODERÁ GANHAR.** Aplicam-se Termos e Condições* **ZH: 轻松获奖.** 条款和条件适用* **PL: Szansa na WYGRANĄ.** Obowiązuje regulamin* **CS: Máte šanci VYHRÁT.** Platí všeobecné smluvní podmínky* **SK: Máte šancu VYHRÁT.** Platia všeobecné zmluvné podmienky* **HU: TE IS NYERHETSZ.** Felhasználási feltételek érvényesek* **UA: ВИ МОЖЕТЕ ВИГРАТИ.** Застосовуються загальні положення та умови* **RO: Ai putea CÂȘTIGA.** Se aplică termenii și condiții* **BG: Можете да СПЕЧЕЛИТЕ.** Има определени правила и условия* **LV: Tu vari LAIMĒT.** Ir spēkā noteikumi un nosacījumi.* **ET: Sul on võimalus VÕITA.** Kehtivad tingimused* **LT: Jūs galite LAIMĖTI.** Taikomos sąlygos*

*[LEGO.com/productfeedback-terms](https://www.lego.com/productfeedback-terms)