

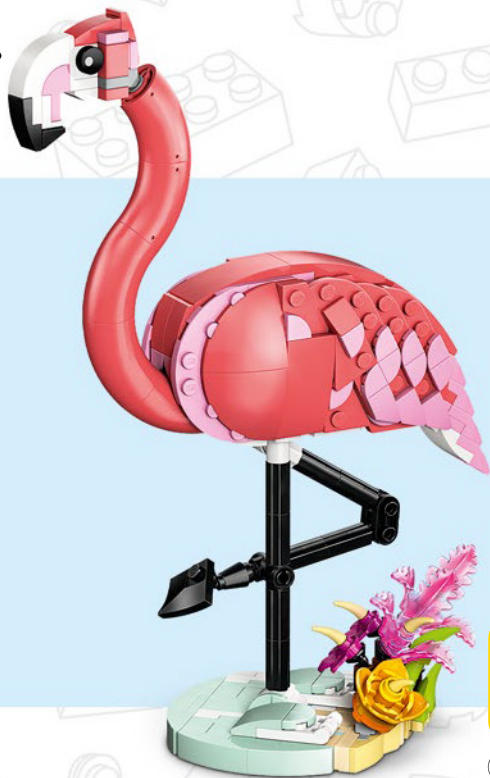

CREATOR™



31170



3in1	3 in 1	3 合 1	3 az 1-ben	3 ühes
3-in-1	3en1	3 w 1	3 in 1	„Trys viename“
3-en-1	3em1	3 v 1	„3 в 1“	



LEGO® Builder



LEGO.com/sustainable-packaging



 ^{FR} **DONNEZ**
OU
RECYCLEZ

 OU  OU 

ASSOCIATION MAGASIN DÉCHÈTERIE

Adresses sur quefairedemesdechets.fr



BUILDER



Apple and the Apple logo are trademarks of Apple Inc., registered in the U.S. and other countries and regions. App Store is a service mark of Apple Inc. Google Play and the Google Play logo are trademarks of Google LLC. Tencent and the Tencent logo are trademarks of Tencent Inc.

Q [LEGO.com/devicecheck](https://www.lego.com/devicecheck)

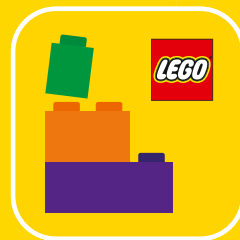

Q LEGO® Builder

EN Ask parents' permission before going online | DE Eltern um Erlaubnis bitten, bevor du online gehst | FR Demande l'autorisation d'un parent avant d'aller en ligne | IT Chiedi il permesso ai tuoi genitori prima di andare online | ES Pídeles permiso a tus papás antes de conectarte a Internet | PT Pede autorização aos pais antes de acederes online | ZH 上网前应先征得父母的同意 | PL Poproś rodziców o zgodę, zanim wejdiesz do Internetu | CS Než půjdeš na internet, požádej rodiče o svolení | SK Skôr než pôjdeš na internet, vypýtaj si povolenie od rodičov | HU Kérj szülői engedélyt, mielőtt online csatlakoznál! | RO Cere permisiunea părinților înainte de a te conecta online | BG Поискайте разрешение от родител, преди да влезете онлайн | LV Pirms došanās tiešsaistē palūdz atļauju vecākiem | ET Enne Interneti kasutamist küsi vanematelt luba | LT Prieš prisijungdami prie interneto, atsiklauskite tėvų

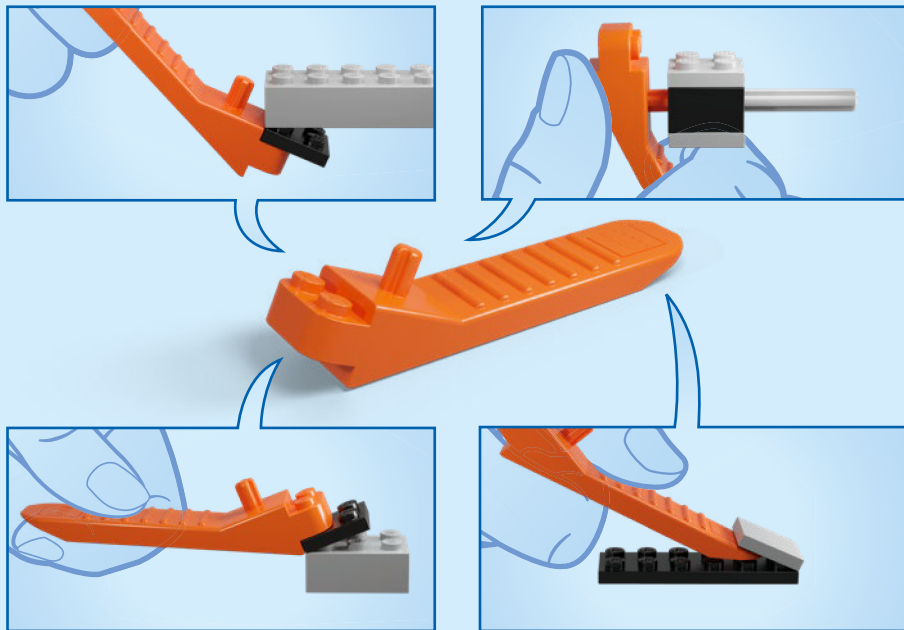



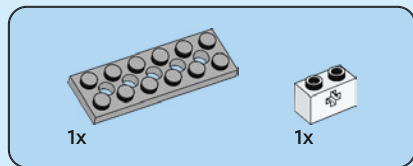

1

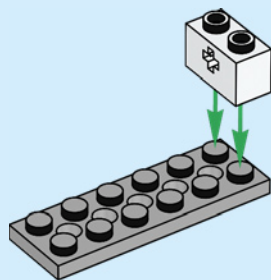



2

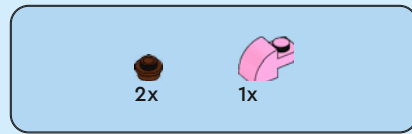
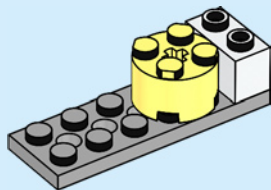

3

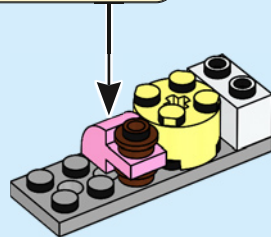
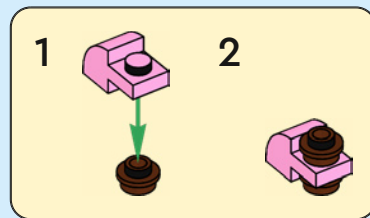

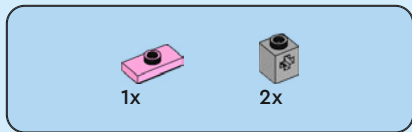

4

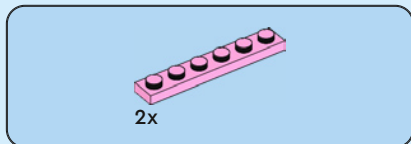
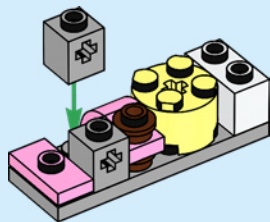

5

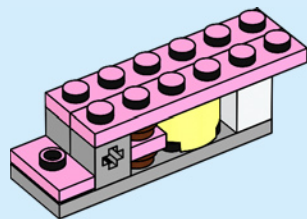



1x

6

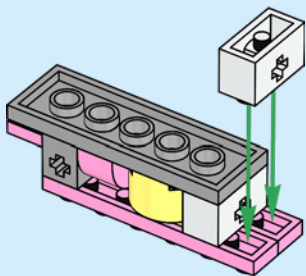

1x



1x

7

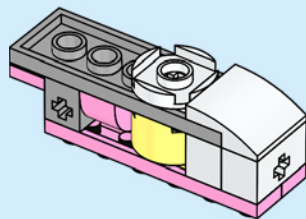

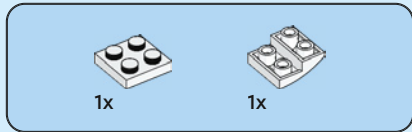

8

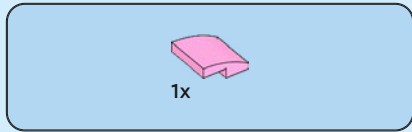
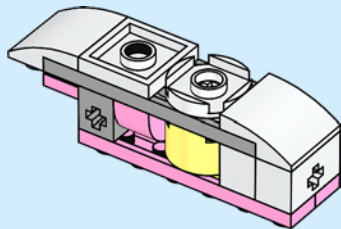

9

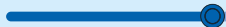
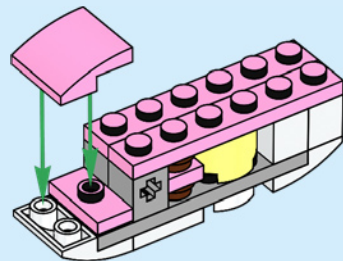

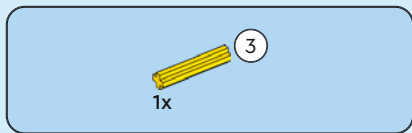

10

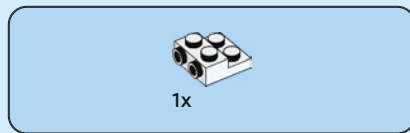
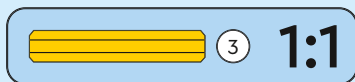
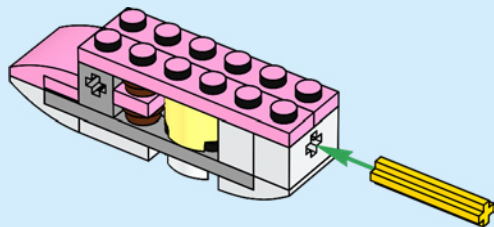

11

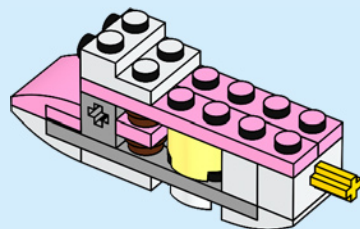



2x

12

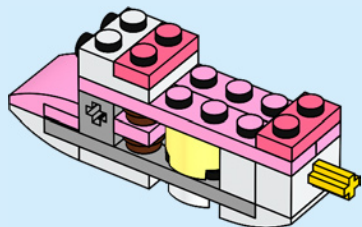

1x



1x

13

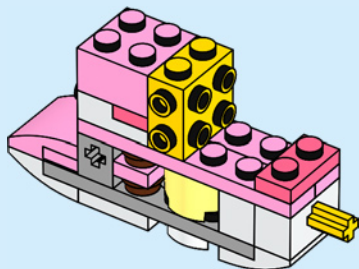

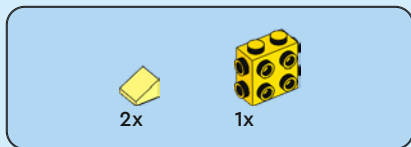

14

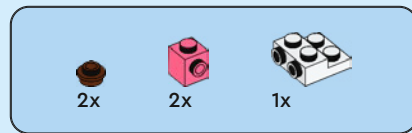
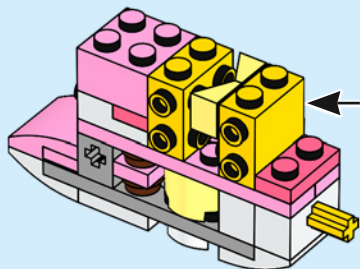
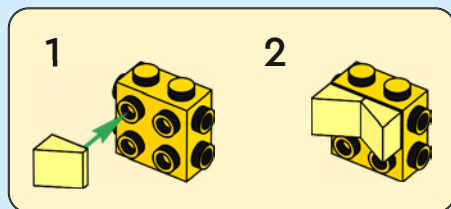

15

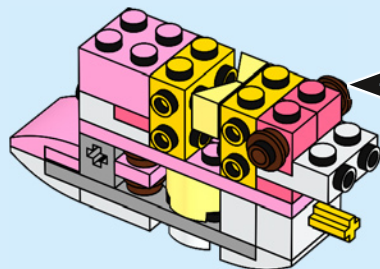
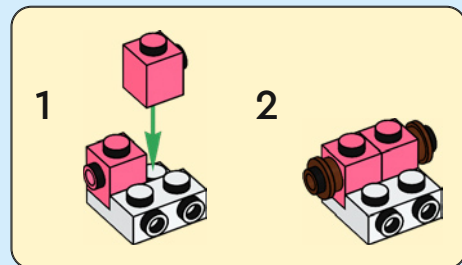

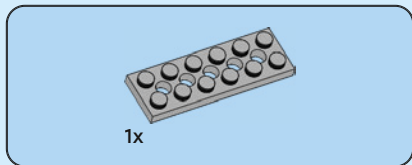

16

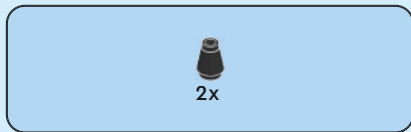
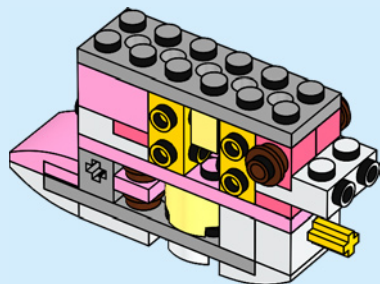

17

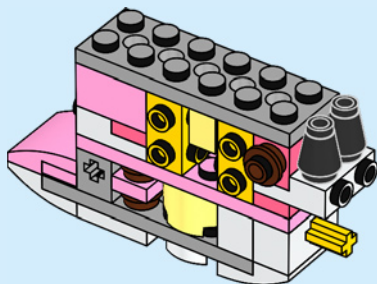

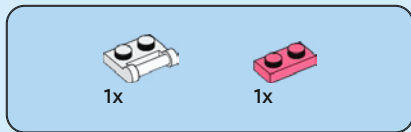

18

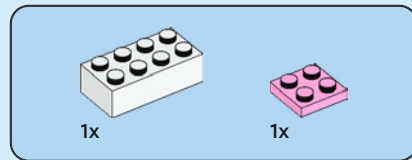
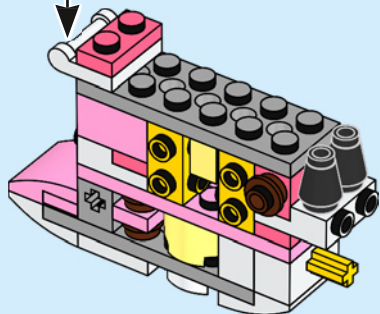
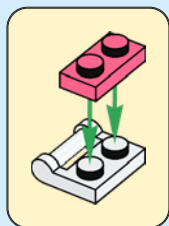

19

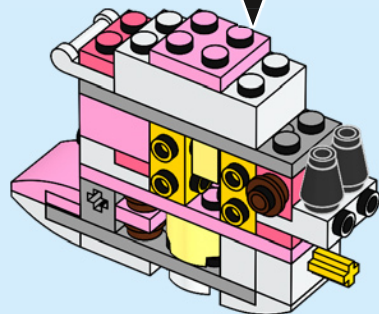
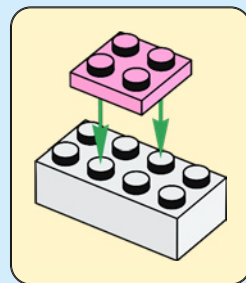



1x



1x

20

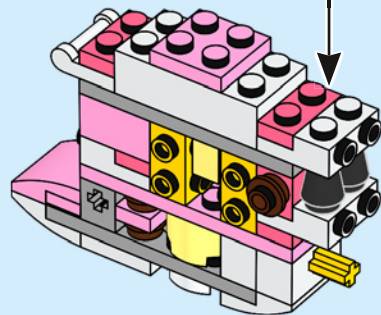
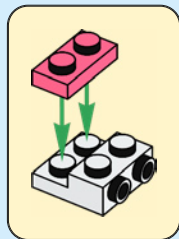

2x

21

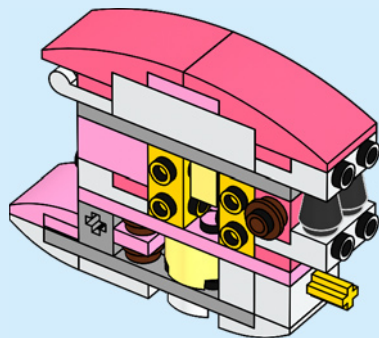

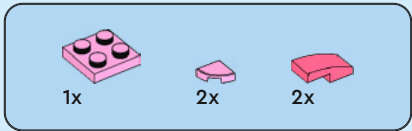

22

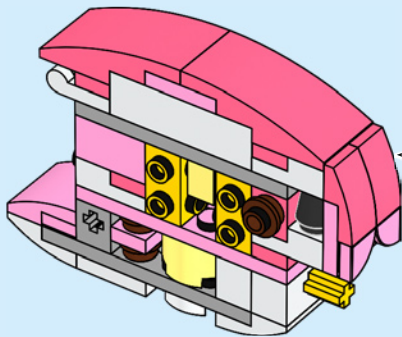
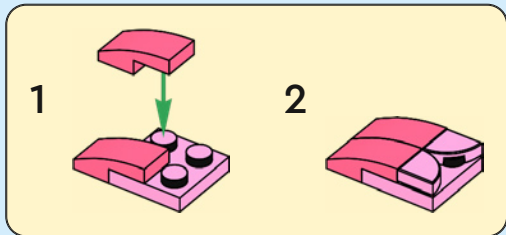

23

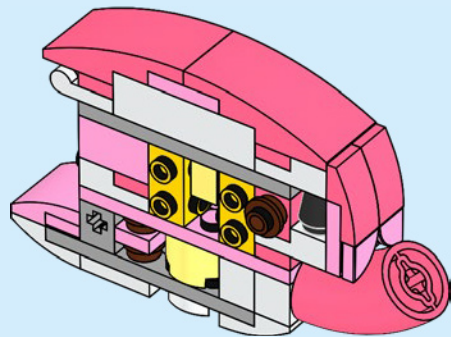

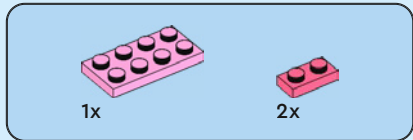
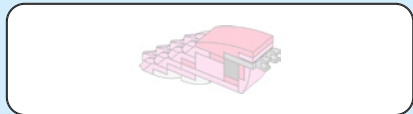

24

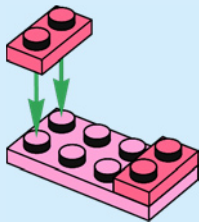

25

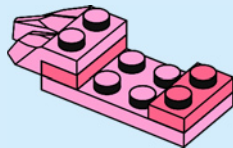

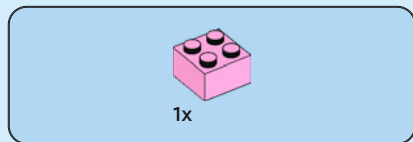

26

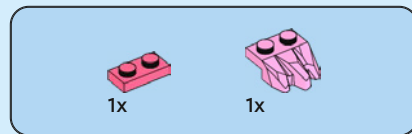
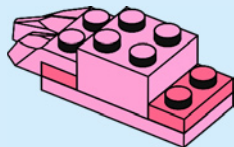

27

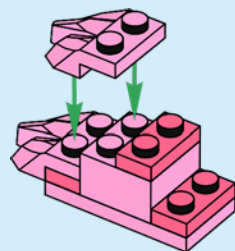



1x

28

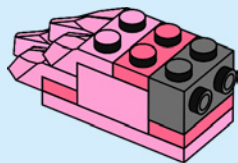

1x



1x

29

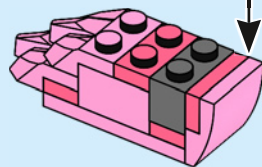
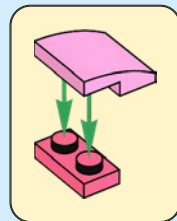

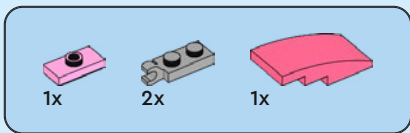

30

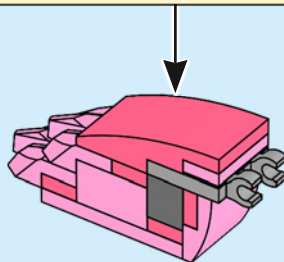
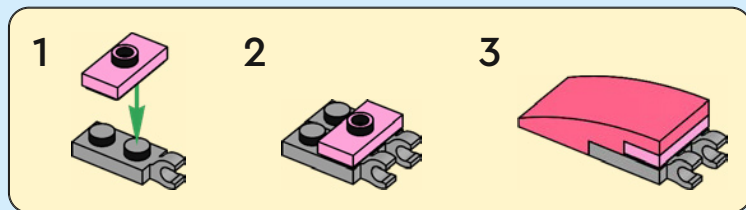



31

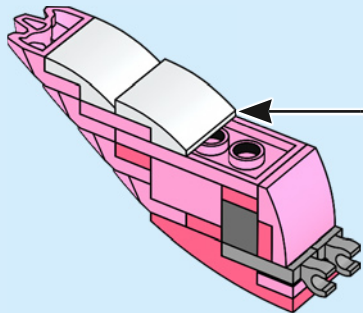
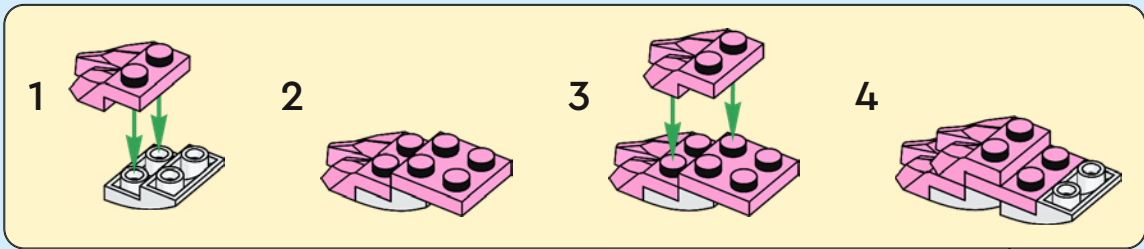

32

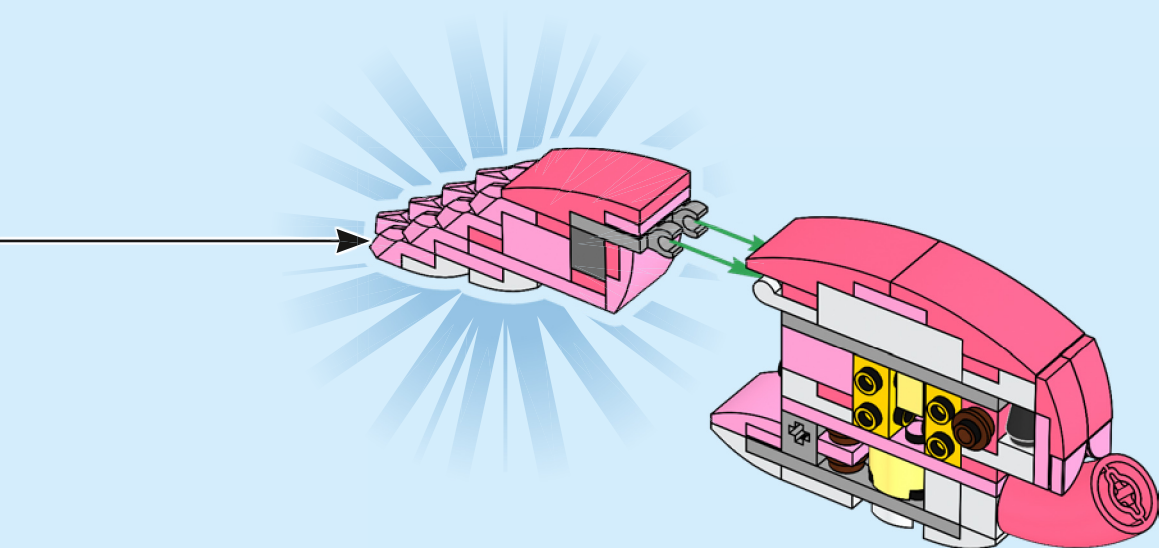

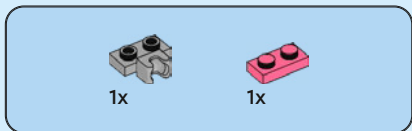
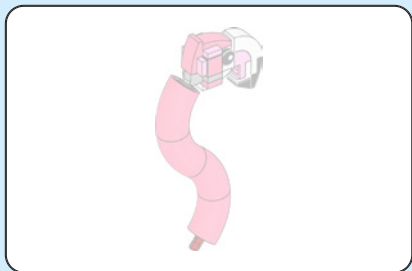

33

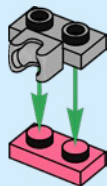

34





2x

35



2x



1x



1x



1x

36

1

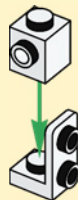

2

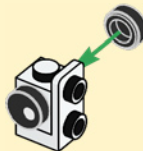

3

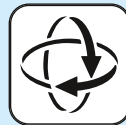
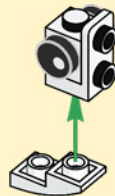



1x

37



1x

38

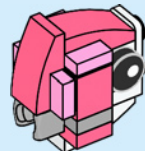

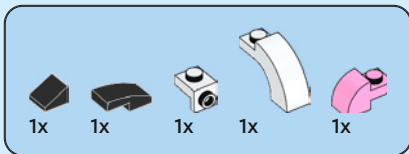

39

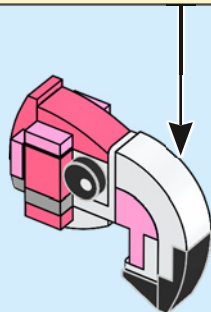
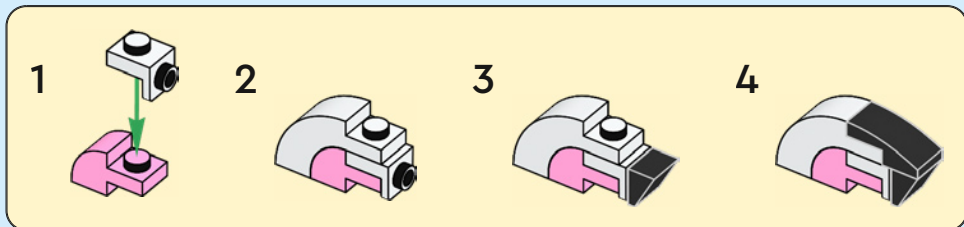

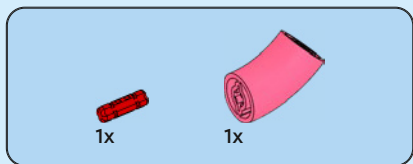

40

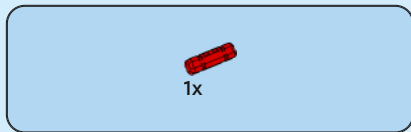
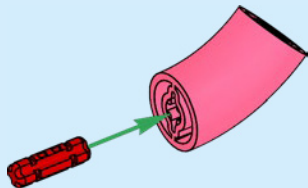

41

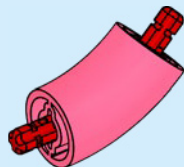

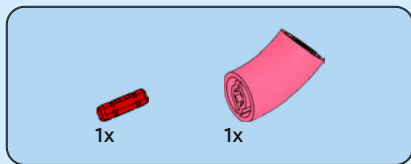

42

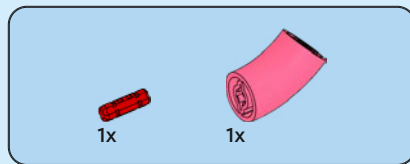
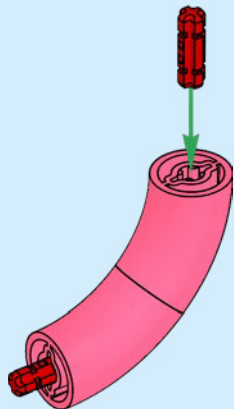

43

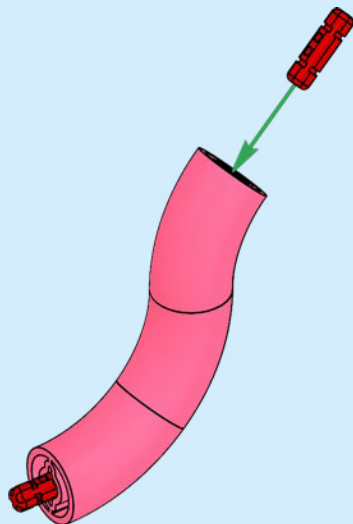

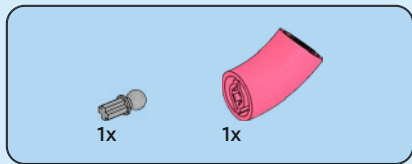

44

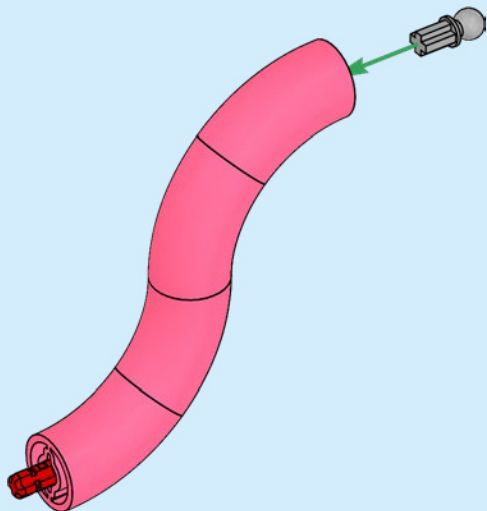

45

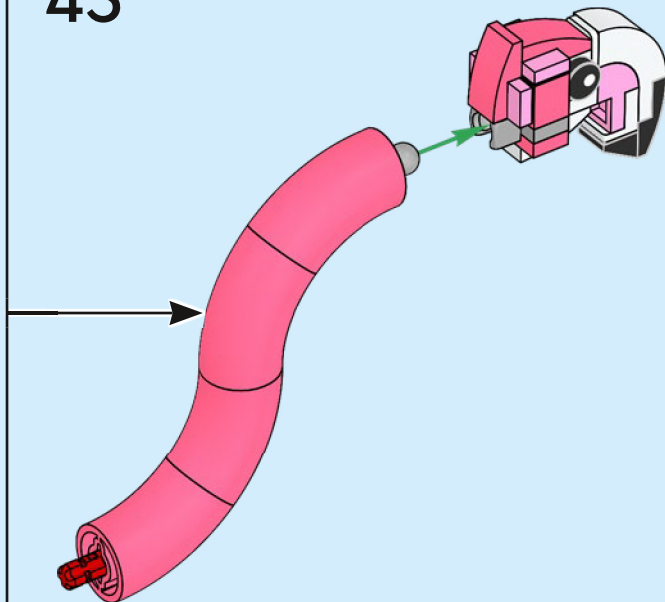

46

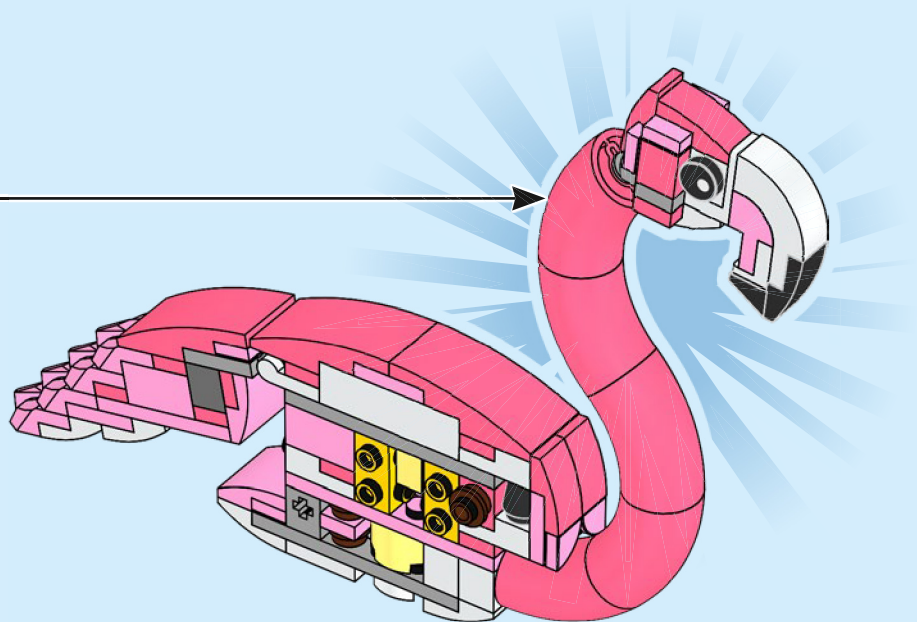

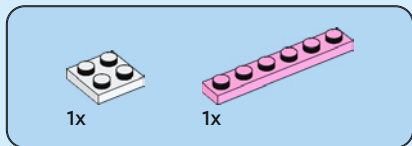
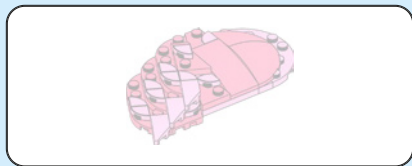

47

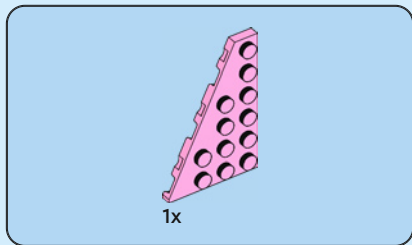
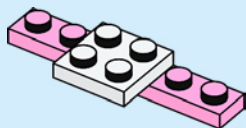

48

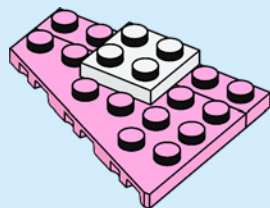



2x

49

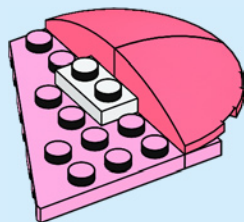

1x

50

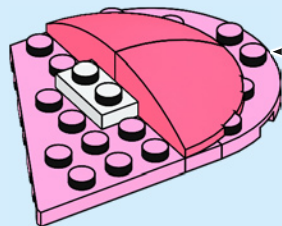
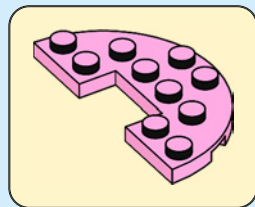



1x

51

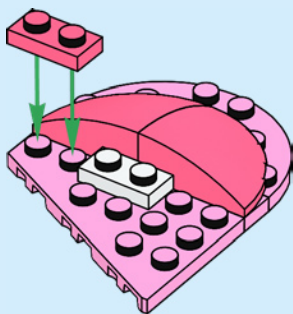

1x

52

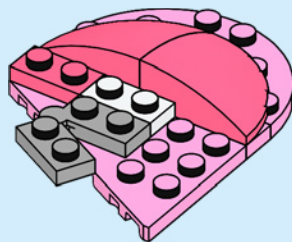

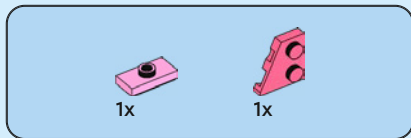

53

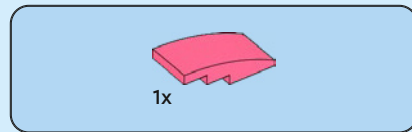
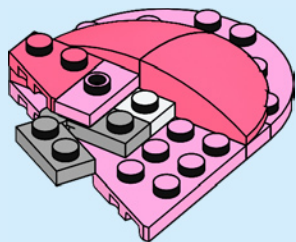

54

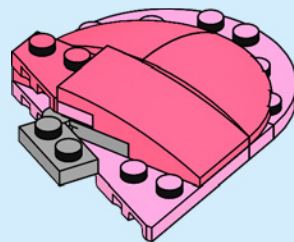



1x

55

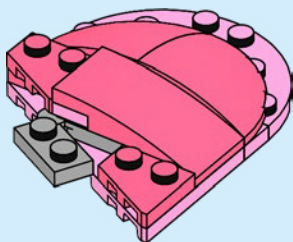

2x

56



2x

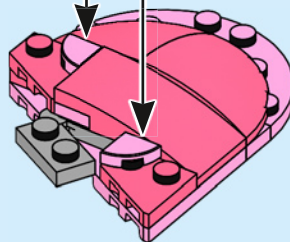

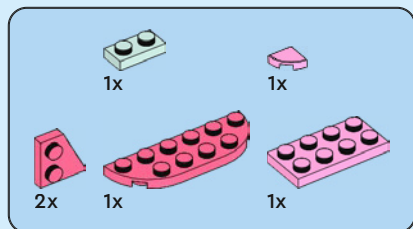

57

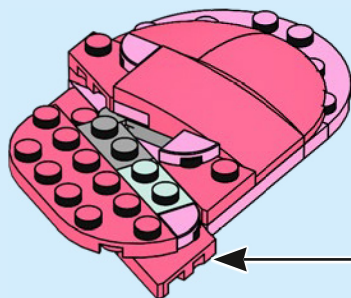
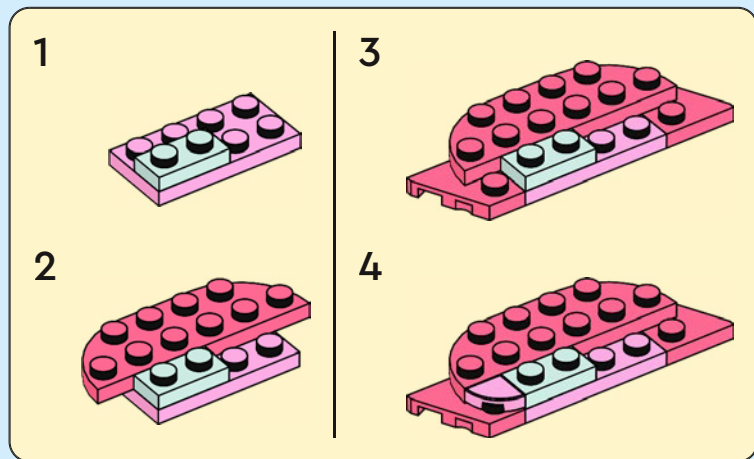

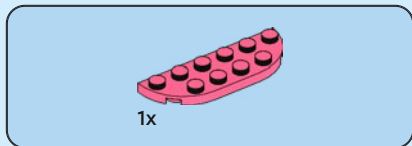

58

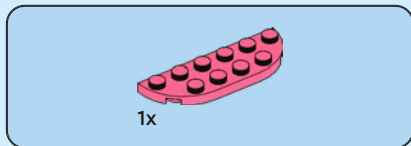
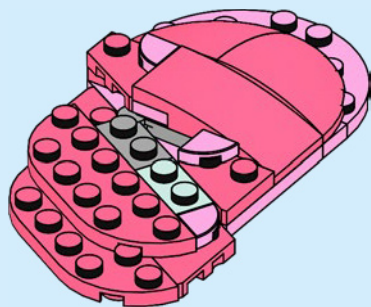

59

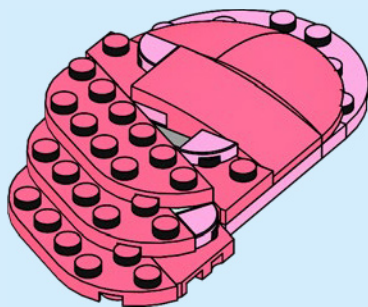



1x



3x

60

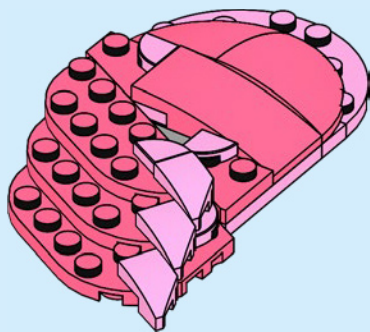

1x



1x

61

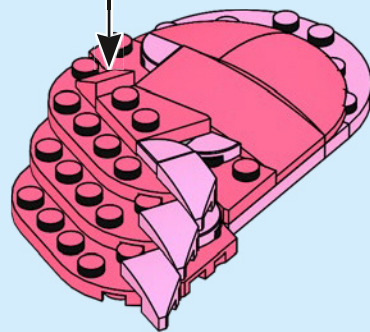



7x

62

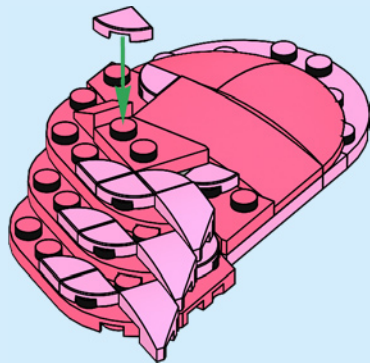

63

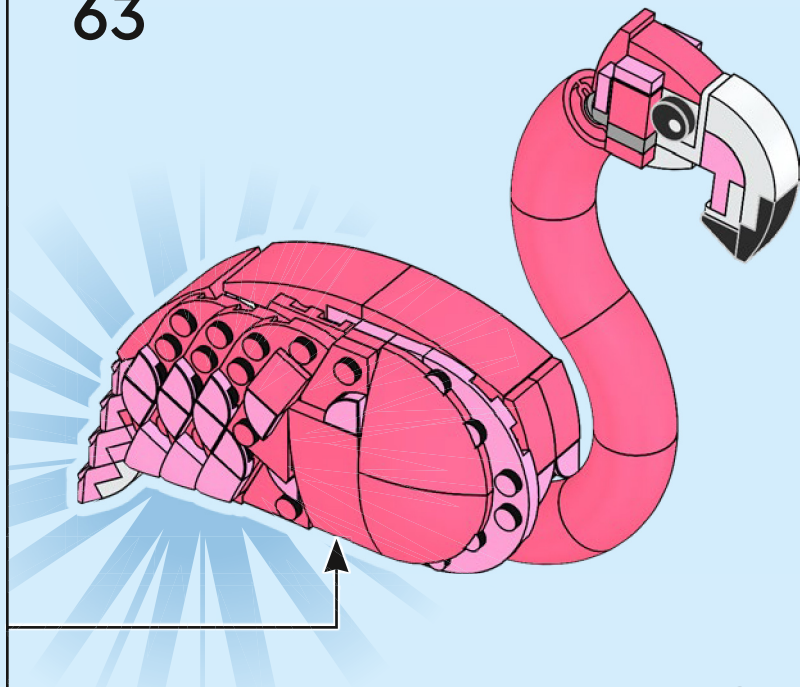



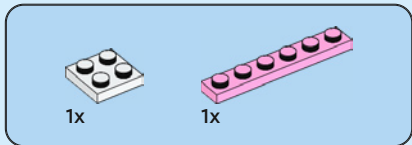
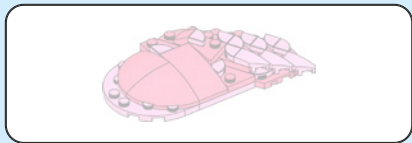

64

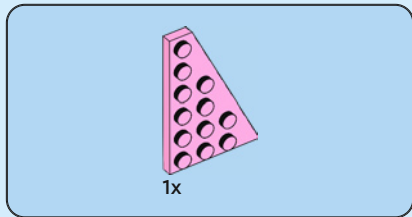
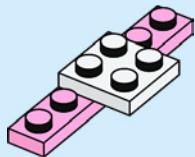

65

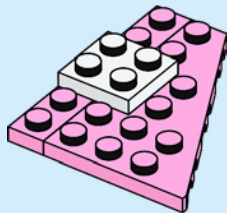



2x

66

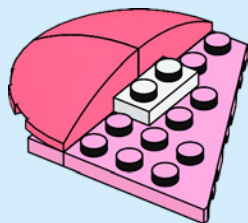

1x

67

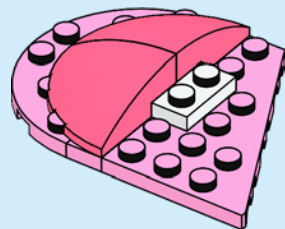



1x

68

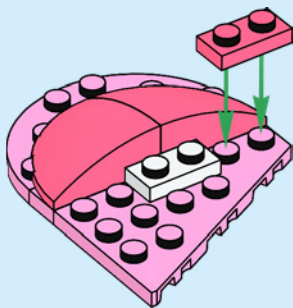

1x

69

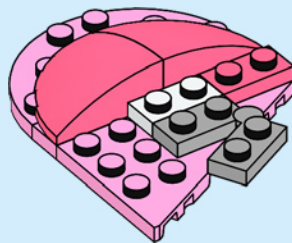

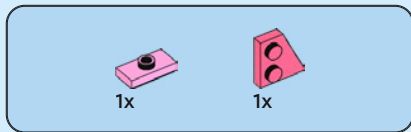

70

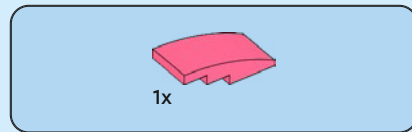
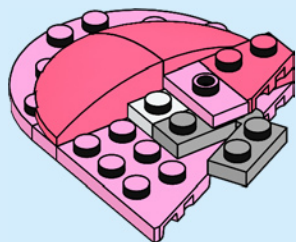

71

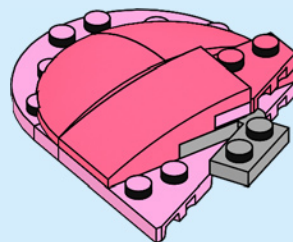



1x

72

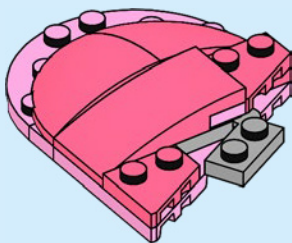

2x

73



2x

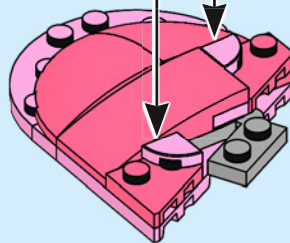

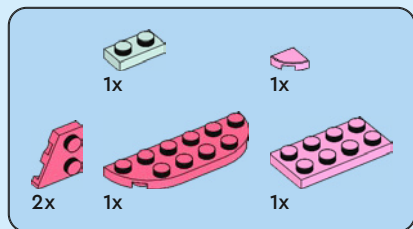

74

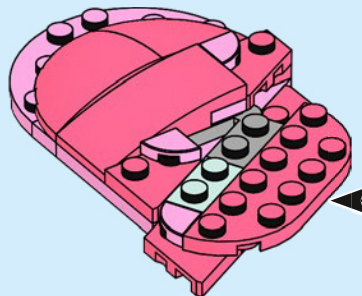
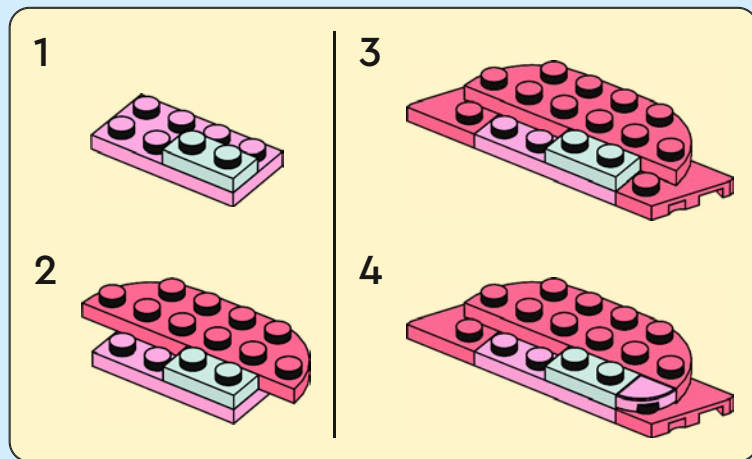

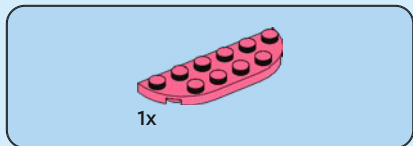

75

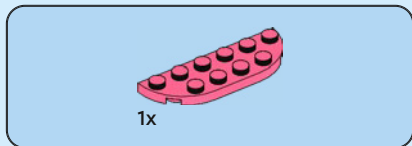
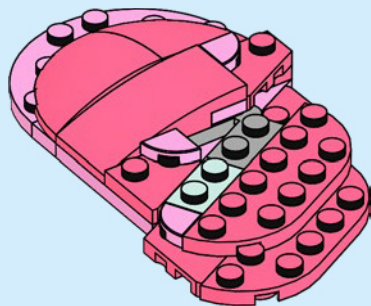

76

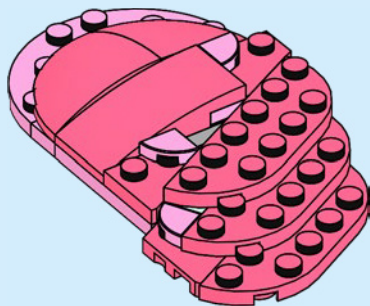



1x



3x

77

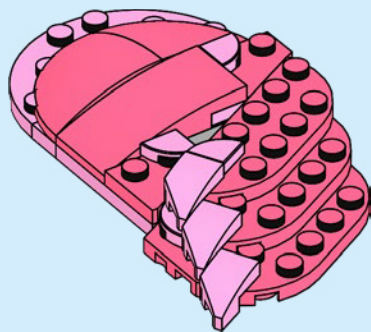

1x



1x

78

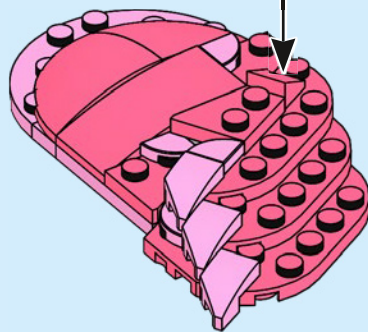
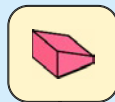



7x

79

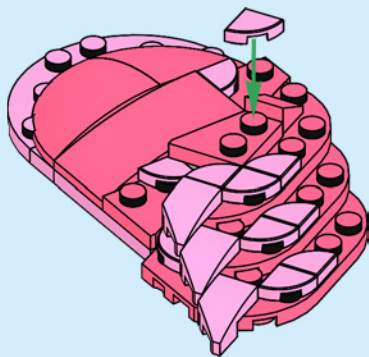

80

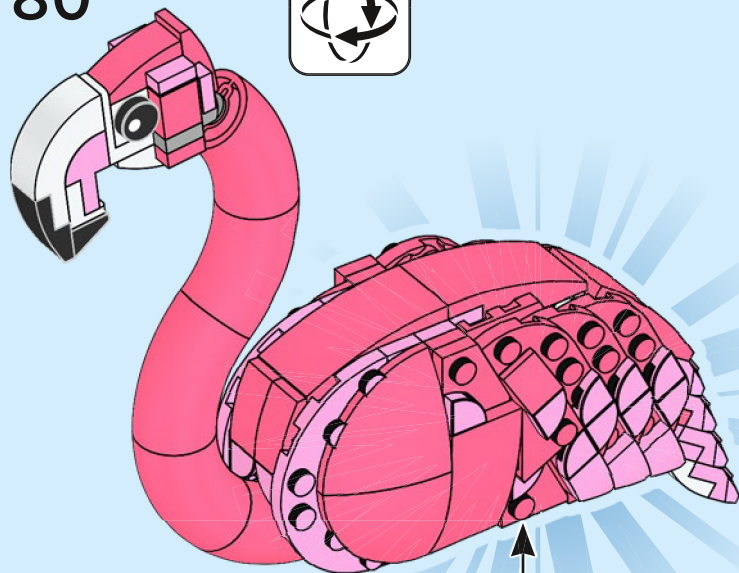



81

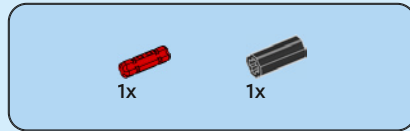
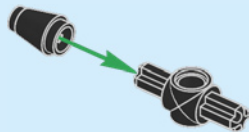

82

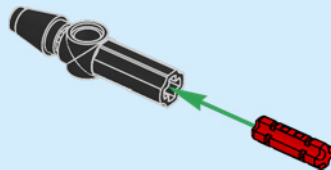



1x

83



1x

84

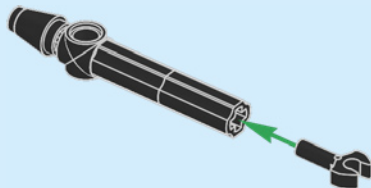



1x

85

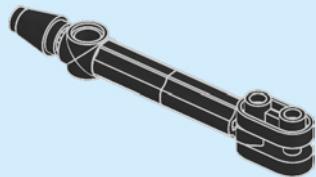

1x

86

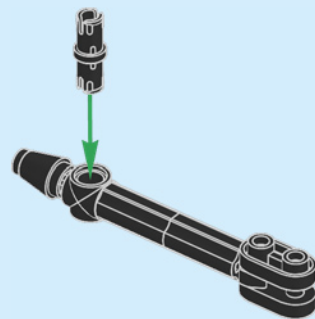

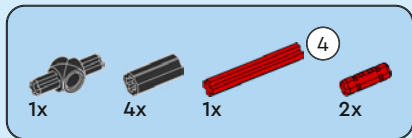
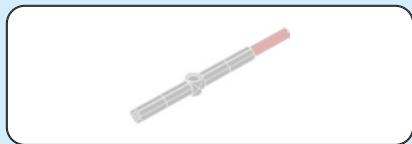

87

1

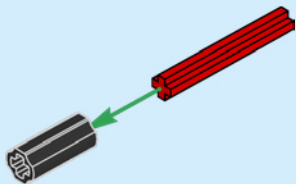

2

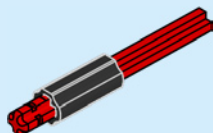

3

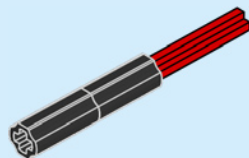

4

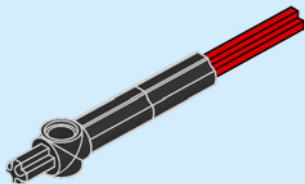

5

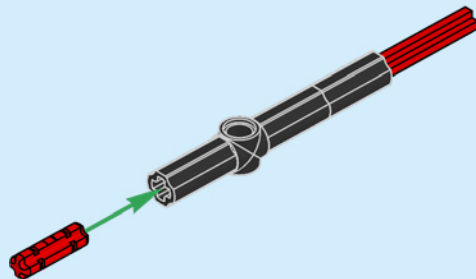

6

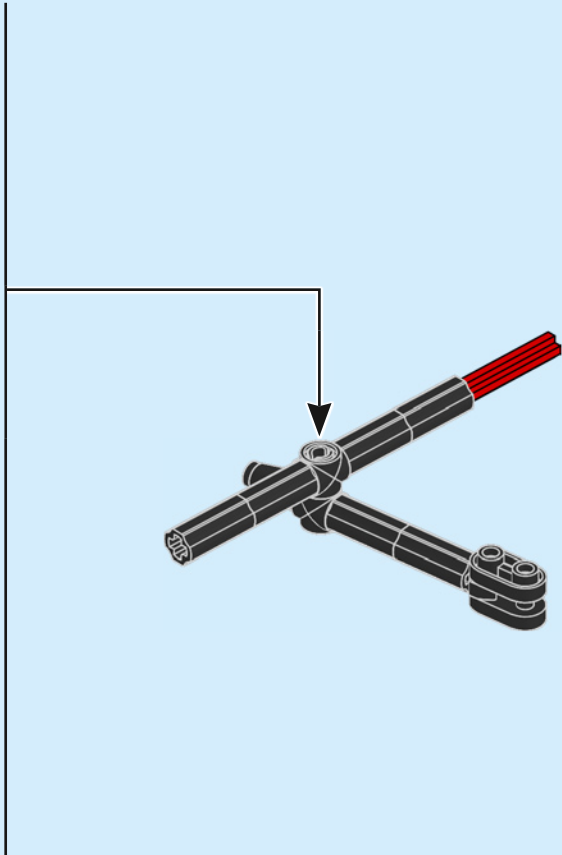
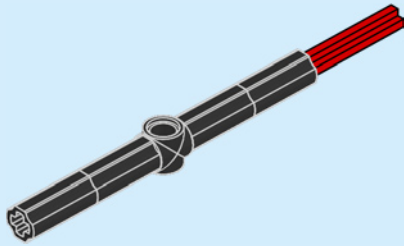

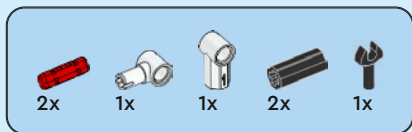

88

1

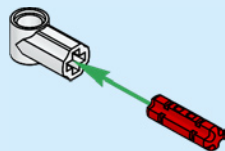

2

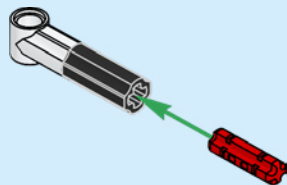

3

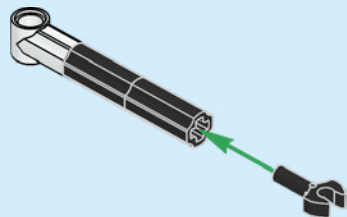

4

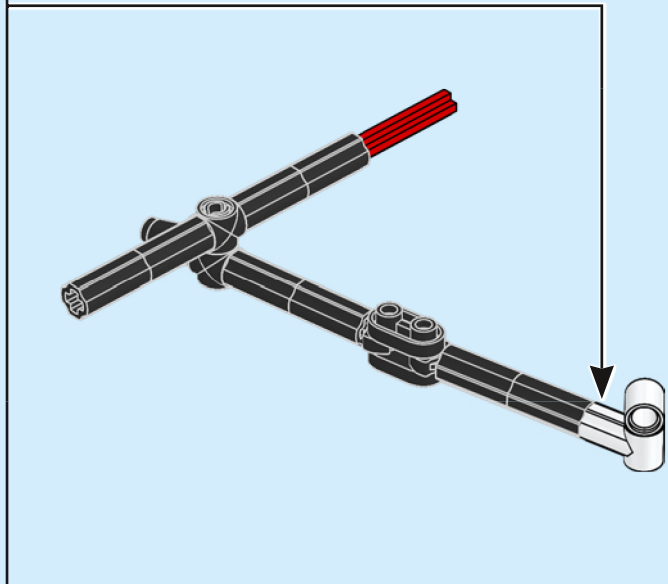
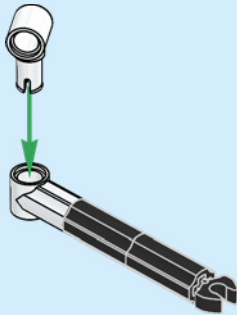

89

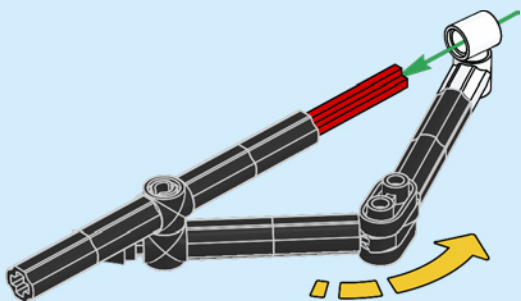

90

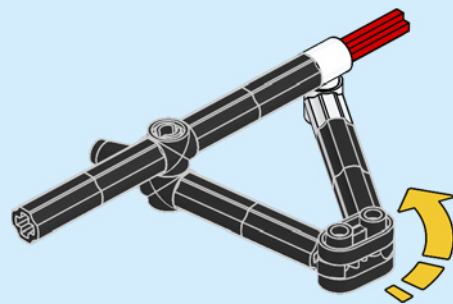

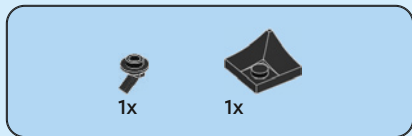

91

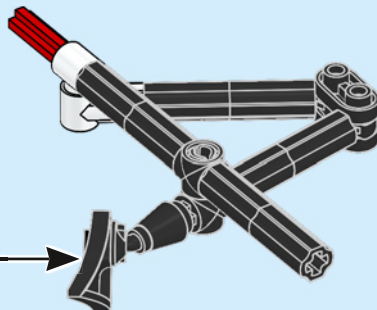
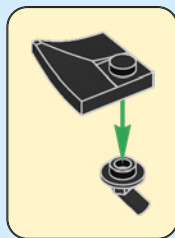

92

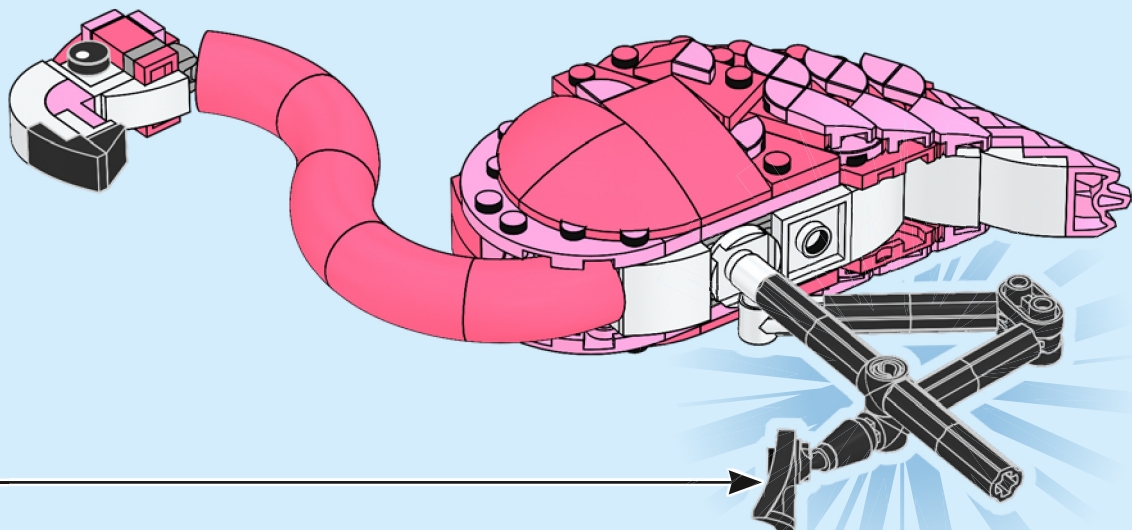
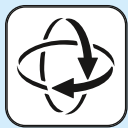

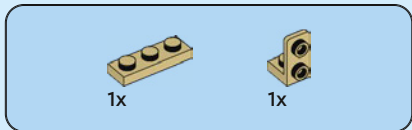

93

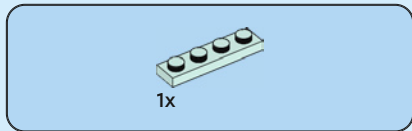
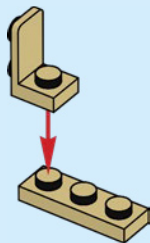

94

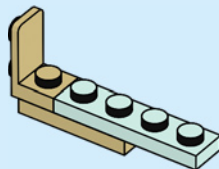



1x

95

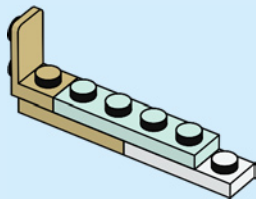

1x

96

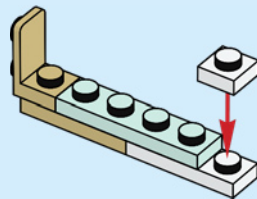

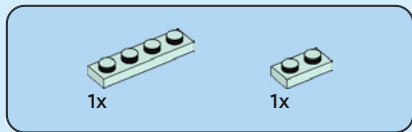

97

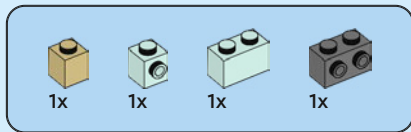
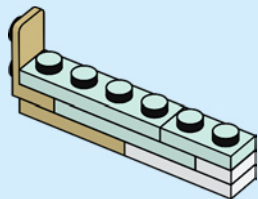

98

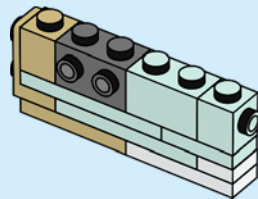

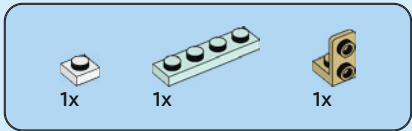

99

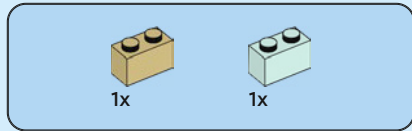
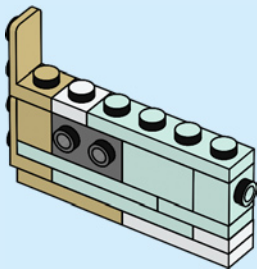

100

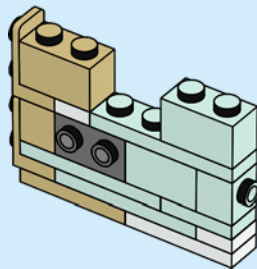

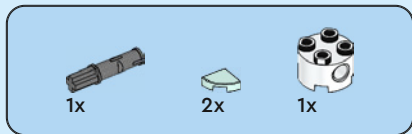

101

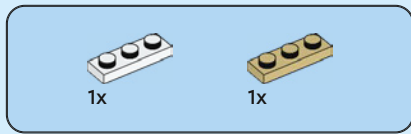
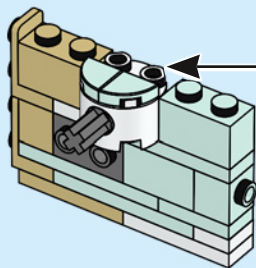
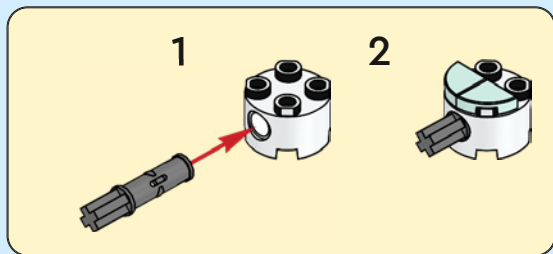

102

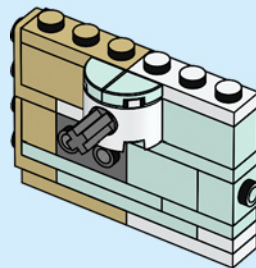

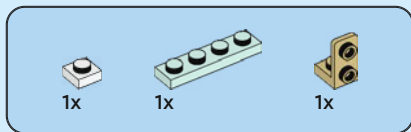

103

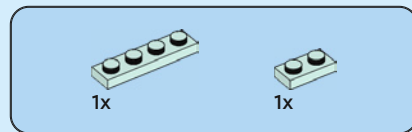
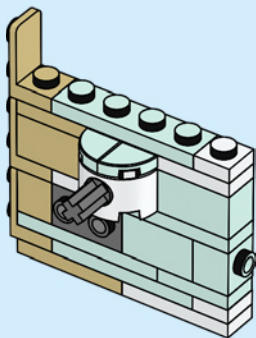

104

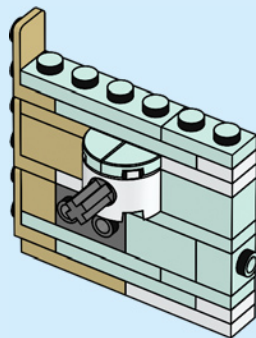

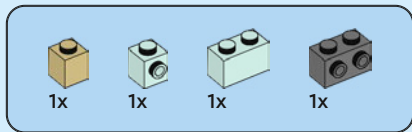

105

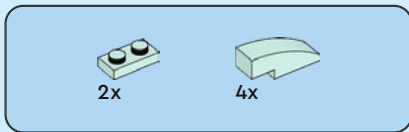
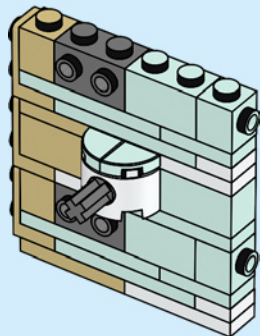

106

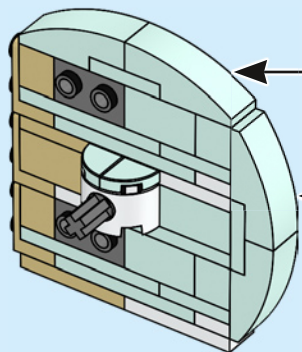
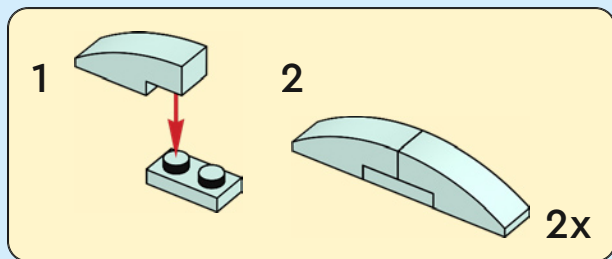

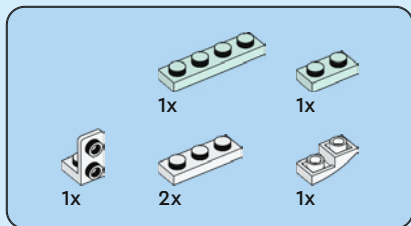

107

1

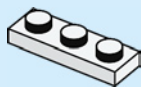

2

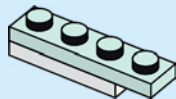

3

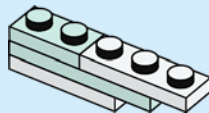

4

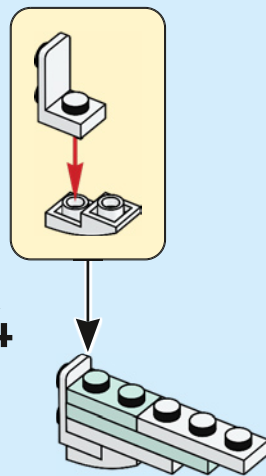

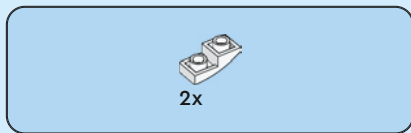
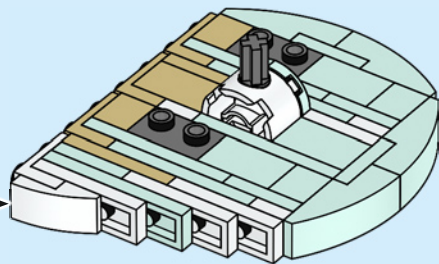

108

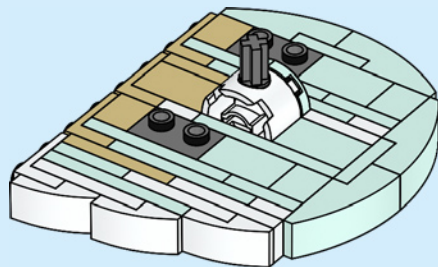

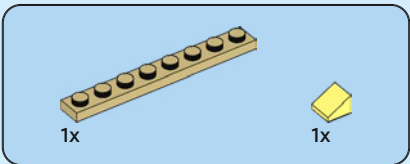

109

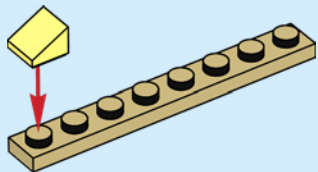

110

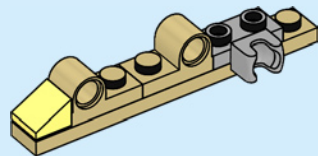



1x



1x



1x

111

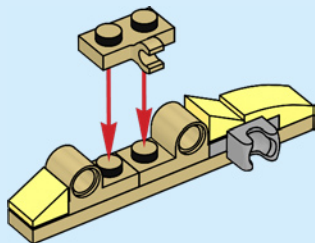

2x

112

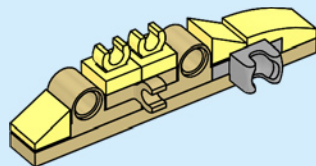



2x

113

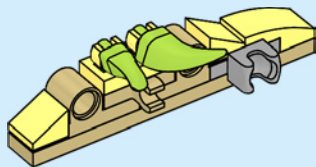

114

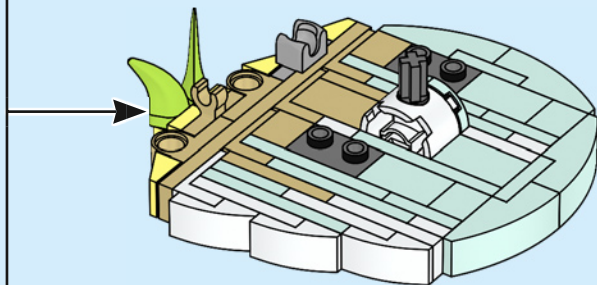

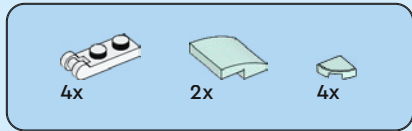

115

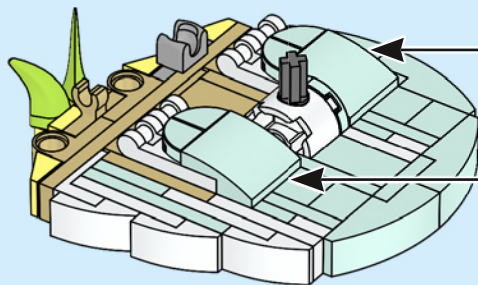
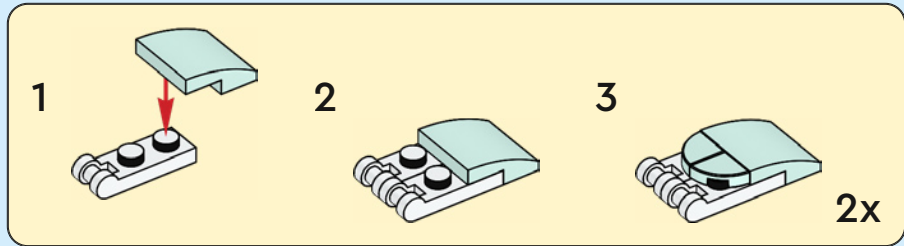



116

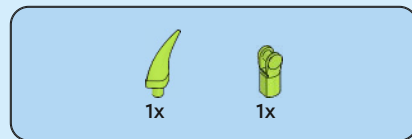
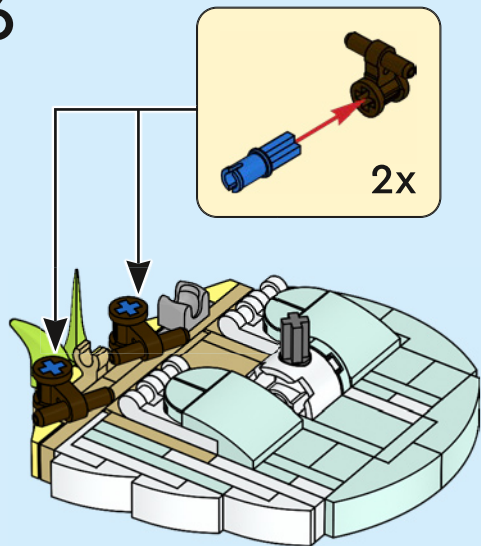

117

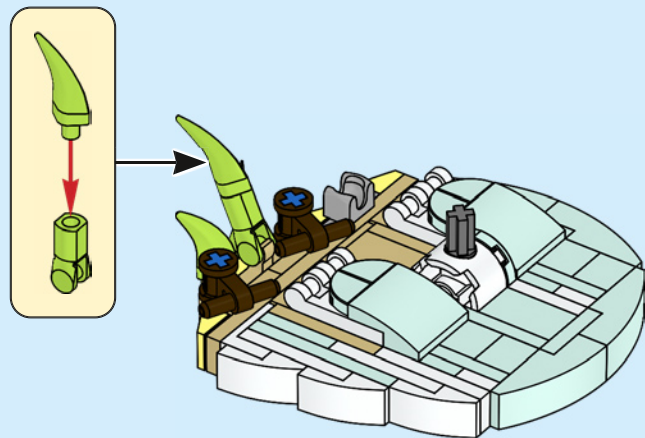



2x



2x



6x



2x



2x

118

1



2

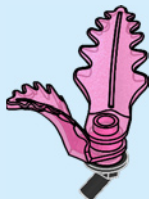

3

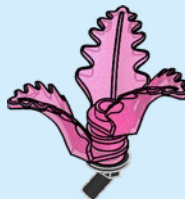

4

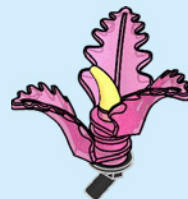

5



2x

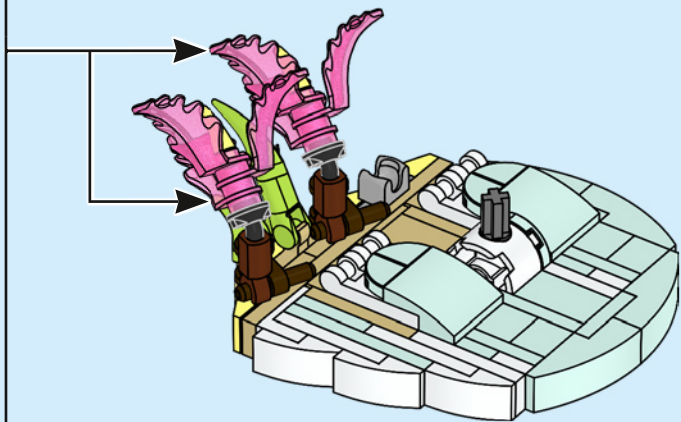



119

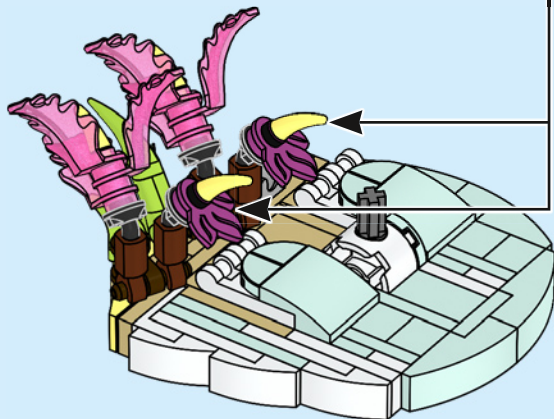
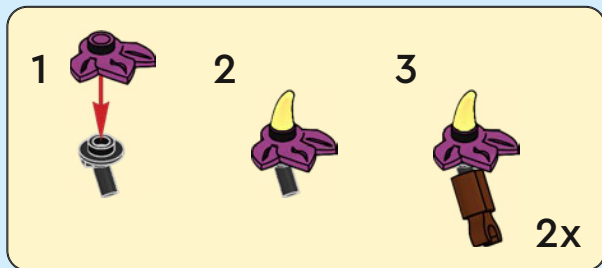



120

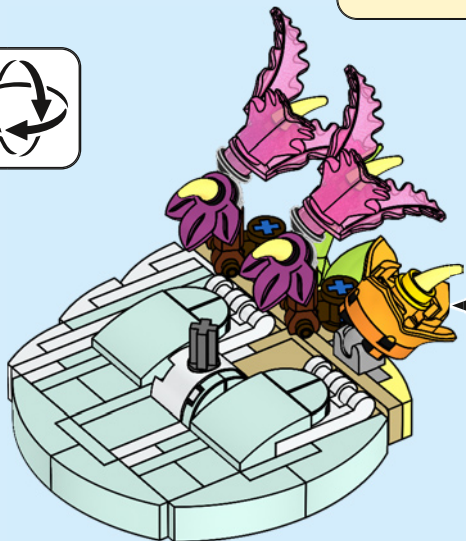

121

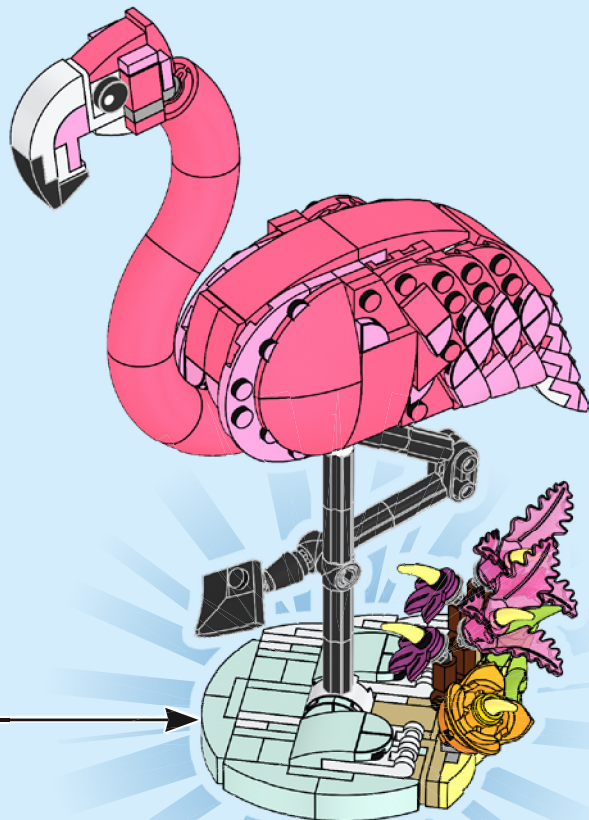



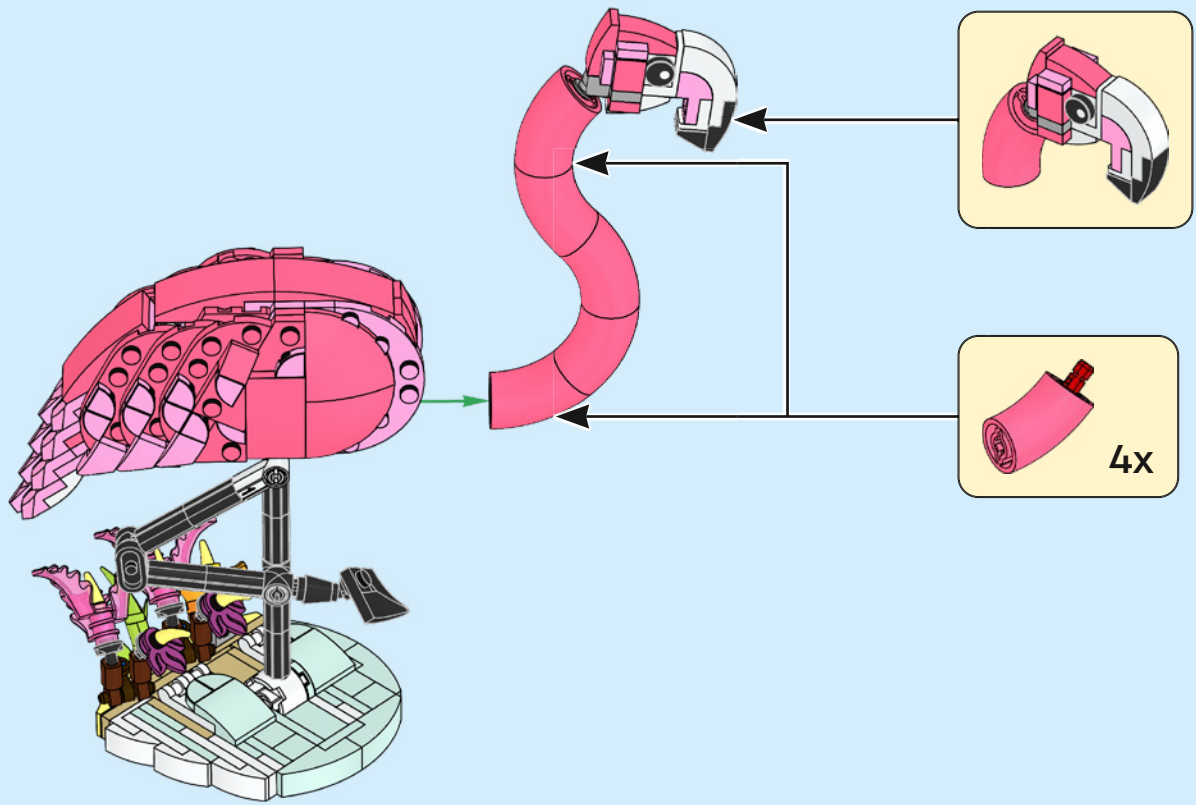

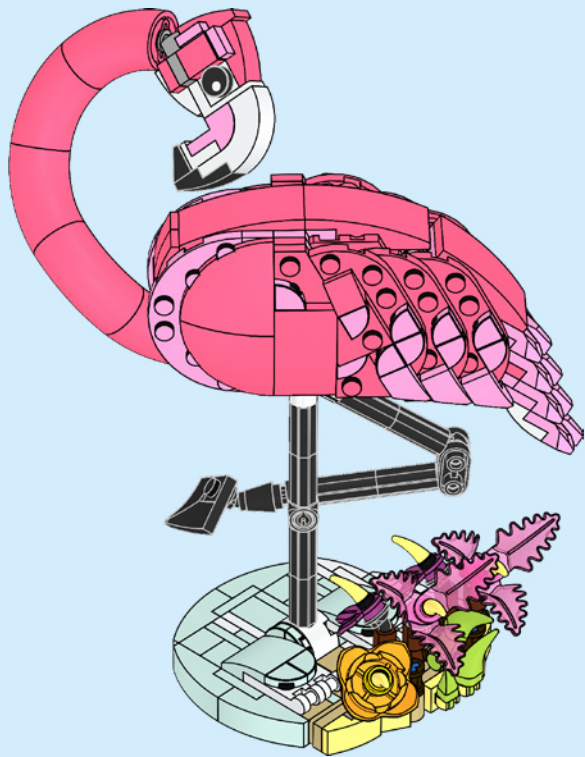
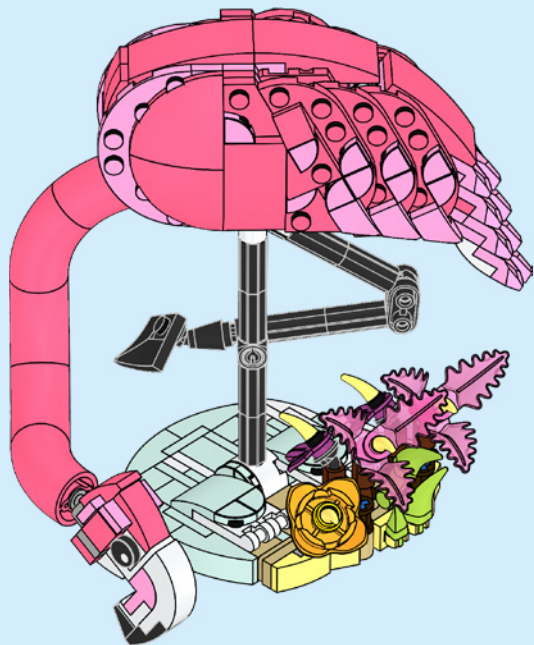

YOU COULD **WIN**



Scan this QR code or go to **LEGO.COM/PRODUCTFEEDBACK** and give us your short feedback about this LEGO® set for a chance to win a cool LEGO prize.

Terms and Conditions apply*

EN: YOU COULD WIN. Terms and Conditions apply* **DE: Du könntest GEWINNEN.** Es gelten die Teilnahmebedingungen* **FR: Tu pourrais GAGNER.** Des conditions s'appliquent* **IT: Potresti VINCERE tu.** Termini e condizioni sono applicabili* **ES: Puedes GANAR.** Aplican términos y condiciones* **PT: PODERÁ GANHAR.** Aplicam-se Termos e Condições* **ZH: 轻松获奖.** 条款和条件适用* **PL: Szansa na WYGRANĄ.** Obowiązuje regulamin* **CS: Máte šanci VYHRÁT.** Platí všeobecné smluvní podmínky* **SK: Máte šancu VYHRAŤ.** Platia všeobecné zmluvné podmienky* **HU: TE IS NYERHETSZ.** Felhasználási feltételek érvényesek* **UA: ВИ МОЖЕТЕ ВИГРАТИ.** Застосовуються загальні положення та умови* **RO: Ai putea CÂȘTIGA.** Se aplică termeni și condiții* **BG: Можете да СПЕЧЕЛИТЕ.** Има определени правила и условия* **LV: Tu vari LAIMĒT.** Ir spēkā noteikumi un nosacījumi.* **ET: Sul on võimalus VÕITA.** Kehtivad tingimused* **LT: Jūs galite LAIMĖTI.** Taikomos sąlygos*

*[LEGO.com/productfeedback-terms](https://www.lego.com/productfeedback-terms)