



# Friends

42643



Q [LEGO® Builder](#)



LEGO.com/sustainable-packaging



FR  
DONNEZ  
OU  
RECYCLEZ



ASSOCIATION

OU



MAGASIN

OU



DÉCHÈTERIE

Adresses sur [quefairedemesdechets.fr](http://quefairedemesdechets.fr)



Q LEGO® Builder

# BUILDER



Apple and the Apple logo are trademarks of Apple Inc., registered in the U.S. and other countries and regions. App Store is a service mark of Apple Inc. Google Play and the Google Play logo are trademarks of Google LLC. Tencent and the Tencent logo are trademarks of Tencent Inc.

Q [LEGO.com/devicecheck](https://www.lego.com/devicecheck)

**EN** Ask parents' permission before going online | **DE** Eltern um Erlaubnis bitten, bevor du online gehst | **FR** Demande l'autorisation d'un parent avant d'aller en ligne | **IT** Chiedi il permesso ai tuoi genitori prima di andare online | **ES** Pídeles permiso a tus papás antes de conectarte a Internet | **PT** Pede autorização aos pais antes de acederes online | **ZH** 上网前应先征得父母的同意 | **PL** Poproś rodziców o zgodę, zanim wejdiesz do Internetu | **CS** Než půjdeš na internet, požádej rodiče o svolení | **SK** Skôr než půjdeš na internet, vypýtaj si povolenie od rodičov | **HU** Kérj szülői engedélyt, mielőtt online csatlakoznál! | **RO** Cere permisiunea părinților înainte de a te conecta online | **BG** Поискайте разрешение от родител, преди да влезете онлайн | **LV** Pirms došanās tiešsaistē palūdz atļauju vecākiem | **ET** Enne Interneti kasutamist küsi vanematelt luba | **LT** Prieš prisijungdami prie interneto, atsiklauskite tėvų



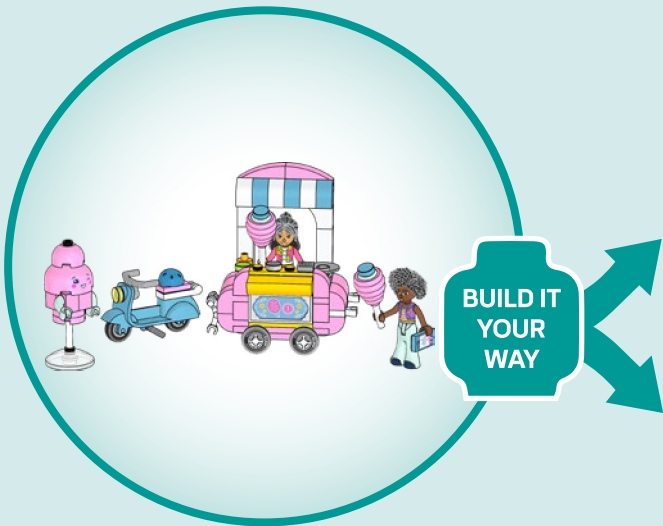

**EN** Build It Your Way | **DE** Bau, wie du willst | **FR** Construisez à votre façon | **IT** Costruiscilo come vuoi tu | **ES** Constrúyelo a tu manera | **PT** Constrói à Tua Maneira | **ZH** 自由拼搭 | **PL** Zbuduj po swojemu | **CS** Postavte to po svém | **SK** Postavte to po svojom | **HU** Építs kedved szerint! | **RO** Construiște așa cum dorești | **BG** Постройте го по своя начин | **LV** Būvē tieši tā, kā vēlies | **ET** Ehita enda moodi | **LT** Sukonstruokite savaip



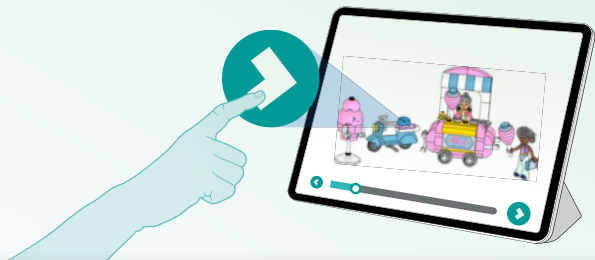



**AVERTISSEMENT : RISQUE D'ÉTOUFFEMENT.**

Le jouet contient des petites pièces ainsi qu'une petite boule.  
Il ne convient pas aux enfants de moins de 3 ans.



**ADVERTENCIA: PELIGRO DE ASFIXIA.**

Juguete que contiene partes pequeñas y una pelota pequeña.  
No recomendado para niños menores de 3 años.



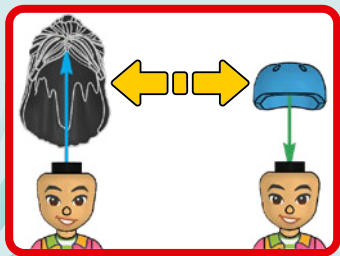
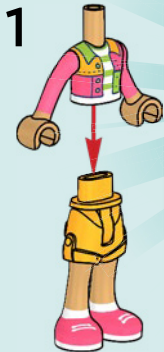

# LIANN



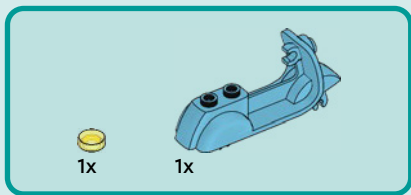

1

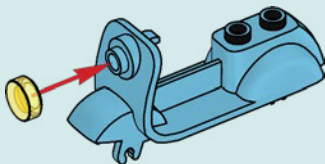



1x

2

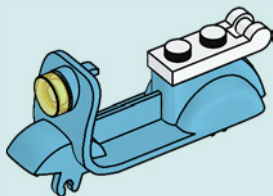

10





1x

3

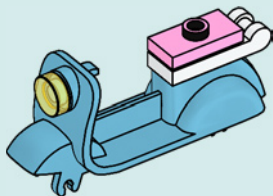



2x

4

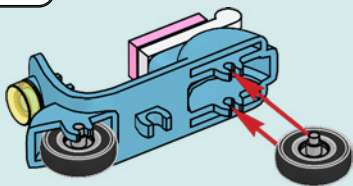





1x

5

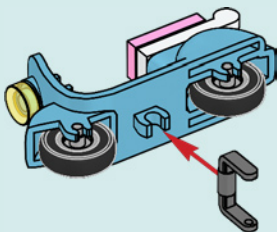



1x

6

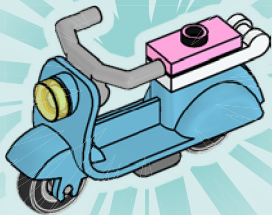



2x

1

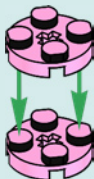



1x

2





2x

3

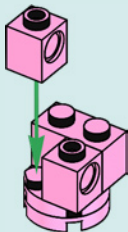



1x

4





2x

5

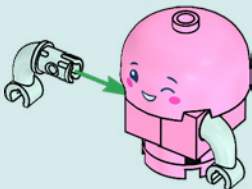



1x

6



20







1x

7

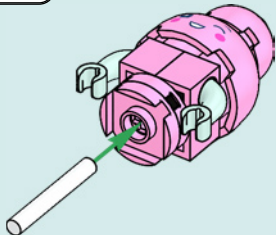

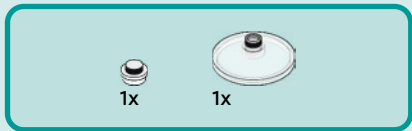

8

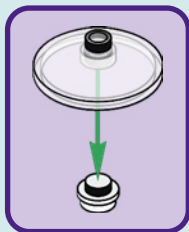

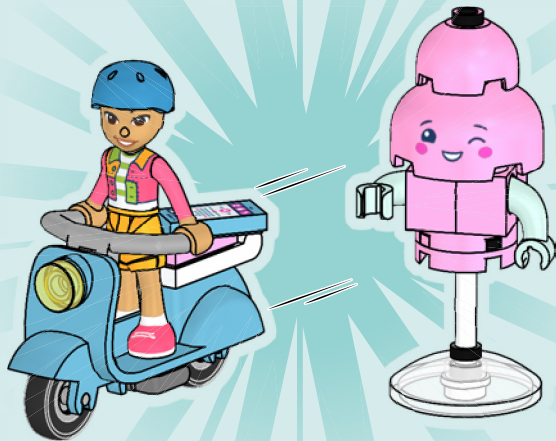



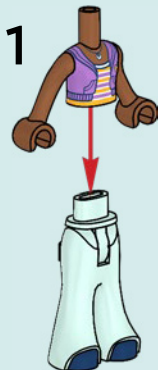

# JAMILA



1x



1x

# 1

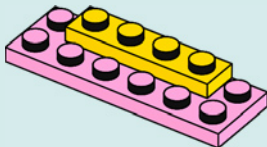



1x

2

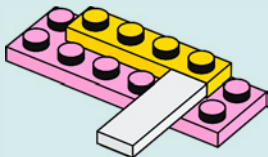



1x

3

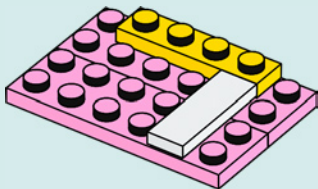





1x



2x

4

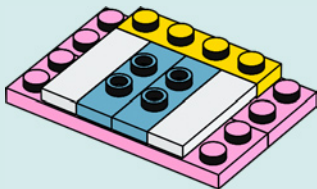



4x

5

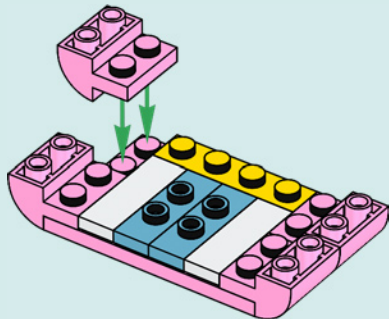

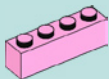

2x

6

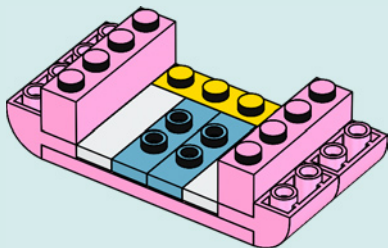



2x

7

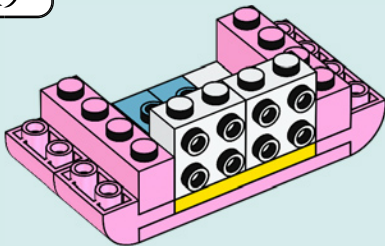



1x



1x

8

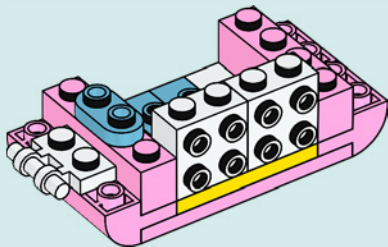



2x



1x

9

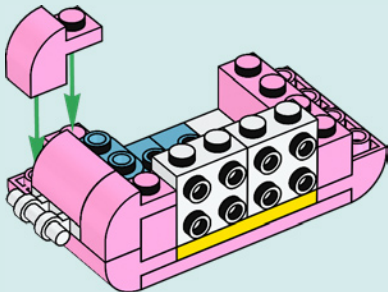



1x



2x

# 10

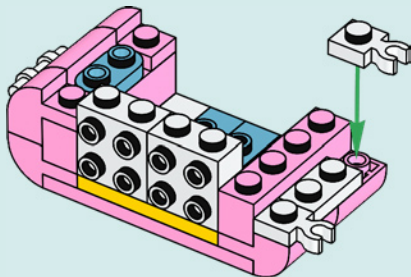



1x

11

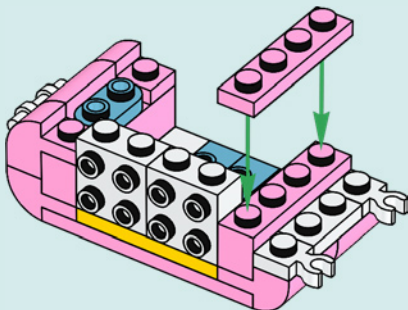





2x

12

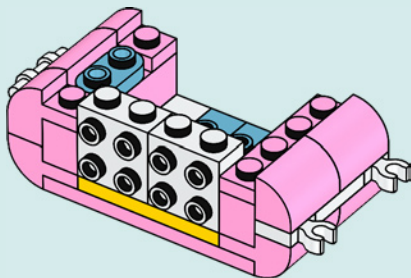



1x



1x

# 13

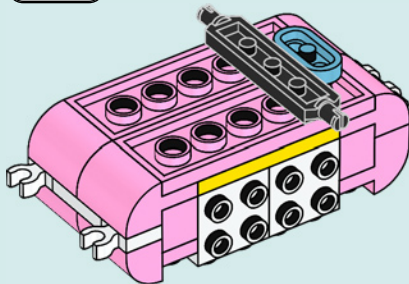



1x

14

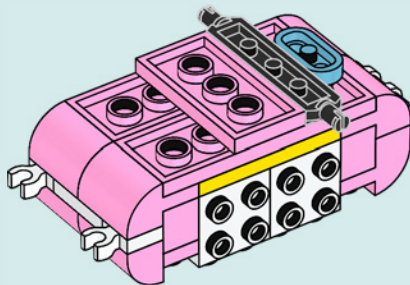



1x



1x

# 15

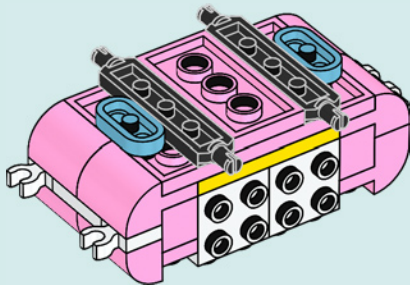





2x

16

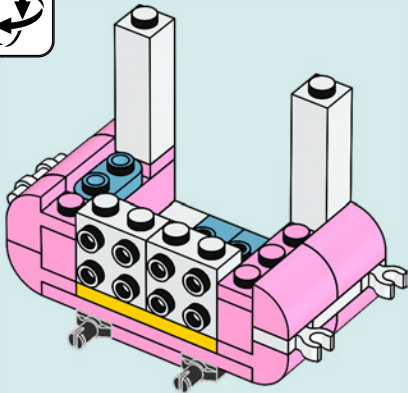



1x



1x



1x



1x

# 17

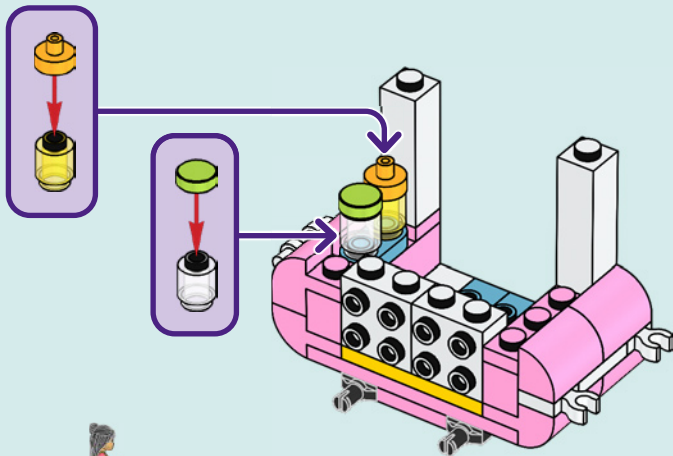



1x

18

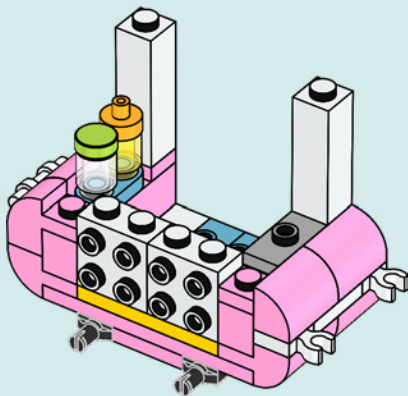





1x



1x

19

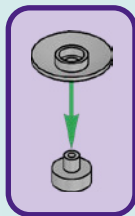
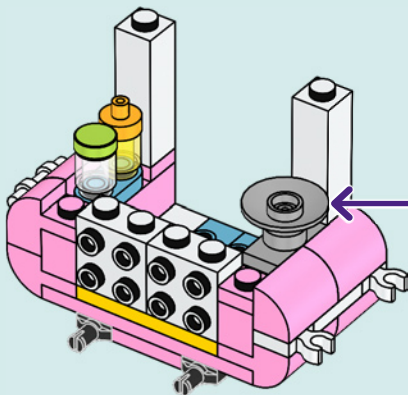



2x

20

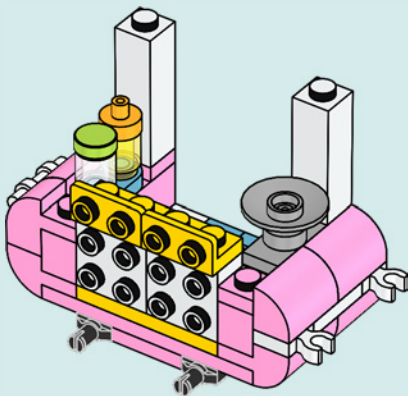



2x

21

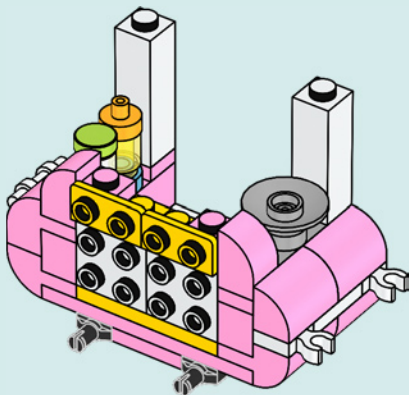



1x

22

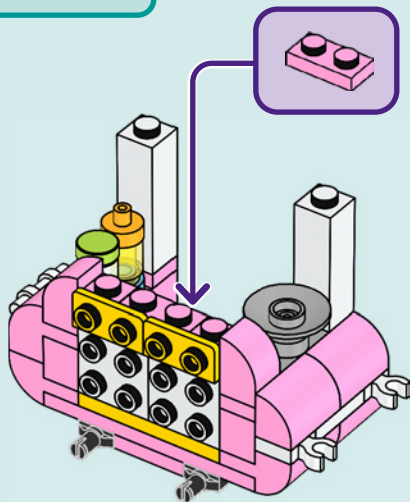



1x

23

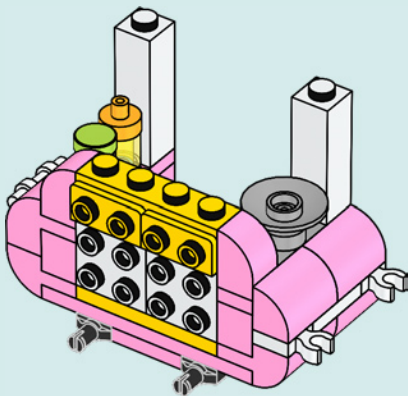



1x



1x

# 24

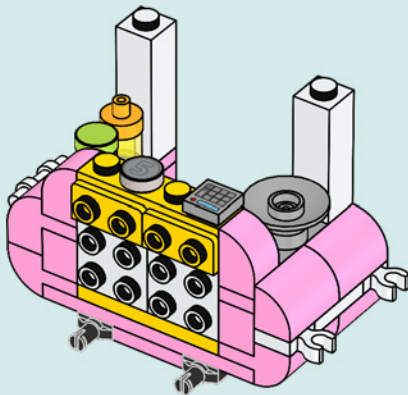



1x

# 25

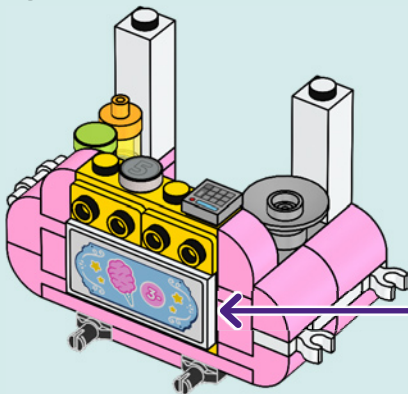

1

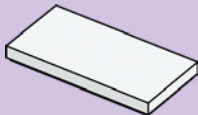

2

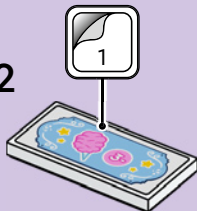

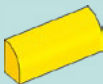

1x

26

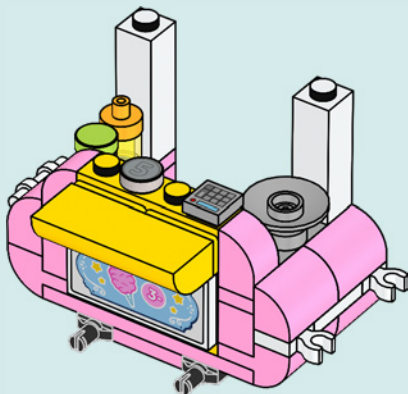



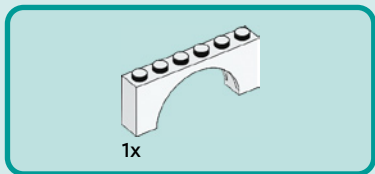
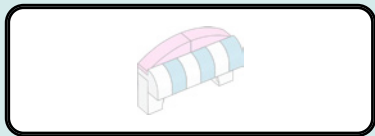

27

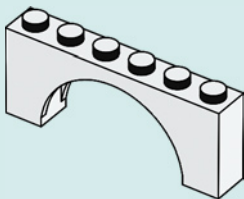



3x



3x

# 28

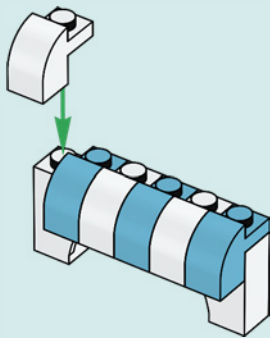



1x



1x

# 29

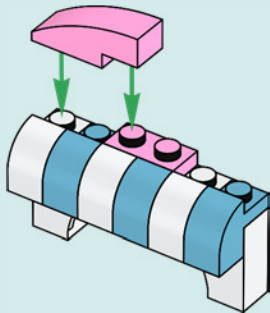



1x

30

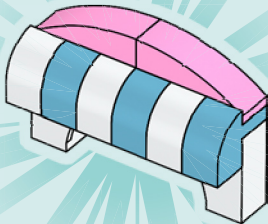

31

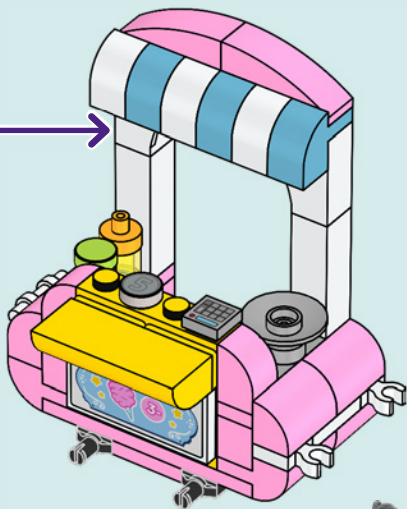

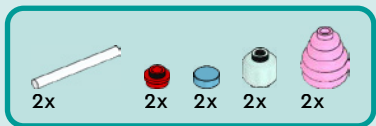

32

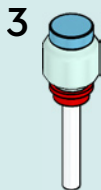
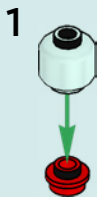

2x

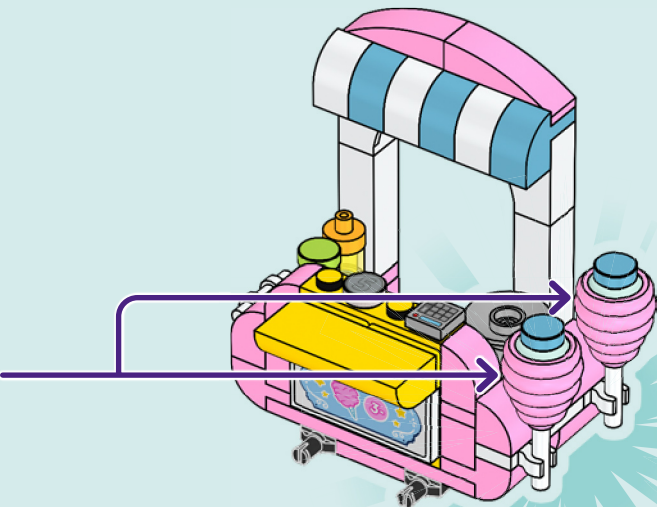



4x



4x

# 33

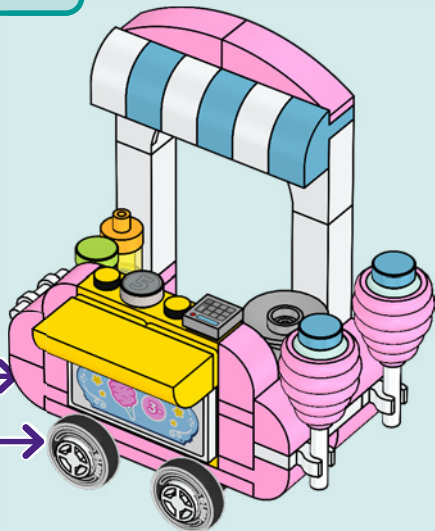
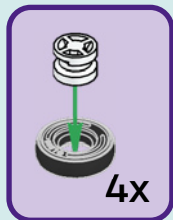





1x

34

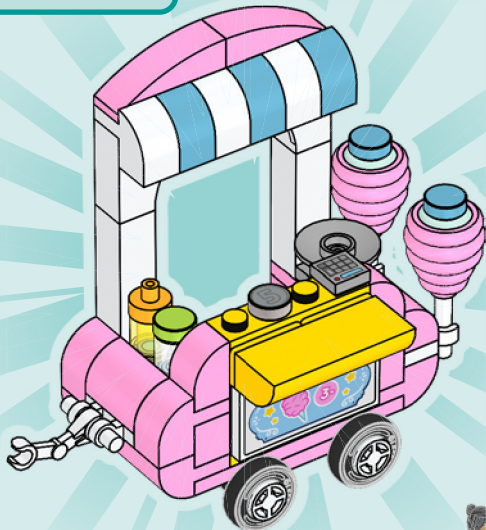

35

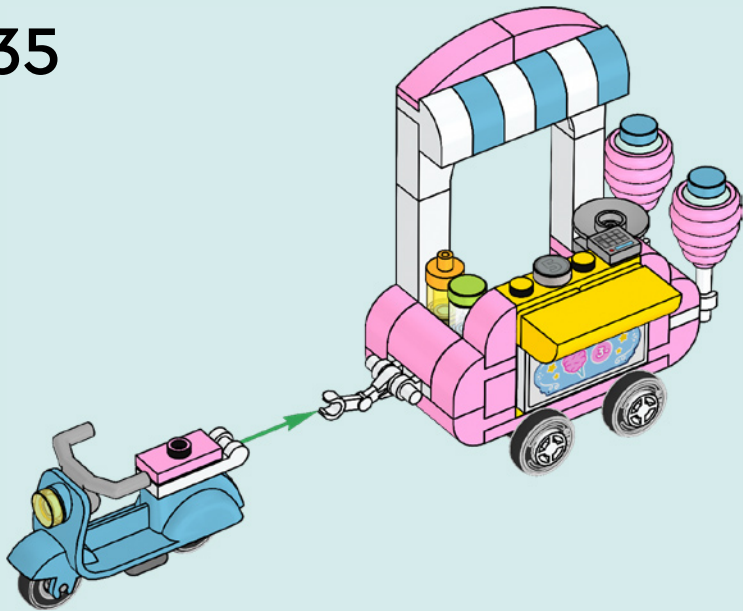

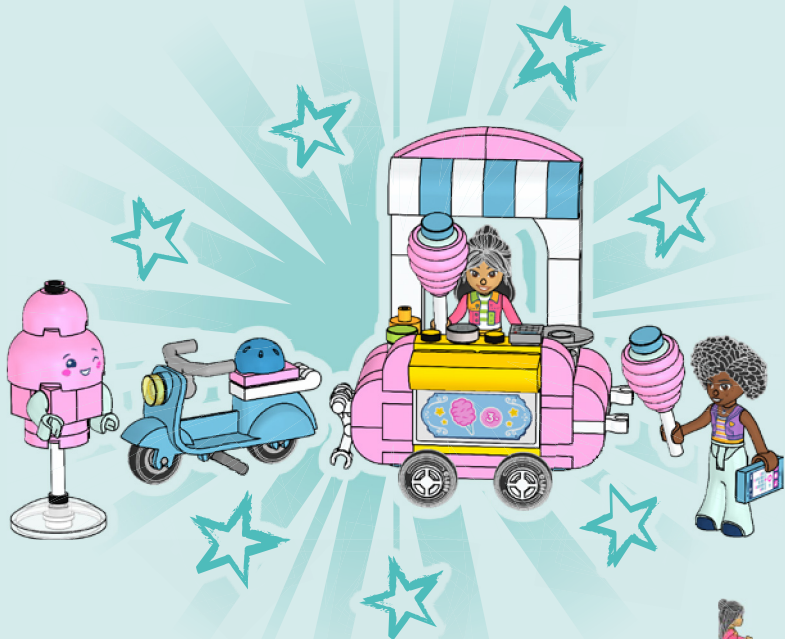



# Friends™

WATCH  
SERIES  
ONLINE



WATCH SERIES ONLINE / SCHAU DIR DIE SERIE ONLINE AN / REGARDE LA SÉRIE EN LIGNE / GUARDA LA SERIE ONLINE / MIRA LA SERIE EN INTERNET / ASSISTIR À SÉRIE ONLINE / 在线观剧 / OGLĄDAJ SERIAL W INTERNECIE / SLEDUJ SERIAŁ ONLINE / POZRI SI SERIAŁ ONLINE / NÉZD A SOROZATOT ONLINE / VIZIONEAZĂ SERIALUL ONLINE / ГЛЕДАЙТЕ СЕРИАЛА ОНЛАЙН / SKATIES SERIAĻU TIEŠSAISTĒ / VAATA SARJA VEEBIST / ŽIŪRĒK SERIALĄ INTERNETU

**LEGO**

**Friends**



**42652**

**42663**



**42650**



**42649**







2x  
4654128



1x  
4517993



4x  
6476741



1x  
6481618



2x  
6133062



2x  
4518890

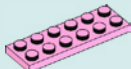

2x  
4625633



1x  
6002148



1x  
6204535



1x  
6329604



1x  
6225073



2x  
6322819



3x  
6396673



3x  
6335566



1x  
6329586



2x  
6465291



1x  
6427250



2x  
6454738



2x  
6494362



1x  
6416494



1x  
6416546



1x  
6466744



1x  
6467217



1x  
6521860



LEGO.com/service

YOU COULD **WIN**



Scan this QR code or go to  
**LEGO.COM/PRODUCTFEEDBACK** and give us  
your short feedback about this LEGO® set for  
a chance to win a cool LEGO prize.

Terms and Conditions apply\*

**EN: YOU COULD WIN.** Terms and Conditions apply\* **DE: Du könntest GEWINNEN.** Es gelten die Teilnahmebedingungen\* **FR: Tu pourrais GAGNER.** Des conditions s'appliquent\* **IT: Potresti VINCERE tu.** Termini e condizioni sono applicabili\* **ES: Puedes GANAR.** Aplican términos y condiciones\* **PT: Poderá GANHAR.** Aplicam-se termos e condições\* **ZH: 轻松获奖.** 条款和条件适用\* **PL: Szansa na WYGRANĄ.** Obowiązują warunki korzystania\* **CS: Máte šanci VYHRÁT.** Platí všeobecné smluvní podmínky\* **SK: Máte šancu VYHRÁŤ.** Platia všeobecné zmluvné podmienky\* **HU: TE IS NYERHETSZ.** Felhasználási feltételek érvényesek\* **RO: Ai putea CÂȘTIGA.** Se aplică termeni și condiții\* **BG: Можете да СПЕЧЕЛИТЕ.** Има определени правила и условия\* **LV: Tu vari LAIMĒT.** Ir spēkā noteikumi un nosacījumi.\* **ET: Sul on võimalus VÕITA.** Kehtivad tingimused\* **LT: Jūs galite LAIMĖTI.** Taikomos sąlygos\*

\*[LEGO.com/productfeedback-terms](https://lego.com/productfeedback-terms)