



# Friends

42641



Q LEGO® Builder



LEGO.com/sustainable-packaging



**FR**  
**DONNEZ**  
OU  
**RECYCLEZ**

 OU  OU 

ASSOCIATION    MAGASIN    DÉCHÈTERIE

Adresses sur [quefairedemesdechets.fr](http://quefairedemesdechets.fr)



Q LEGO® Builder

# BUILDER



Apple and the Apple logo are trademarks of Apple Inc., registered in the U.S. and other countries and regions. App Store is a service mark of Apple Inc. Google Play and the Google Play logo are trademarks of Google LLC. Tencent and the Tencent logo are trademarks of Tencent Inc.

Q [LEGO.com/devicecheck](https://www.lego.com/devicecheck)

**EN** Ask parents' permission before going online | **DE** Eltern um Erlaubnis bitten, bevor du online gehst | **FR** Demande l'autorisation d'un parent avant d'aller en ligne | **IT** Chiedi il permesso ai tuoi genitori prima di andare online | **ES** Pídeles permiso a tus papás antes de conectarte a Internet | **PT** Peça autorização aos pais antes de acederes online | **ZH** 上网前应先征得父母的同意 | **PL** Poproś rodziców o zgodę, zanim wejdiesz do Internetu | **CS** Než půjdeš na internet, požádej rodiče o svolení | **SK** Skôr než pôjdeš na internet, vypýtaj si povolenie od rodičov | **HU** Kérj szülői engedélyt, mielőtt online csatlakoznál! | **RO** Cere permisiunea părinților înainte de a te conecta online | **BG** Поискайте разрешение от родител, преди да влезете онлайн | **LV** Pirms došanās tiešsaistē palūdz atļauju vecākiem | **ET** Enne Interneti kasutamist küsi vanematelt luba | **LT** Prieš prisijungdami prie interneto, atsiklauskite tėvų

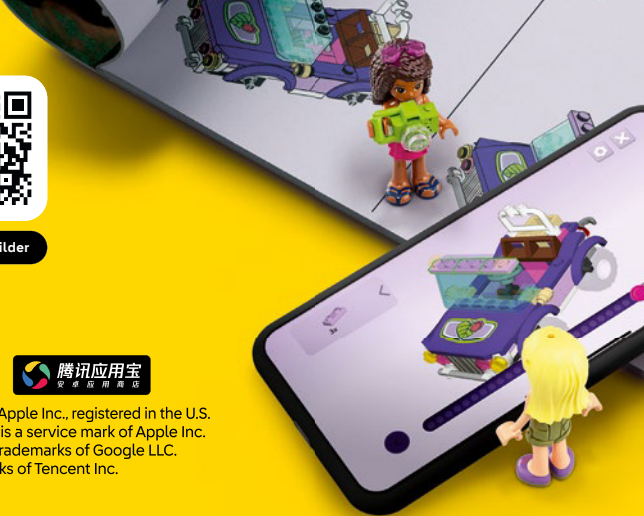



**EN** Build It Your Way | **DE** Bau, wie du willst | **FR** Construisez à votre façon | **IT** Costruiscilo come vuoi tu  
| **ES** Constrúyelo a tu manera | **PT** Constrói à Tua Maneira | **ZH** 自由拼搭 | **PL** Zbuduj po swojemu | **CS** Postavte to po  
svém | **SK** Postavte to po svojom | **HU** Építs kedved szerint! | **RO** Construięște așa cum dorești | **BG** Постройте го  
по своя начин | **LV** Būvē tieši tā, kā vēlies | **ET** Ehita enda moodi | **LT** Sukonstruokite savaip



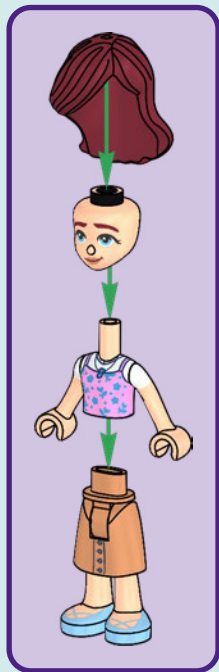

# PAISLEY



**WAFFLES**

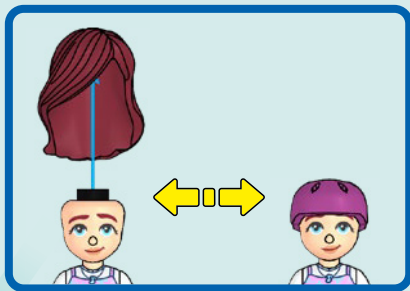



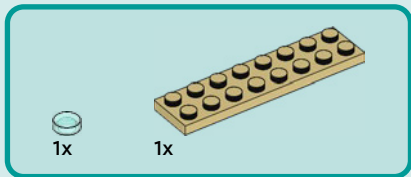

1

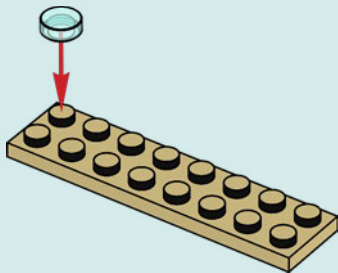



2x



1x

2

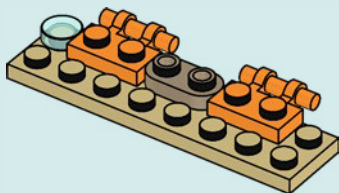

2x



1x

3

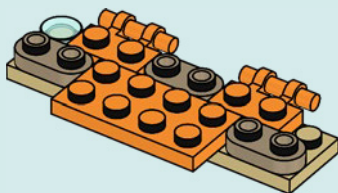



1x

4

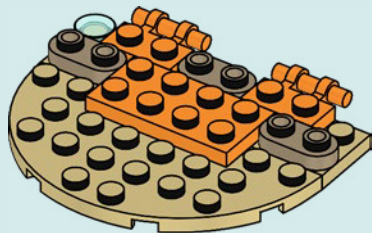

2x

5

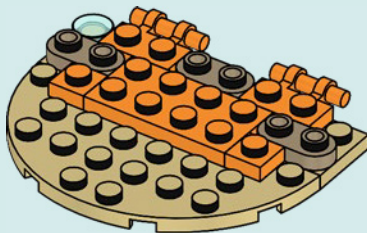



1x

6

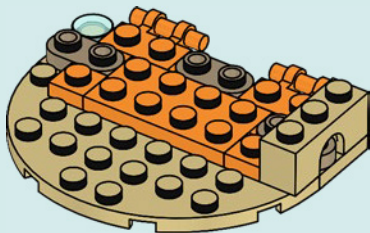

2x

7

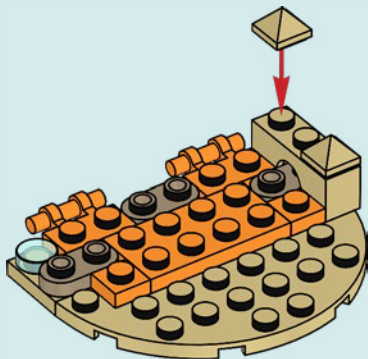



1x

8

1

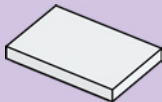

2

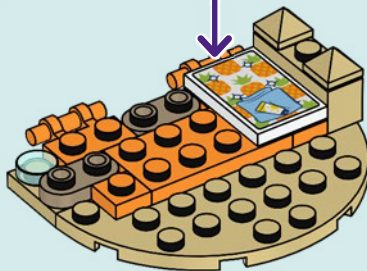



1x

9

1

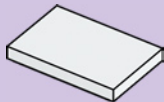

2

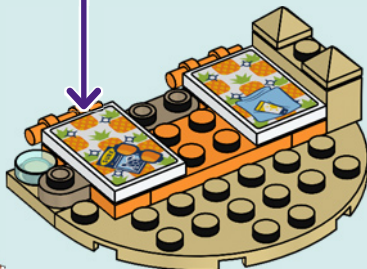



2x

10

1



2



2x

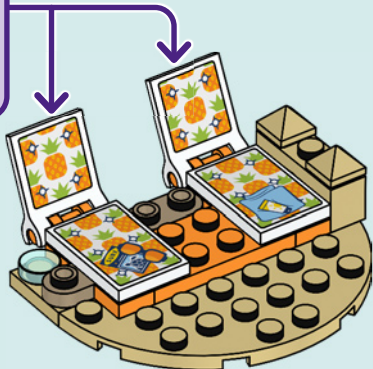



2x



2x

11



2x







1x



1x



1x

# 12

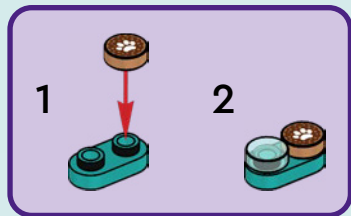



1x

13





1x



1x

14

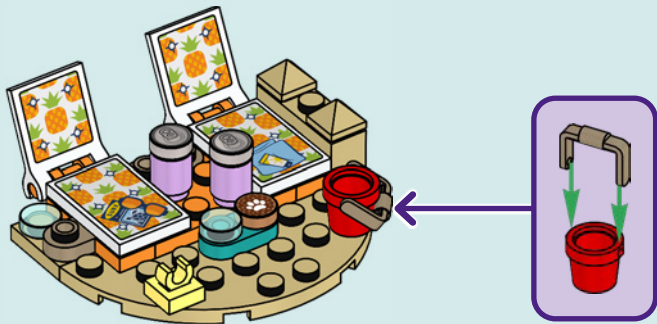



1x



1x

# 15



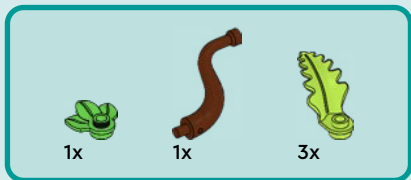

16

1

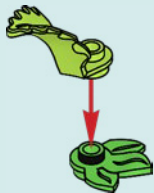

2



3

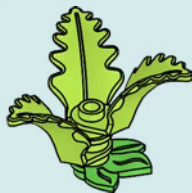

4

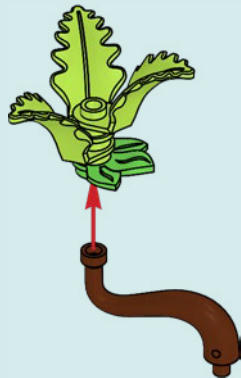









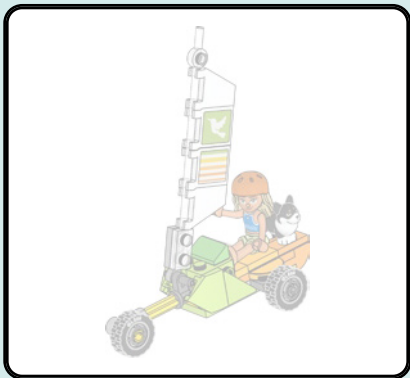

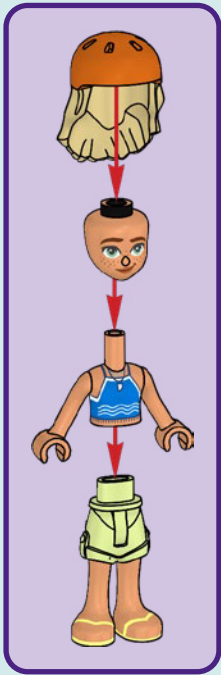

**SAGE**



**PEACHES**



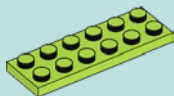

1x



1x

1

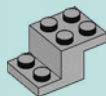
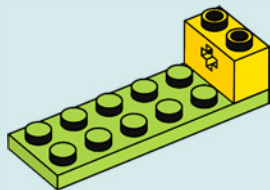

1x

2

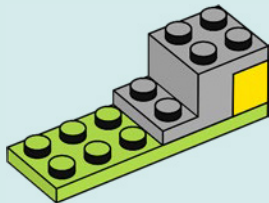



1x



1x

3

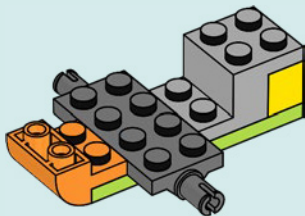



1x



2x

4

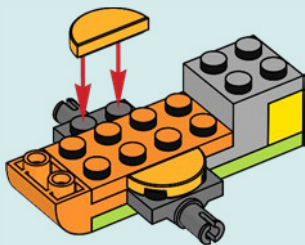

1x



2x



1x

5

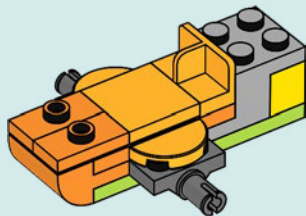



2x

6

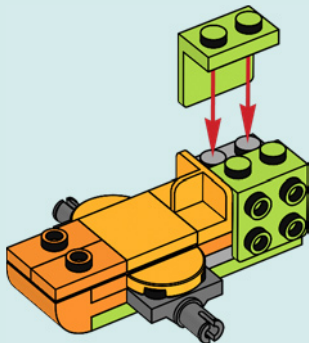



1x

7

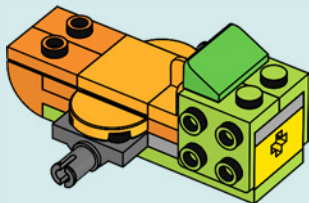

1x

8

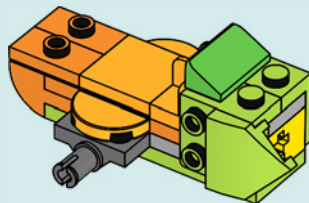



1x

9

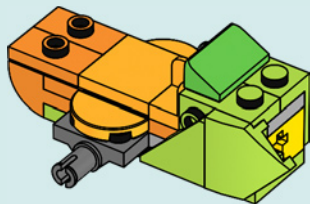





1x



1x

# 10

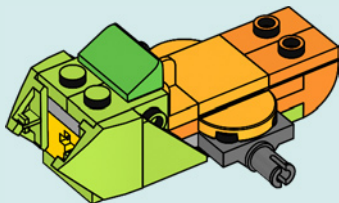

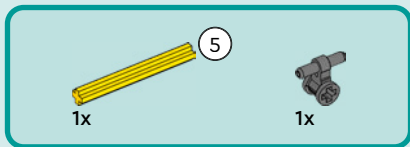

11

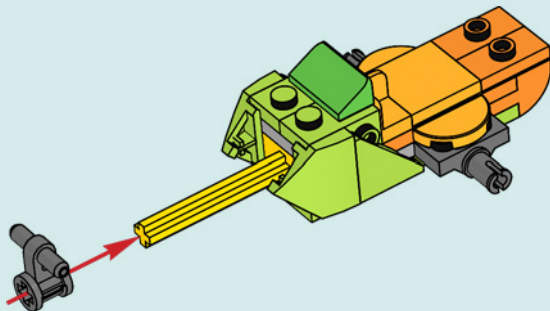



1x



1x



1x



1x

# 12

1

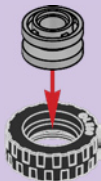

2

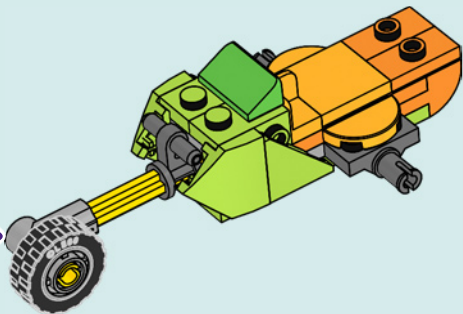
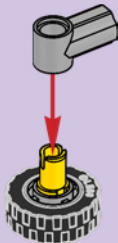

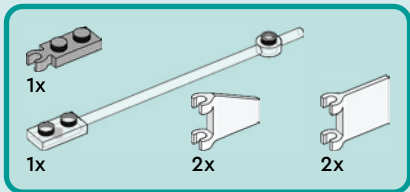
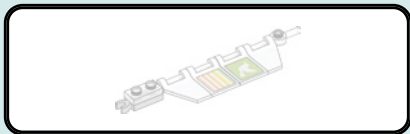

13

1

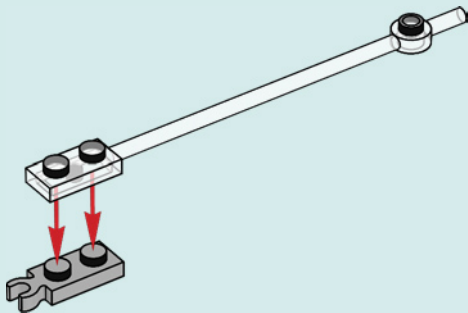

2

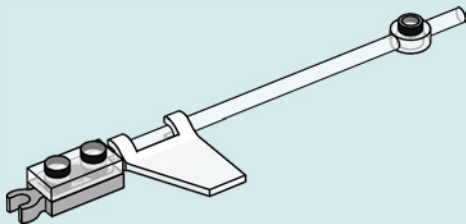

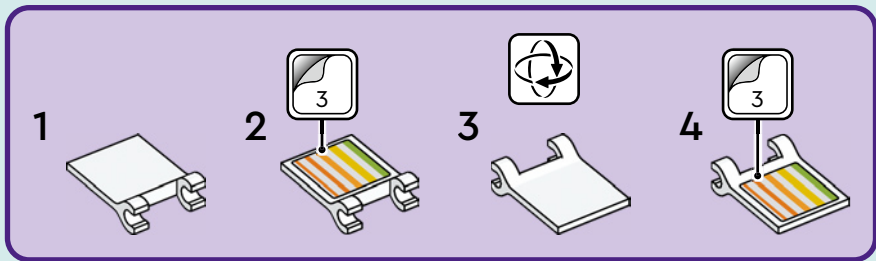

3

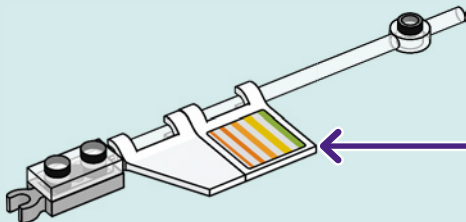

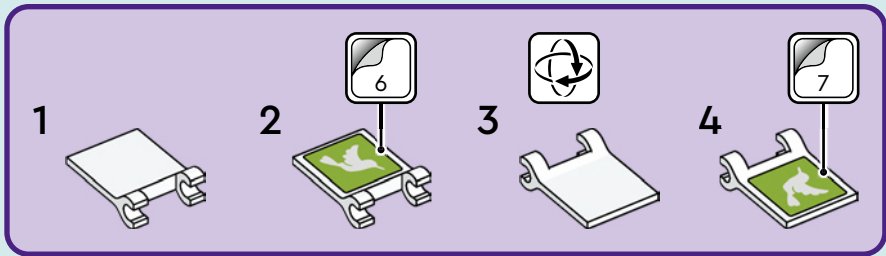

4

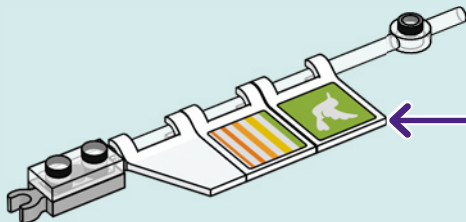

5

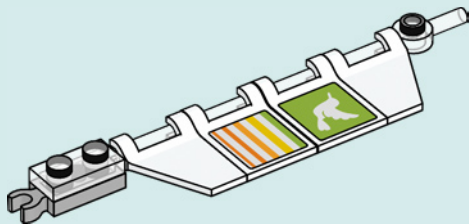



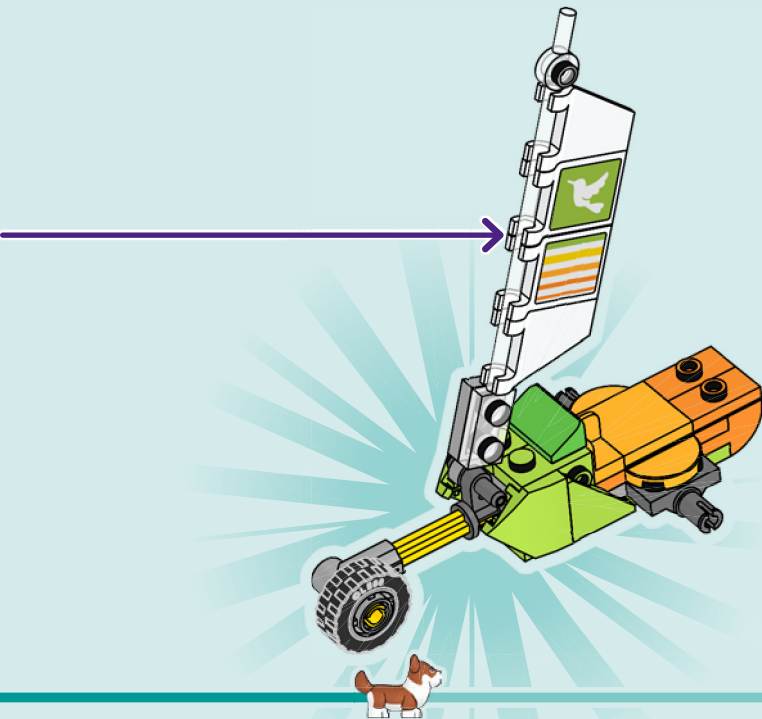



2x



2x

14



2x

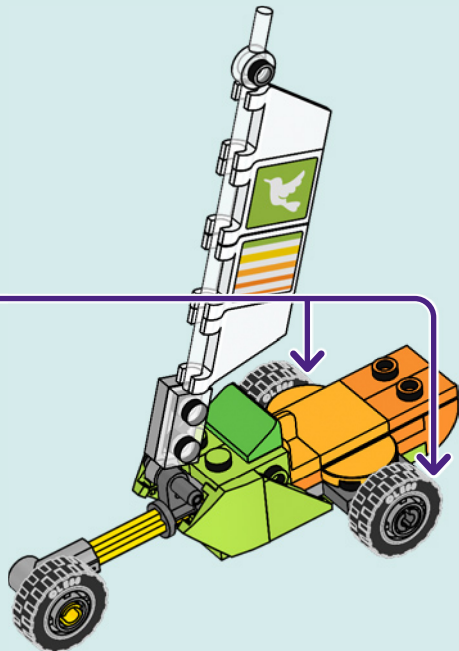





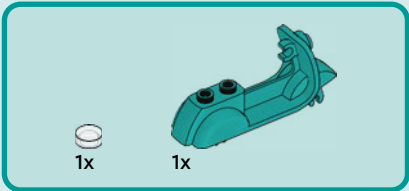
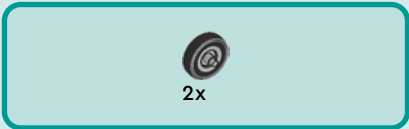

1

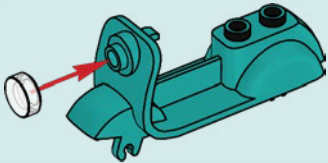

2

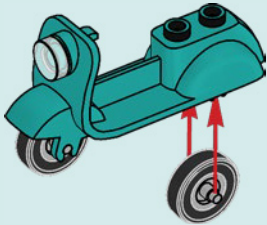

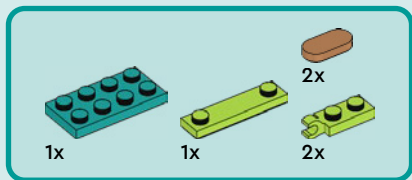

3

1

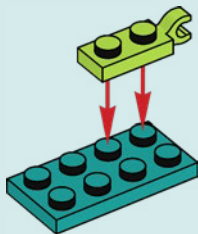

2

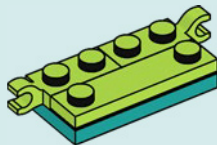

3

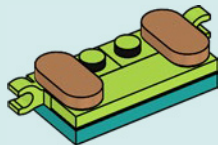

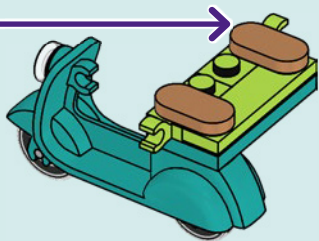

4

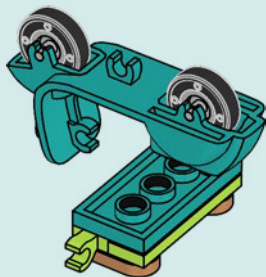



1x



1x

5

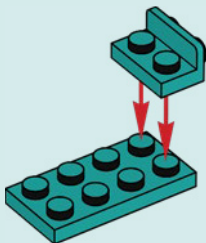

1x

6

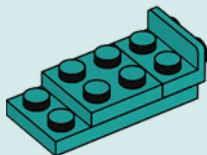





2x



1x

7

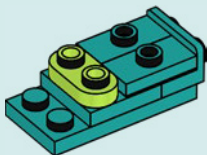

2x

8

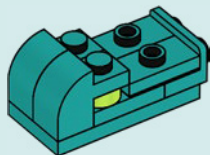



1x

9

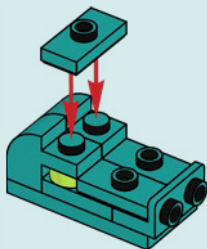

2x



1x

10

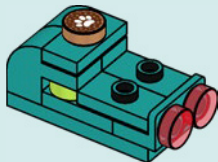

11

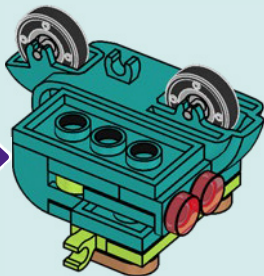



1x



1x

# 12

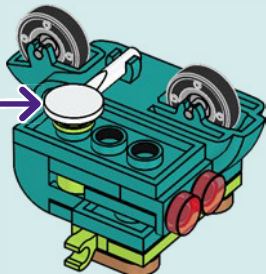
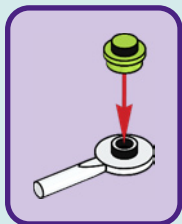



1x



1x

# 13

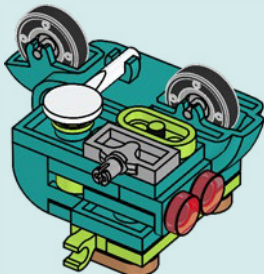

1x

# 14

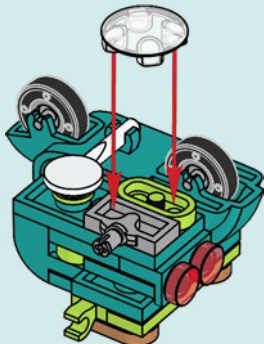



1x



1x

15

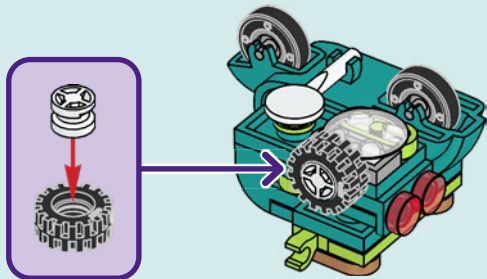



1x

16

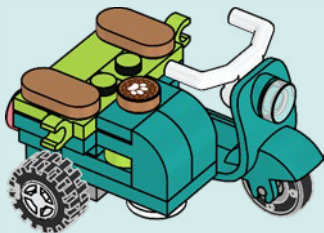

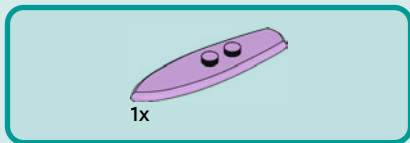

17

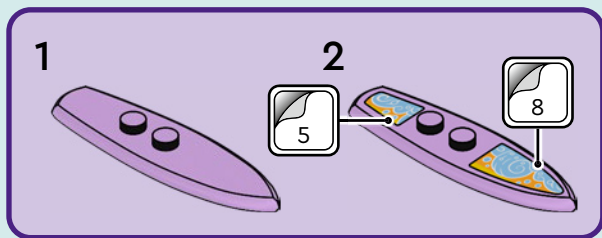



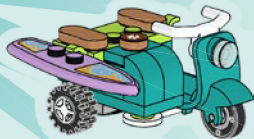



# Friends™

WATCH  
SERIES  
ONLINE



WATCH SERIES ONLINE / SCHAU DIR DIE SERIE ONLINE AN / REGARDE LA SÉRIE EN LIGNE /  
GUARDA LA SERIE ONLINE / MIRA LA SERIE EN INTERNET / ASSISTIR À SÉRIE ONLINE / 在线观看 /  
OGLAĐAJ SERIAL W INTERNECIE / SLEDUJ SERIÁL ONLINE / POZRI SI SERIÁL ONLINE / NÉZD A  
SORÓZATOT ONLINE / VIZIONEAZĂ SERIALUL ONLINE / ГЛЕДАЙТЕ СЕРИАЛА ОНЛАЙН / SKATIES  
SERIĀLU TIEŠSAISTĒ / VAATA SARJA VEEBIST / ŽIŪRĒK SERIĀLAĻ INTERNETU





# Friends™

42663



42650



42649



42652





# Friends™



NOVA

OLLY

ALIYA

PAISLEY

LIANN

LEO

AUTUMN

ZAG



Rebuild  
the  
World™ 



1x  
390001



1x  
6194809



1x  
6360202



2x  
6365500



4x  
6365487



1x  
6517953



1x  
6517951

62



1x  
6364621



2x  
6156667



2x  
6249125



1x  
6522369



1x  
4618651



1x  
6123812

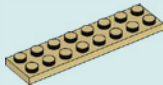

1x  
4113988



1x  
6481602



1x  
6522122



1x  
6003001



1x  
6331822



1x  
6206240



1x  
6130008



2x  
6285598



1x  
4578677



3x  
4617848



1x  
6182261



1x  
6138510



1x  
6514191



1x  
6163901



2x  
6514192



1x  
6245275



3x  
6231386



1x  
6276993



2x  
4524929



2x  
6092599



2x  
4190164



1x  
6442089



2x  
4158355



1x  
6523800



2x  
6514189



1x  
6482693



3x  
6210399



2x  
6399564



1x  
6373576



1x  
6249390



2x  
6338181

5

1x  
4183133

2x  
6264062

3x  
6438450

2x  
6442920

2x  
6212972

2x  
6247209

2x  
6347285

1x  
6257597

1x  
4621548

1x  
6138657

1x  
6382326

1x  
6409769

2x  
6513772

1x  
6133805

1x  
6020147

1x  
6296859

3x  
4211758

1x  
6395349

1x  
6354568

1x  
6347992

2x  
6209673

1x  
6516594

1x  
6228091

2x  
6322904

1x  
6416490

1x  
6522140

1x  
6522132

1x  
6348060

1x  
6265669

1x  
6351293

2x  
6287856

2x  
6507790

1x  
6442279

 [LEGO.com/service](https://www.LEGO.com/service)



YOU COULD

WIN



Scan this QR code or go to  
**LEGO.COM/PRODUCTFEEDBACK** and give us  
your short feedback about this LEGO® set  
for a chance to win a cool LEGO prize.

Terms and Conditions apply\*

**EN: YOU COULD WIN.** Terms and Conditions apply\* **DE: Du könntest GEWINNEN.** Es gelten die Teilnahmebedingungen\* **FR: Tu pourrais GAGNER.** Des conditions s'appliquent\* **IT: Potresti VINCERE tu.** Termini e condizioni sono applicabili\* **ES: Puedes GANAR.** Aplican términos y condiciones\* **PT: Poderá GANHAR.** Aplicam-se termos e condições\* **ZH: 轻松获奖. 条款和条件适用\*** **PL: Szansa na WYGRANĄ.** Obowiązują warunki korzystania\* **CS: Máte šanci VYHRÁT.** Platí všeobecné smluvní podmínky\* **SK: Máte šancu VYHRÁT.** Platia všeobecné zmluvné podmienky\* **HU: TE IS NYERHETSZ.** Felhasználási feltételek érvényesek\* **RO: Ai putea CÂȘTIGA.** Se aplică termenii și condiții\* **BG: Можете да СПЕЧЕЛИТЕ.** Има определени правила и условия\* **LV: Tu vari LAIMĒT.** Ir spēkā noteikumi un nosacījumi.\* **ET: Sul on võimalus VÕITA.** Kehtivad tingimused\* **LT: Jūs galite LAIMĖTI.** Taikomos sąlygos\*

\*[LEGO.com/productfeedback-terms](https://www.lego.com/productfeedback-terms)

LEGO, the LEGO logo and the Friends logo are trademarks of the LEGO Group.  
©2025 The LEGO Group.

6554524