



LEGO duplo™

10428



Booklet available in English
Heft in deutscher Sprache erhältlich
Livret disponible en français
Libretto disponibile in italiano

Folleto disponibile en español
Folheto disponível em Português
如需中文版手册
Broszura w języku polskim

Brožura je k dispozici v češtině
Brožúra je k dispozícii v slovenčine
Útmutató elérhető magyarul
Broșură disponibilă în limba română

Buklets latviešu valodā ir pieejams
Brošūūr on saadaval Eesti keeles
Buketlas lietuvių kalba prieinamas

LEGO.com/service/buildinginstructions



LEGO.com/sustainable-packaging



FR
DONNEZ
OU
RECYCLEZ



ASSOCIATION

OU



MAGASIN

OU



DÉCHÈTERIE

Adresses sur quefairedemesdechets.fr

Building the Big Skills Toddlers Need

We believe in big starts. Our big bricks are designed for little hands to master. When toddlers' creativity is set free, their opportunities to learn become endless. We call it Learning Through Play. And it inspires every LEGO® DUPLO® set. Based on thorough scientific research, each set helps young minds develop both IQ skills (cognitive, physical, creative) and EQ skills (social, emotional). Let all toddlers Start Off Big.

LEGO DUPLO sets are categorised into benefit territories that match toddlers' ages and developmental stages



**PLAY
IDEAS**

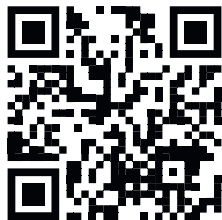

**CREATIVE
SOLUTIONS**



**LEARN
PATIENCE**

LEGO® DUPLO® sets in this territory involve playful challenges that can help toddlers master a range of skills, including hand-eye coordination and how to focus, manage emotions and solve problems. When you allow toddlers to play independently, and offer guidance from a distance, you can help them develop perseverance and learn to ask for help when needed.

































1

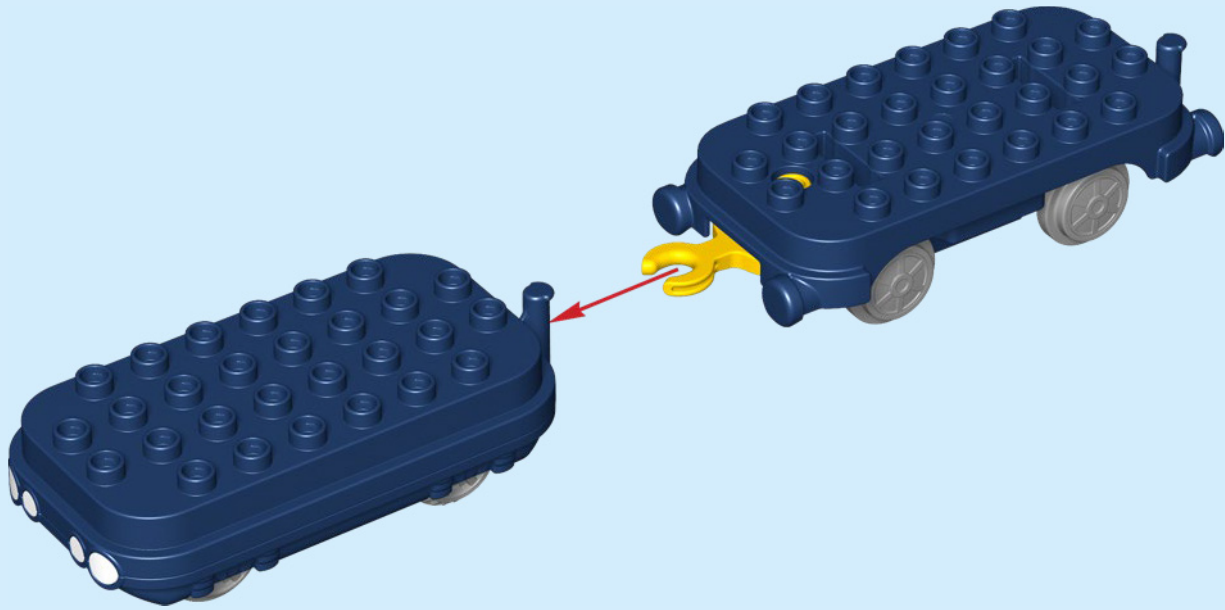

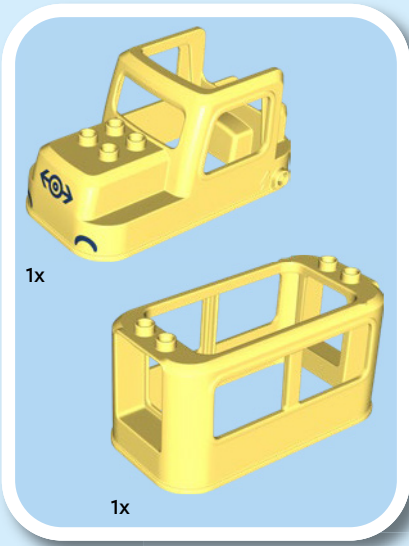

2



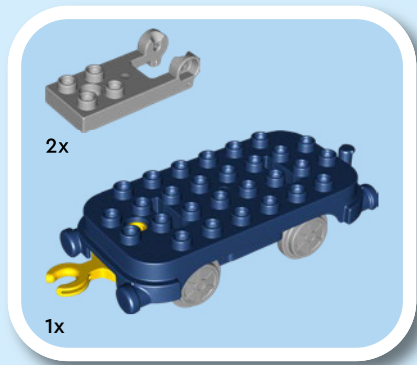

3

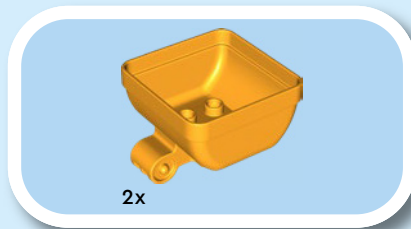
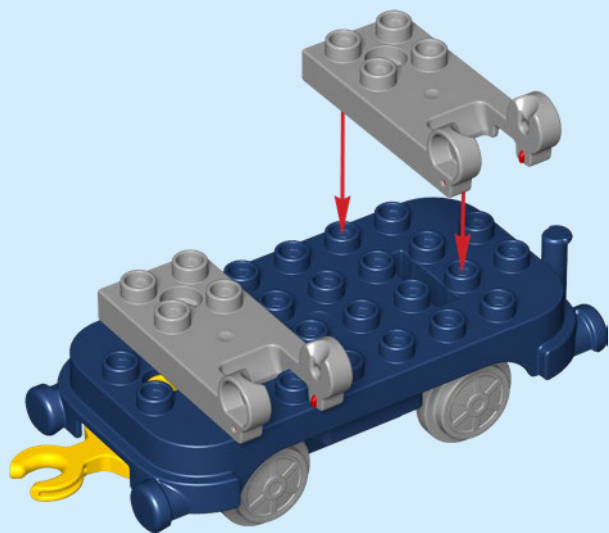

4

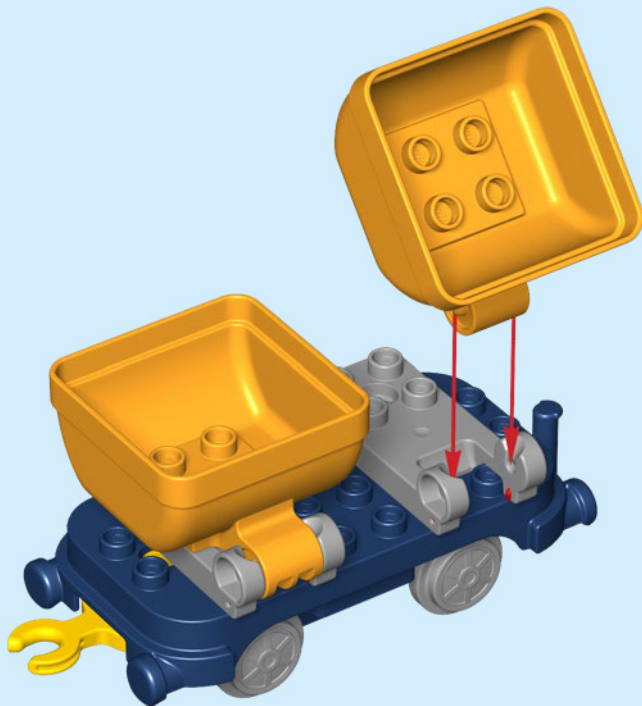

5

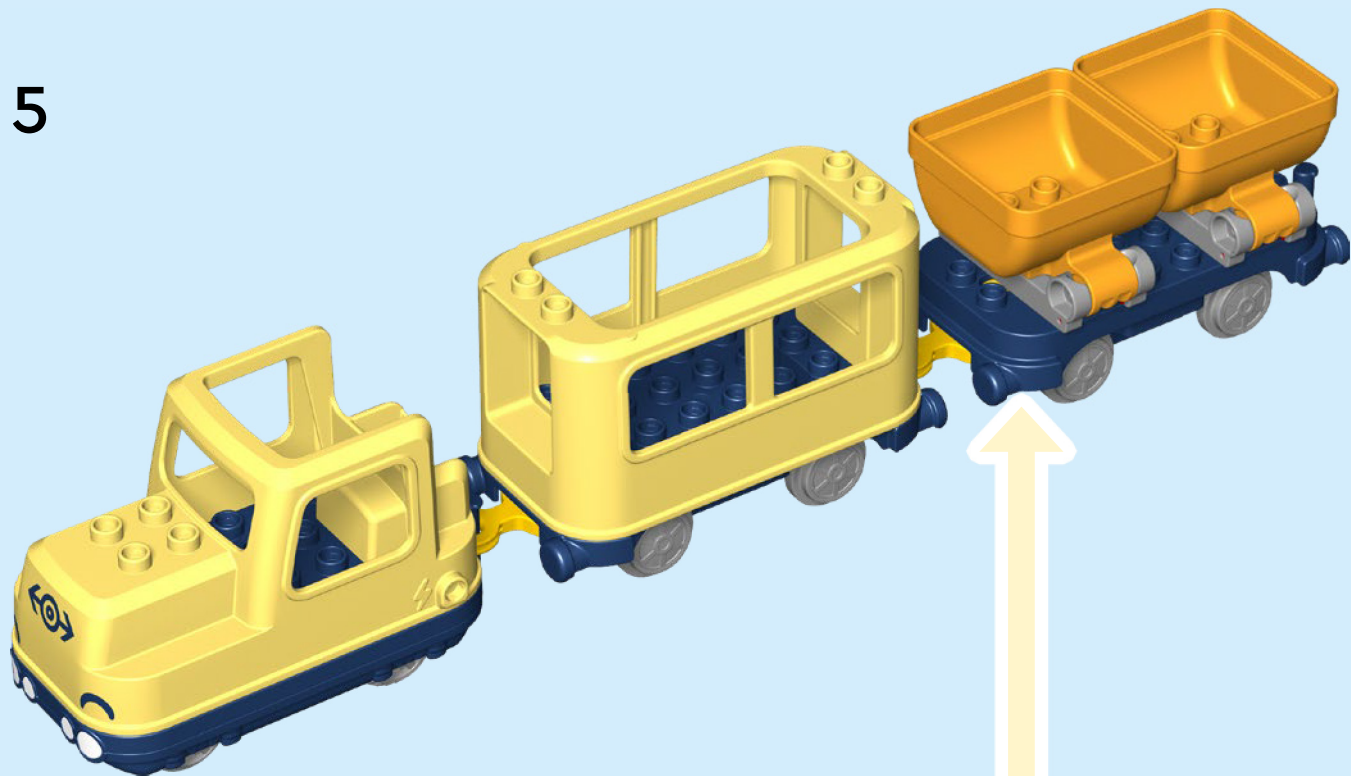

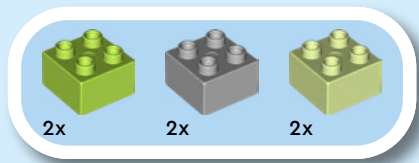

6



1



2



3

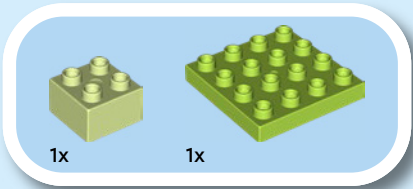

1

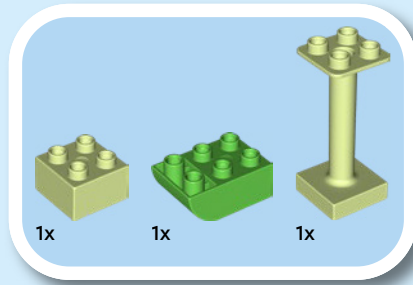
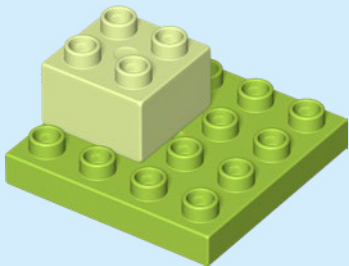

2

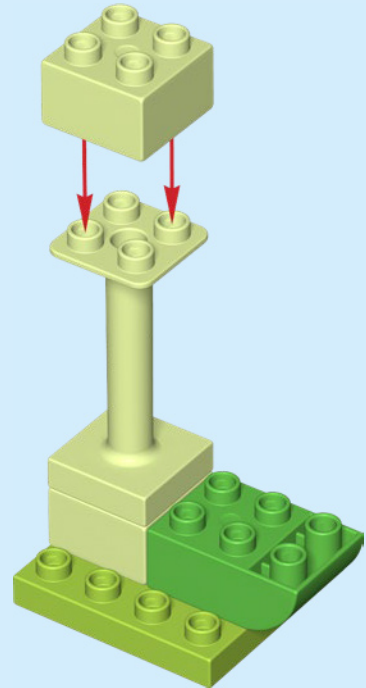

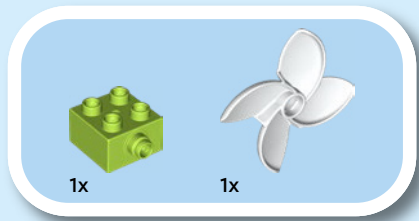

3

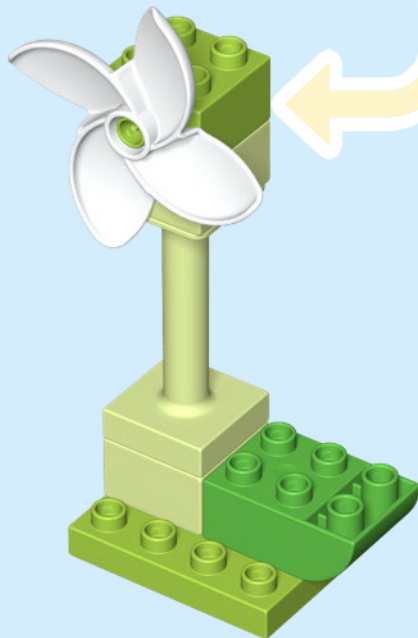
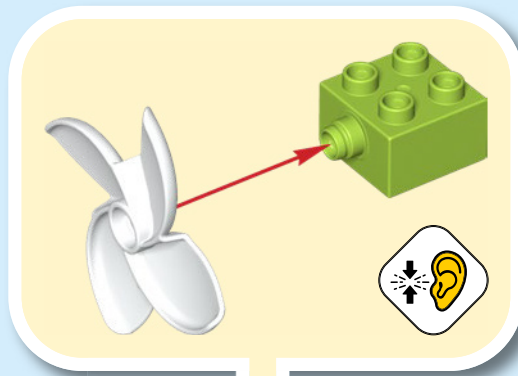



4



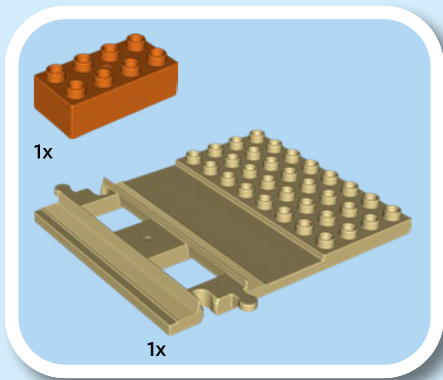

1

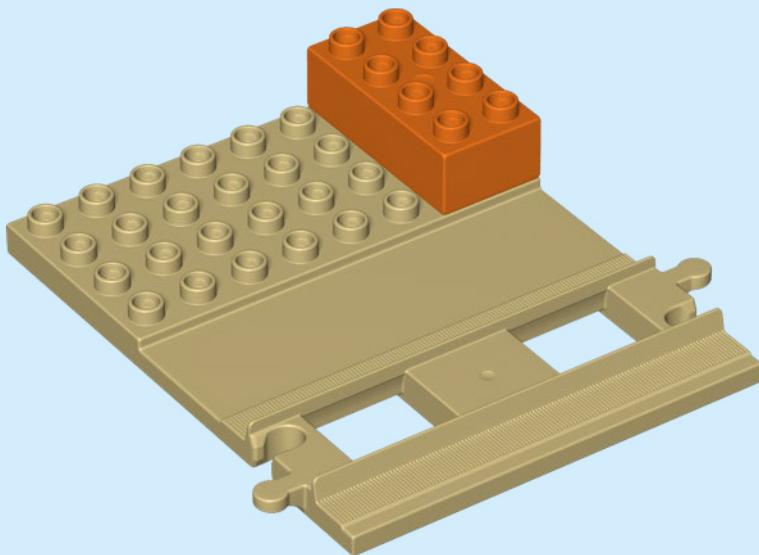

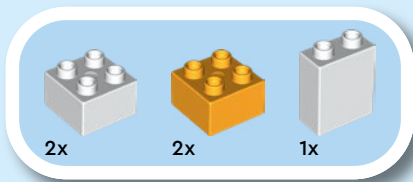

2

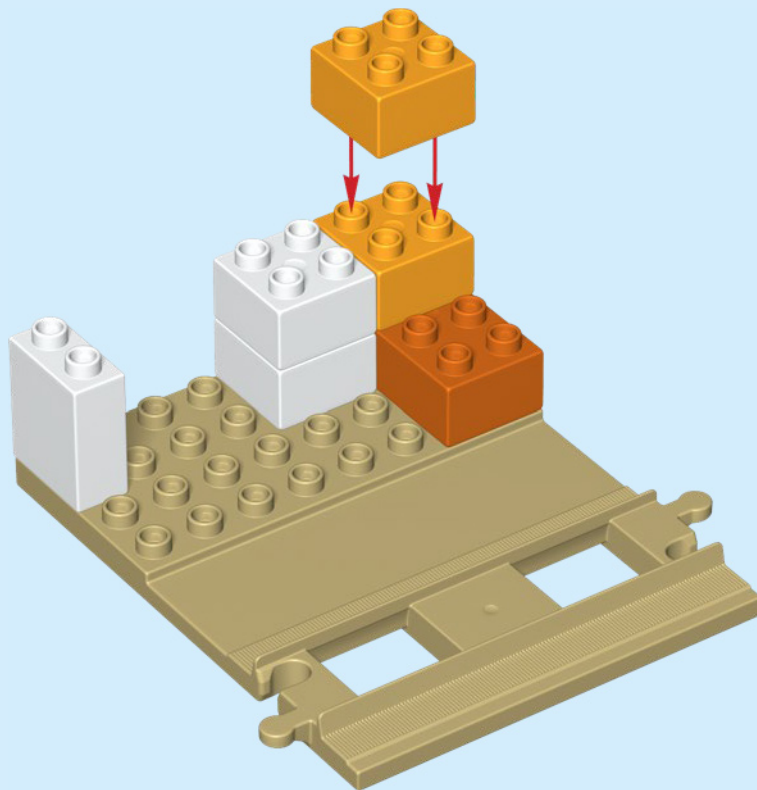

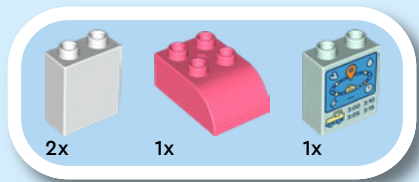

3

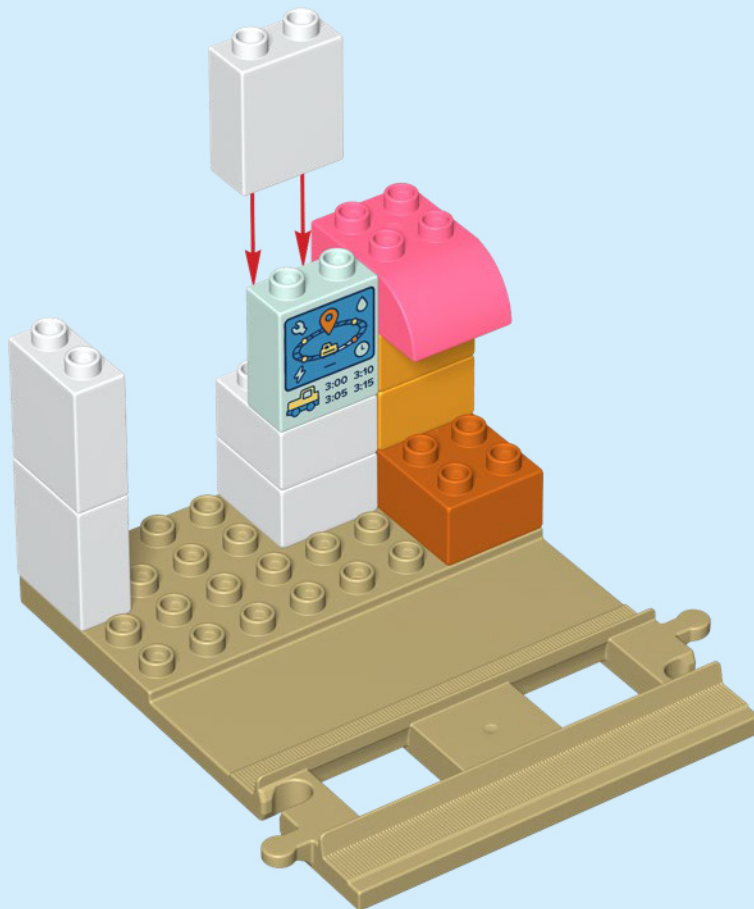

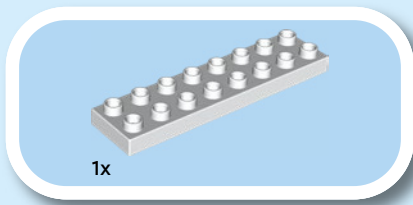

4

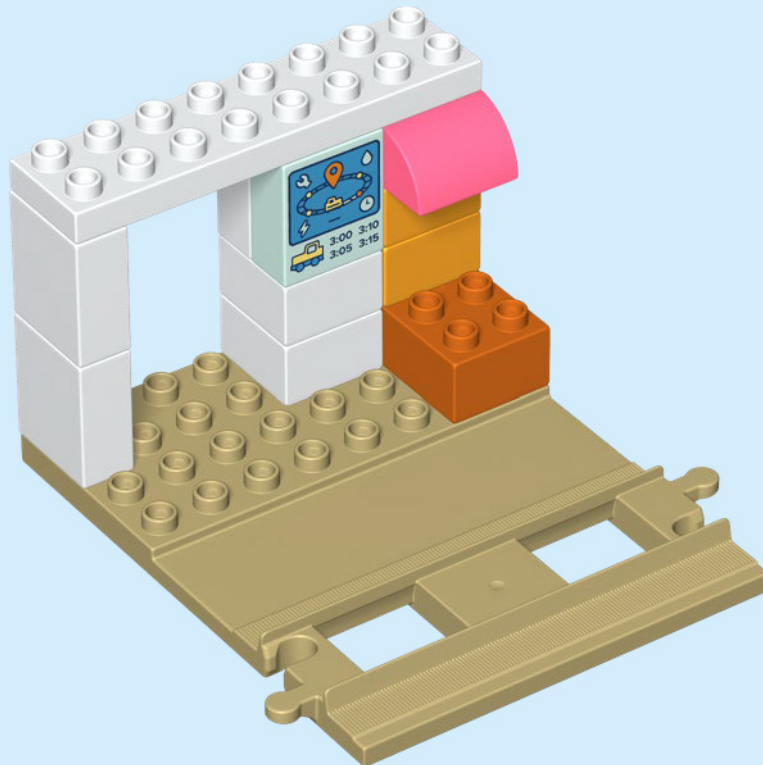

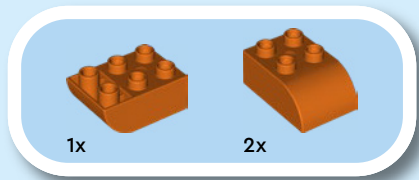

5

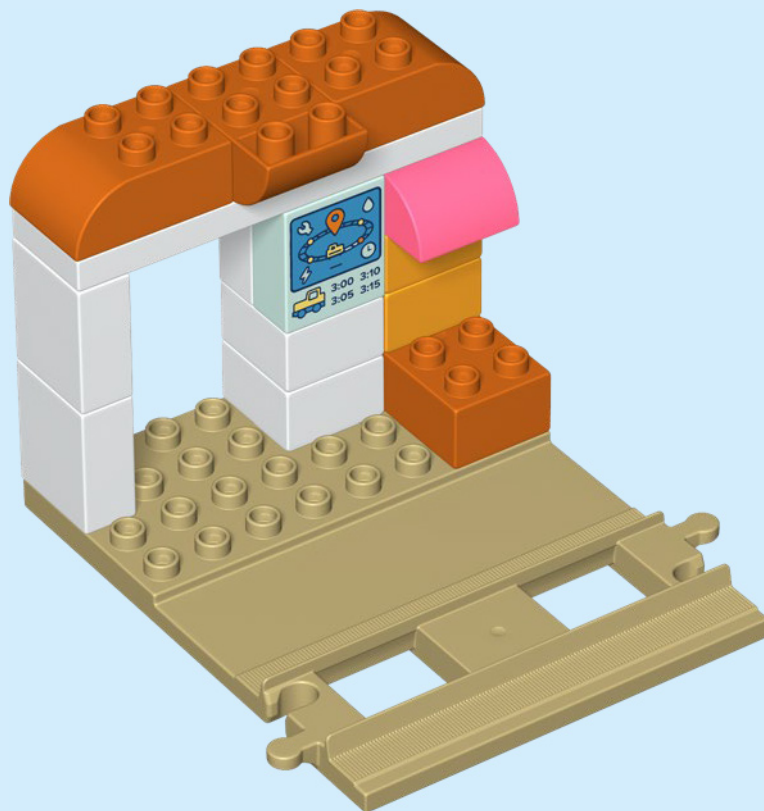

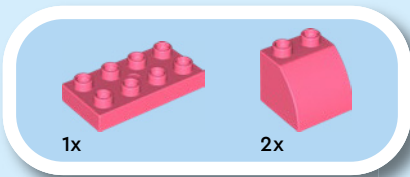

6

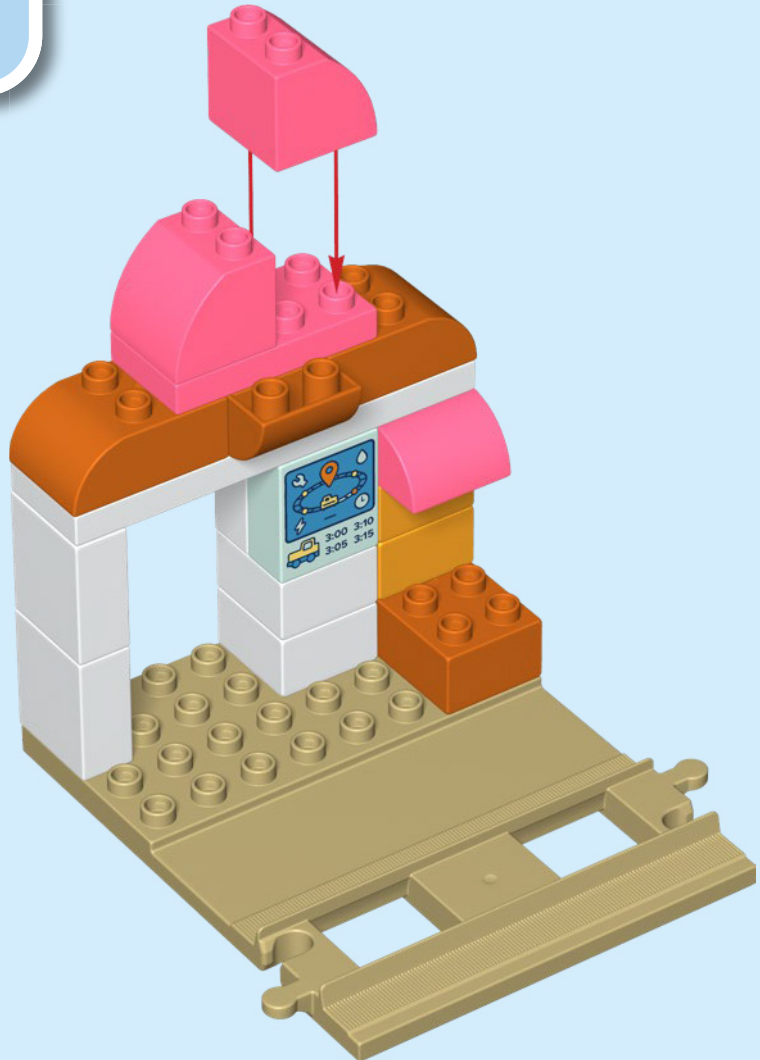

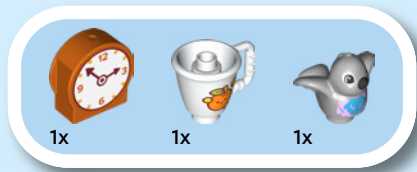

7

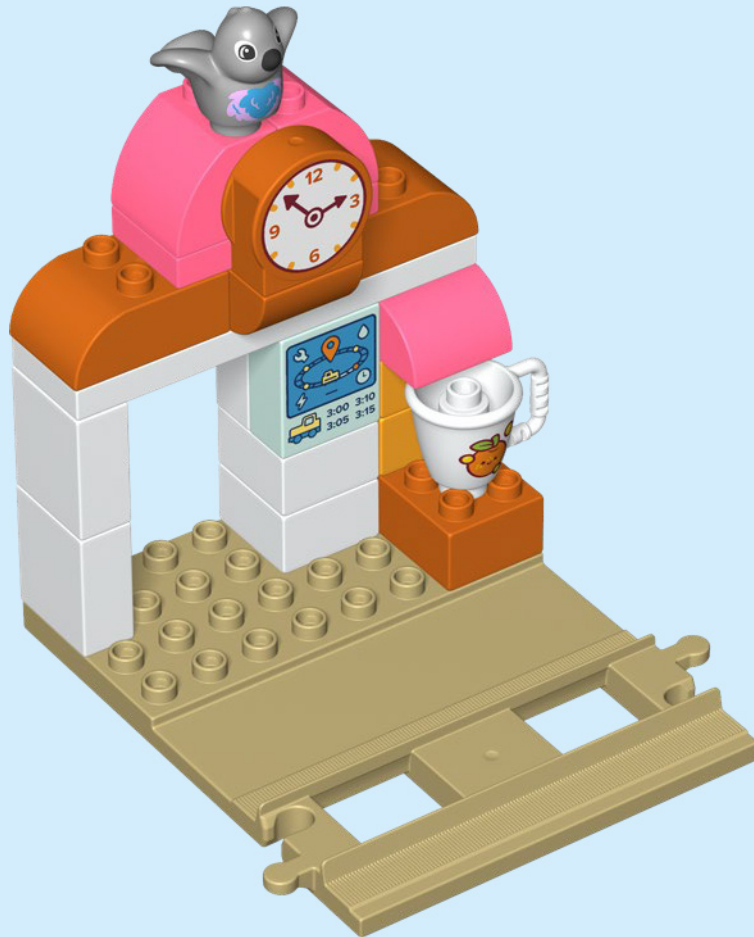

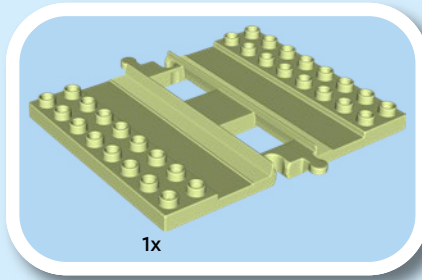
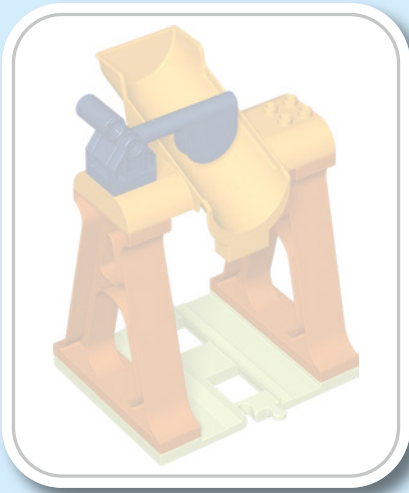

1

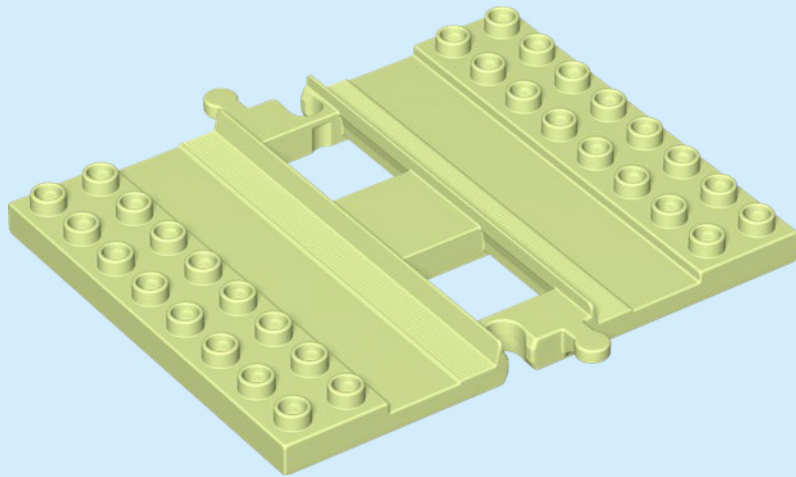

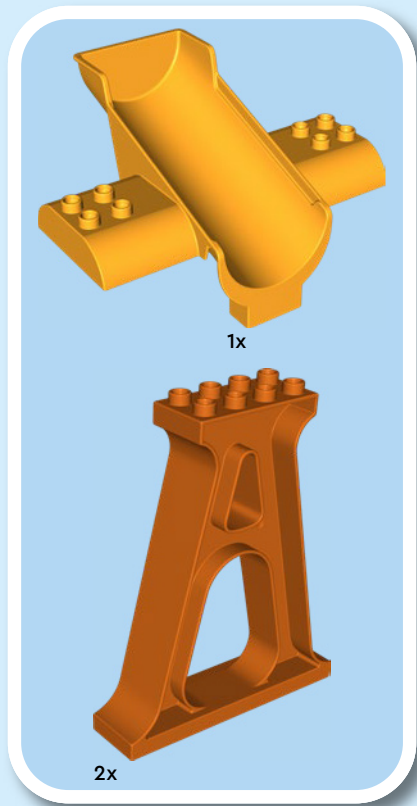

2

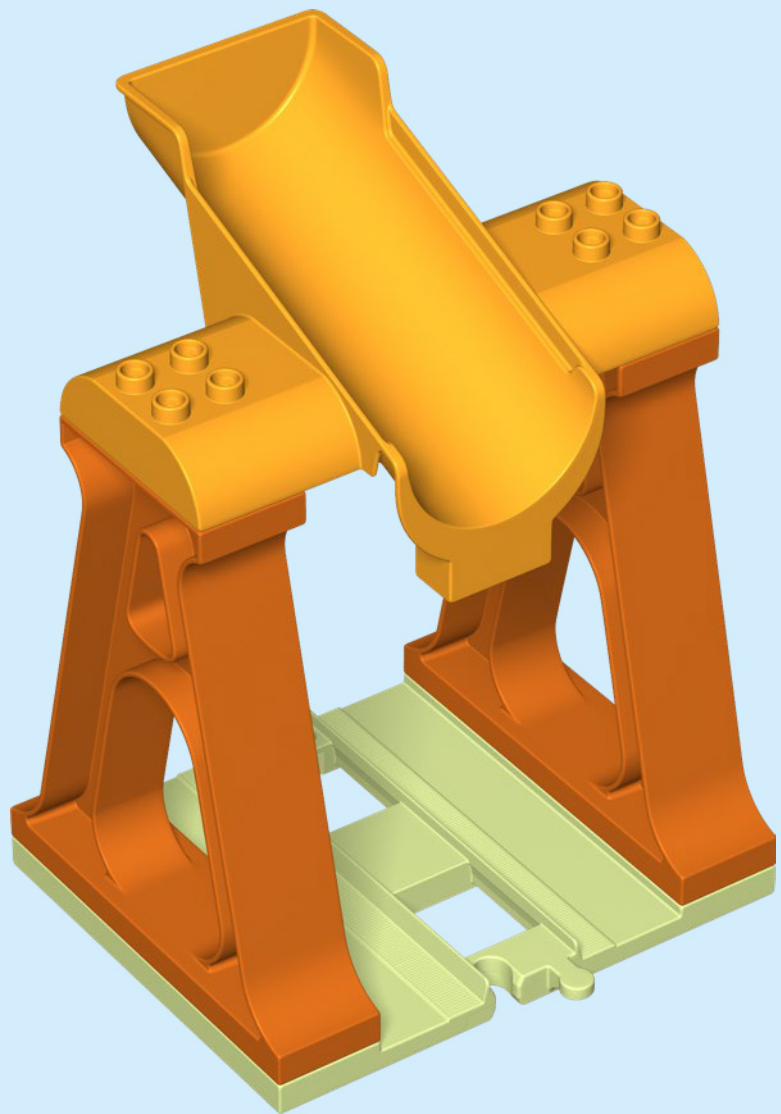

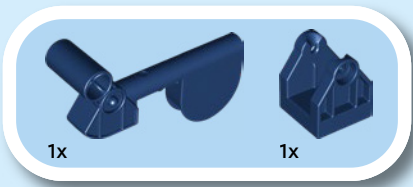

3

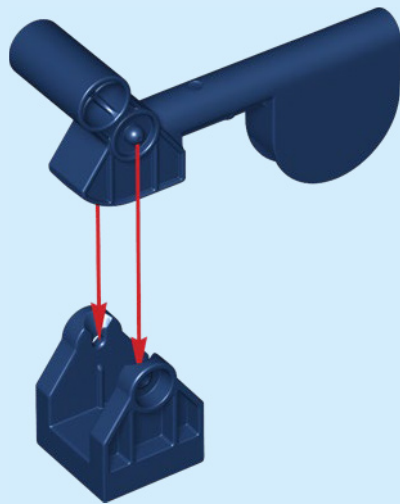

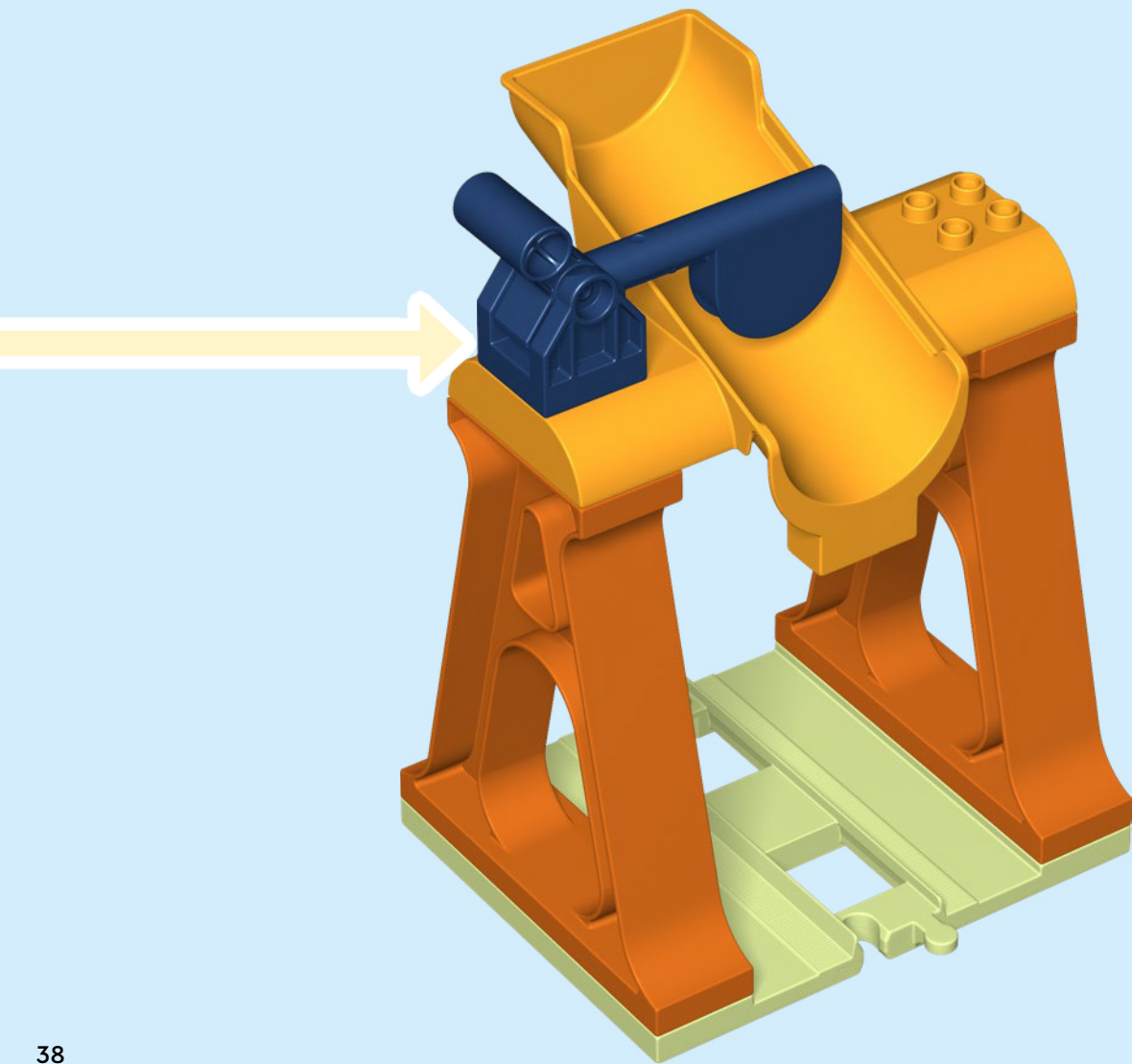

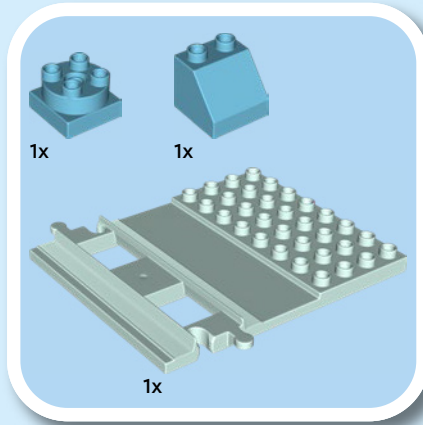

1

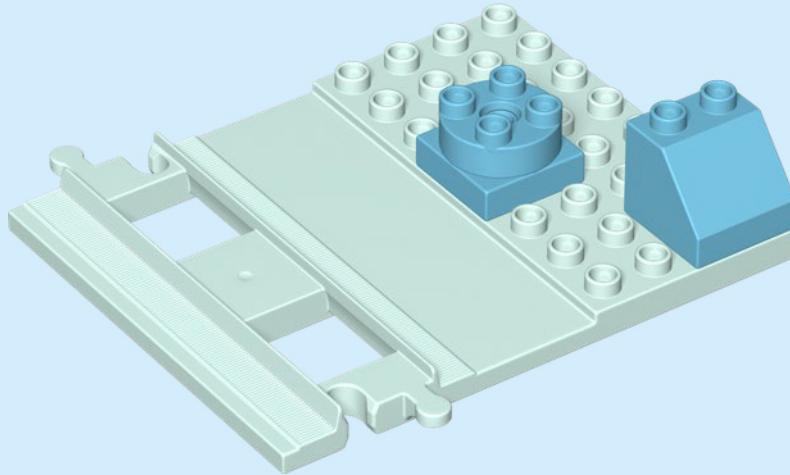

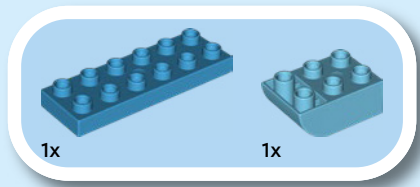

2

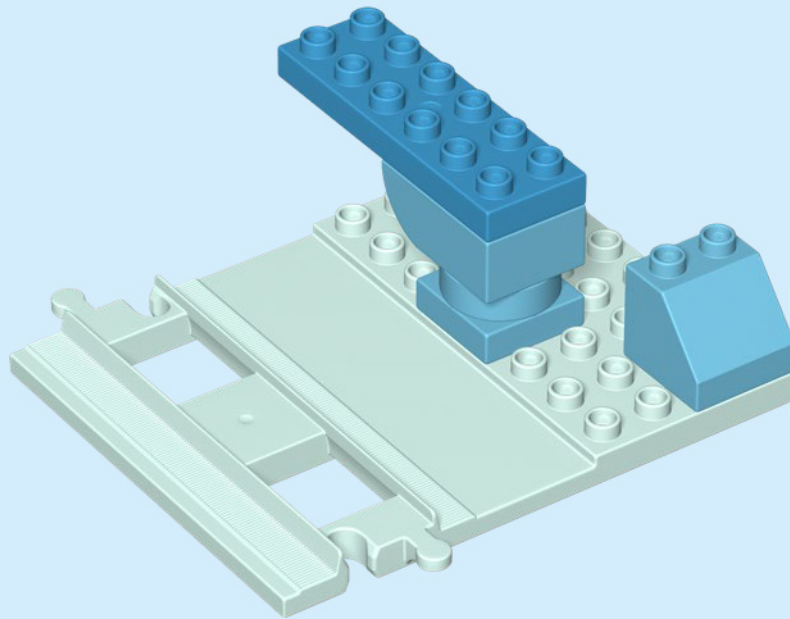

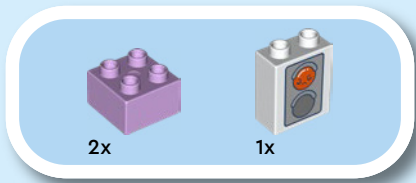

3

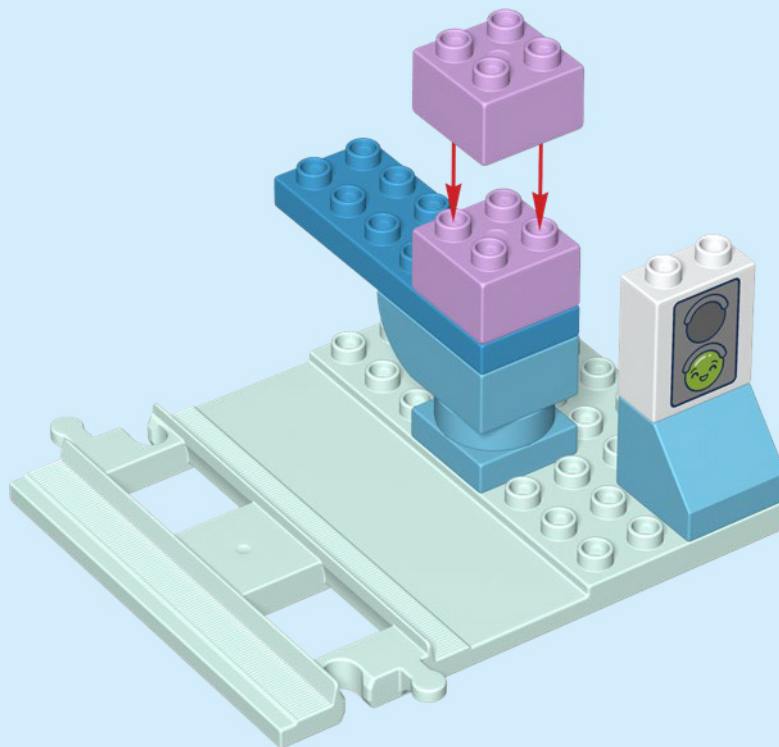

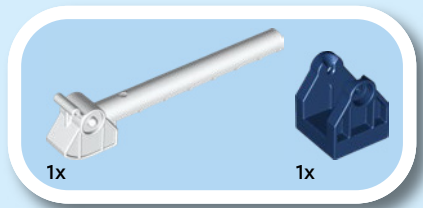

4

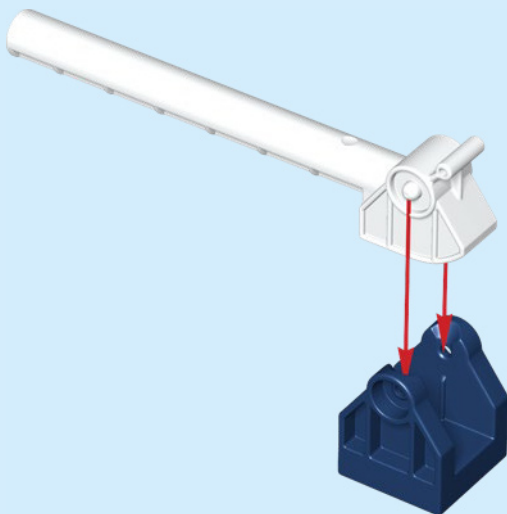

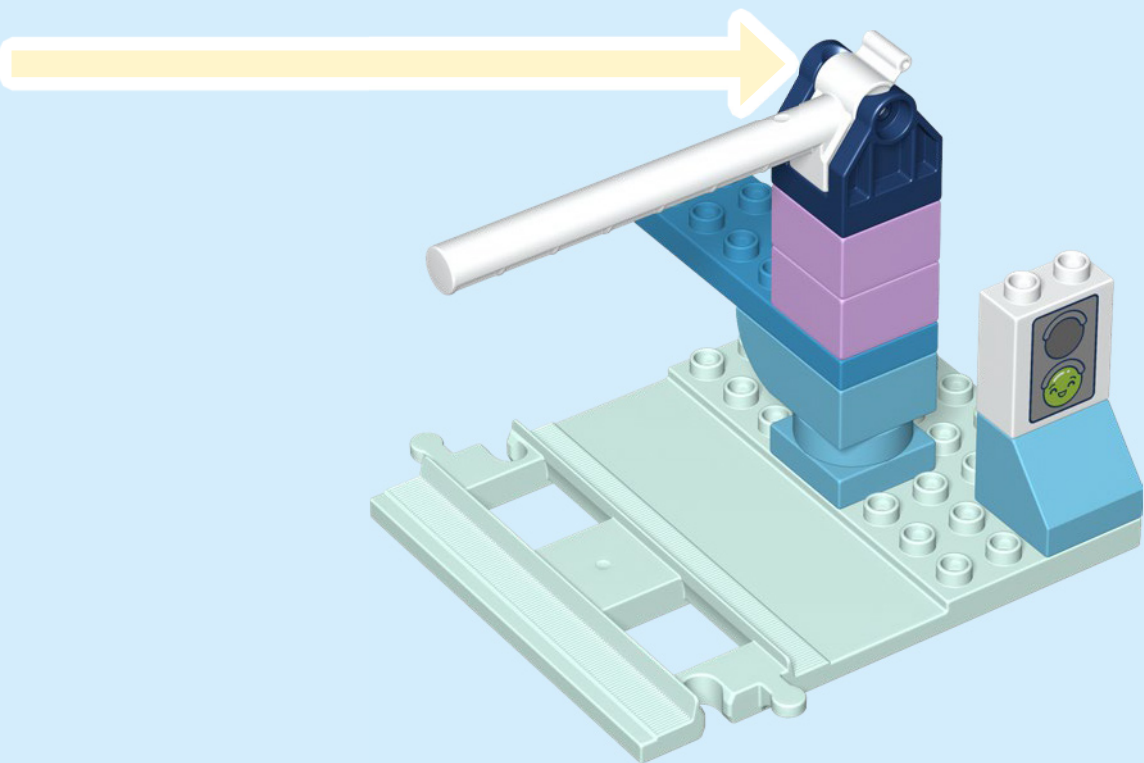

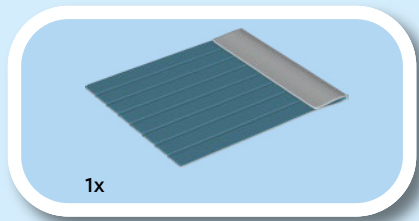

5

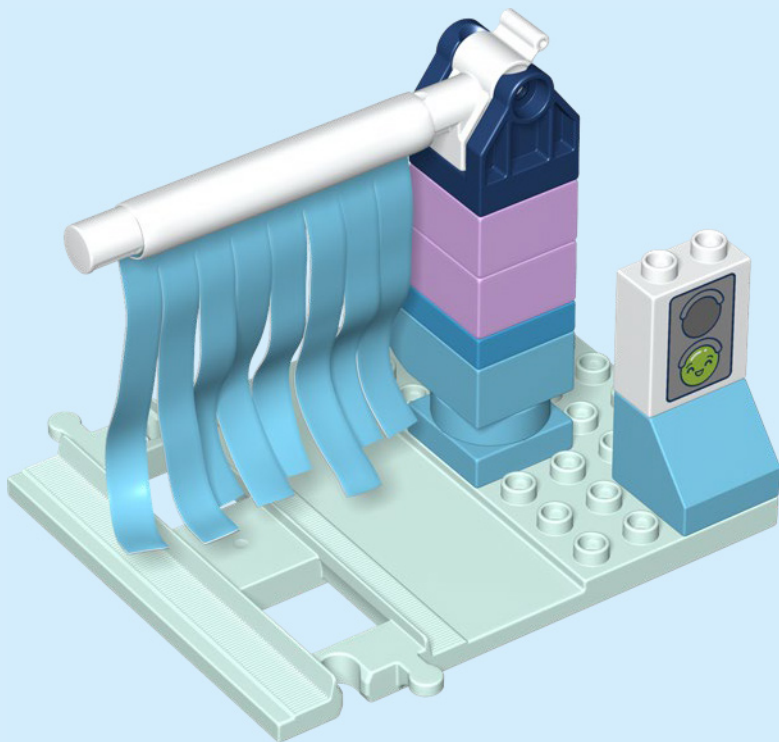

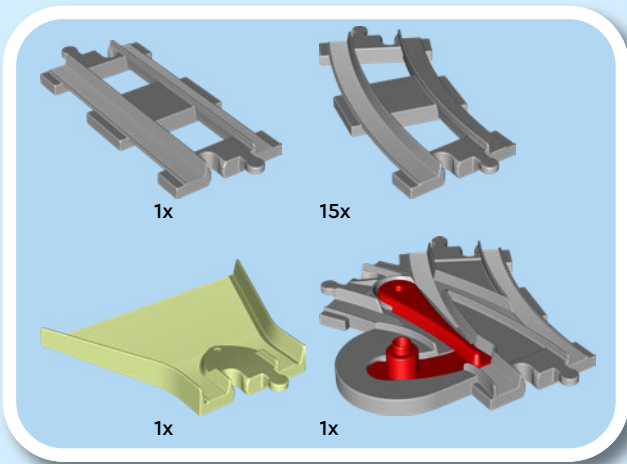

6

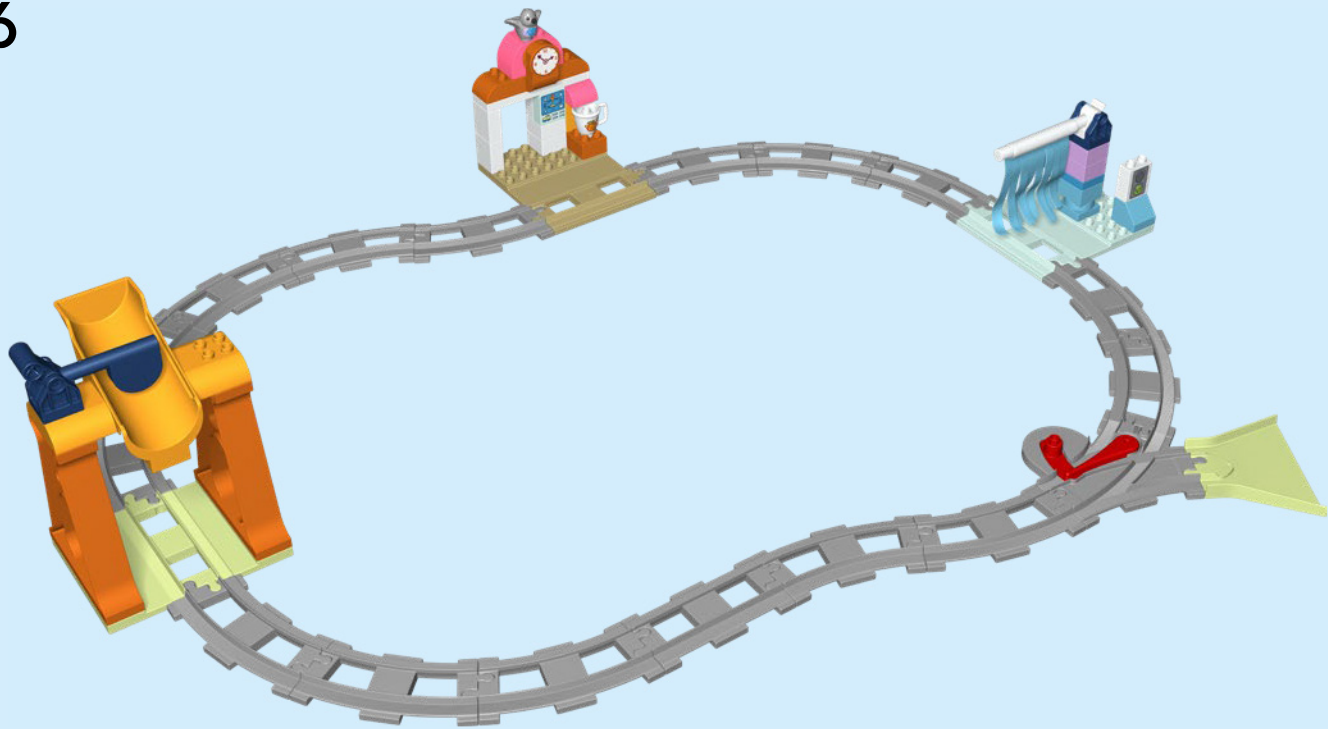

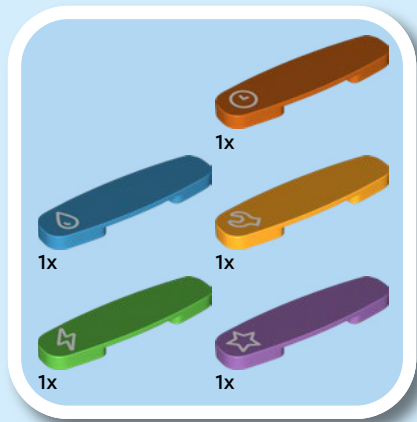

7

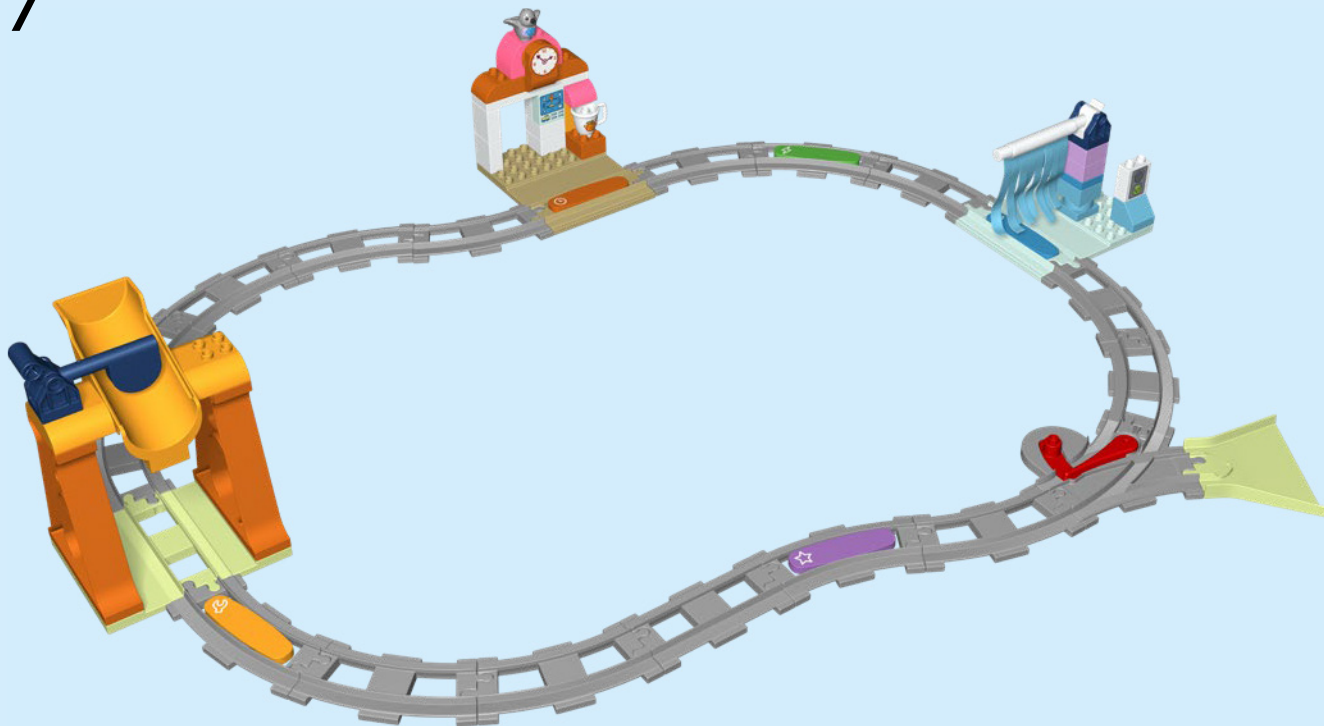

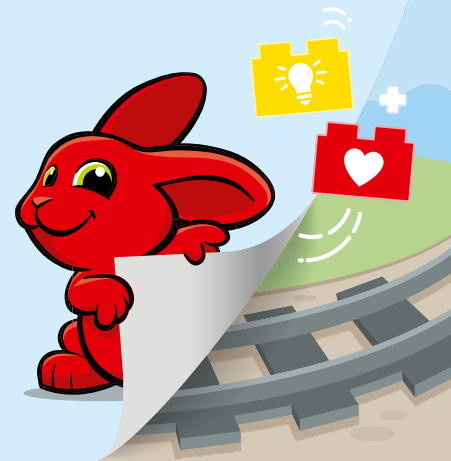
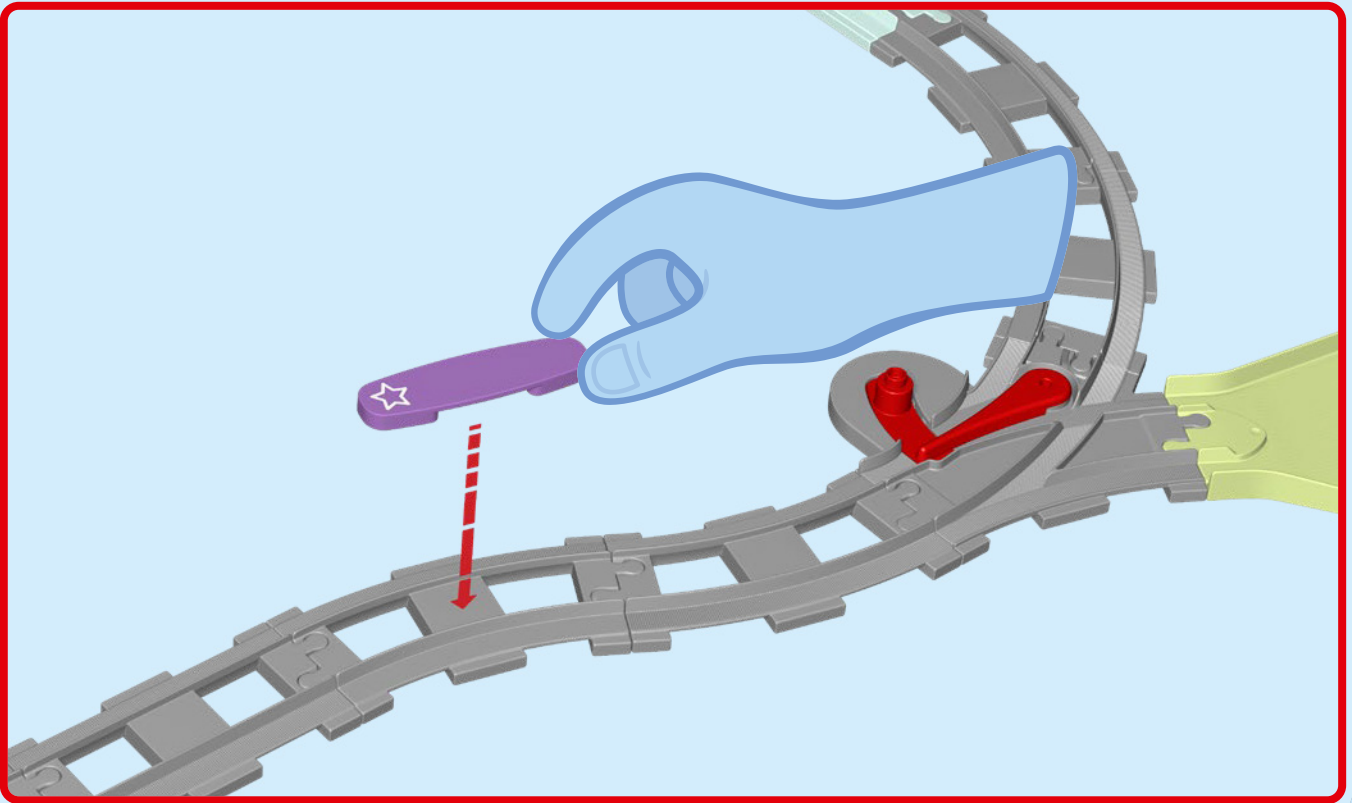

EXTEND PLAY WITH THE FREE APP

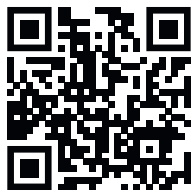

Apple and the Apple logo are trademarks of Apple Inc., registered in the U.S. and other countries and regions. App Store is a service mark of Apple Inc. Google Play and the Google Play logo are trademarks of Google LLC. Tencent and the Tencent logo are trademarks of Tencent Inc.

Q [LEGO.com/devicecheck](https://www.lego.com/devicecheck)





Extend play

Have hours of fun together with the new LEGO® DUPLO® Interactive Train set! Find even more Learning Through Play ideas that support the developmental needs of kids aged 2 and over.



Customise

Program and activate lots of inspirational sound effects in the special Action Brick. Find a playful song to go with your train adventures or record your own short sound effects together.



Control

The Remote-Control function puts your young train conductor right in the driver's seat. With intuitive commands, you can sound the train horn, control the lights, and drive the train back and forth. Enjoy the journey!





10425



10426



10427



10428

4x 1.5V LR 03 (AAA)
1:1

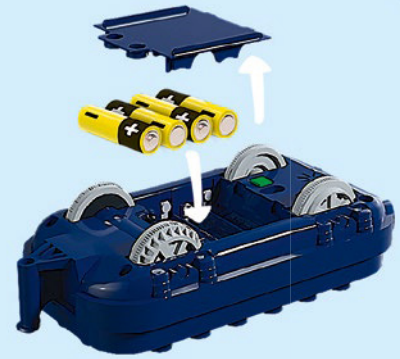



1x
6442943



1x
6463924



1x
6226885



1x
6478079

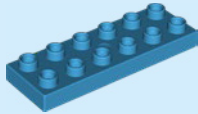

1x
6167685

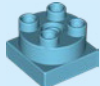

1x
6303199



1x
6172514

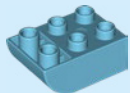

1x
6167834



1x
6478094



2x
4266228

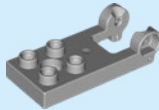

2x
6310412



1x
6464779

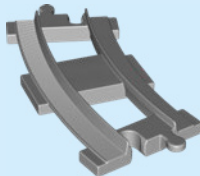

15x
6207493

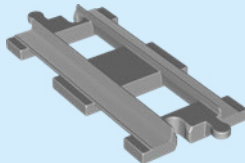

1x
6207494



1x
6478090



1x
6446310



1x
6480167



2x
4654789



1x
6478089



4x
6209859

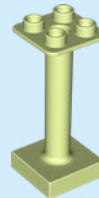

1x
6490943

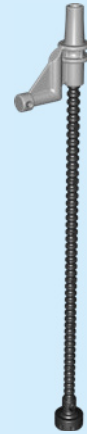

1x
4548111



1x
6478088



2x
6481109



1x
6466889

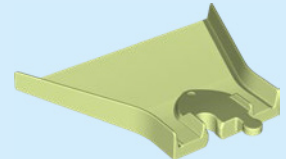

1x
6465960



1x
6376729



1x
6491600



1x
6478083



2x
4183780



1x
6491580



2x
6481108



2x
4226194



3x
6101121



1x
6127191



1x
6478087



1x
6393151



1x
6478085



1x
6478086



1x
6187321



1x
6104418



1x
6294240



2x
6490877



1x
6478084

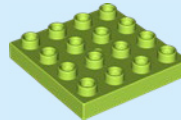

1x
6327077



1x
6214736

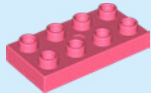

2x
6288476



1x
6481116



2x
343701

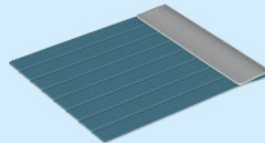

1x
6411819



1x
4121575



1x
6478080

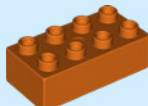

1x
6481102



1x
6481122



1x
6037884

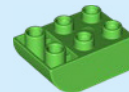

1x
6486218



2x
6481124



1x
6478078



1x
301101

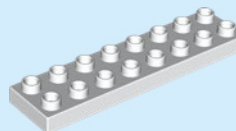

1x
4563575



1x
6478082



1x
6471949



2x
6481141

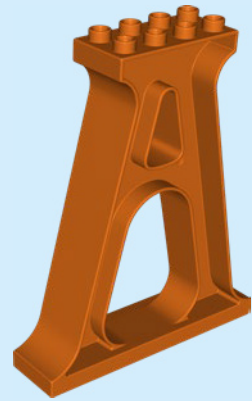

2x
6481132

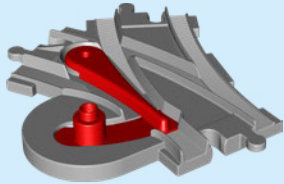

1x
6207508

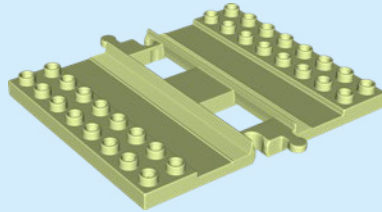

1x
6481090

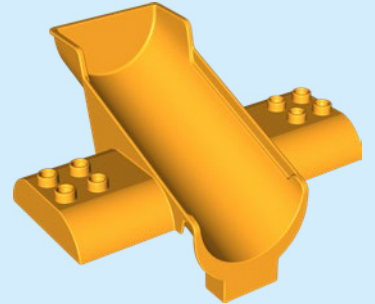

1x
6481138



1x
6478077

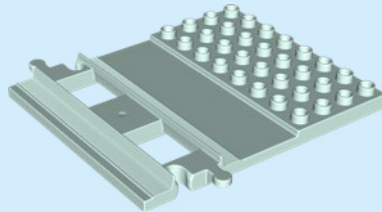

1x
6490945

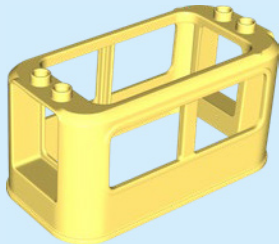

1x
6465964

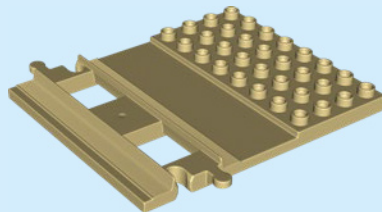

1x
6481125



 [LEGO.com/service](https://www.LEGO.com/service)

YOU COULD **WIN**

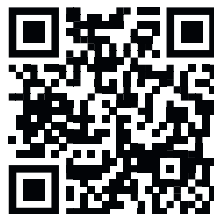

Scan this QR code or go to **LEGO.COM/PRODUCTFEEDBACK** and give us your short feedback about this LEGO® set for a chance to win a cool LEGO prize.

Terms and Conditions apply*

EN: YOU COULD WIN. Terms and Conditions apply* **DE: Du könntest GEWINNEN.** Es gelten die Teilnahmebedingungen* **FR: Tu pourrais GAGNER.** Des conditions s'appliquent* **IT: Potresti VINCERE tu.** Termini e condizioni sono applicabili* **ES: Puedes GANAR.** Aplican términos y condiciones* **PT: Poderá GANHAR.** Aplicam-se termos e condições* **ZH: 轻松获奖. 条款和条件适用*** **PL: Szansa na WYGRANĄ.** Obowiązują warunki korzystania* **CS: Máte šanci VYHRÁT.** Platí všeobecné smluvní podmínky* **SK: Máte šancu VYHRAŤ.** Platia všeobecné zmluvné podmienky* **HU: TE IS NYERHETSZ.** Felhasználási feltételek érvényesek* **RO: Ai putea CÂȘTIGA.** Se aplică termeni și condiții* **BG: Можете да СПЕЧЕЛИТЕ.** Има определени правила и условия* **LV: Tu vari LAIMĒT.** Ir spēkā noteikumi un nosacījumi.* **ET: Sul on võimalus VÕITA.** Kehtivad tingimused* **LT: Jūs galite LAIMĖTI.** Taikomos sąlygos*

*[LEGO.com/productfeedback-terms](https://www.lego.com/productfeedback-terms)

LEGO, the LEGO logo and DUPLO are trademarks of the LEGO Group. ©2025 The LEGO Group.