



# CITY

60472



LEGO® Builder



[LEGO.com/sustainable-packaging](https://LEGO.com/sustainable-packaging)



 <sup>FR</sup> **DONNEZ**  
OU  
**RECYCLEZ**

 OU  OU 

ASSOCIATION    MAGASIN    DÉCHÈTERIE

Adresses sur [quefairedemesdechets.fr](https://quefairedemesdechets.fr)

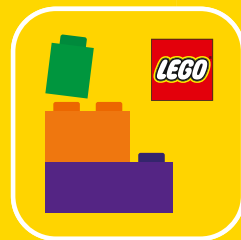

Q LEGO® Builder

# BUILDER



Apple and the Apple logo are trademarks of Apple Inc., registered in the U.S. and other countries and regions. App Store is a service mark of Apple Inc. Google Play and the Google Play logo are trademarks of Google LLC. Tencent and the Tencent logo are trademarks of Tencent Inc.

Q [LEGO.com/devicecheck](https://www.lego.com/devicecheck)

EN Ask parents' permission before going online | DE Eltern um Erlaubnis bitten, bevor du online gehst | FR Demande l'autorisation d'un parent avant d'aller en ligne | IT Chiedi il permesso ai tuoi genitori prima di andare online | ES Pídeles permiso a tus papás antes de conectarte a Internet | PT Pede autorização aos pais antes de acederes online | ZH 上网前应先征得父母的同意 | PL Poproś rodziców o zgodę, zanim wejdiesz do Internetu | CS Než půjdeš na internet, požádej rodiče o svolení | SK Skôr než pôjdeš na internet, vypýtaj si povolenie od rodičov | HU Kérj szülői engedélyt, mielőtt online csatlakoznál! | RO Cere permisiunea părinților înainte de a te conecta online | BG Поискайте разрешение от родител, преди да влезете онлайн | LV Pirms došanās tiešsaistē palūdz atļauju vecākiem | ET Enne Interneti kasutamist küsi vanematelt luba | LT Prieš prisijungdami prie interneto, atsiklauskite tėvų



**BUILD IT  
YOUR  
WAY**



**EN** Build It Your Way | **DE** Bau, wie du willst  
| **FR** Construisez à votre façon | **IT** Costruiscilo come  
vuoi tu | **ES** Constrúyelo a tu manera | **PT** Constrói à  
Tua Maneira | **ZH** 自由拼搭 | **PL** Zbuduj po swojemu  
| **CS** Postavte to po svém | **SK** Postavte to po svojom  
| **HU** Építs kedved szerint! | **RO** Construięște așa cum dorești  
| **BG** Постройте го по своя начин | **LV** Būvē tieši tā, kā  
vēlies | **ET** Ehita enda moodi | **LT** Sukonstruokite savaip



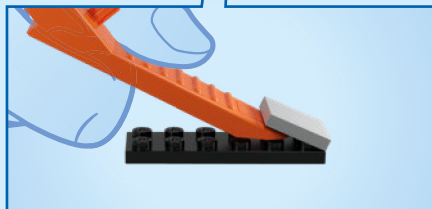
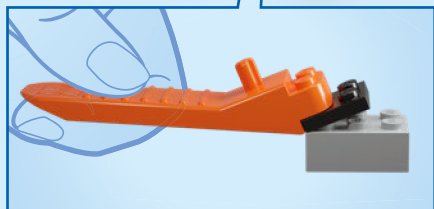
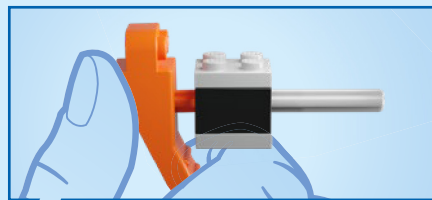
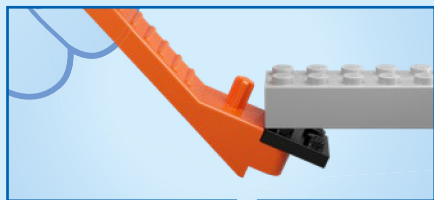

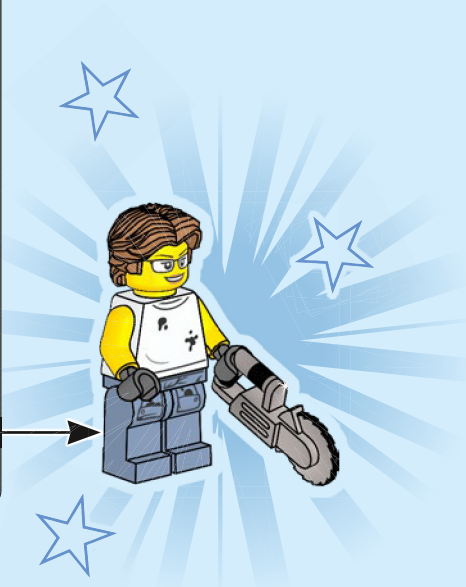
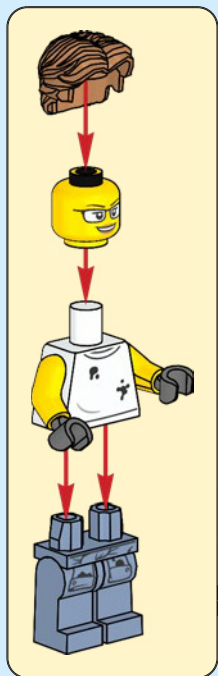

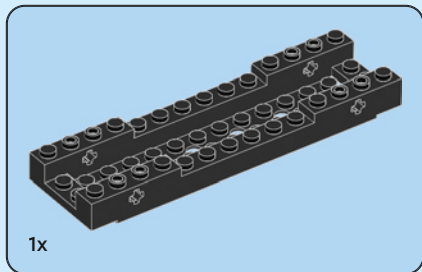

1

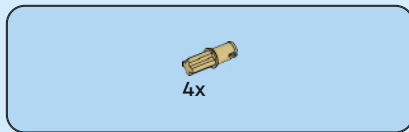
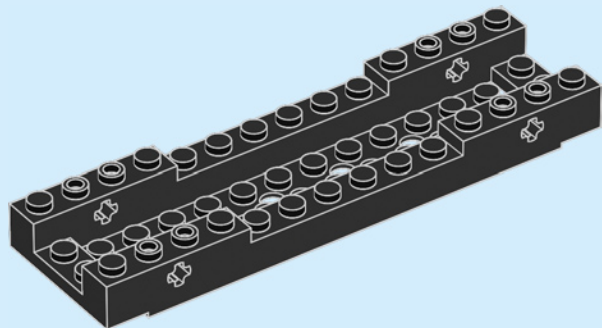

2

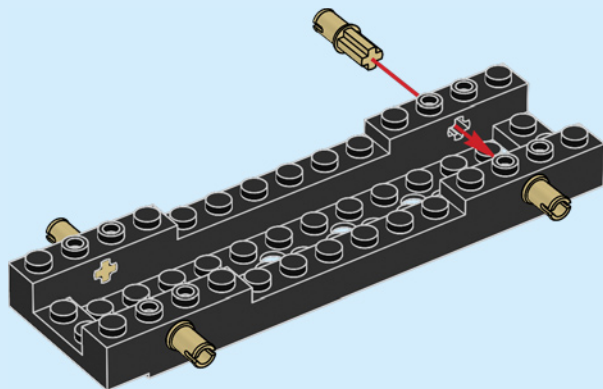





1x

3

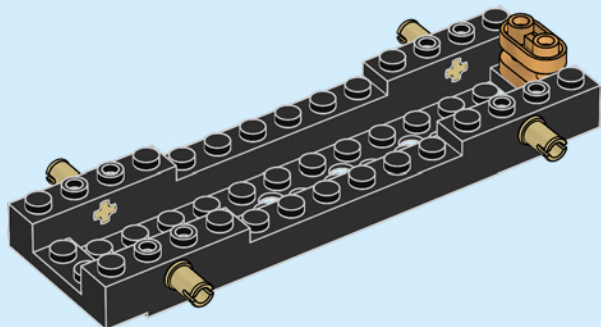

2x

4

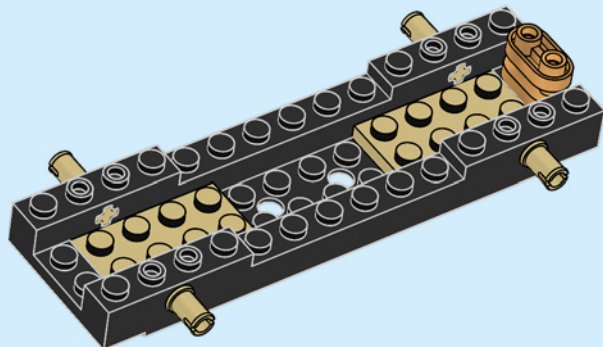



2x

5

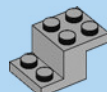
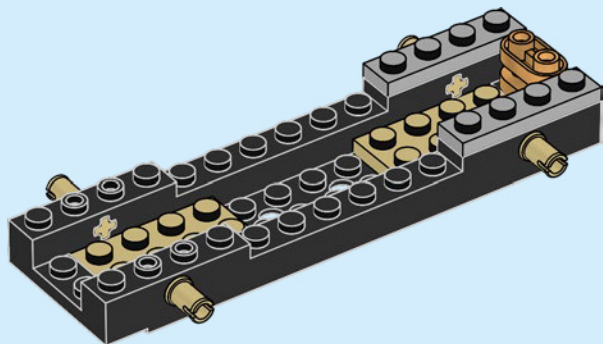

1x

6

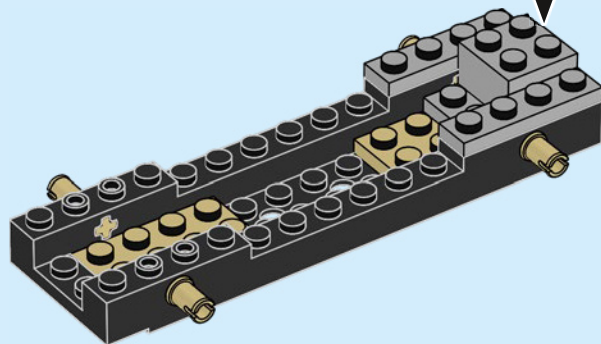
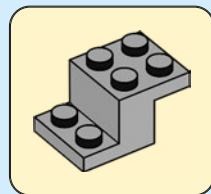

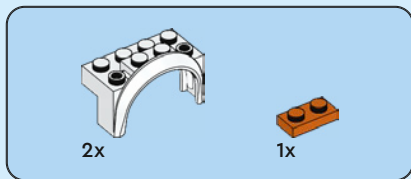

7

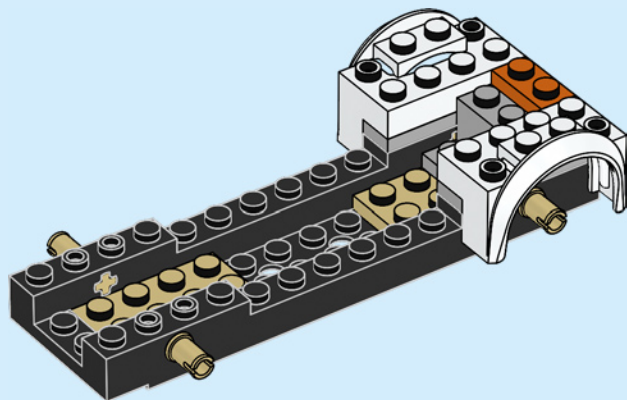

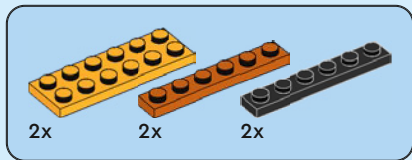

8

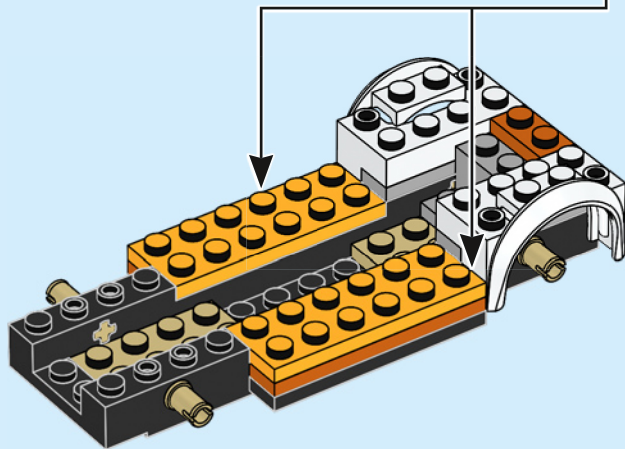
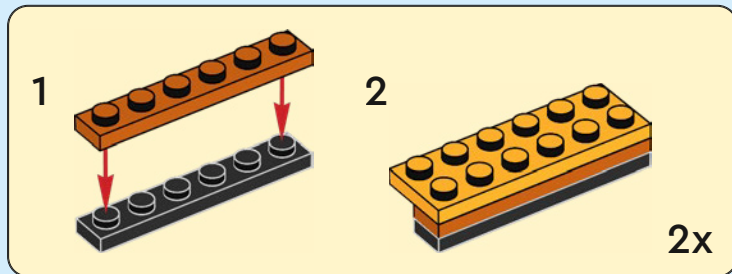

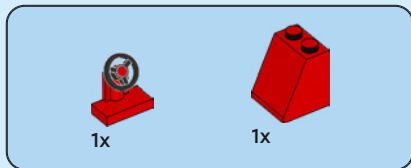

9

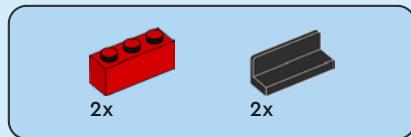
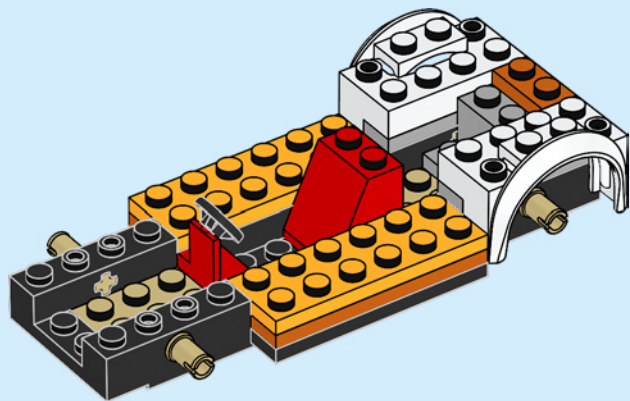

10

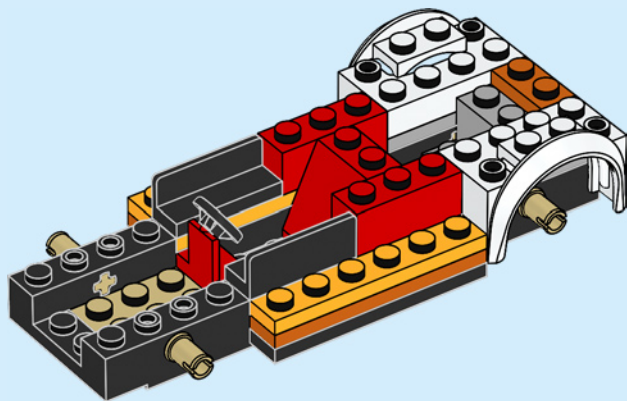



6x

11

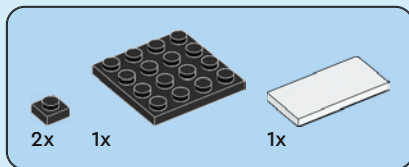
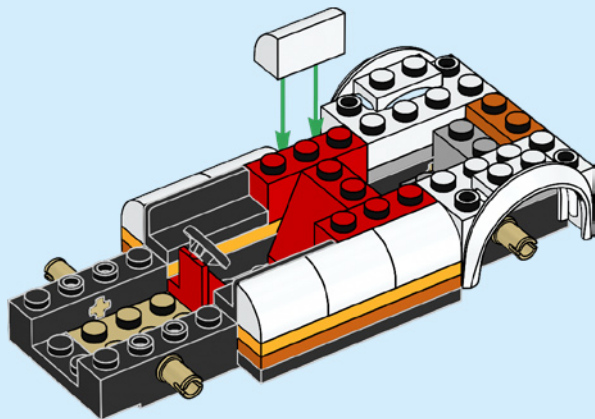

12

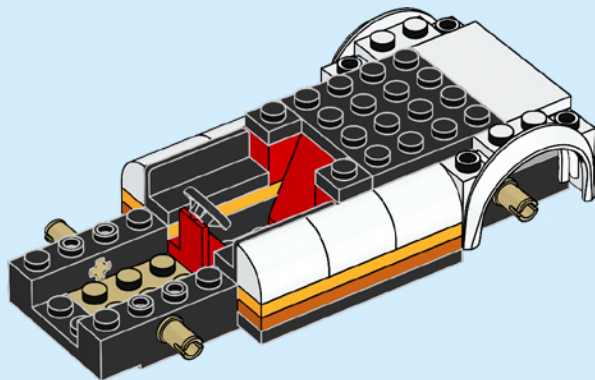



1x



1x

# 13

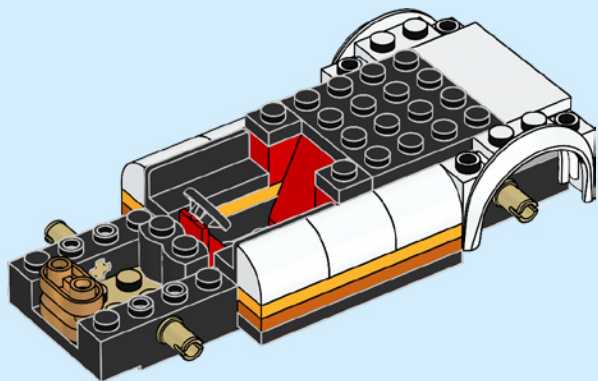

1x

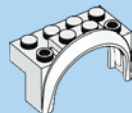

2x

# 14

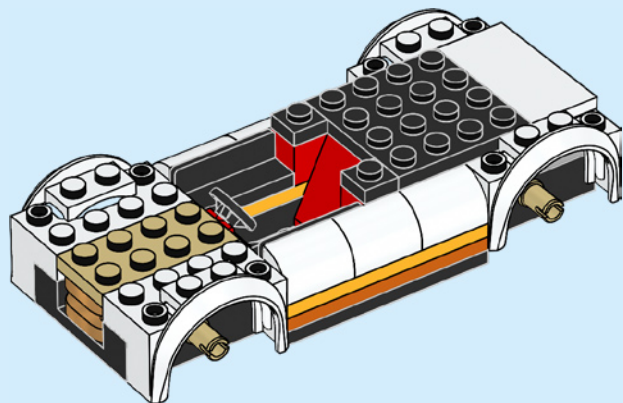

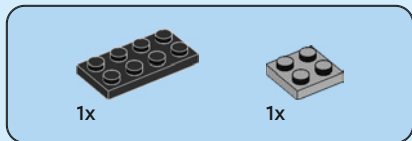

15

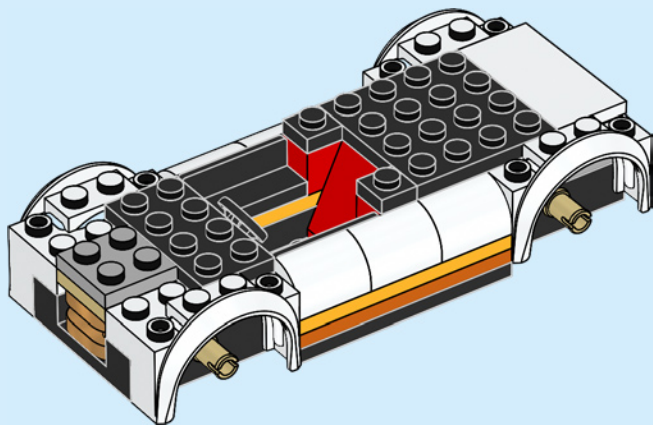





1x



2x

# 16

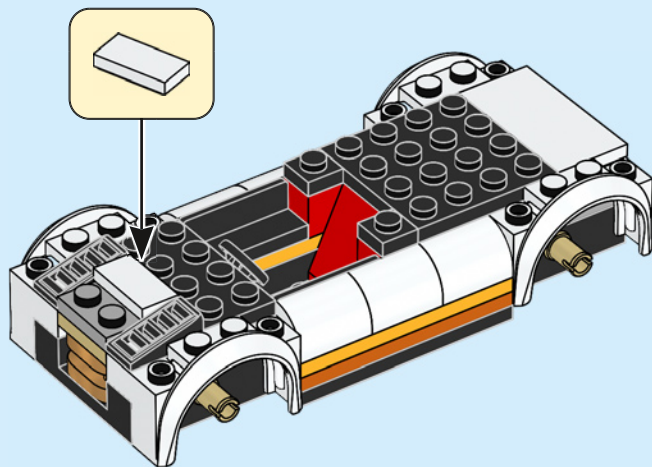



4x

17

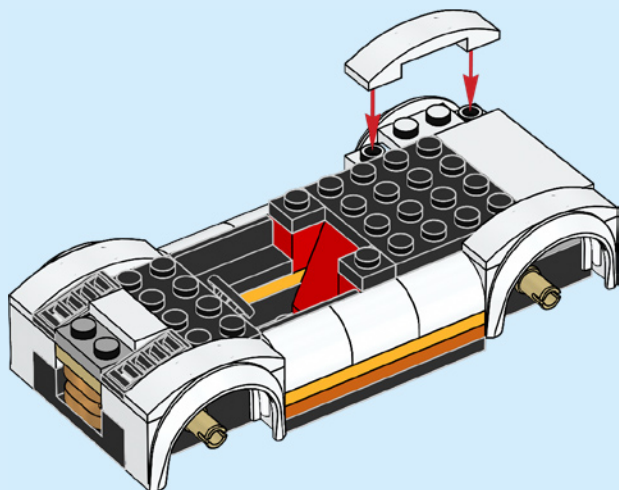

2x



2x

18

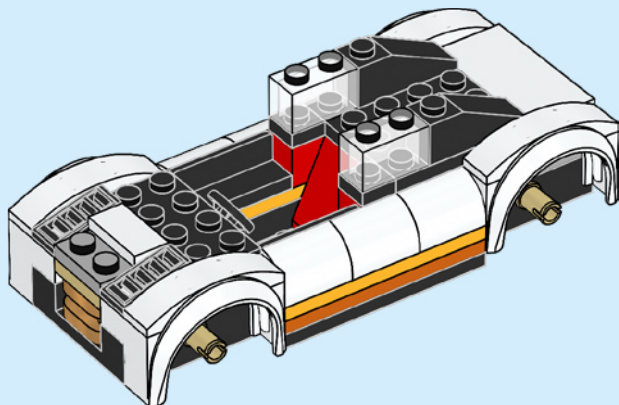



1x

19

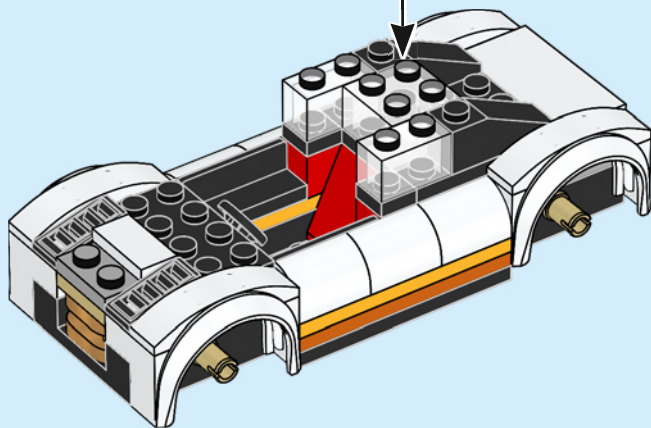

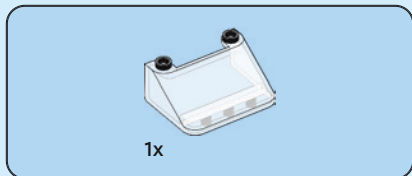

20

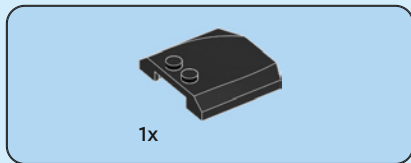
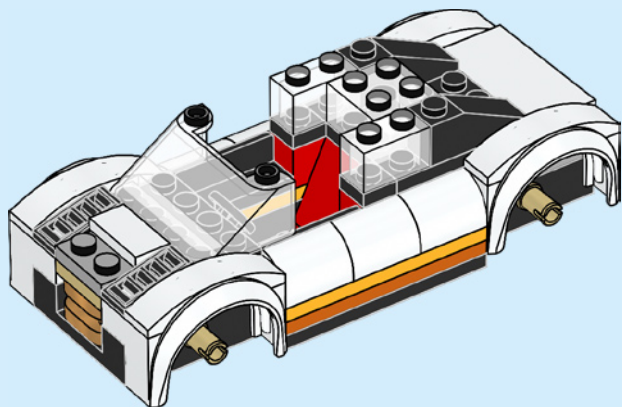

21

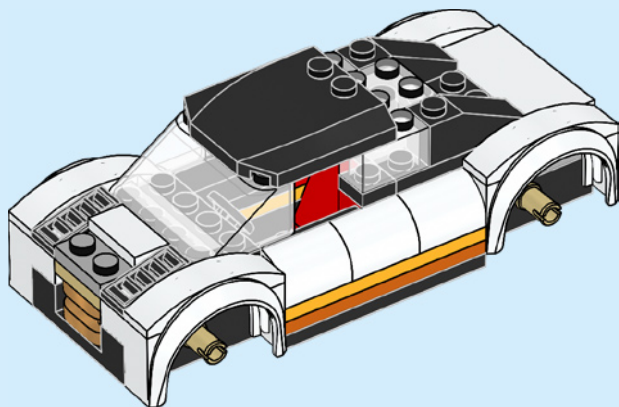

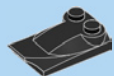

2x

22

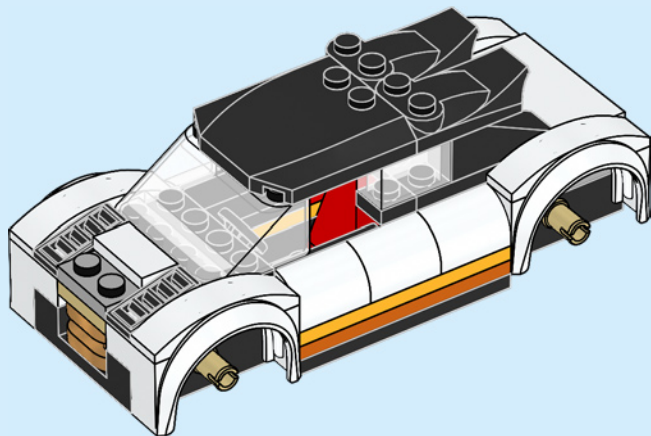

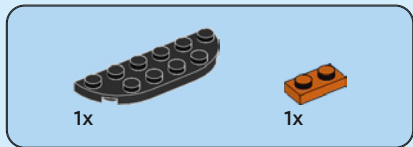

23

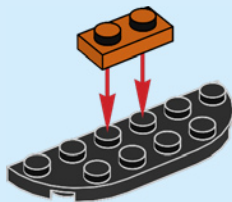

24

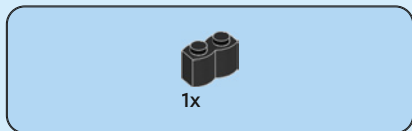

25

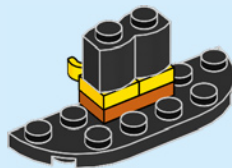

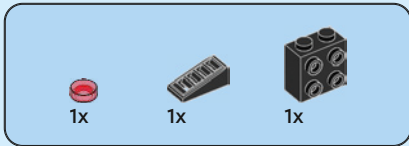

# 26

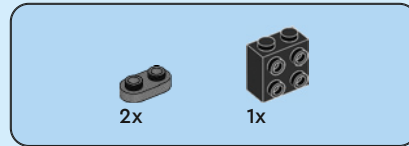
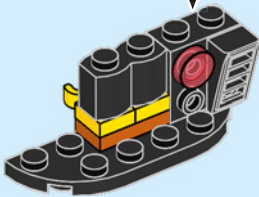
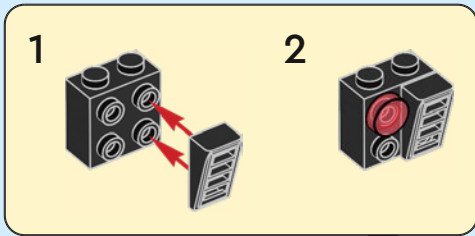

# 27

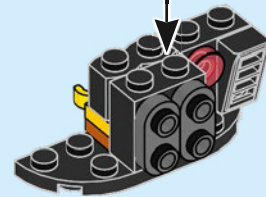
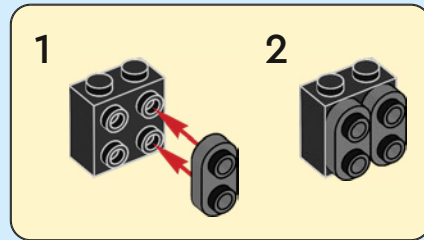

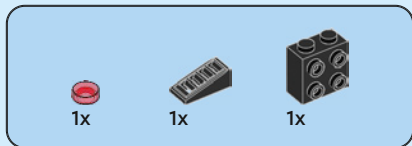

28

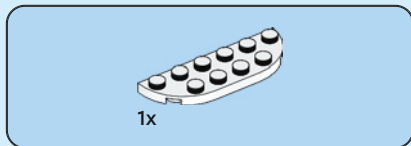
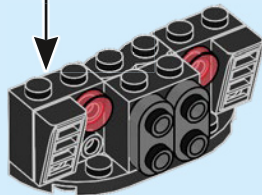
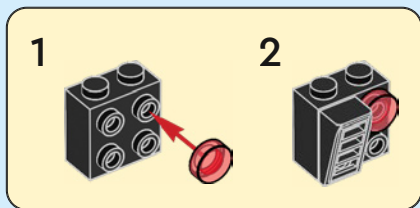

29

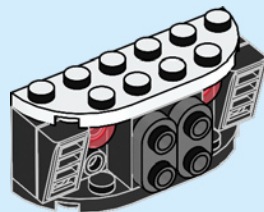



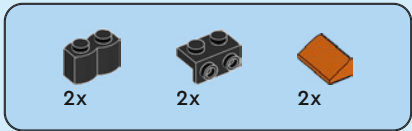

30

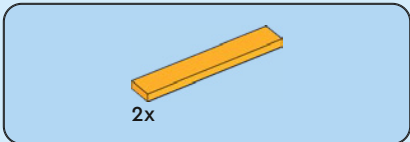
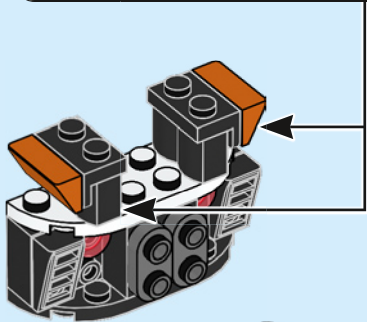
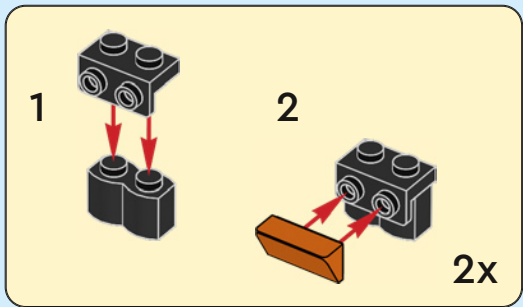

31



32

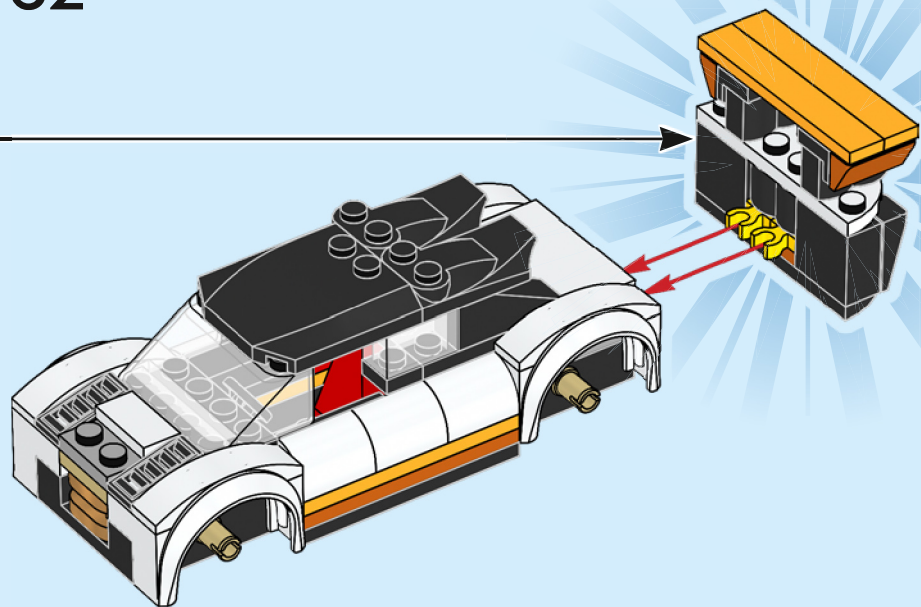

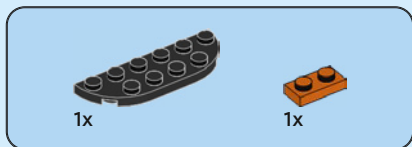
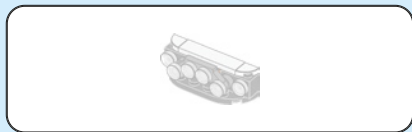

33

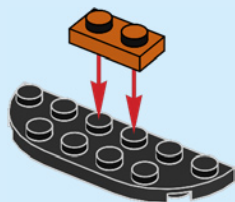

34

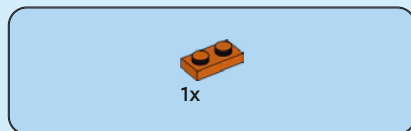

35





2x

36

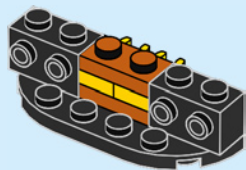

1x



2x

37

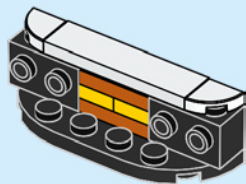



2x

# 38

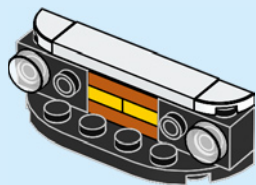

4x



1x

# 39

1

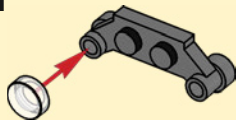

2

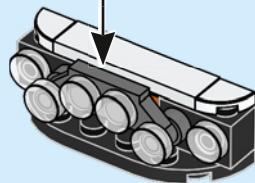

40

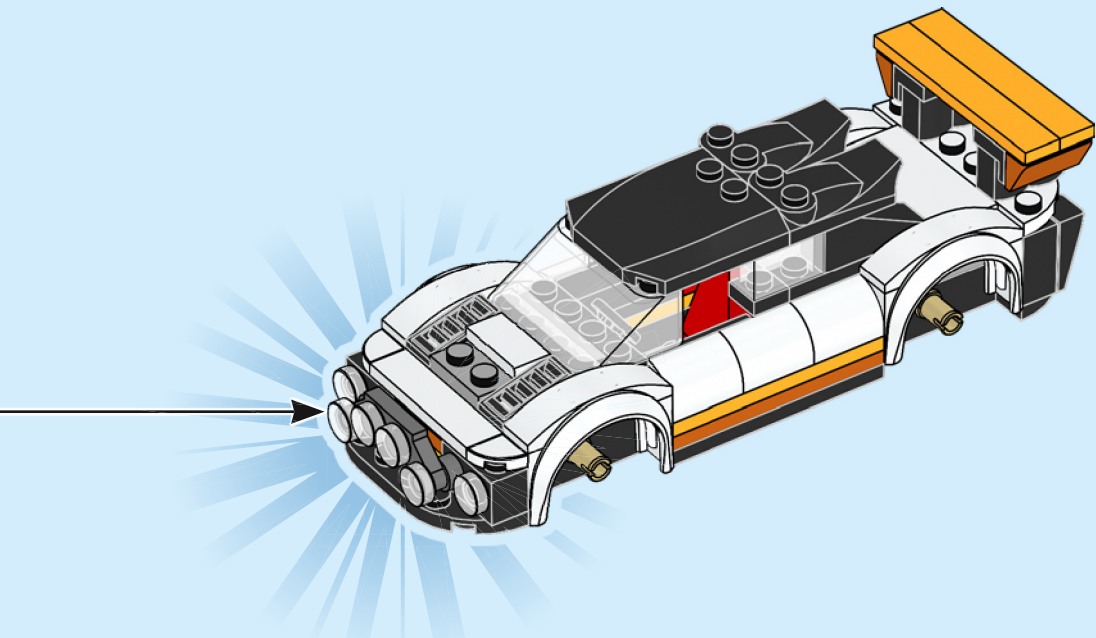



1x

41

1



2

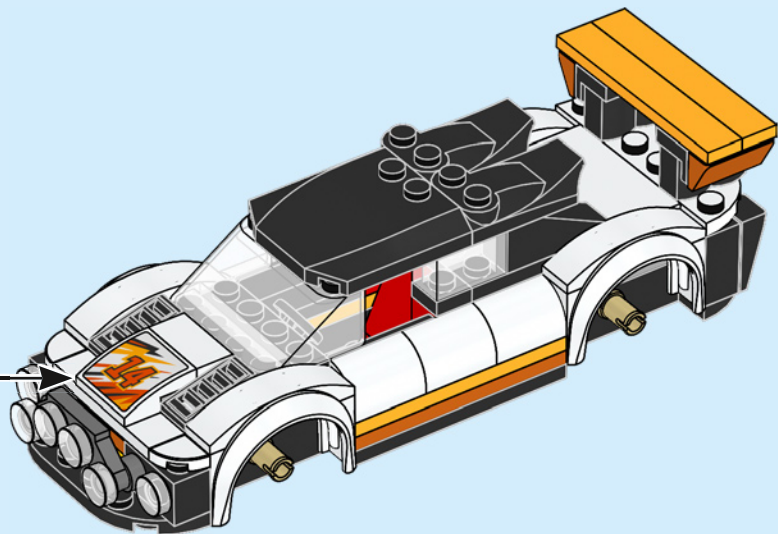

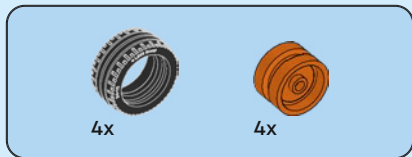

42

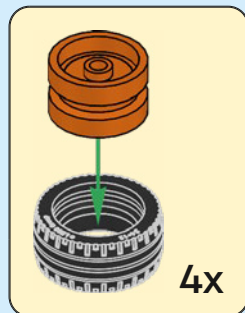
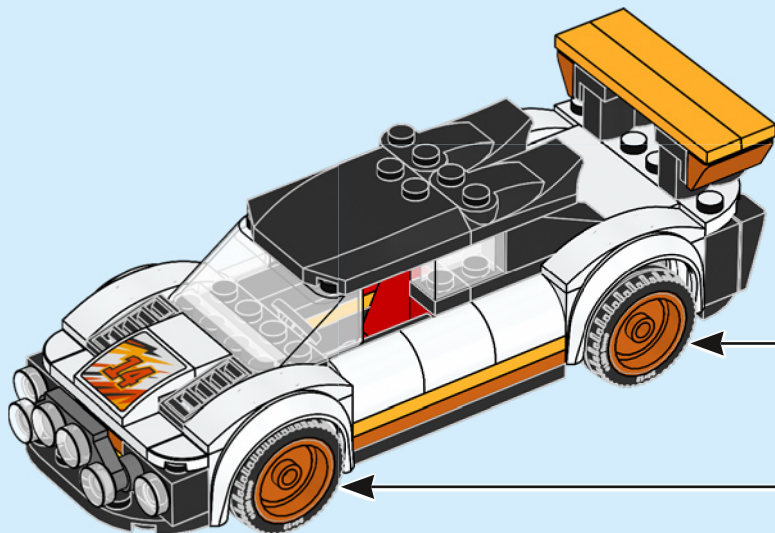



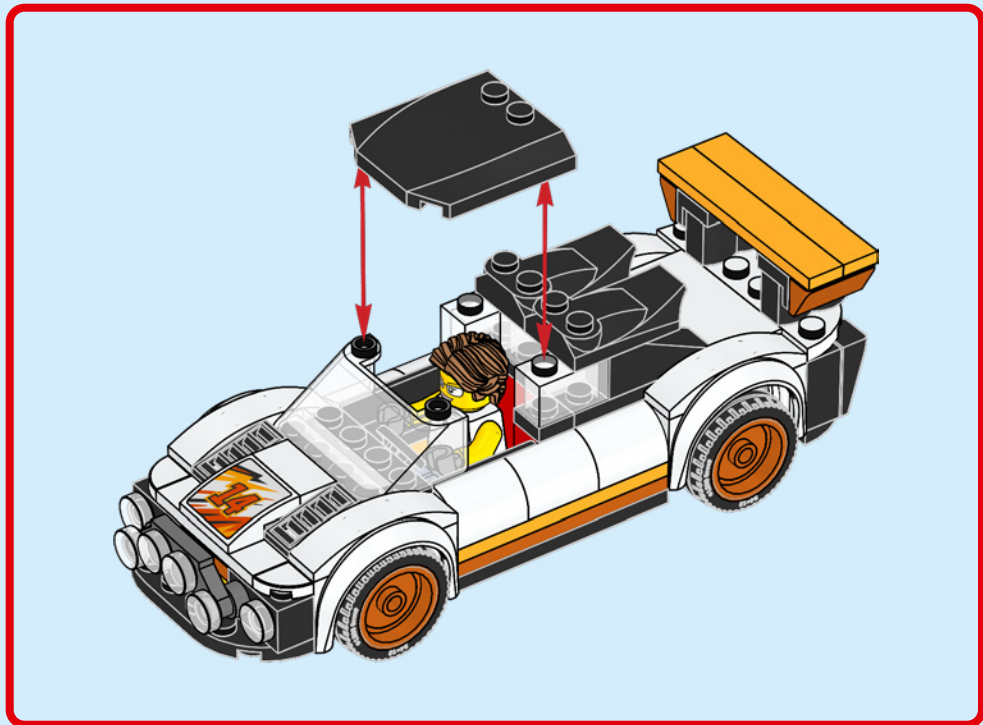

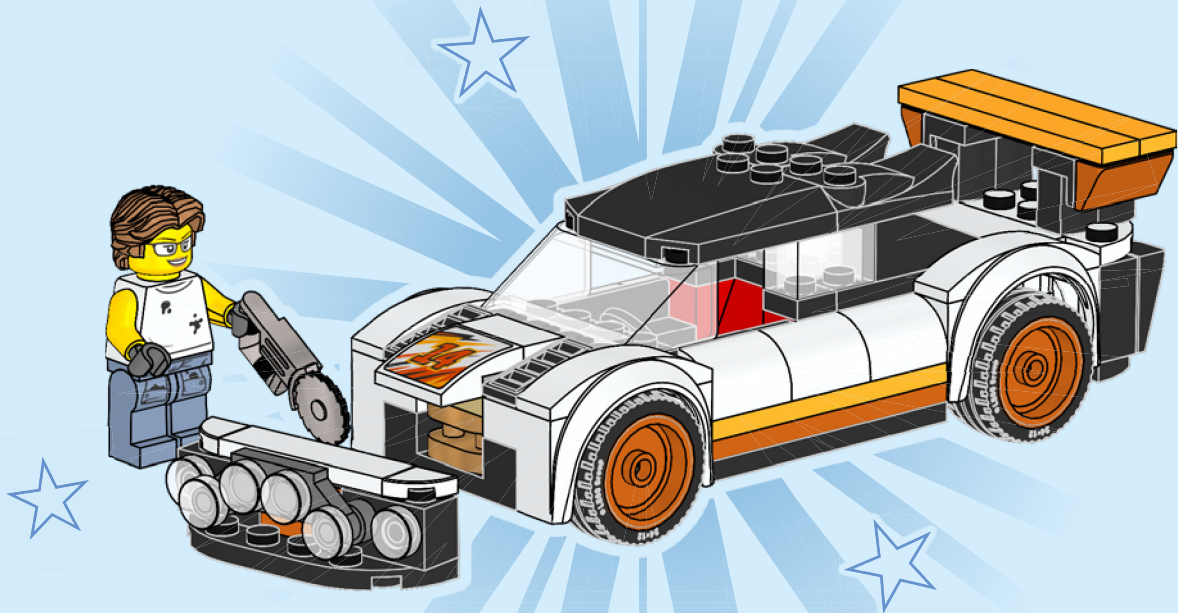



# CITY

60472



60462



60446



