

The LEGO logo, featuring the word "LEGO" in white, bold, sans-serif capital letters with a black outline, set against a red square background.The MARVEL logo, featuring the word "MARVEL" in white, bold, sans-serif capital letters with a black outline, set against a red rectangular background.

76307



Q LEGO® Builder



LEGO.com/sustainable-packaging



FR  
**DONNEZ**  
OU  
**RECYCLEZ**

 OU  OU 

ASSOCIATION    MAGASIN    DÉCHÈTERIE

Adresses sur [quefairedemesdechets.fr](http://quefairedemesdechets.fr)



Q LEGO® Builder

# BUILDER



Apple and the Apple logo are trademarks of Apple Inc., registered in the U.S. and other countries and regions. App Store is a service mark of Apple Inc. Google Play and the Google Play logo are trademarks of Google LLC. Tencent and the Tencent logo are trademarks of Tencent Inc.

Q [LEGO.com/devicecheck](https://LEGO.com/devicecheck)

**EN** Ask parents' permission before going online | **DE** Eltern um Erlaubnis bitten, bevor du online gehst | **FR** Demande l'autorisation d'un parent avant d'aller en ligne | **IT** Chiedi il permesso ai tuoi genitori prima di andare online | **ES** Pídeles permiso a tus papás antes de conectarte a Internet | **PT** Peça autorização aos pais antes de acederes online | **ZH** 上网前应先征得父母的同意 | **PL** Poproś rodziców o zgodę, zanim wejdiesz do Internetu | **CS** Než půjdeš na internet, požádej rodiče o svolení | **SK** Skôr než pôjdeš na internet, vypýtaj si povolenie od rodičov | **HU** Kérj szülői engedélyt, mielőtt online csatlakoznál! | **RO** Cere permisiunea părinților înainte de a te conecta online | **BG** Поискайте разрешение от родител, преди да влезете онлайн | **LV** Pirms došanās tiešsaistē palūdz atļauju vecākiem | **ET** Enne Interneti kasutamist küsi vanematelt luba | **LT** Prieš prisijungdami prie interneto, atsiklauskite tėvų





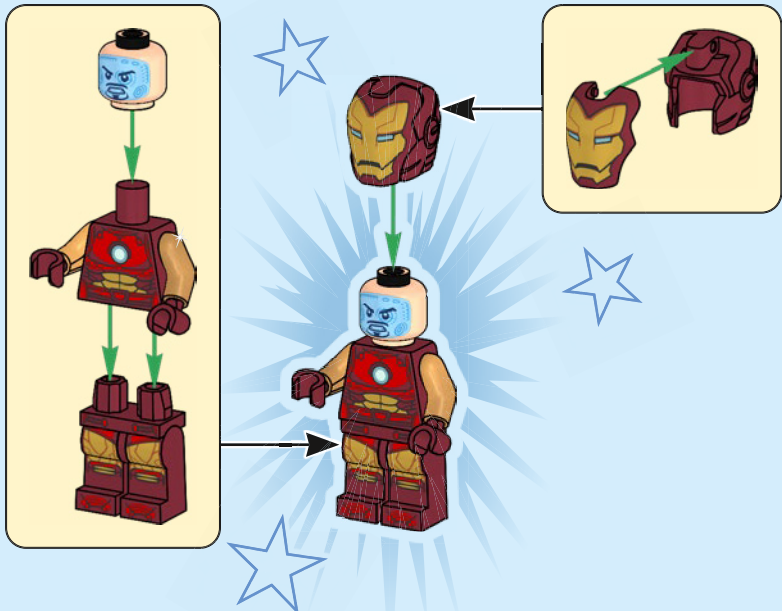

1

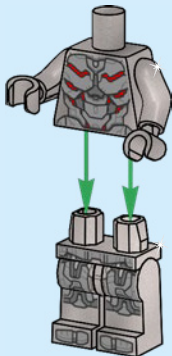

2

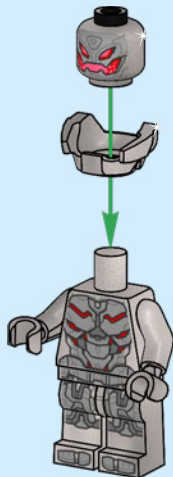

3

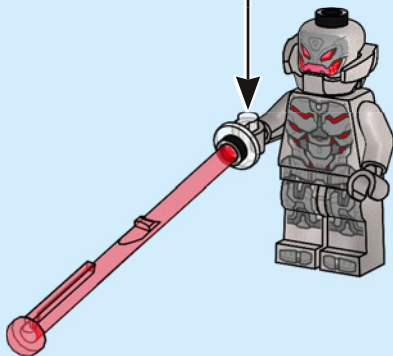
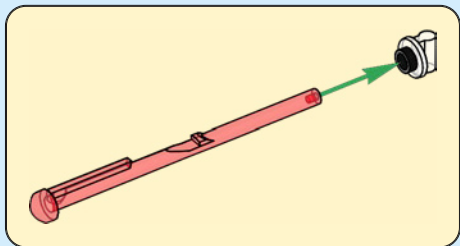

4

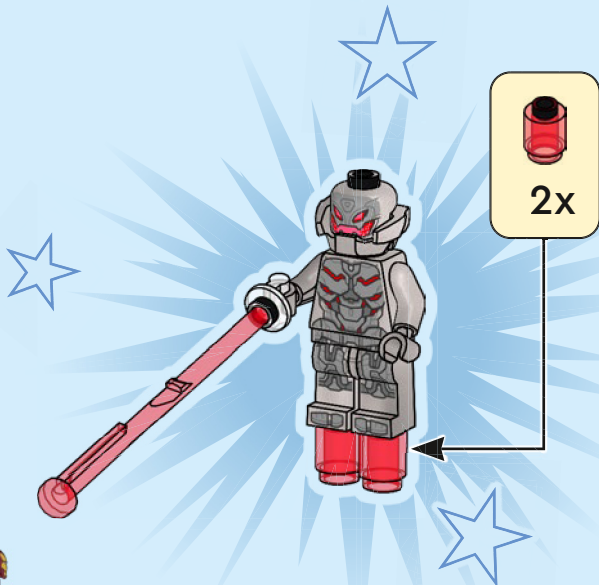



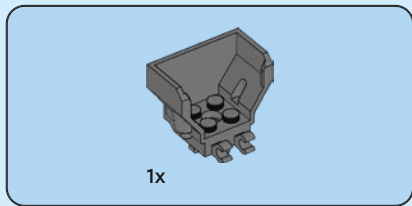

1

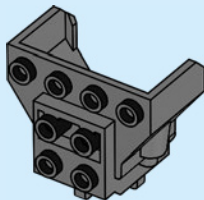



2x

2

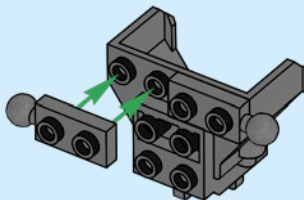



2x

3

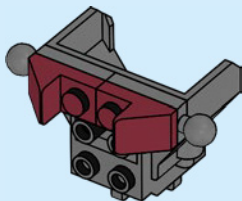

1x

4

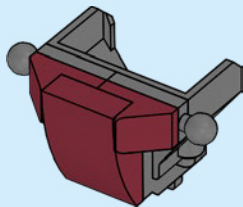



1x



1x

5

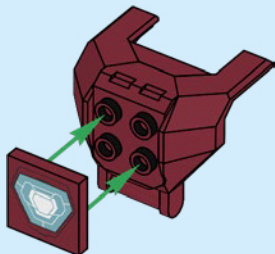

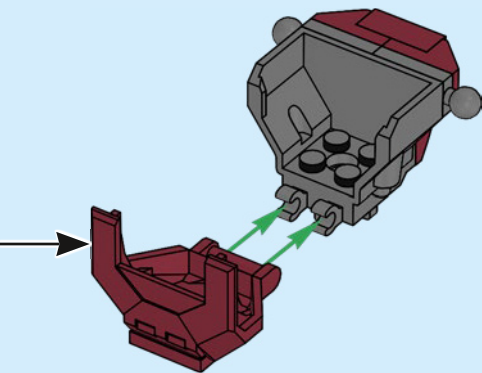

6

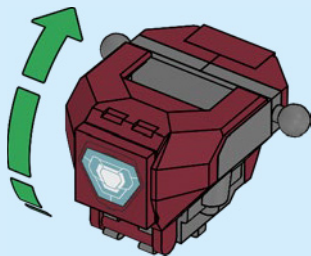



1x

7

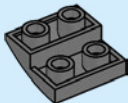

1x

8

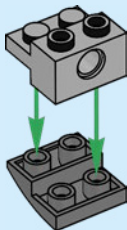



1x

9

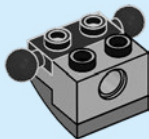

2x

10

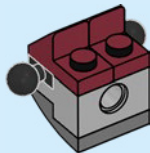



2x

11

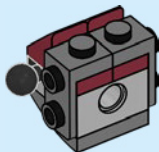

3x

12

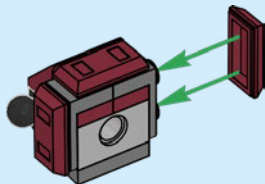





1x

13

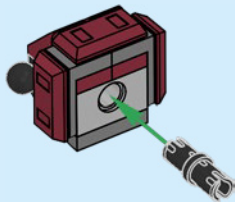

14

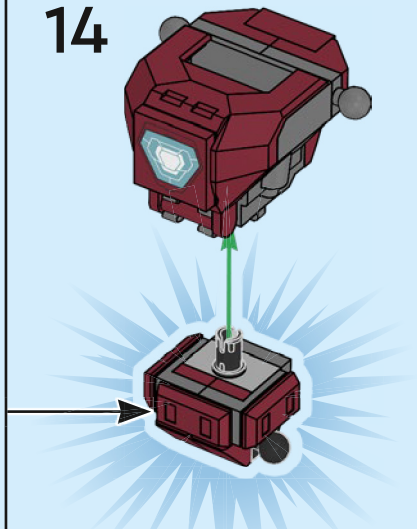



2x



1x

15

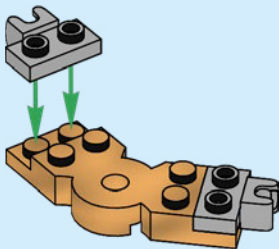

1x

16

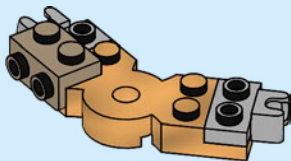



1x



1x

17

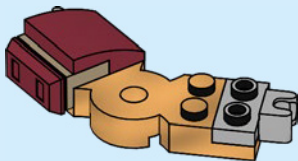

1x

18

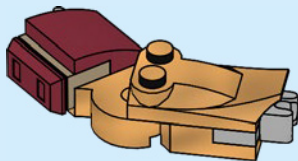



1x

19

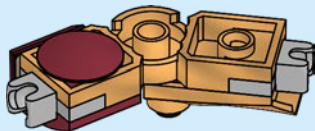

20

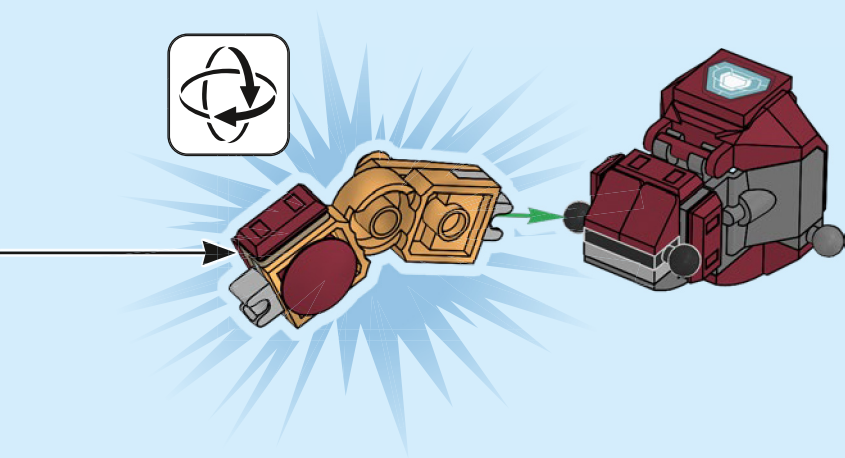



2x



1x

21

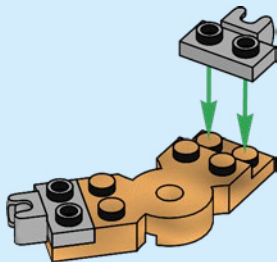

1x

22

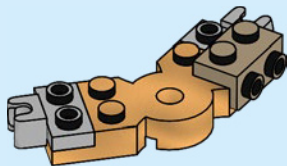



1x



1x

# 23

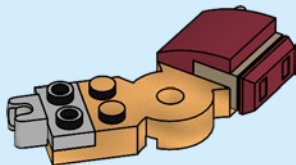

1x

# 24

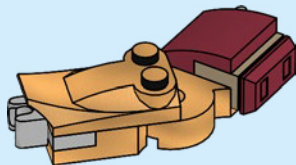



1x

25

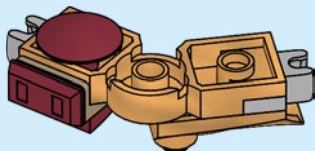



26

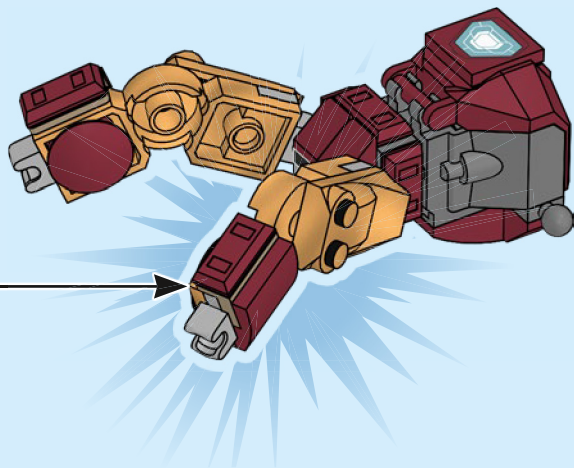



1x

27



26



1x



1x

28

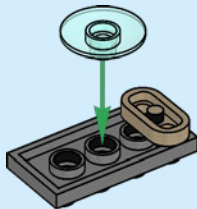



1x

29



1x

30

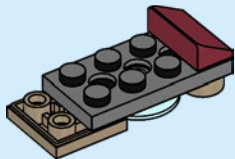



1x



1x

31

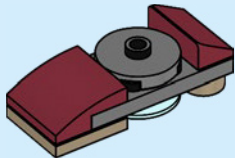

1x

32

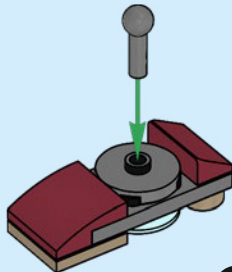

2x



33

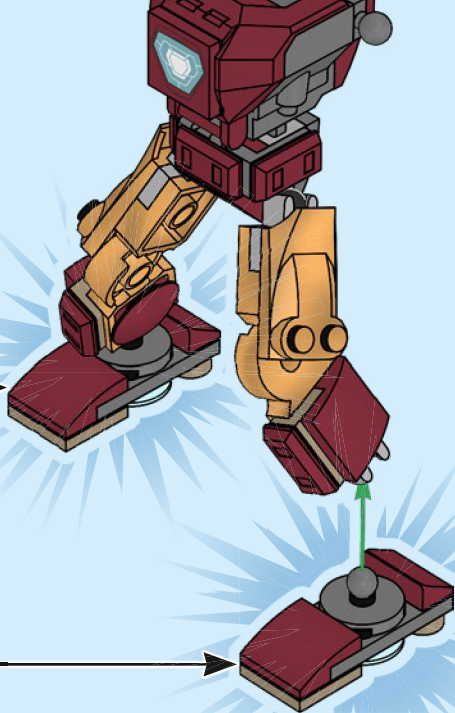



1x



1x

34

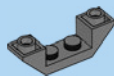
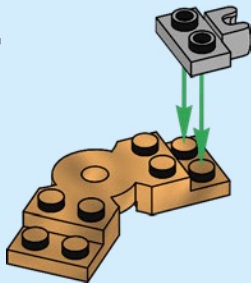

1x

35

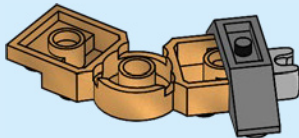



1x

36

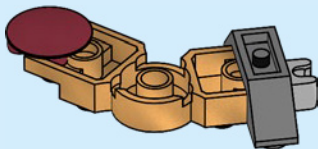

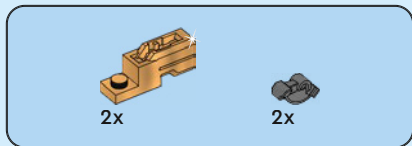

37

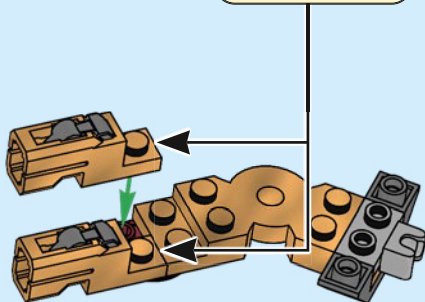
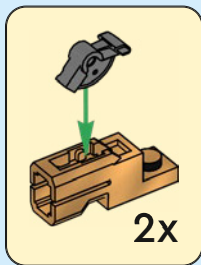





1x

38

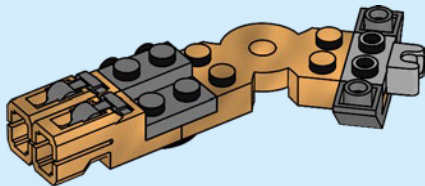



1x

39

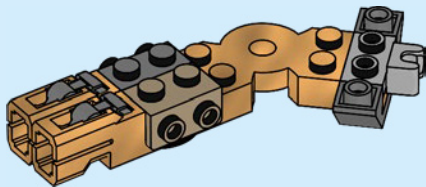



1x



2x

# 40

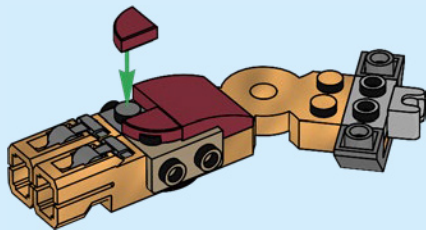



1x

41





1x

42

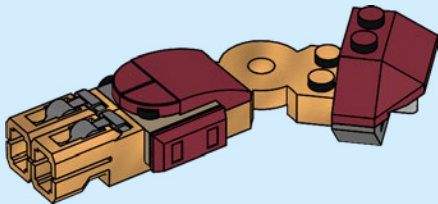



1x

43

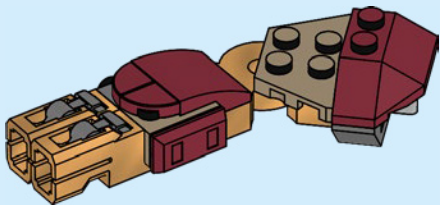



1x

44

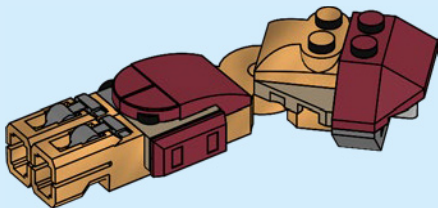



1x

45

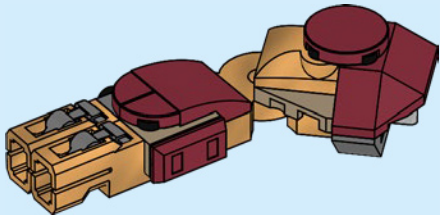



46

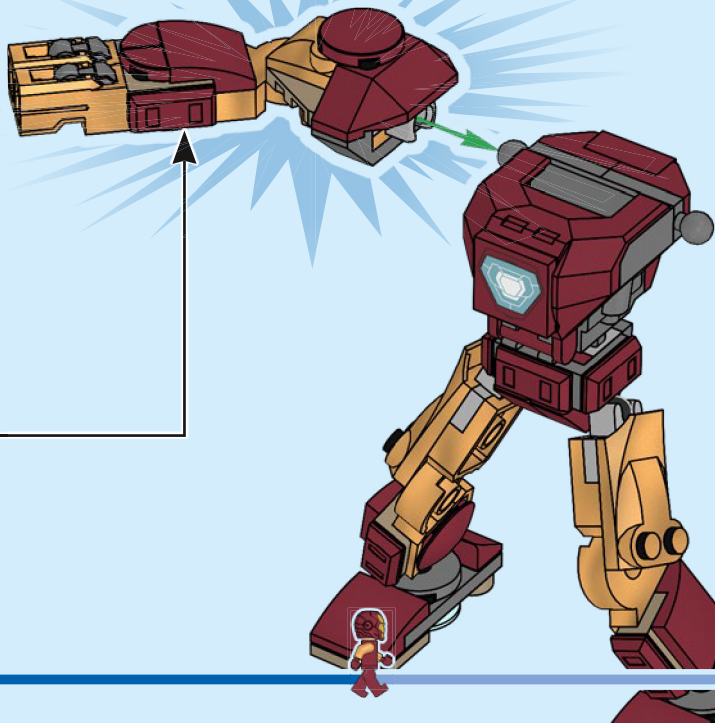

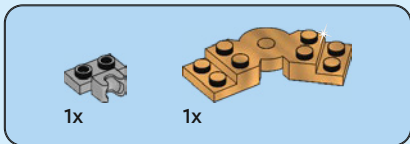

47

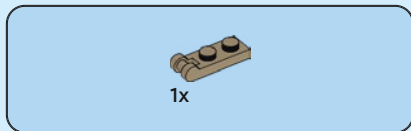
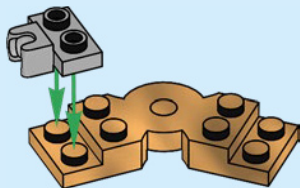

48

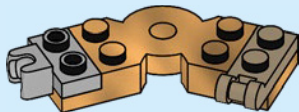

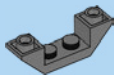

1x



1x

49

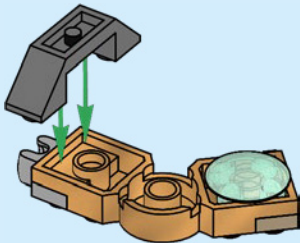

50

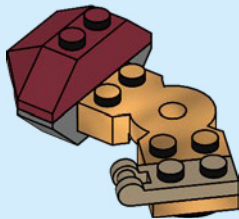



1x

51

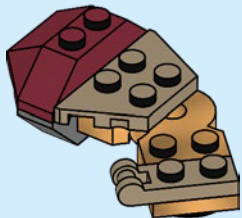

1x

52

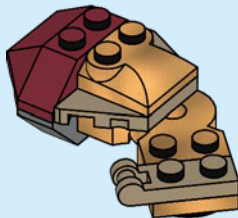



1x

53

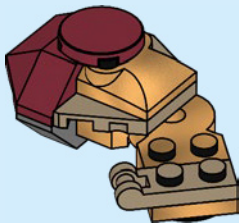

1x

54

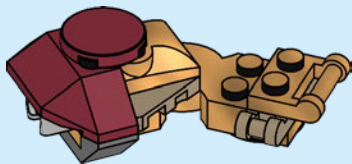



1x

55

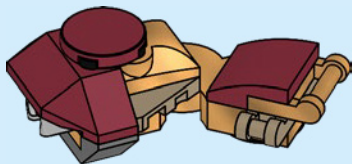

4x

56

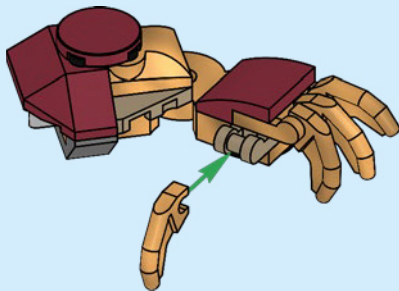

57

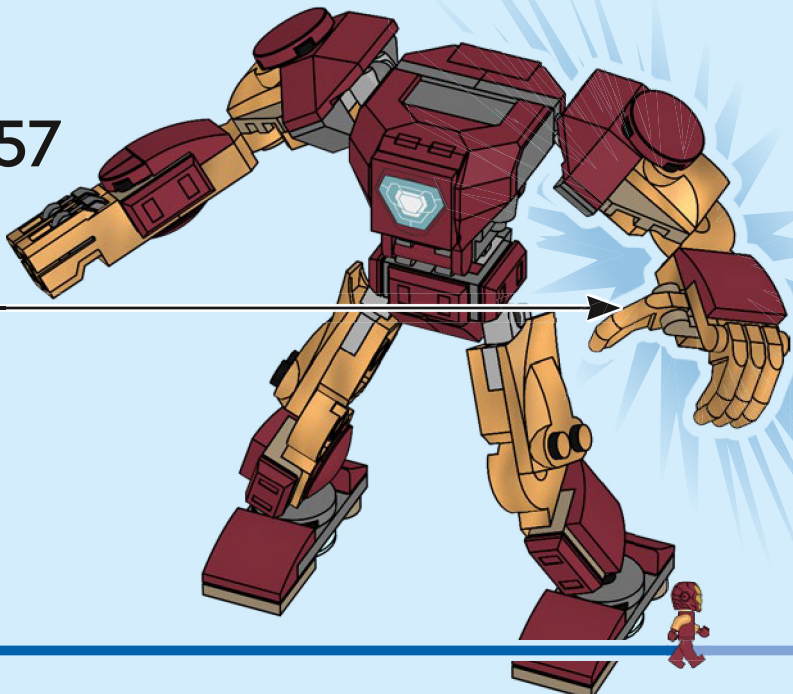

58

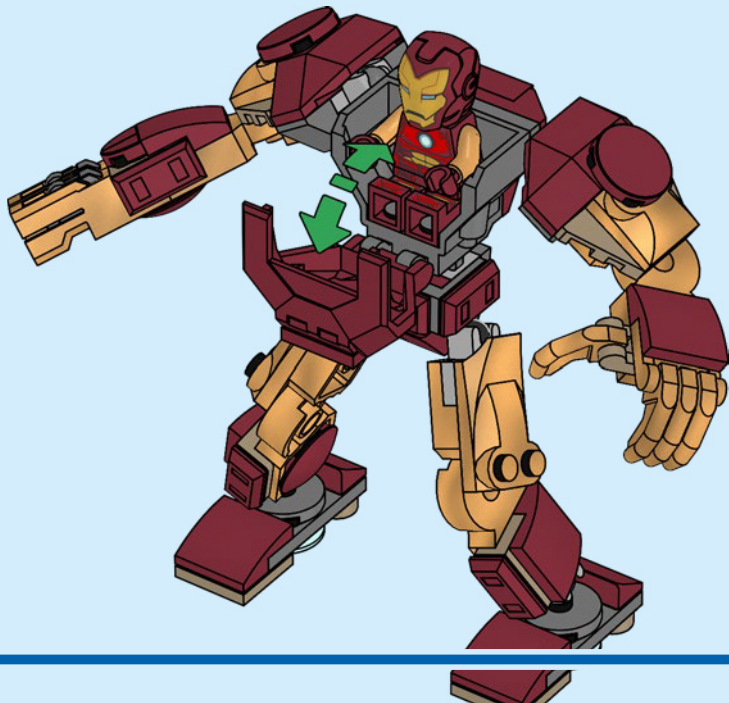



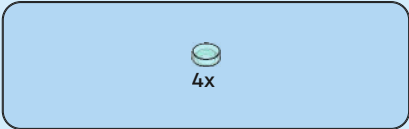

59

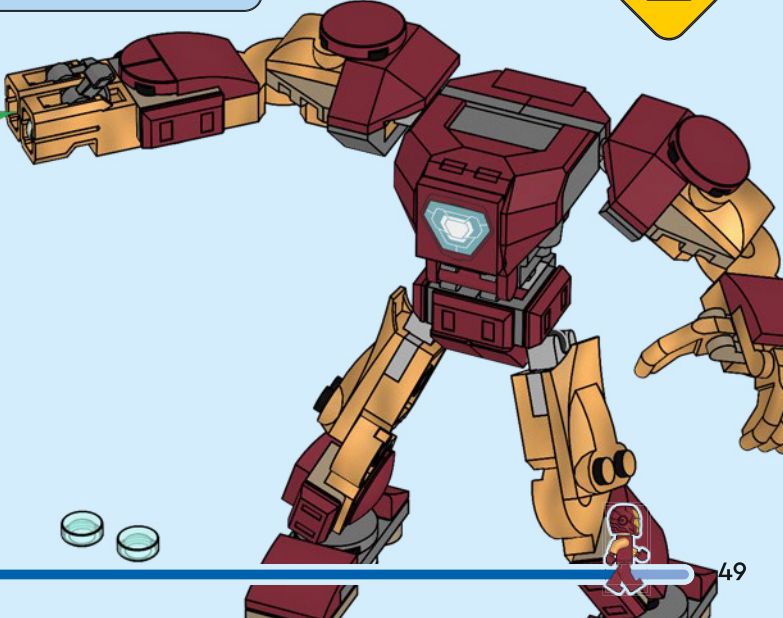

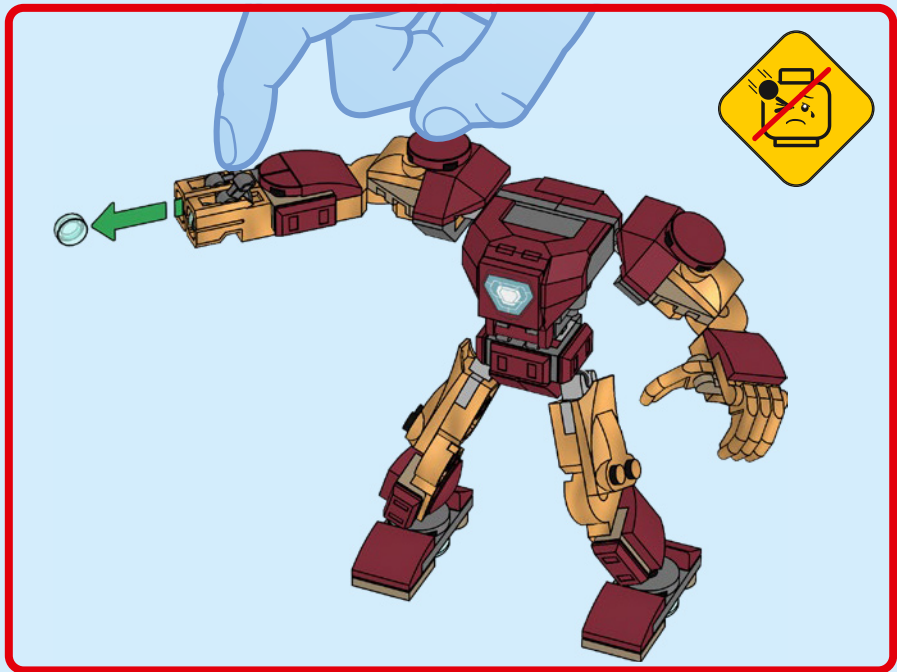

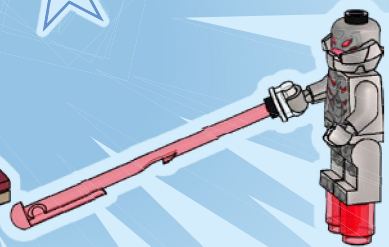
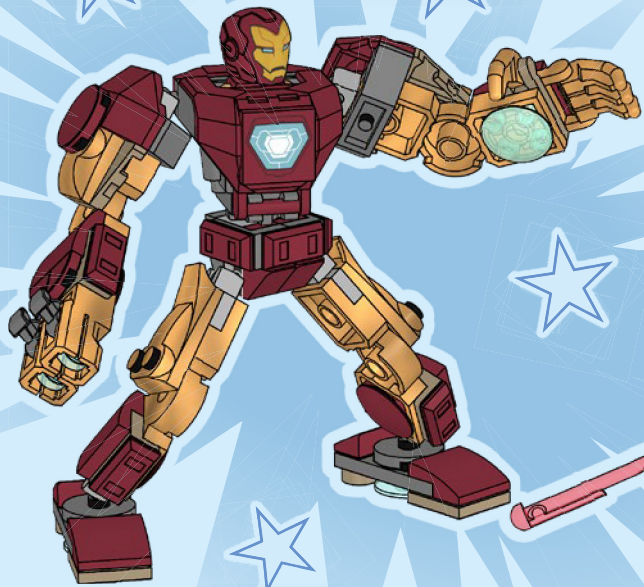

**LEGO**

**MARVEL**



76313



76314



76310



76307

**MARVEL**  
**AVENGERS**



1x  
6279875



2x  
6245307



2x  
6311890



1x  
6448822



1x  
6264031



1x  
6416838



2x  
6231386



1x  
6526663



6x  
6448315



2x  
6525969



1x  
6510217



3x  
6328477



1x  
6398321



4x  
6251611



1x  
6440776



2x  
6514235



2x  
6406008



2x  
6083977



6x  
6107758



6x  
6043656



1x  
6287550



1x  
6135607



3x  
6192839



1x  
6526664



1x  
6326478



4x  
6514192



2x  
6003379



2x  
6264149



1x  
6453200



2x  
6435043

2x  
6364352

2x  
6123814

1x  
6469463

1x  
6221340

4x  
6525970

2x  
6360675

1x  
6344820

2x  
6185675

4x  
6426622

1x  
6526665

2x  
6115080

2x  
4227398

1x  
4585493

1x  
6526617



1x  
6384443

2x  
4286597

2x  
6345949

1x  
6531888

 [LEGO.com/service](https://www.LEGO.com/service)

2x  
6357918

1x  
6350385



Rebuild  
the  
World 

YOU COULD **WIN**



Scan this QR code or go to **LEGO.COM/PRODUCTFEEDBACK** and give us your short feedback about this LEGO® set for a chance to win a cool LEGO prize.

Terms and Conditions apply\*



**EN: YOU COULD WIN.** Terms and Conditions apply\* **DE: Du könntest GEWINNEN.** Es gelten die Teilnahmebedingungen\* **FR: Tu pourrais GAGNER.** Des conditions s'appliquent\* **IT: Potresti VINCERE tu.** Termini e condizioni sono applicabili\* **ES: Puedes GANAR.** Aplican términos y condiciones\* **PT: Poderá GANHAR.** Aplicam-se termos e condições\* **ZH: 轻松获奖.** 条款和条件适用\* **PL: Szansa na WYGRANĄ.** Obowiązują warunki korzystania\* **CS: Máte šanci VYHRÁT.** Platí všeobecné smluvní podmínky\* **SK: Máte šancu VYHRÁT.** Platia všeobecné zmluvné podmienky\* **HU: TE IS NYERHETSZ.** Felhasználási feltételek érvényesek\* **RO: Ai putea CÂȘTIGA.** Se aplică termenii și condiții\* **BG: Можете да СПЕЧЕЛИТЕ.** Има определени правила и условия\* **LV: Tu vari LAIMĒT.** Ir spēkā noteikumi un nosacījumi.\* **ET: Sul on võimalus VÕITA.** Kehtivad tingimused\* **LT: Jūs galite LAIMĖTI.** Taikomos sąlygos\*

\*[LEGO.com/productfeedback-terms](https://www.lego.com/productfeedback-terms)

LEGO and the LEGO logo are trademarks of the LEGO Group. ©2025 The LEGO Group.

© 2025 MARVEL

6559641