



CITY

60443







LEGO® Builder



[LEGO.com/sustainable-packaging](https://LEGO.com/sustainable-packaging)



 **FR**  
**DONNEZ**  
OU  
**RECYCLEZ**

 OU  OU 

ASSOCIATION MAGASIN DÉCHÈTERIE

Adresses sur [quefairedemesdechets.fr](https://quefairedemesdechets.fr)

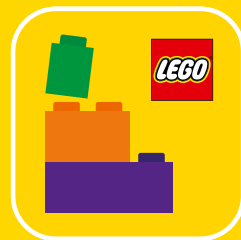

Q LEGO® Builder

# BUILDER



Apple and the Apple logo are trademarks of Apple Inc., registered in the U.S. and other countries and regions. App Store is a service mark of Apple Inc. Google Play and the Google Play logo are trademarks of Google LLC. Tencent and the Tencent logo are trademarks of Tencent Inc.

Q [LEGO.com/devicecheck](https://www.lego.com/devicecheck)

EN Ask parents' permission before going online | DE Eltern um Erlaubnis bitten, bevor du online gehst | FR Demande l'autorisation d'un parent avant d'aller en ligne | IT Chiedi il permesso ai tuoi genitori prima di andare online | ES Pídeles permiso a tus papás antes de conectarte a Internet | PT Pede autorização aos pais antes de acederes online | ZH 上网前应先征得父母的同意 | PL Poproś rodziców o zgodę, zanim wejdiesz do Internetu | CS Než půjdeš na internet, požádej rodiče o svolení | SK Skôr než pôjdeš na internet, vypýtaj si povolenie od rodičov | HU Kérj szülői engedélyt, mielőtt online csatlakoznál! | RO Cere permisiunea părinților înainte de a te conecta online | BG Поискайте разрешение от родител, преди да влезете онлайн | LV Pirms došanās tiešsaistē palūdz atļauju vecākiem | ET Enne Interneti kasutamist küsi vanematelt luba | LT Prieš prisijungdami prie interneto, atsiklauskite tėvų

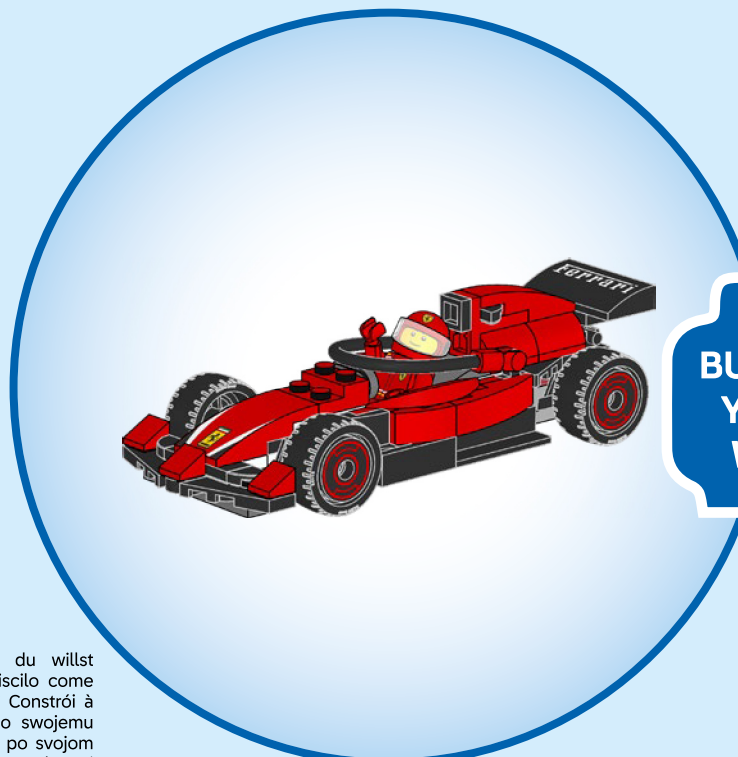

**BUILD IT  
YOUR  
WAY**



**EN** Build It Your Way | **DE** Bau, wie du willst  
| **FR** Construisez à votre façon | **IT** Costruiscilo come  
vuoi tu | **ES** Constrúyelo a tu manera | **PT** Constrói à  
Tua Maneira | **ZH** 自由拼搭 | **PL** Zbuduj po swojemu  
| **CS** Postavte to po svém | **SK** Postavte to po svojom  
| **HU** Építs kedved szerint! | **RO** Construięște așa cum dorești  
| **BG** Постройте го по своя начин | **LV** Būvē tieši tā, kā  
vēlies | **ET** Ehita enda moodi | **LT** Sukonstruokite savaip

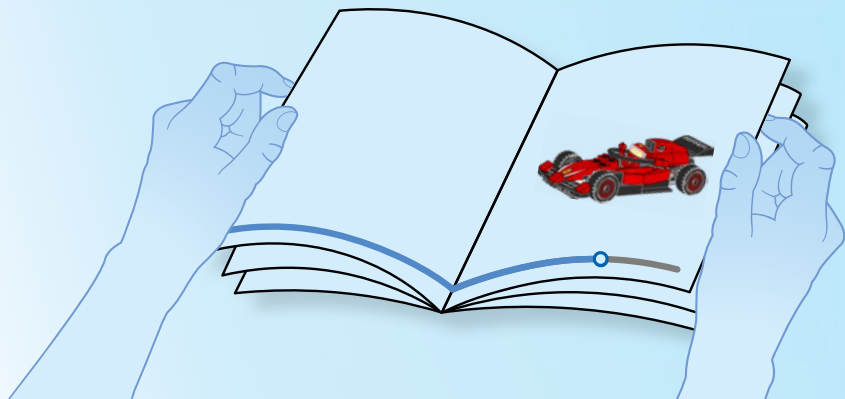



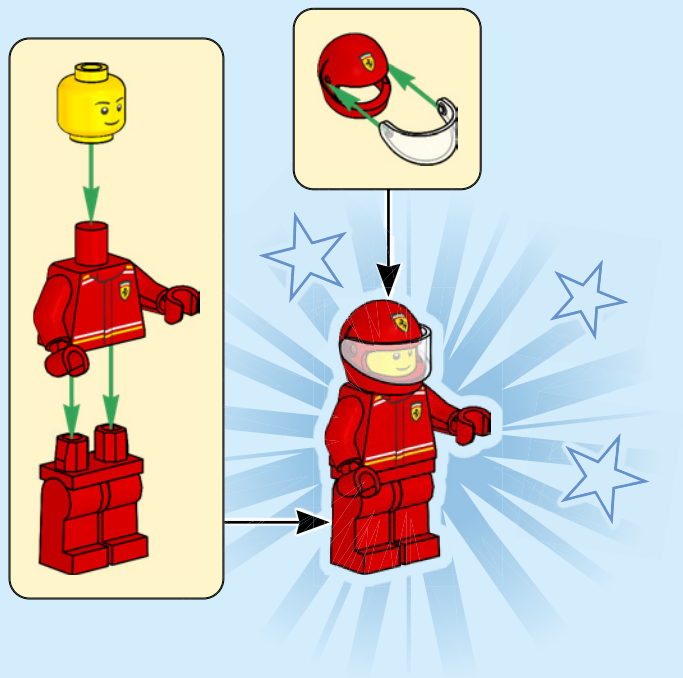



1x

1

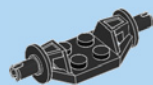
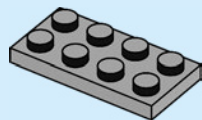

1x

2

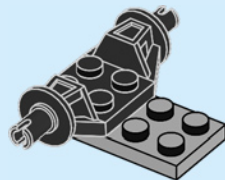





1x



1x

3

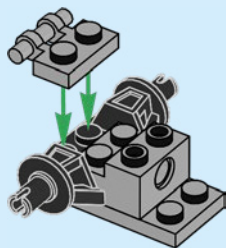

2x

4

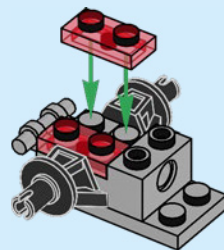



1x

5

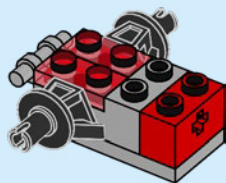

1x

6

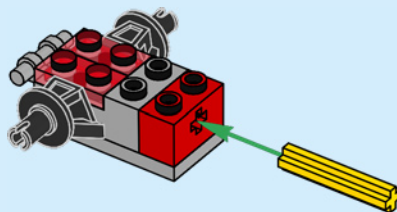

3

1:1

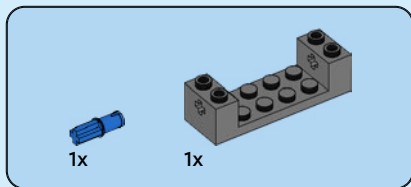

7

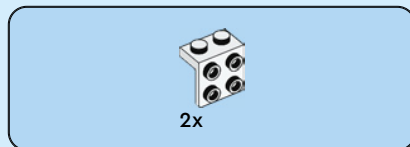
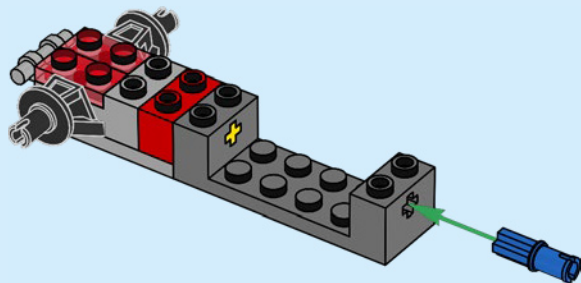

8

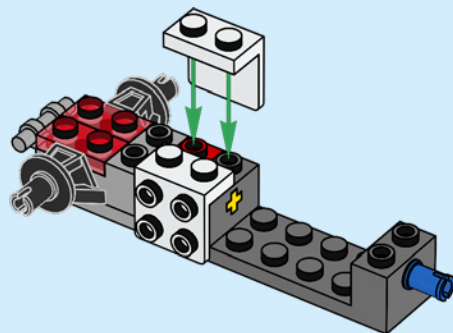

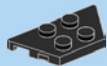

1x

9

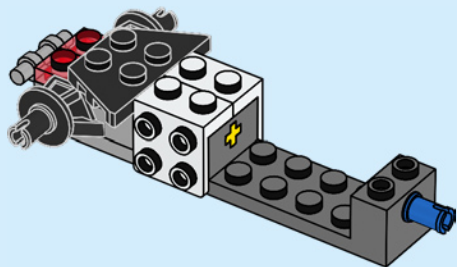

2x

10

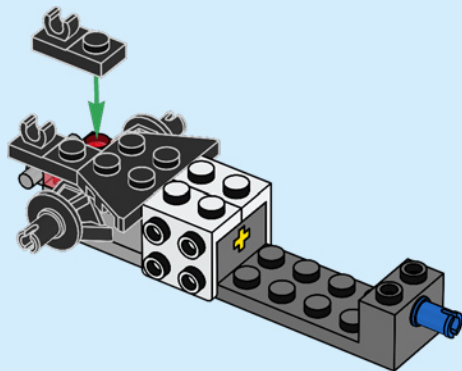



1x

11

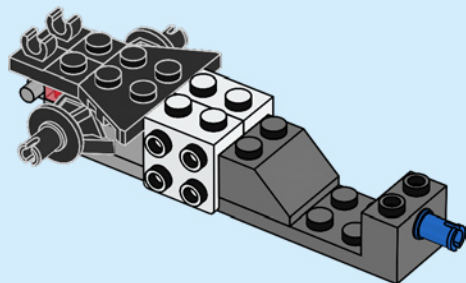

1x

12

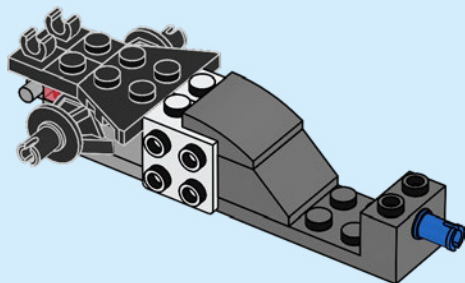



2x

13

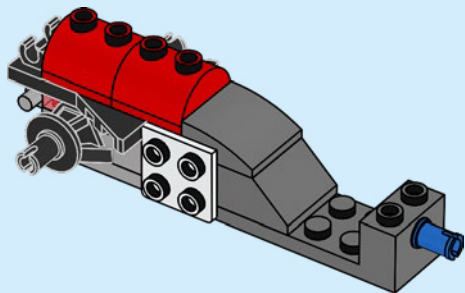

1x

14

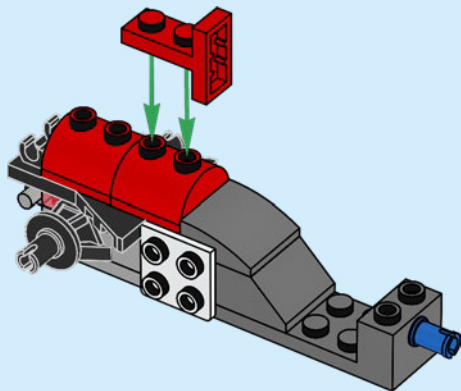



1x

15

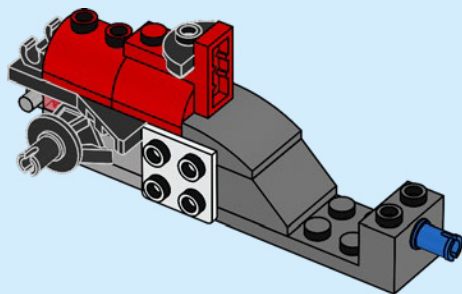

1x

16

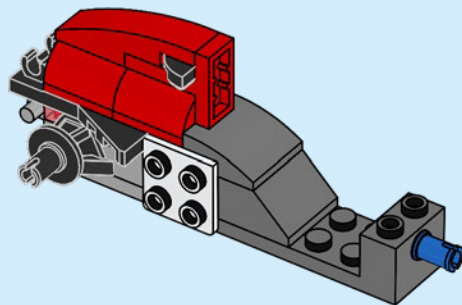



1x

17

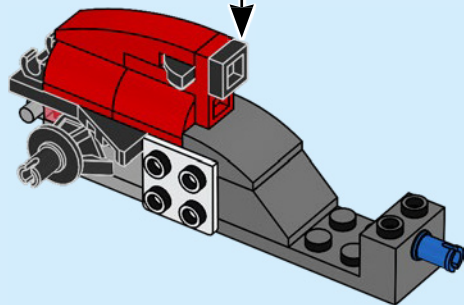



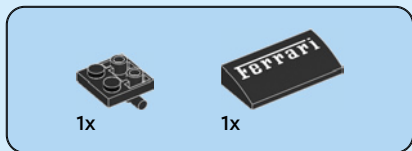

18

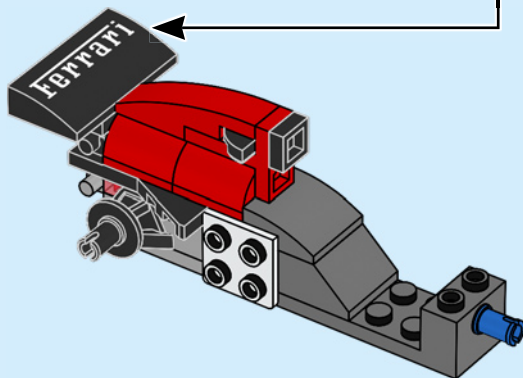
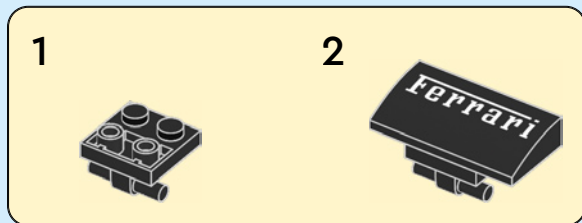

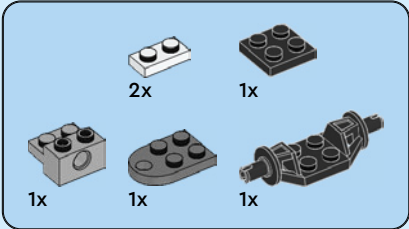

19

1

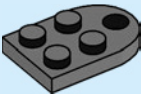

2

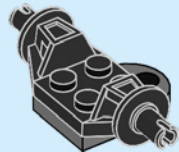

3

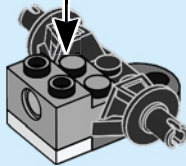
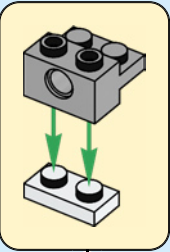

4

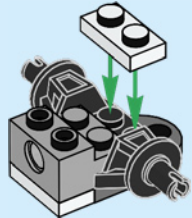

5

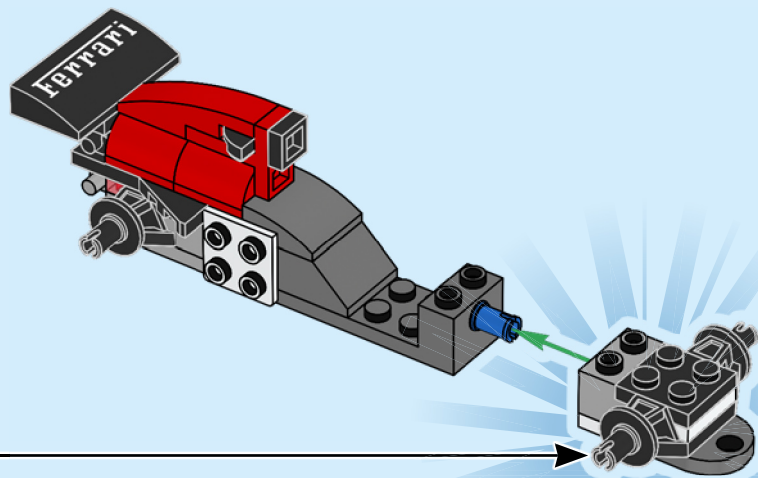
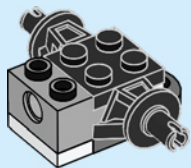



2x

20

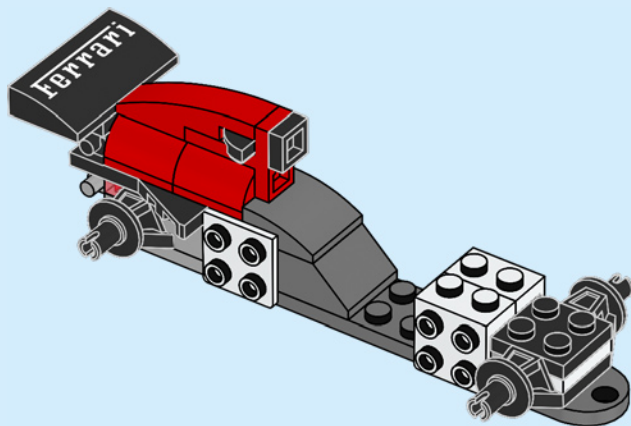



1x

21

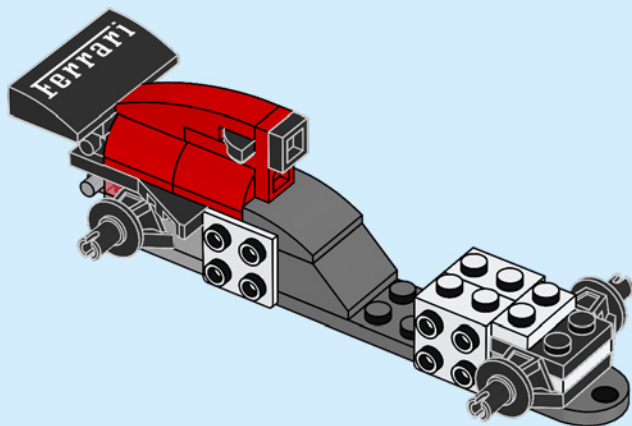



1x

22

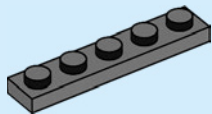

1x

23

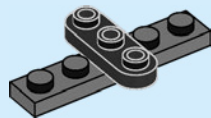



1x



1x

24

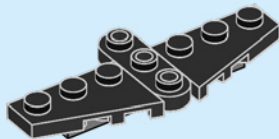

1x

25

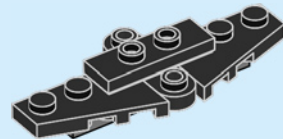



2x

26

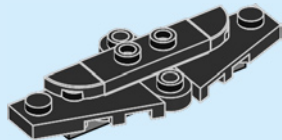

3x

27

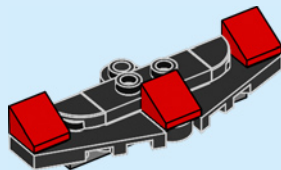





1x

28

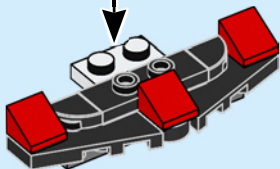
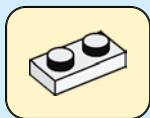

1x

29

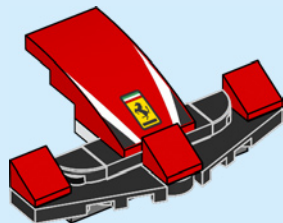

30

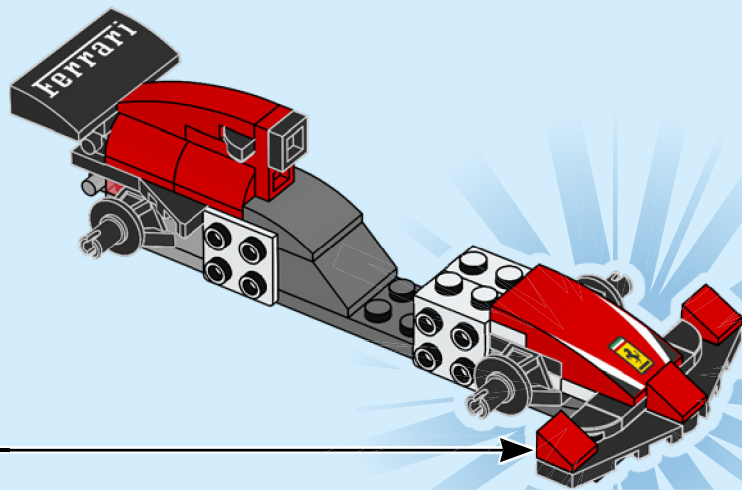



1x



1x

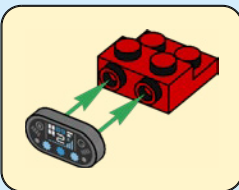

31

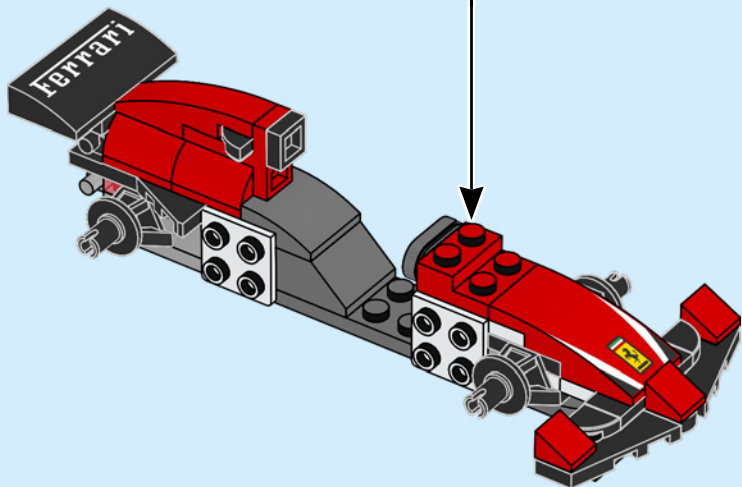

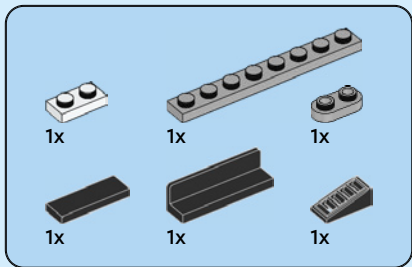

32

1

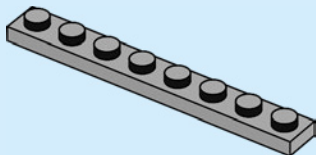

2

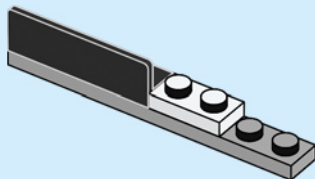

3

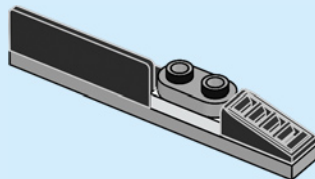

4

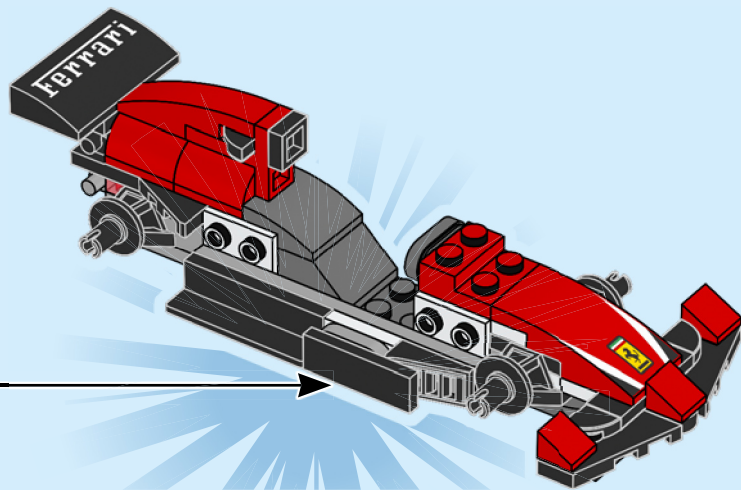
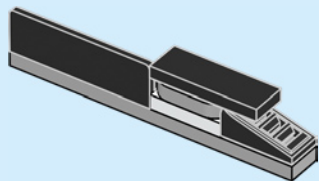



1x

33

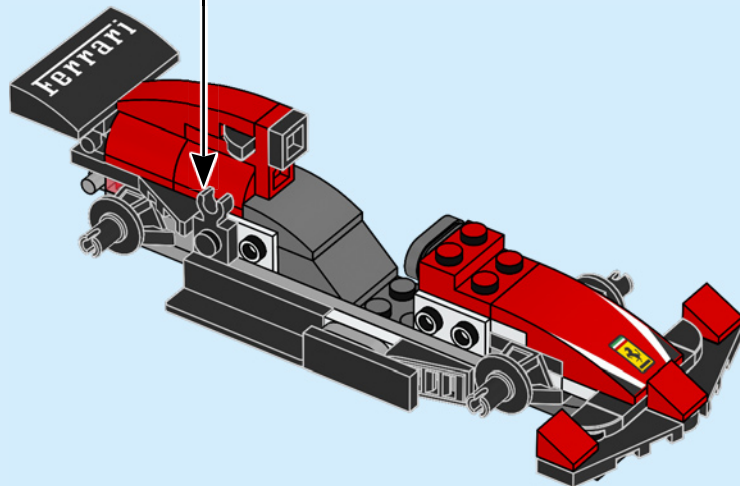



1x

34

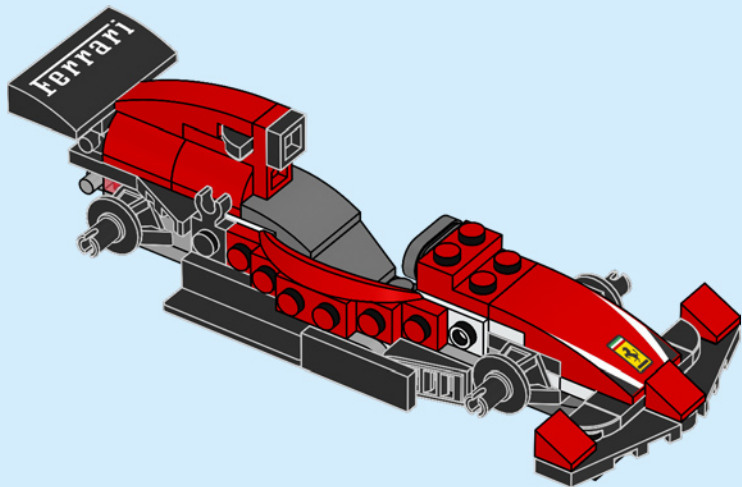



1x

35

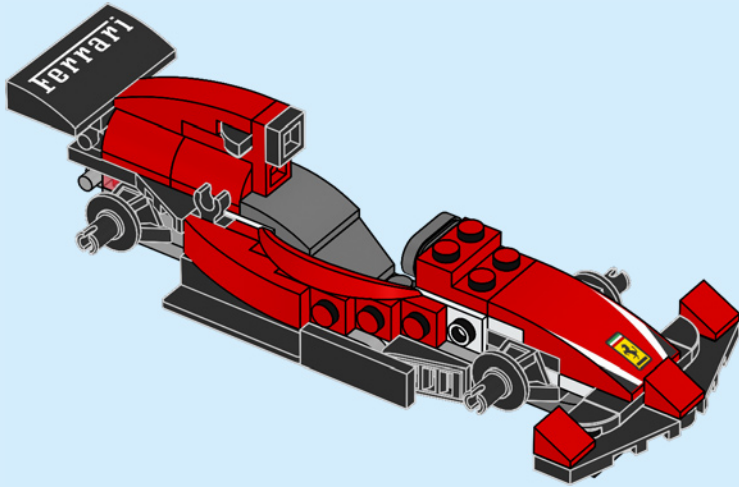





1x



1x

# 36

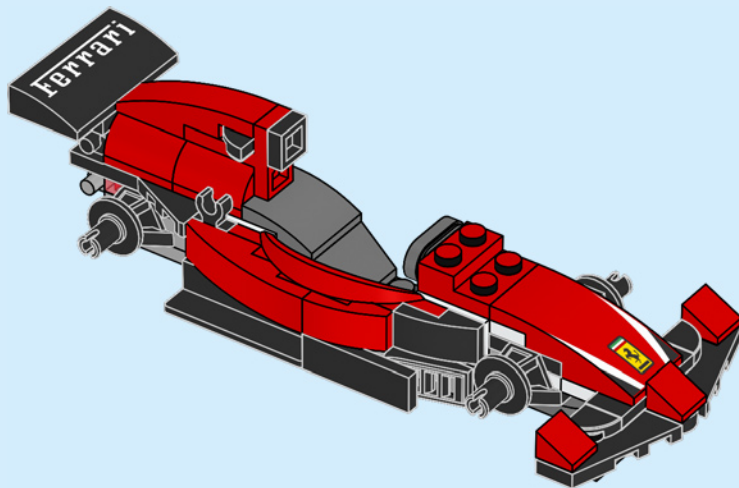

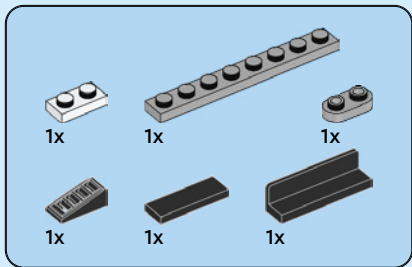

37

1

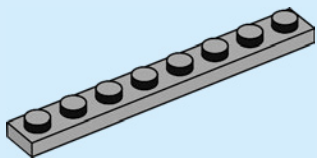

2

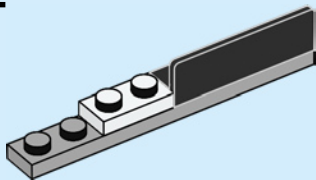

3

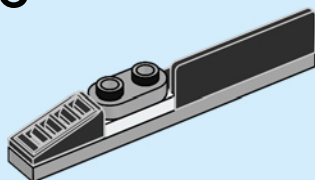

4

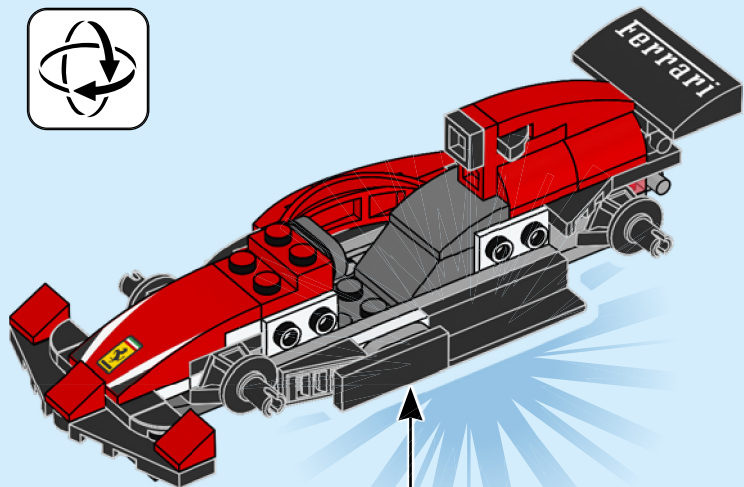
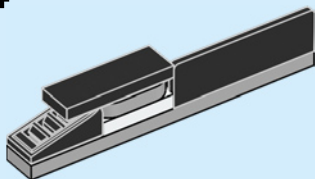



1x

38

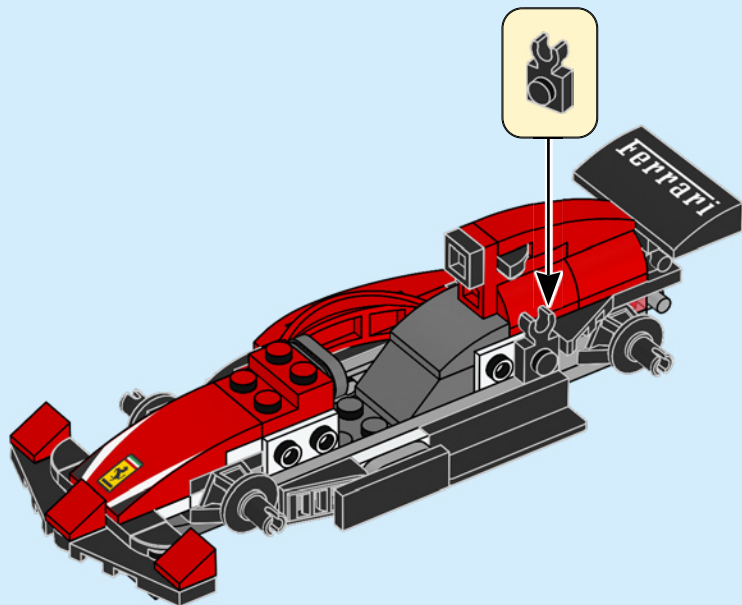



1x

39

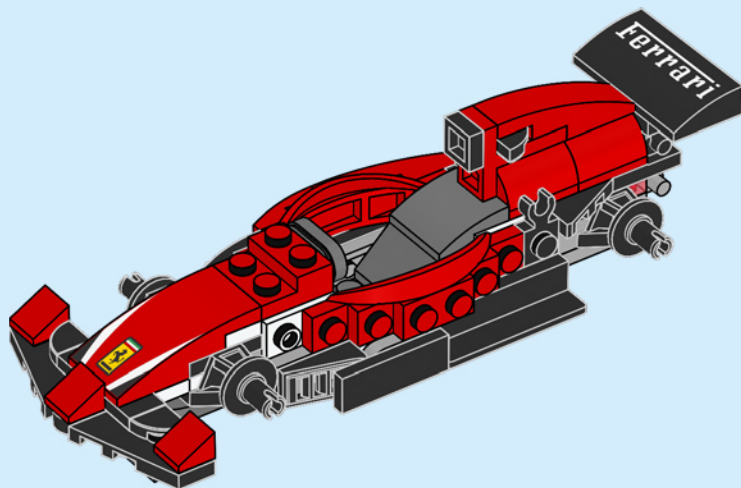



1x

40

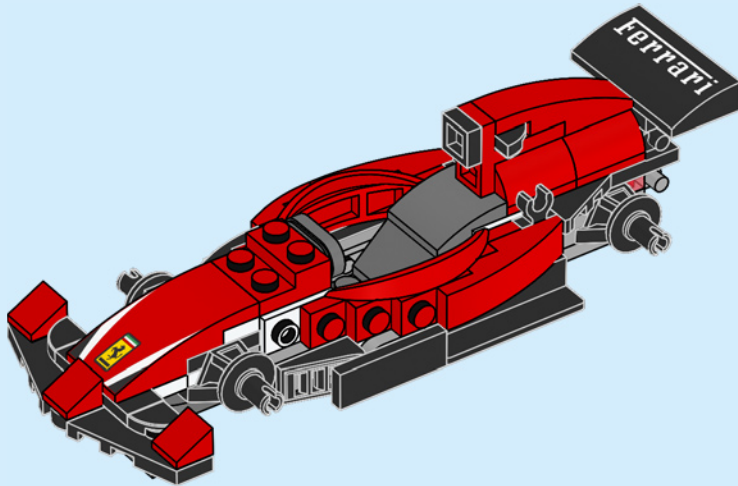



1x



1x

41

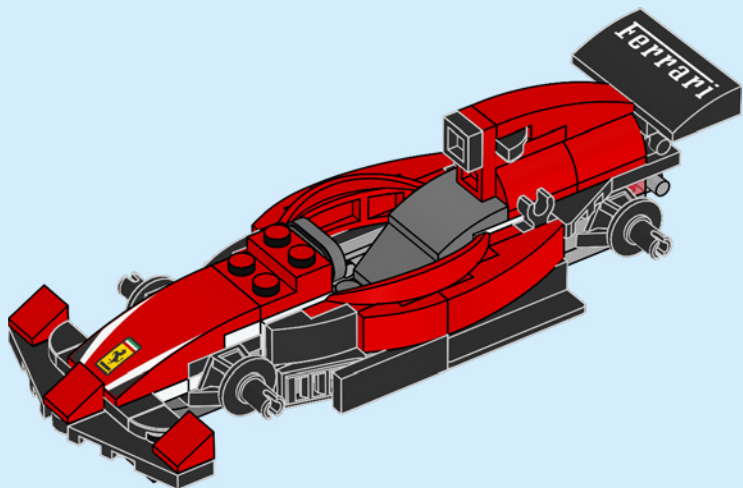

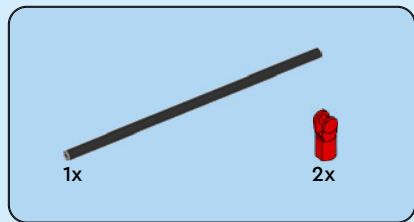

42

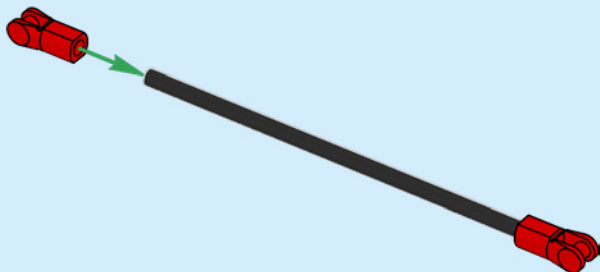



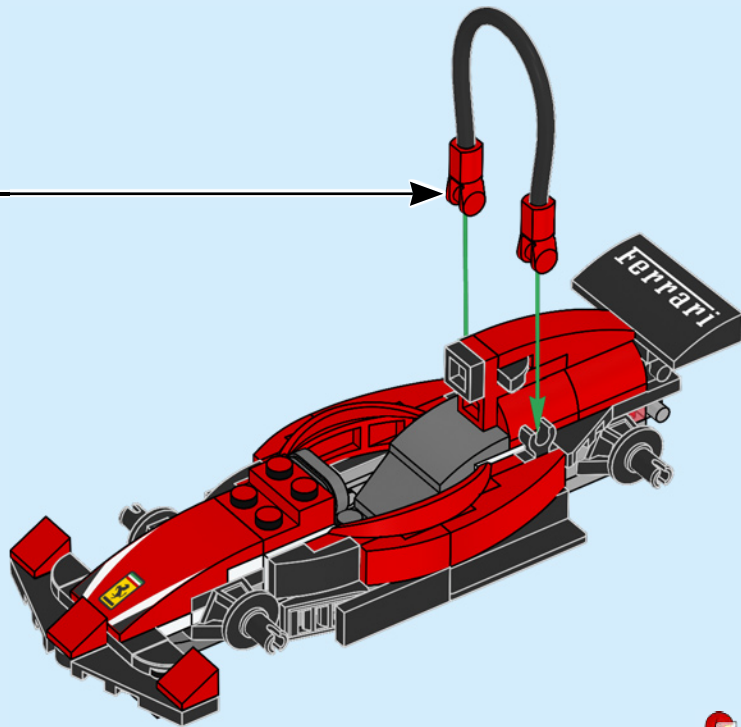



43

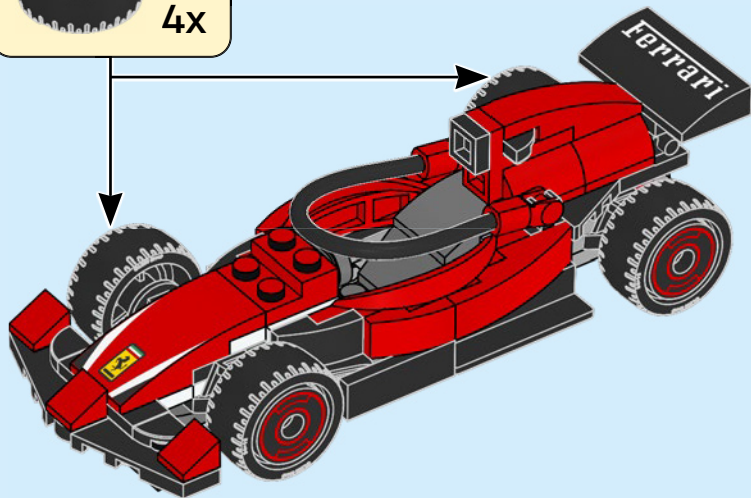
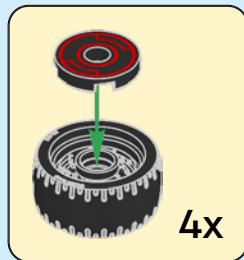

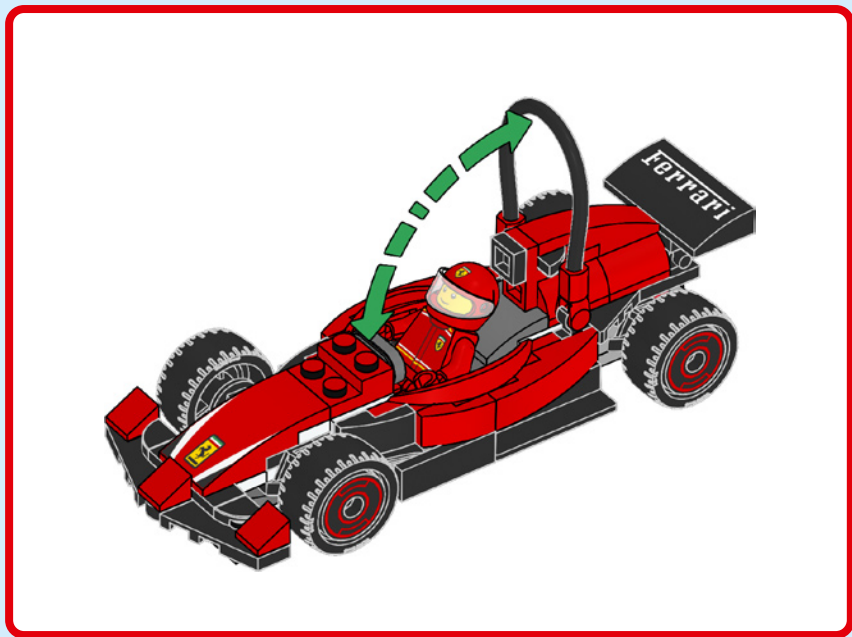

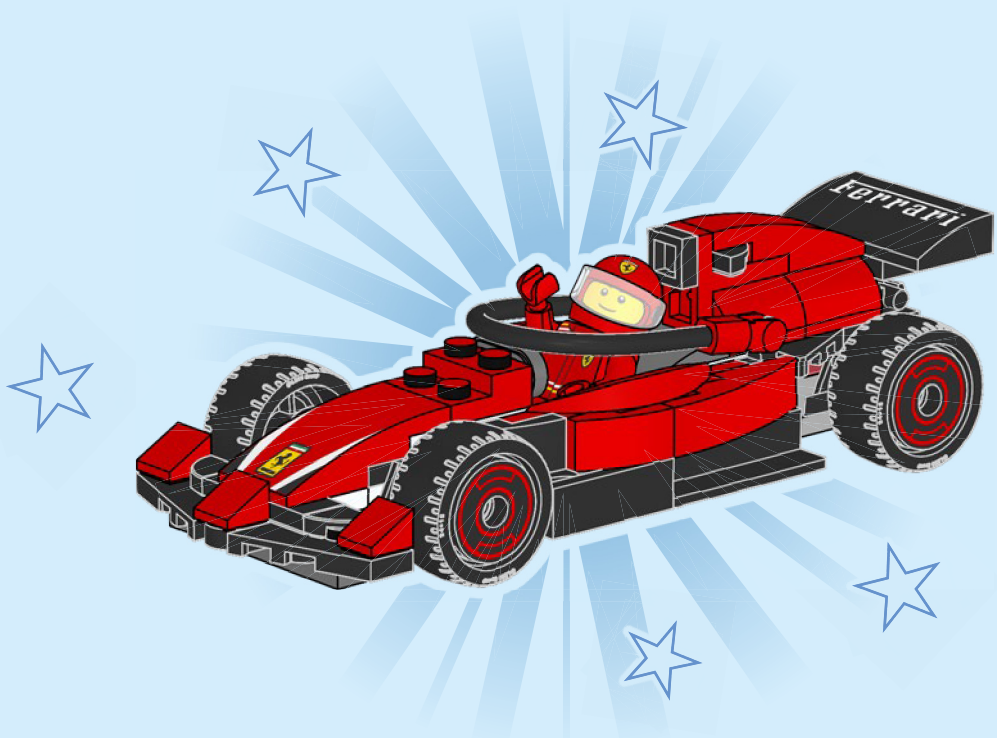



# CITY



60443



60445



60442



60464



60444



Formula 1.



# CITY



60447



60460



60454



60459



60458



**Rebuild  
the  
World™**





LEGO and the LEGO logo are trademarks of the LEGO Group. ©2025 The LEGO Group. 6557533

Produced under license of Ferrari S.p.A. The name FERRARI, the PRANCING HORSE device, all associated logos and distinctive designs are property of Ferrari S.p.A.  
The body designs of the Ferrari cars are protected as Ferrari S.p.A. property under design, trademark and trade dress regulations.

The F1 logo, FORMULA 1, F1, GRAND PRIX and related marks are trademarks of Formula One Licensing BV, a Formula 1 company. All rights reserved.

OFFICIAL LICENSEE OF FORMULA 1®