



SONIC™

THE HEDGEHOG

77001



LEGO® Builder



LEGO.com/sustainable-packaging



 ^{FR} **DONNEZ**
OU
RECYCLEZ

 OU  OU 

ASSOCIATION MAGASIN DÉCHÈTERIE

Adresses sur quefairedemesdechets.fr

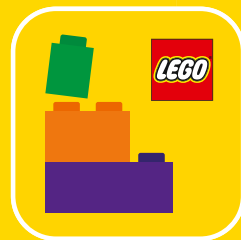

Q LEGO® Builder

BUILDER



Apple and the Apple logo are trademarks of Apple Inc., registered in the U.S. and other countries and regions. App Store is a service mark of Apple Inc. Google Play and the Google Play logo are trademarks of Google LLC. Tencent and the Tencent logo are trademarks of Tencent Inc.

Q [LEGO.com/devicecheck](https://www.lego.com/devicecheck)

EN Ask parents' permission before going online | DE Eltern um Erlaubnis bitten, bevor du online gehst | FR Demande l'autorisation d'un parent avant d'aller en ligne | IT Chiedi il permesso ai tuoi genitori prima di andare online | ES Pídeles permiso a tus papás antes de conectarte a Internet | PT Pede autorização aos pais antes de acederes online | ZH 上网前应先征得父母的同意 | PL Poproś rodziców o zgodę, zanim wejdiesz do Internetu | CS Než půjdeš na internet, požádej rodiče o svolení | SK Skôr než pôjdeš na internet, vypýtaj si povolenie od rodičov | HU Kérj szülői engedélyt, mielőtt online csatlakoznál! | RO Cere permisiunea părinților înainte de a te conecta online | BG Поискайте разрешение от родител, преди да влезете онлайн | LV Pirms došanās tiešsaistē palūdz atļauju vecākiem | ET Enne Interneti kasutamist küsi vanematelt luba | LT Prieš prisijungdami prie interneto, atsiklauskite tėvų

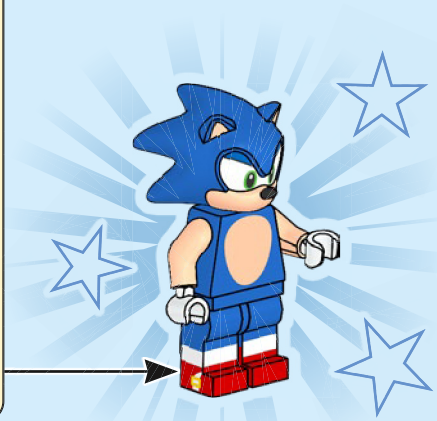
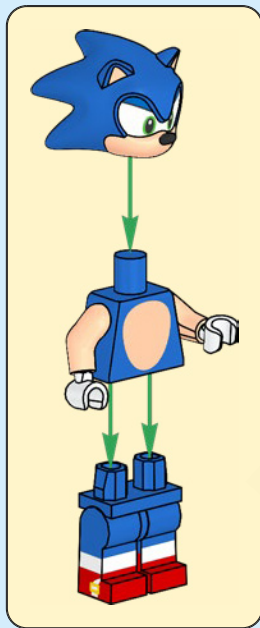

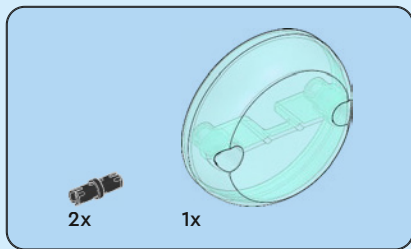

2

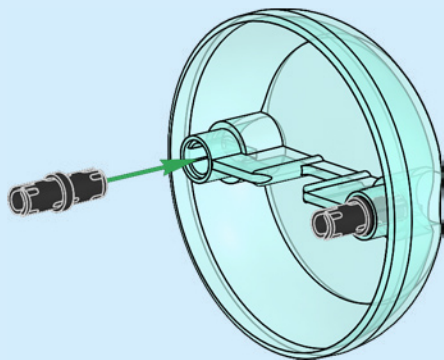

3

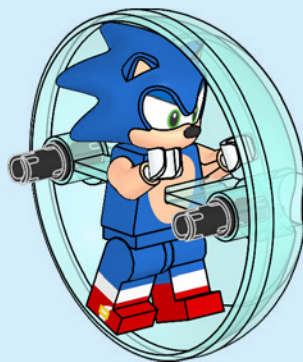

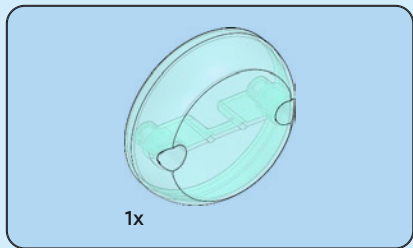

4

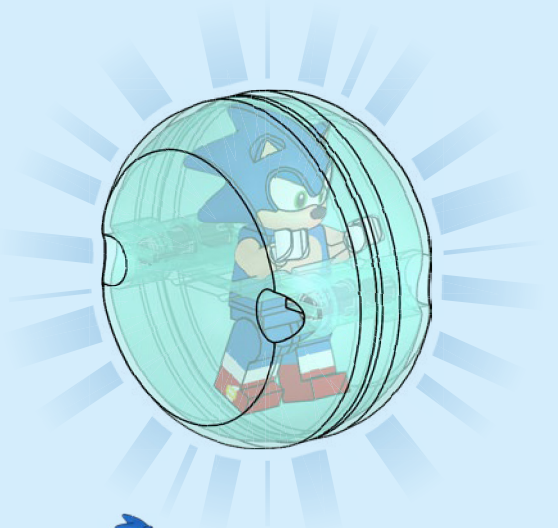

6

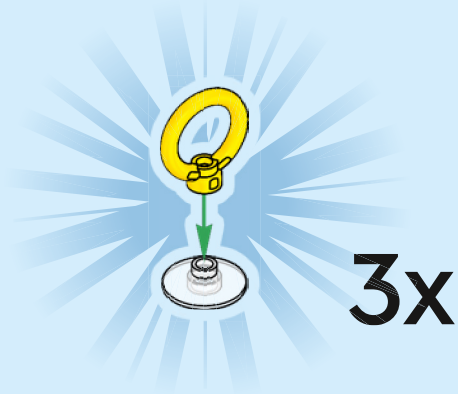
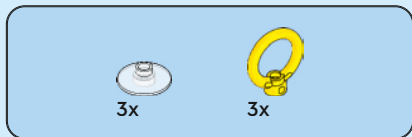
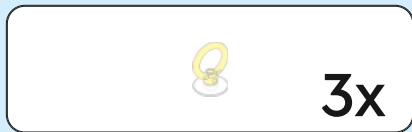

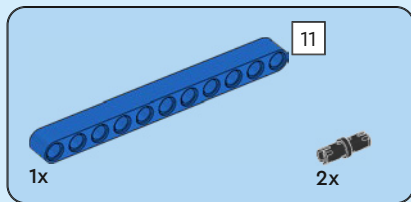
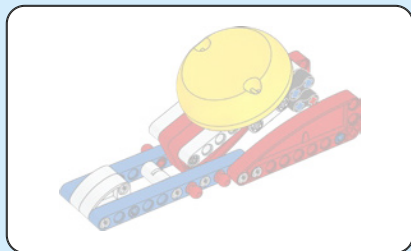

1

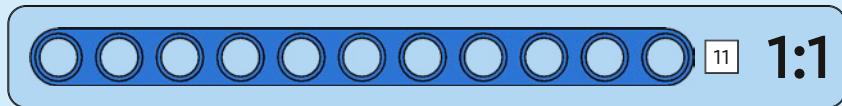
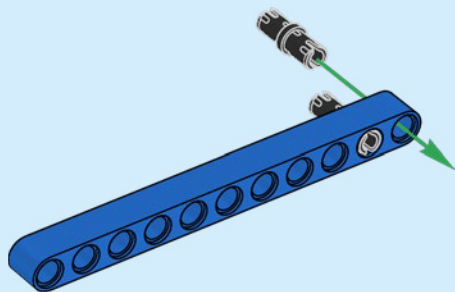

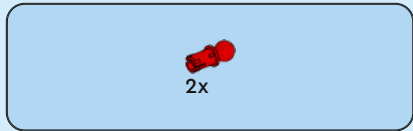

2

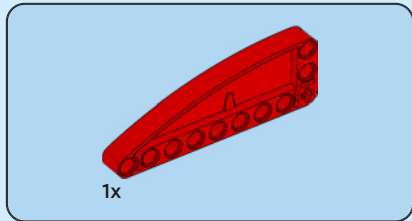
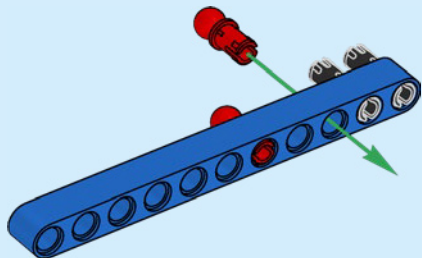

3

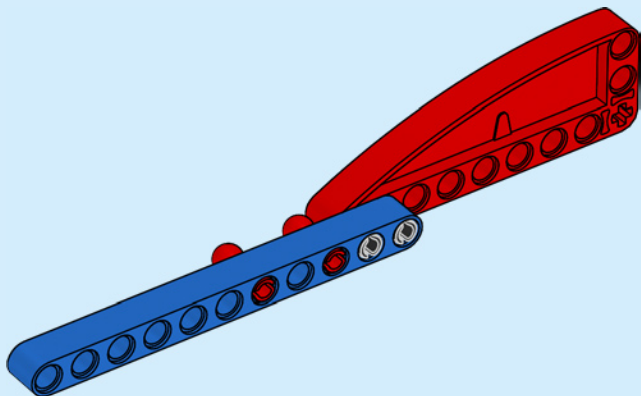

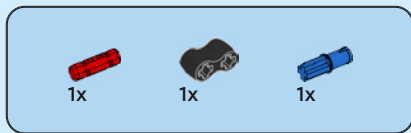

4

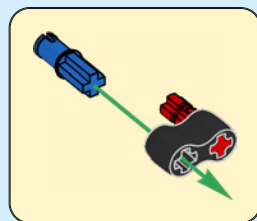
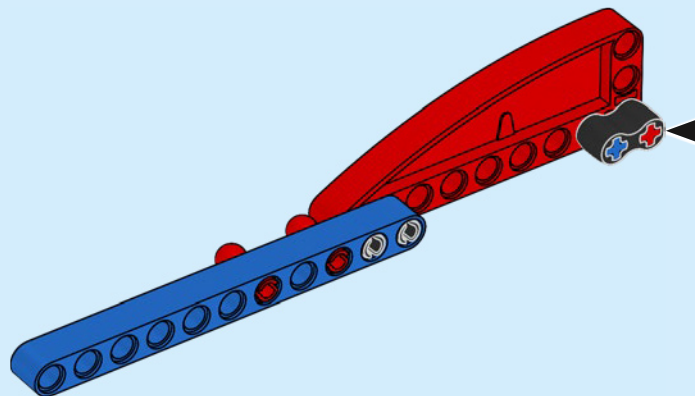

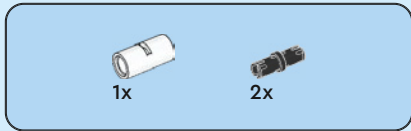

5

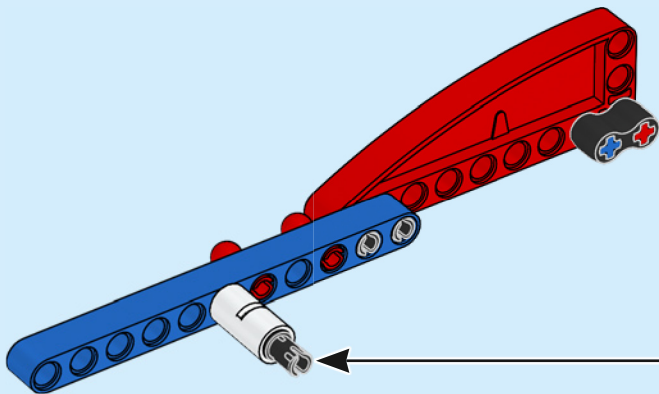
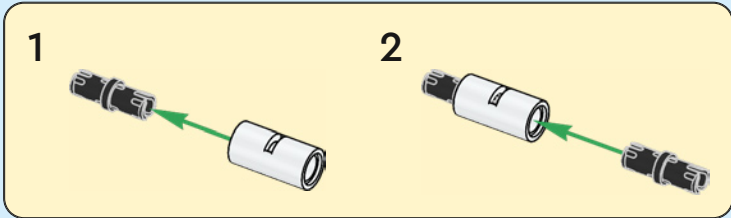

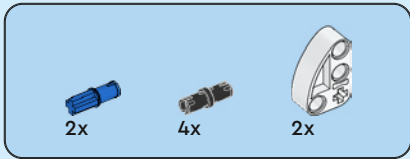

6

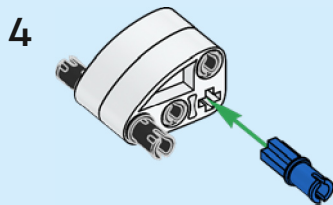
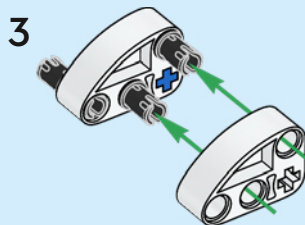
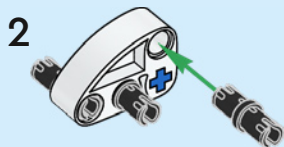
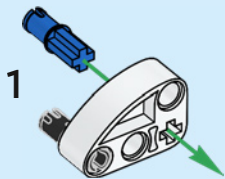

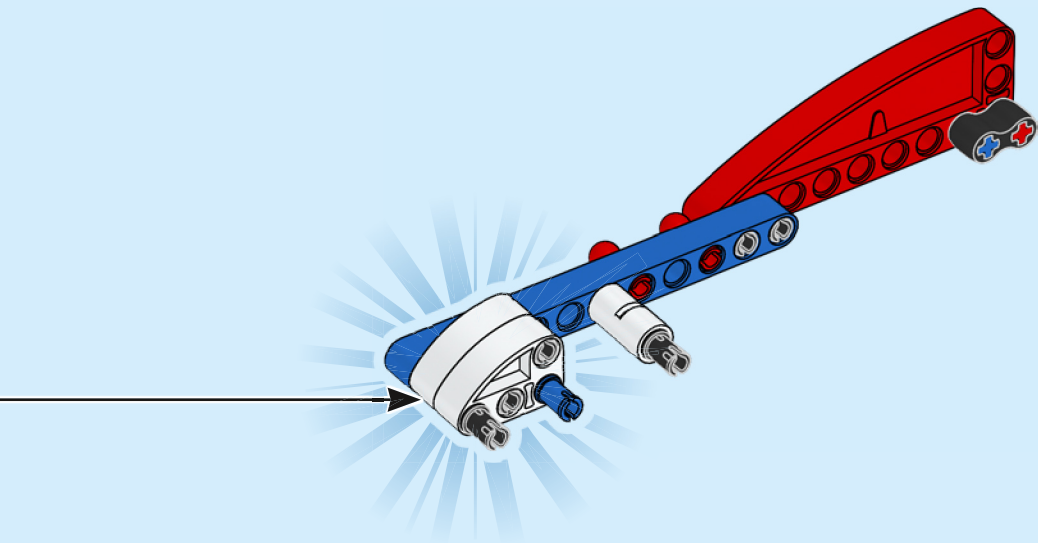

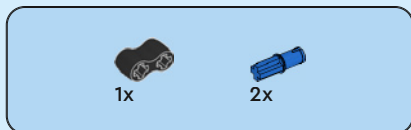
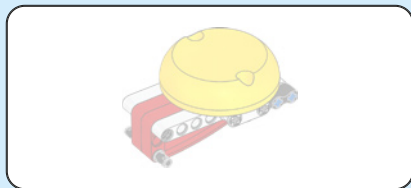

7

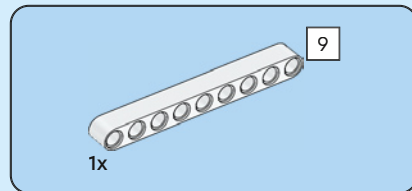
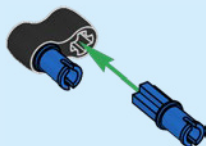

8

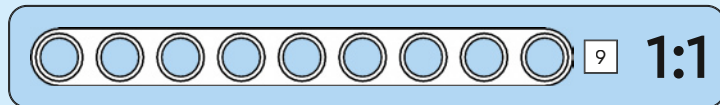
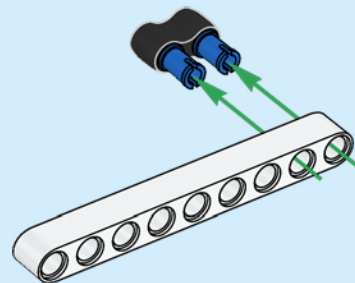

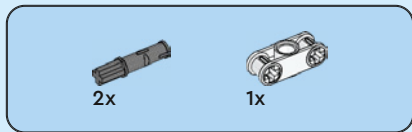

9

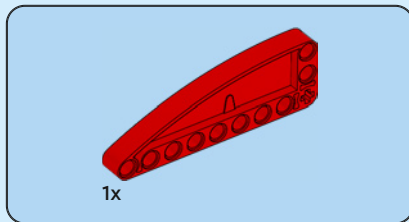
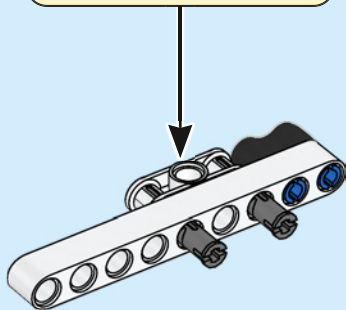
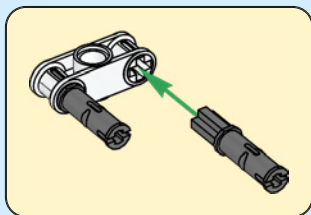

10

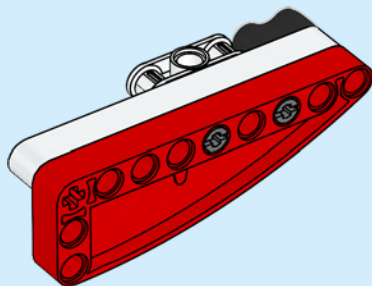

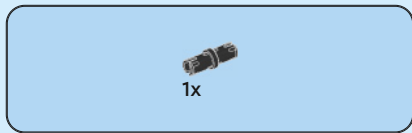

11

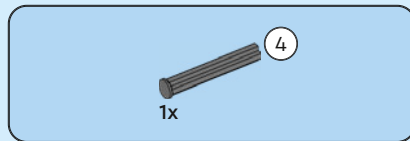
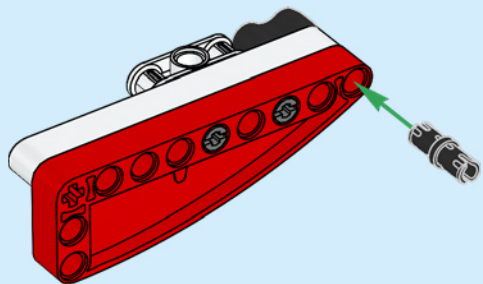

12

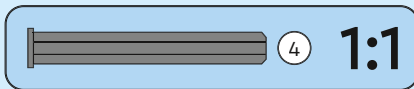
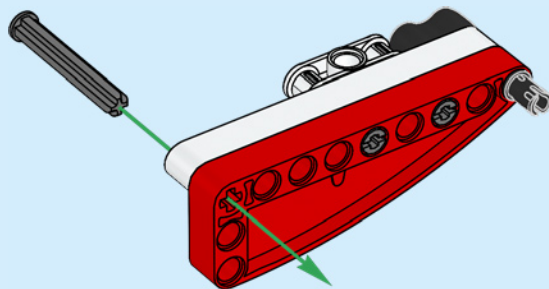

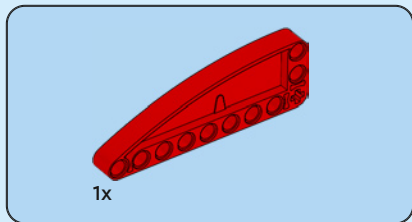

13

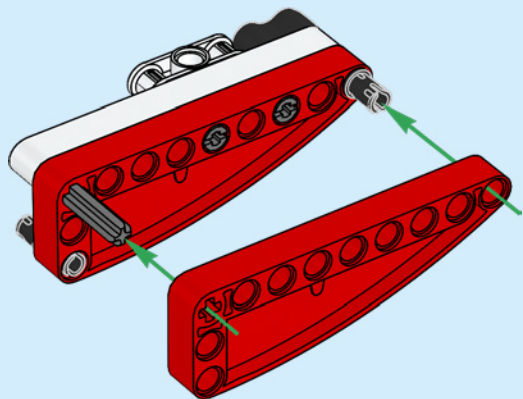

14

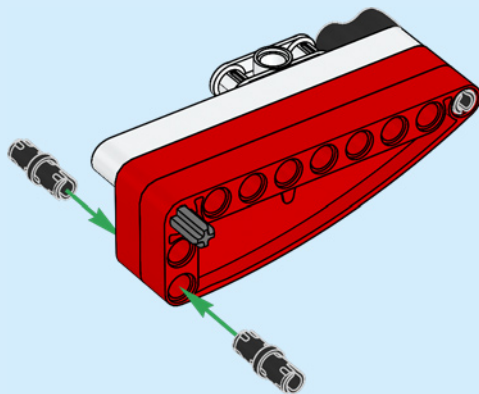

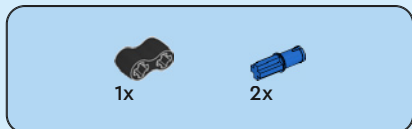
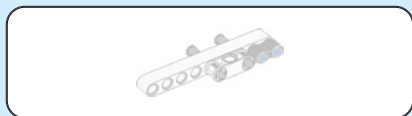

15

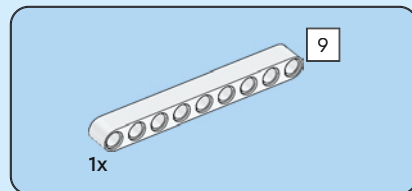
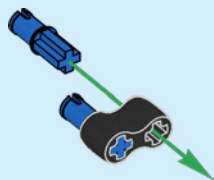

16

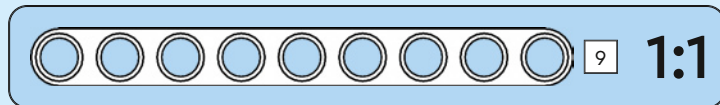
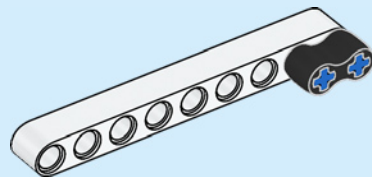

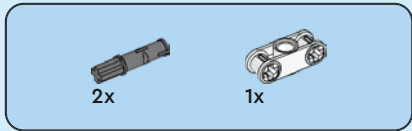

17

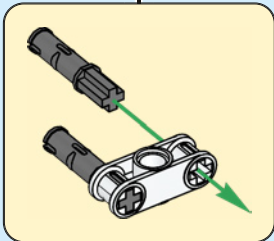
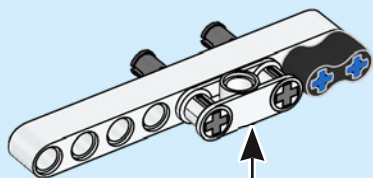

18

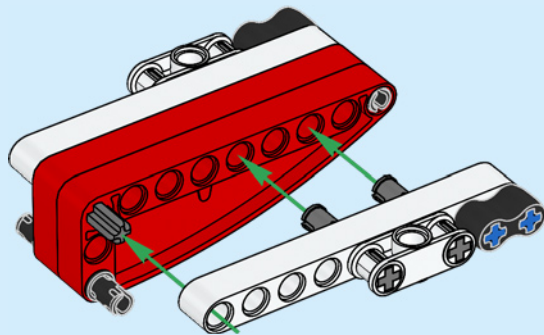

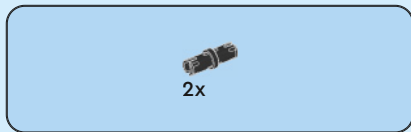

19

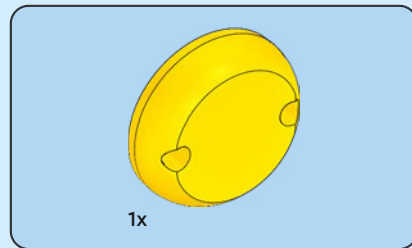
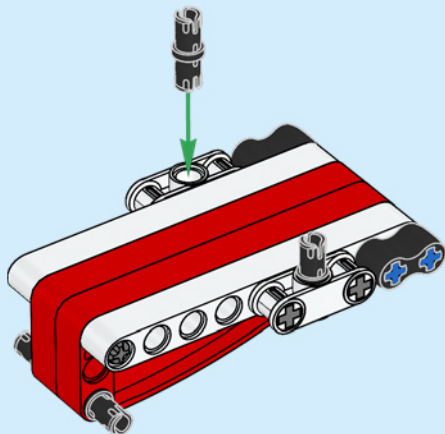

20

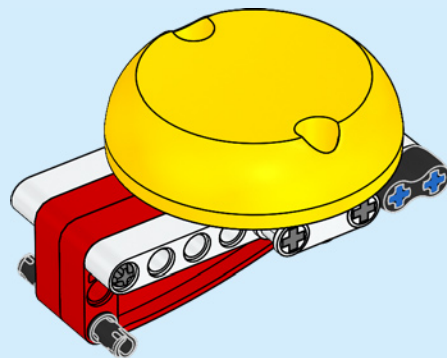

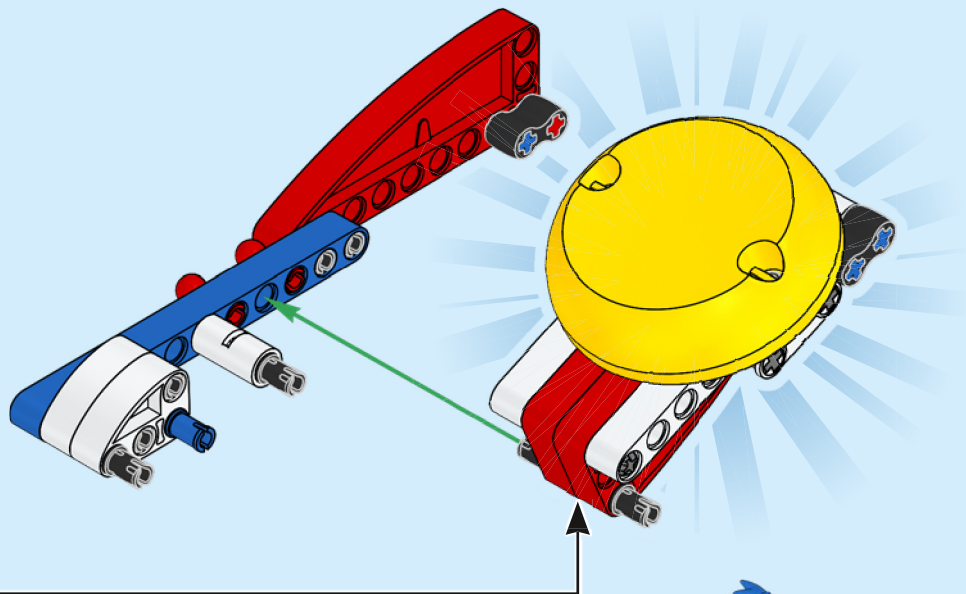

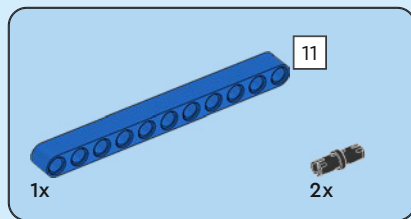

22

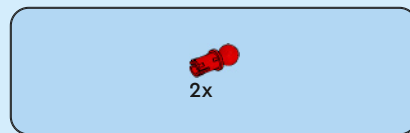
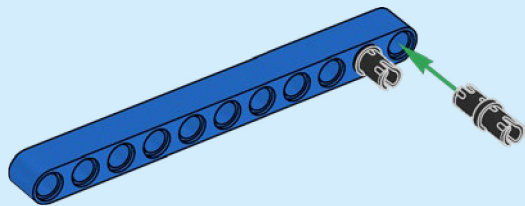

23

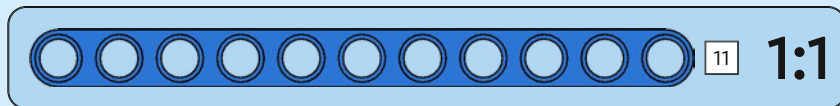
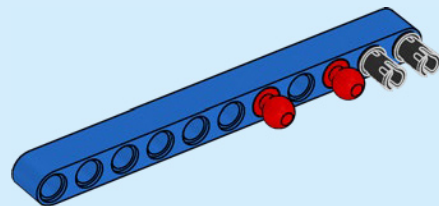

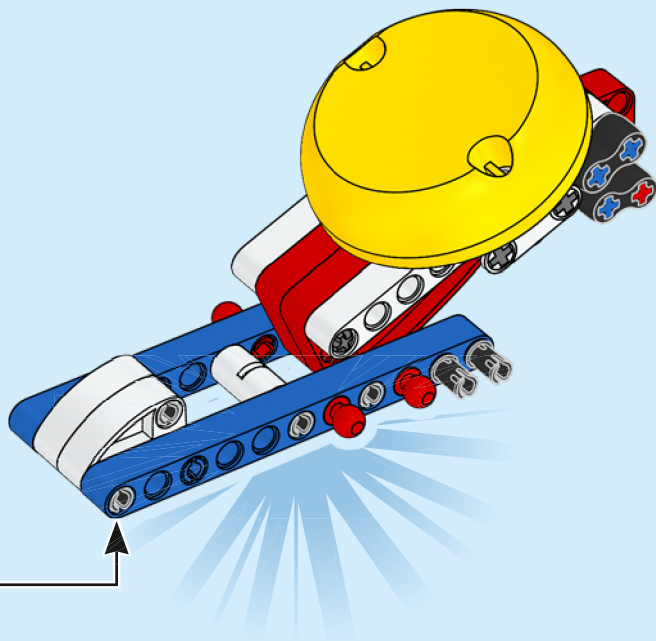

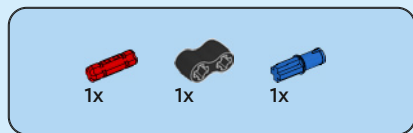

25

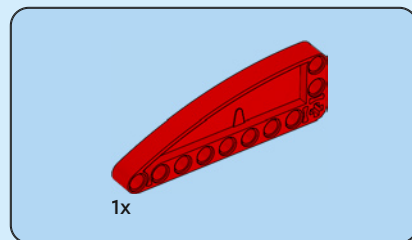
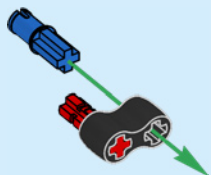

26

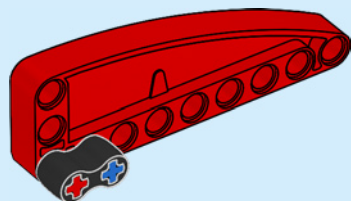

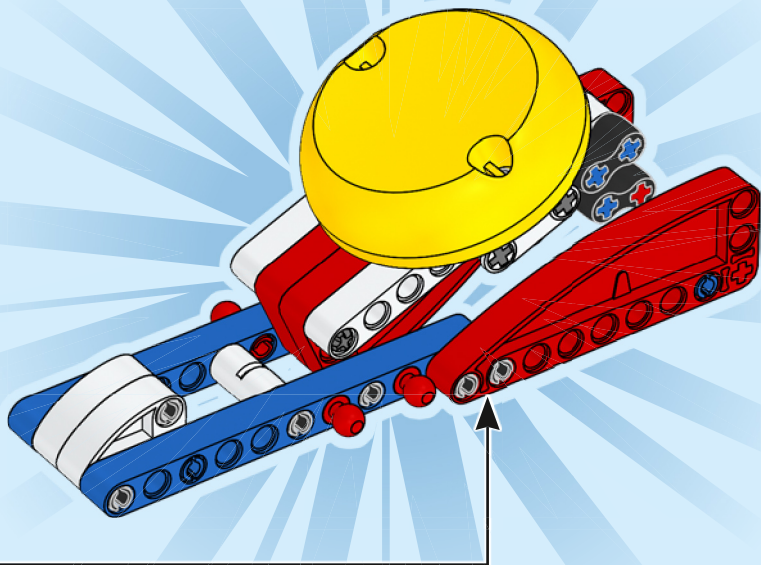

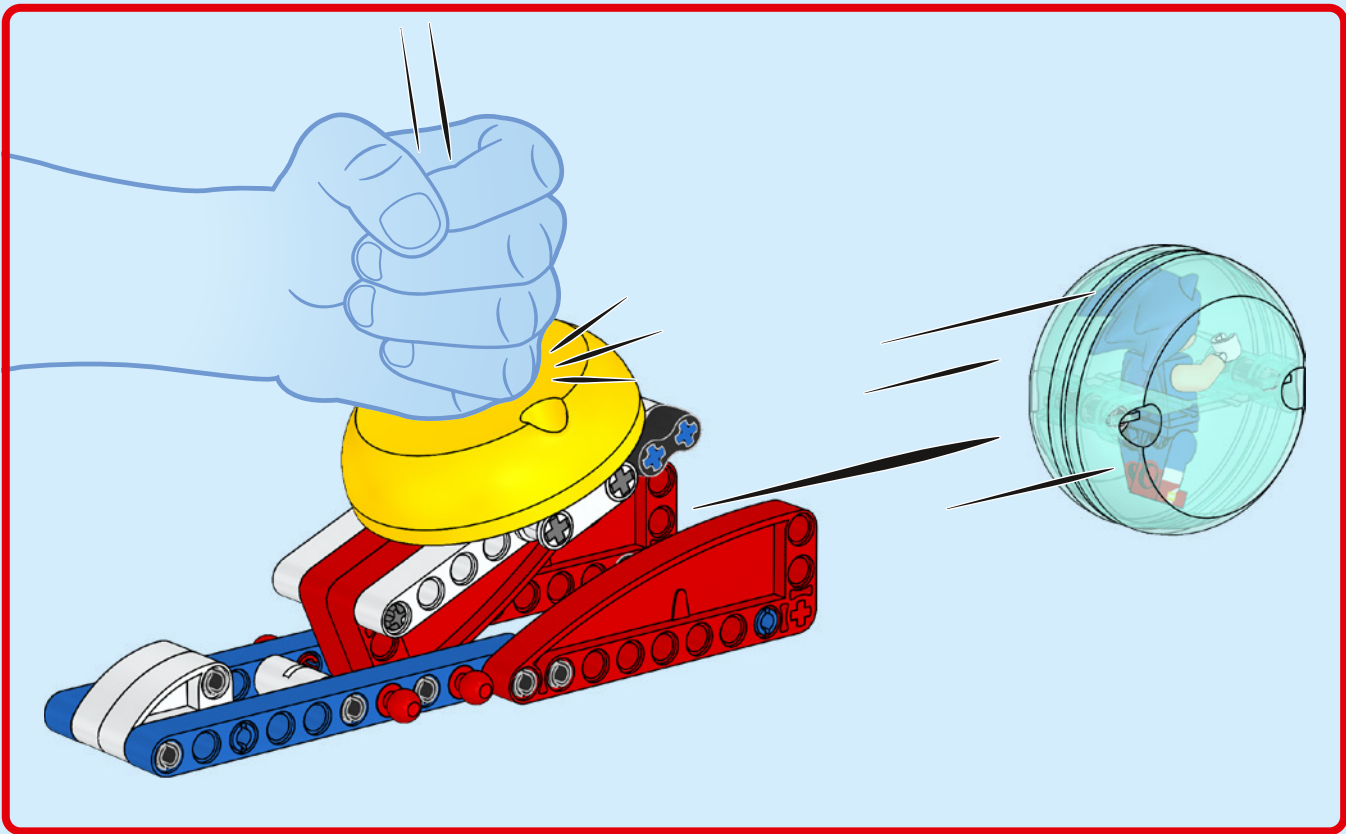

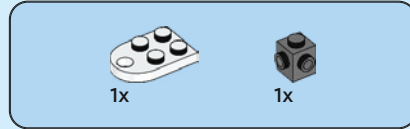
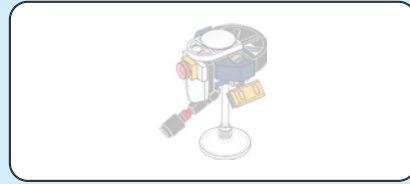

1

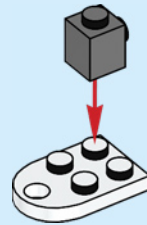



3x

2

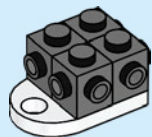

1x

3

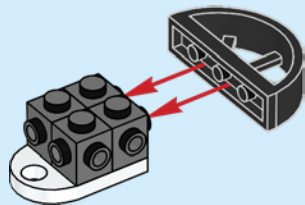

2x

4

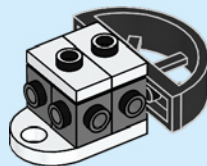

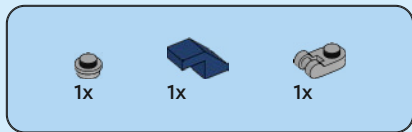

5

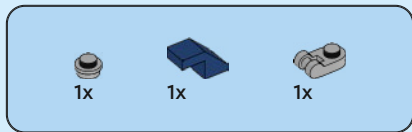
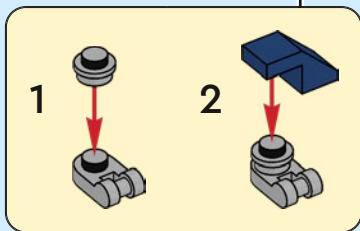
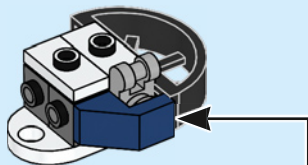

6

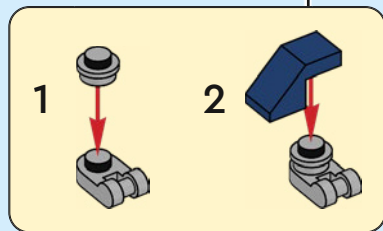
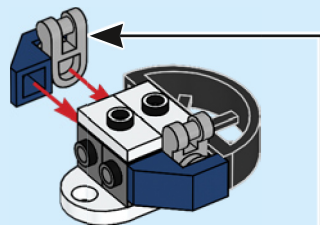



2x



1x

7

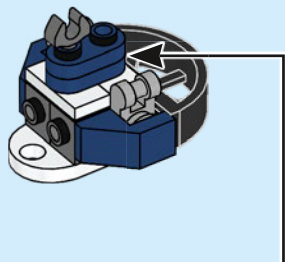

1



2

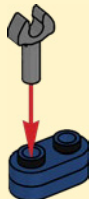

1x



1x



1x



1x



1x

8

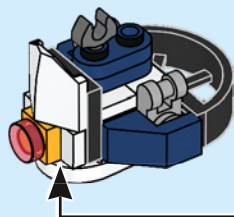

1

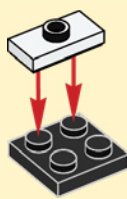

2



3

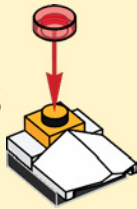



2x



2x

9

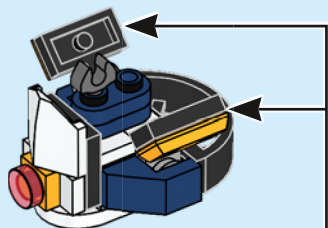

2x



1x



1x



1x

10

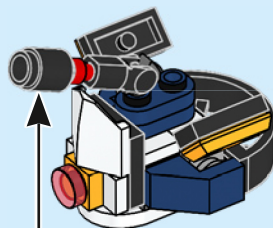

1

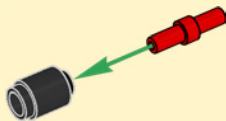

2

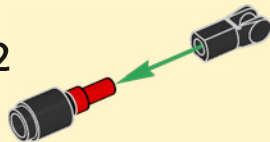

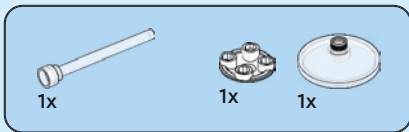

11

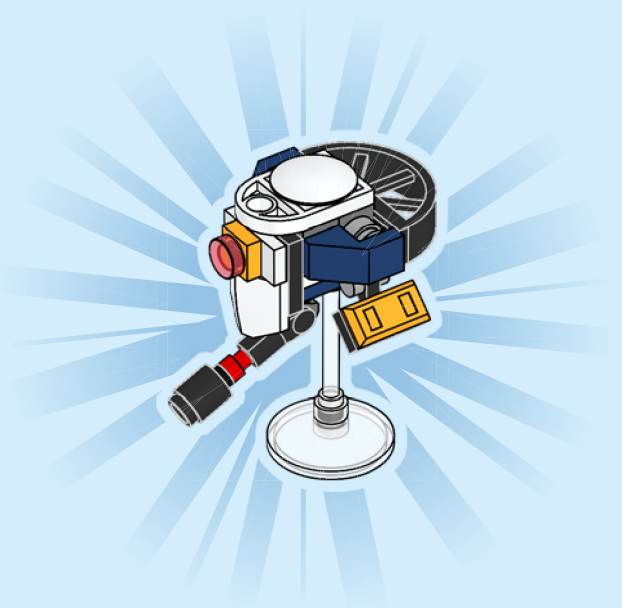
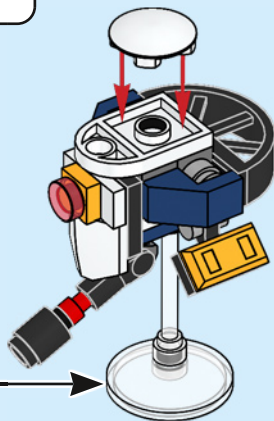
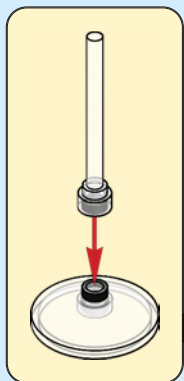

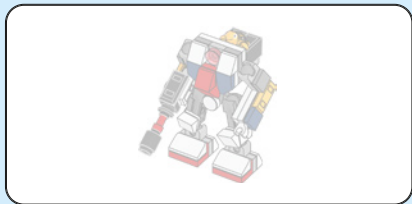

1

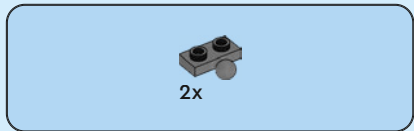
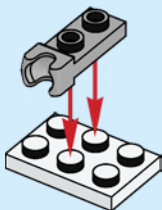

2

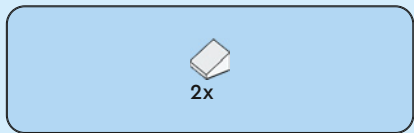
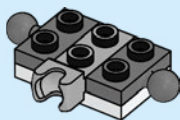

3

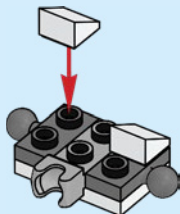



1x



1x

4

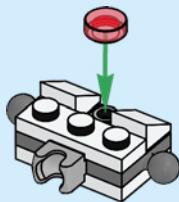

1x



1x

5

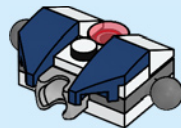

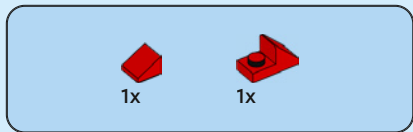

6

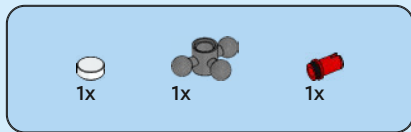
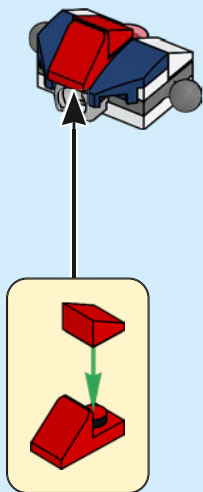

7

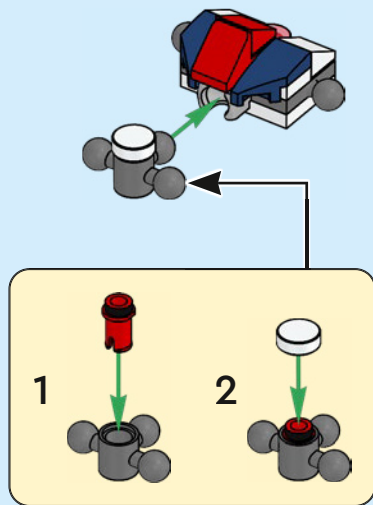



2x



2x



2x



2x

8

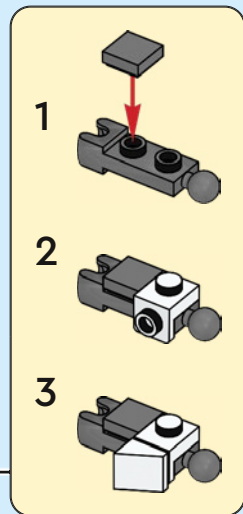
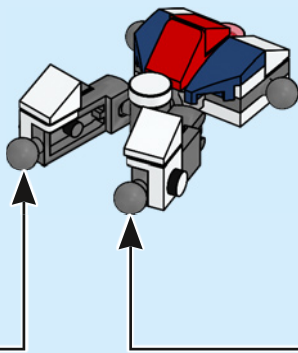
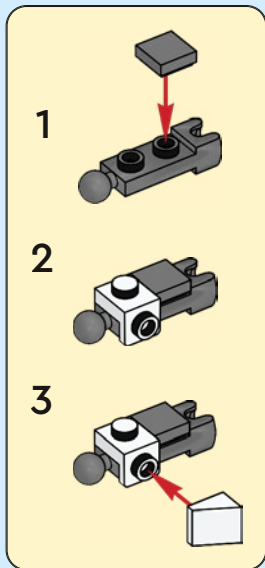



2x



4x



2x



2x

9

1

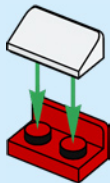

2

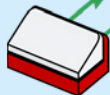

2x

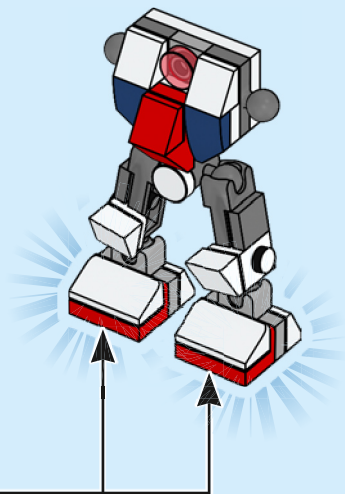
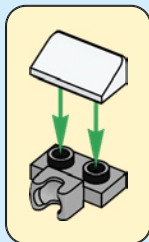

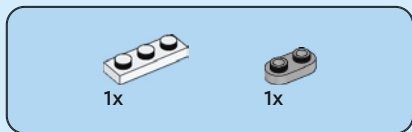
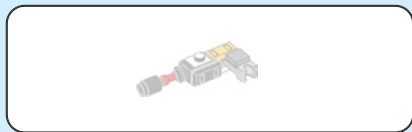

10

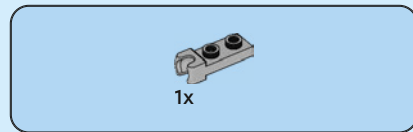
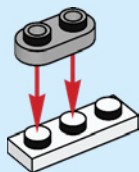

11





1x



1x

12

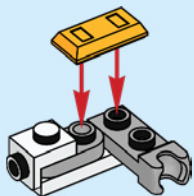

1x



1x

13

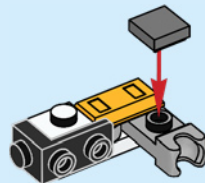



1x



1x

14

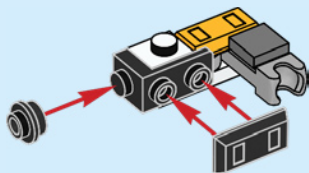

1x



1x

15

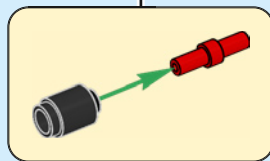
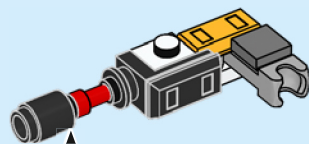

16

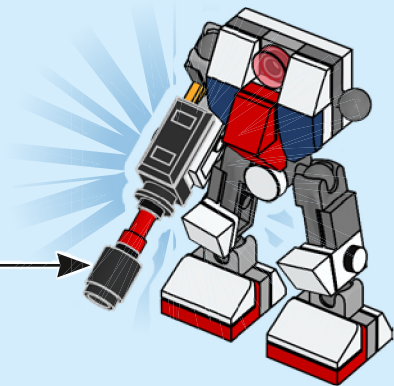

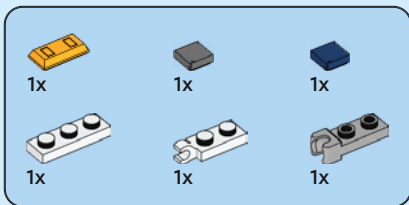

17

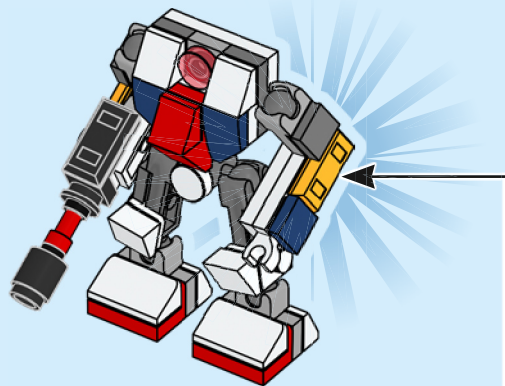

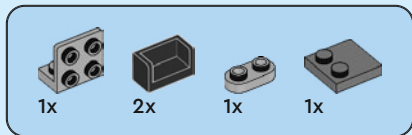

18

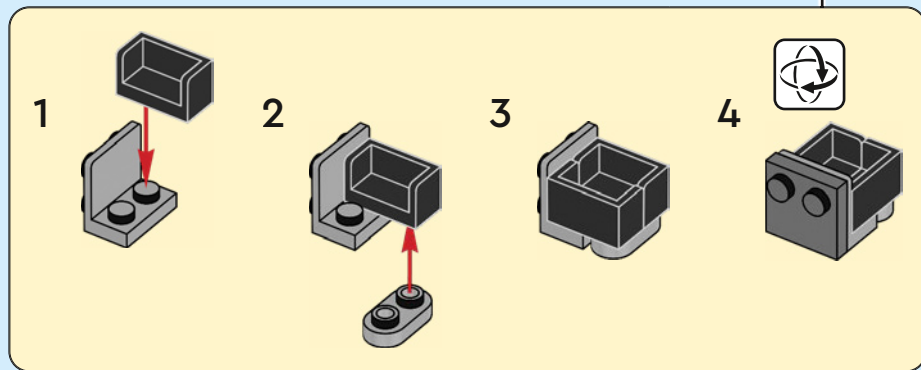
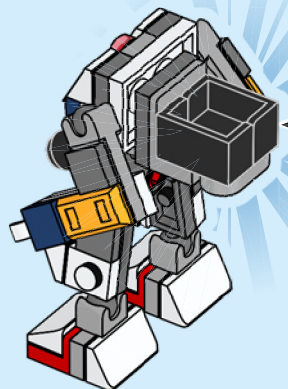



1x

19

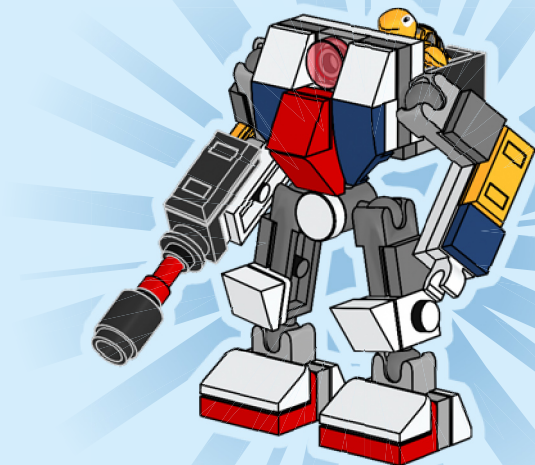
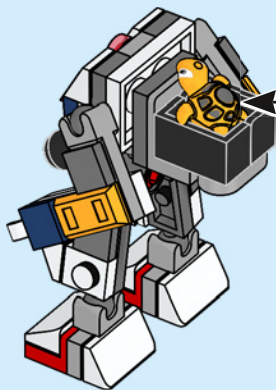

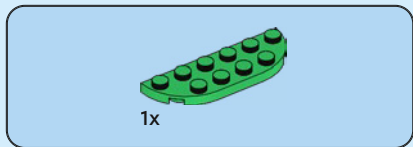

1

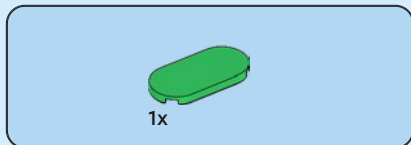
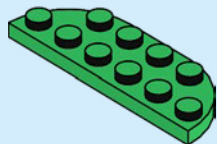

2

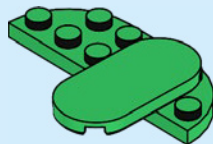

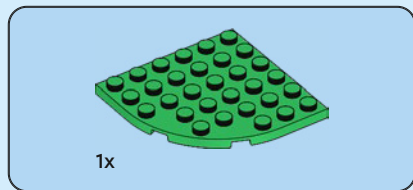

3

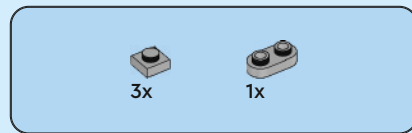
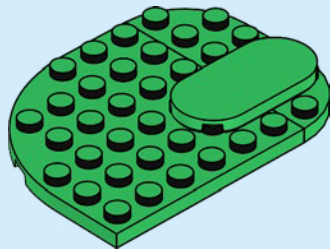

4

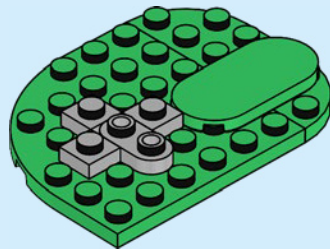



5

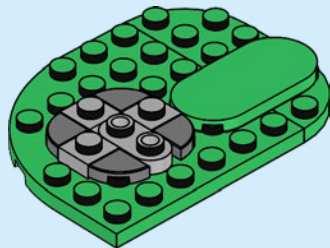

6

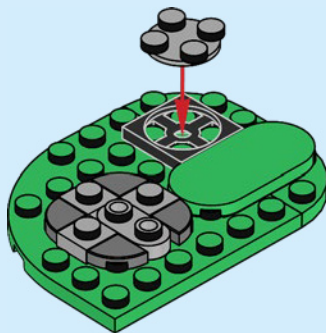



1x

7

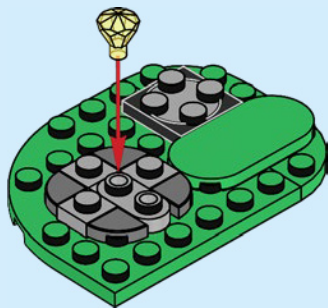

1x



1x

8

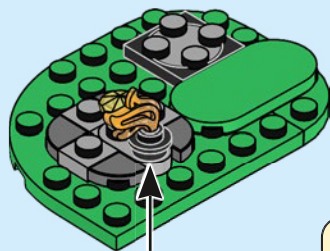



3x

9

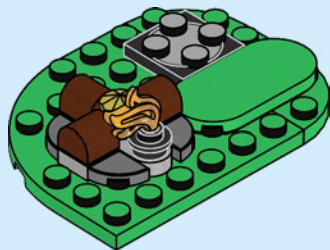

2x



2x

10

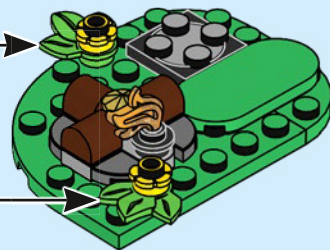
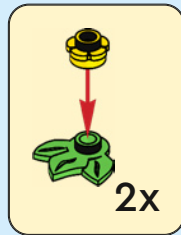

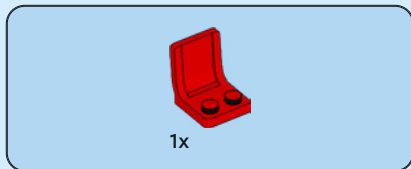

11

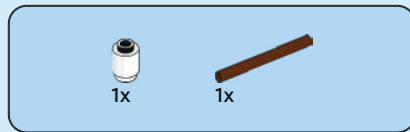

12

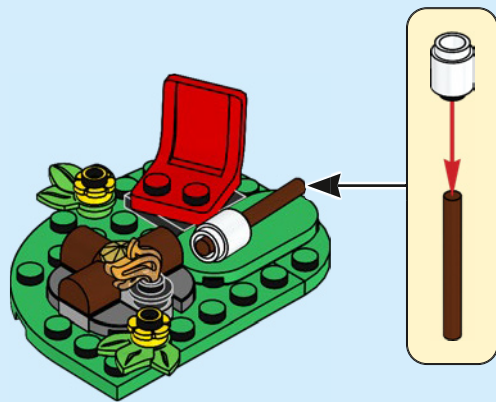







SONIC™

THE HEDGEHOG





©SEGA. All rights reserved. SEGA is registered in the U.S. Patent and Trademark Office. SEGA and SONIC THE HEDGEHOG are either registered trademarks or trademarks of SEGA CORPORATION.

EXPLORE MORE

Mehr entdecken
En savoir plus
Esplora di più
Explora más
Explorar mais
了解更多
Zobacz więcej
Objev vice
Objav viac
Tudj meg többet!
Descoperă mai multe
Разглядайте още
Izpeti vairāk
Uuri lähemalt
Atraskite daugiau



LEGO.com/sonic



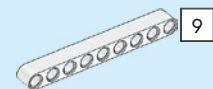

9

2x
6001831



4x
4504369



4x
4547489



2x
6276981



2x
6345327



3x
6051511



3x
362301



1x
302101



1x
306201



3x
6296132



1x
6361170



1x
6089696



1x
6284572



1x
4278271



1x
6507816



1x
6173116



2x
6089698



1x
6053011



1x
407921



2x
6399645



1x
6378120



4x
6360104



2x
4142865



1x
4504379

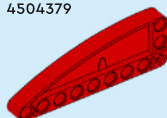

4x
6530412

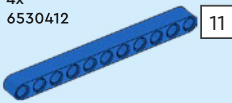

11

2x
6390388



1x
6501150



1x
6452519



1x
6529882



8x
4206482



2x
6299813



1x
6530425



3x
6508325



2x
6168646



2x
6248496



1x
6177083



1x
6321194



17x
6279875



4x
4198367



1x
368026



1x
6156991



2x
306226



1x
302226



1x
6380236



2x
6313116



1x
6469787



1x
6133852



2x
6182261



1x
6021999



1x
6073040



1x
6314353



1x
6443215



4x
6236454



2x
6514189



1x
6247795



3x
6245306



1x
6507917



1x
6514014

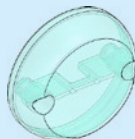

2x
6507988



2x
6166857



1x
6214811



1x
4631385



2x
6236571



1x
6214812



3x
6371437



1x
6116613



2x
6043656



1x
4654580



3x
6043639



2x
4211525



3x
6248890



3x
4211399



2x
6225246



1x
4540203



4x
6332045



2x
6039482



1x
6309059



2x
6039479



4x
4210848



4x
6199549



1x
6359227



1x
6439040



4x
6015356



1x
6083620

4



 [LEGO.com/service](https://www.LEGO.com/service)

YOU COULD
WIN

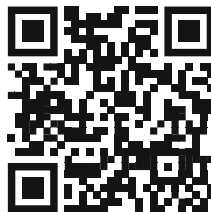

Scan this QR code or go to
LEGO.COM/PRODUCTFEEDBACK and give
us your short feedback about this LEGO® set
for a chance to win a cool LEGO prize.

Terms and Conditions apply*



EN: YOU COULD WIN. Terms and Conditions apply* **DE: Du könntest GEWINNEN.** Es gelten die Teilnahmebedingungen* **FR: Tu pourrais GAGNER.** Des conditions s'appliquent* **IT: Potresti VINCERE tu.** Termini e condizioni sono applicabili* **ES: Puedes GANAR.** Aplican términos y condiciones* **PT: Poderá GANHAR.** Aplicam-se termos e condições* **ZH: 轻松获奖. 条款和条件适用*** **PL: Szansa na WYGRANĄ.** Obowiązują warunki korzystania* **CS: Máte šanci VYHRÁT.** Platí všeobecné smluvní podmínky* **SK: Máte šancu VYHRAŤ.** Platia všeobecné zmluvné podmienky* **HU: TE IS NYERHETSZ.** Felhasználási feltételek érvényesek* **RO: Ai putea CÂȘTIGA.** Se aplică termenii și condiții* **BG: Можете да СПЕЧЕЛИТЕ.** Има определени правила и условия* **LV: Tu vari LAIMĒT.** Ir spēkā noteikumi un nosacījumi.* **ET: Sul on võimalus VÕITA.** Kehtivad tingimused* **LT: Jūs galite LAIMĖTI.** Taikomos sąlygos*

*[LEGO.com/productfeedback-terms](https://www.lego.com/productfeedback-terms)

LEGO and the LEGO logo are trademarks of the LEGO Group. ©2025 The LEGO Group.

©SEGA. All rights reserved. SEGA is registered in the U.S. Patent and Trademark Office.

SEGA and SONIC THE HEDGEHOG are either registered trademarks or trademarks of SEGA CORPORATION.

6555866