

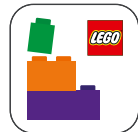

10342



Booklet available in English  
Heft in deutscher Sprache erhältlich  
Livret disponible en français  
Libretto disponibile in italiano  
Folleto disponible en español  
如需中文版手册



LEGO® Builder

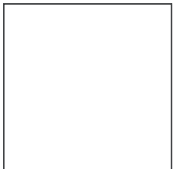



LEGO.com/sustainable-packaging



FR  
**DONNEZ**  
OU  
**RECYCLEZ**



ASSOCIATION

OU



MAGASIN

OU



DÉCHÈTERIE

Adresses sur [quefairedemesdechets.fr](http://quefairedemesdechets.fr)



# BUiLDER



Apple and the Apple logo are trademarks of Apple Inc., registered in the U.S. and other countries and regions. App Store is a service mark of Apple Inc. Google Play and the Google Play logo are trademarks of Google LLC. Tencent and the Tencent logo are trademarks of Tencent Inc.

Q [LEGO.com/devicecheck](https://LEGO.com/devicecheck)



Q LEGO® Builder



**EN** Build It Your Way | **DE** Bau, wie du willst | **FR** Construisez à votre façon | **IT** Costruiscilo come vuoi tu | **ES** Constrúyelo a tu manera  
| **PT** Constrói à Tua Maneira | **ZH** 自由拼搭 | **PL** Zbuduj po swojemu | **CS** Postavte to po svém | **SK** Postavte to po svojom | **HU** Építs kedved szerint!  
| **RO** Construięște așa cum dorești | **BG** Постройте го по своя начин | **LV** Būvē tieši tā, kā vēlies | **ET** Ehita enda moodi | **LT** Sukonstruokite savaip

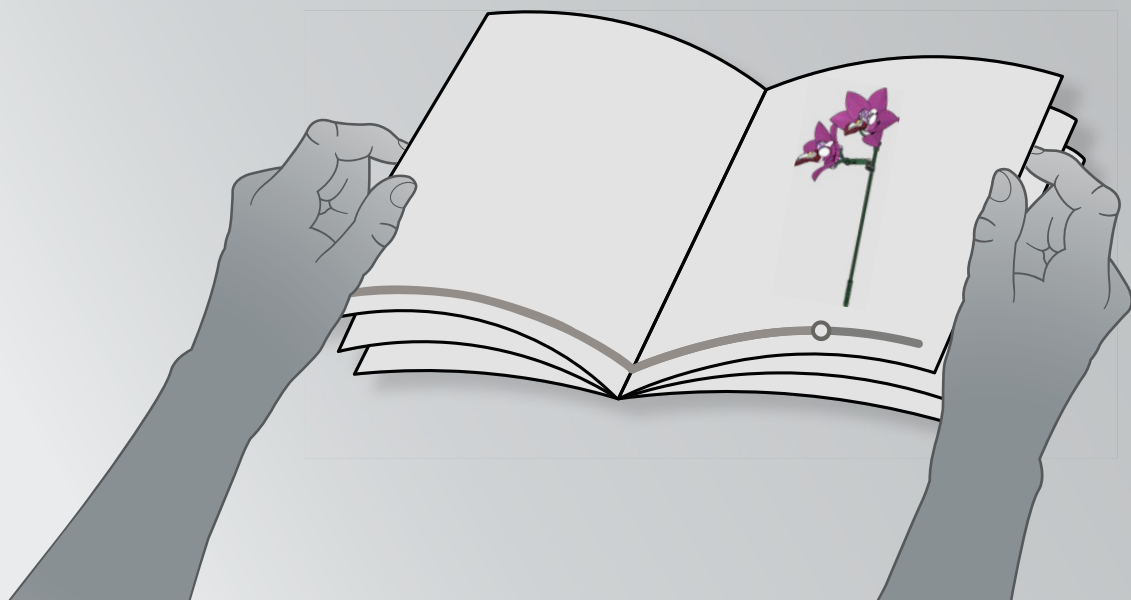
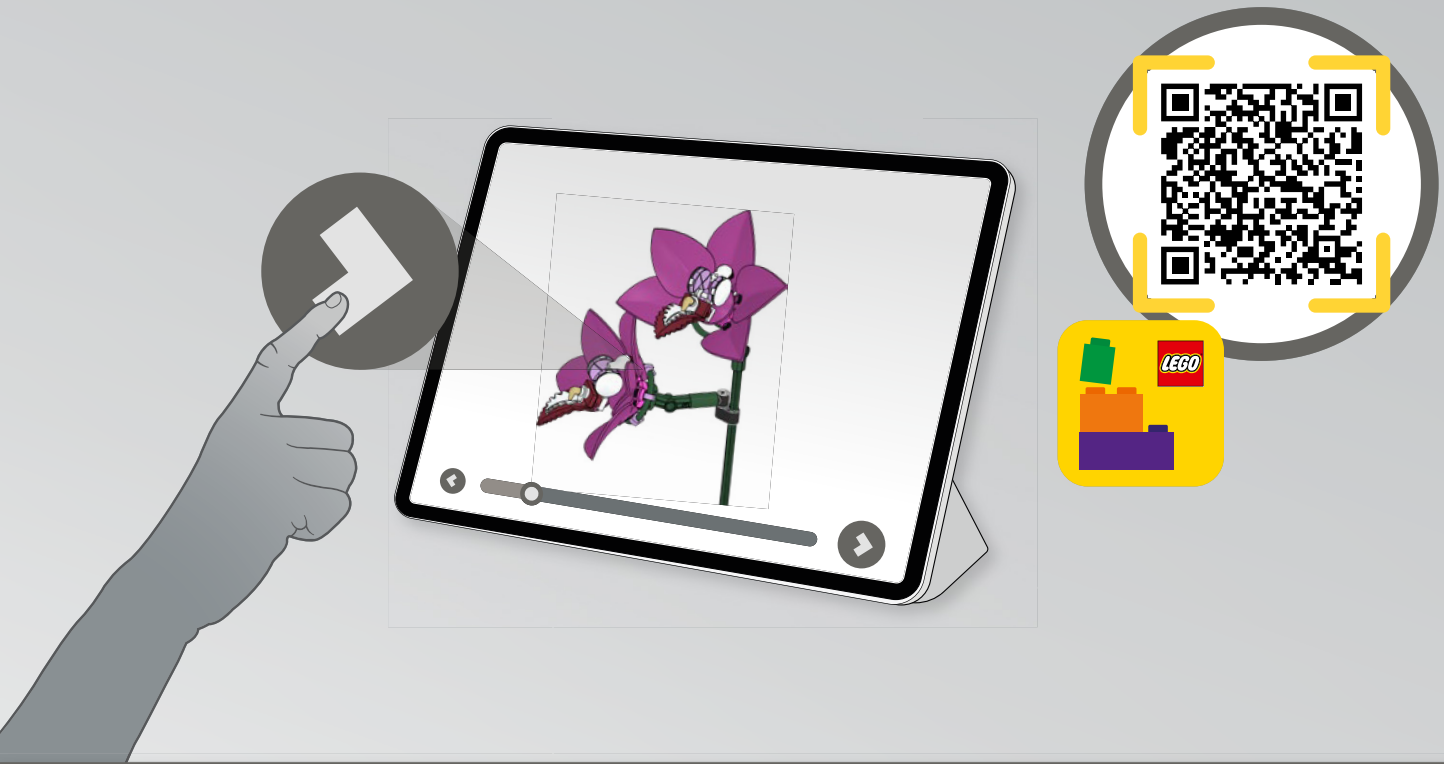

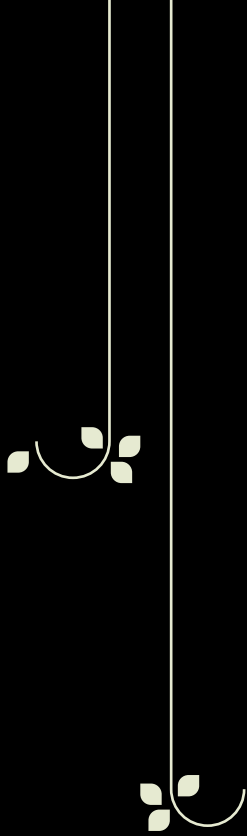

## Elegant by nature

When we design a LEGO® floral arrangement, nature offers us a cornucopia of colours, plant species and scents for inspiration. Styling pastel and vibrantly coloured blossoms with elegant evergreens, we experimented with new techniques (and creative uses of LEGO elements) to bring this lavish bouquet to life. Every detail is meticulously recreated as an authentic and artistic tribute to nature's own diverse treasures.

*The LEGO® Botanicals Design Team*

From rebellious weed to beloved bouquet flower, this beauty thrives in Europe and North America and is wildly popular with bees and butterflies.



*(Centaurea cyanus)*  
CORNFLOWER



*(Eucalyptus pulverulenta)*

## EUCALYPTUS 'BABY BLUE'

Also known as Australian silver-leaved mountain gum, this member of the eucalyptus species often complements flowers in bouquets around the world.

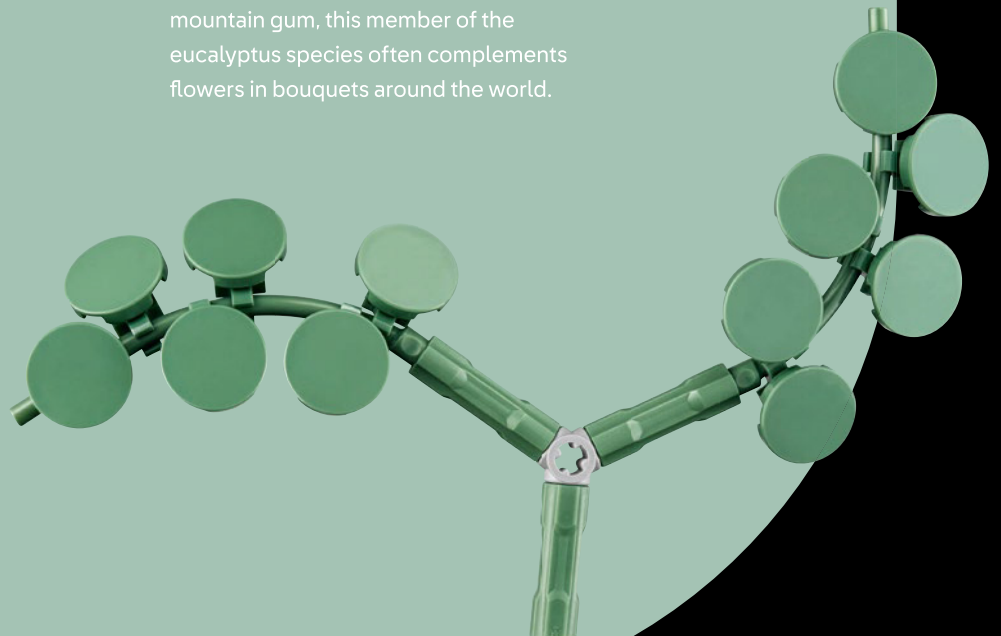

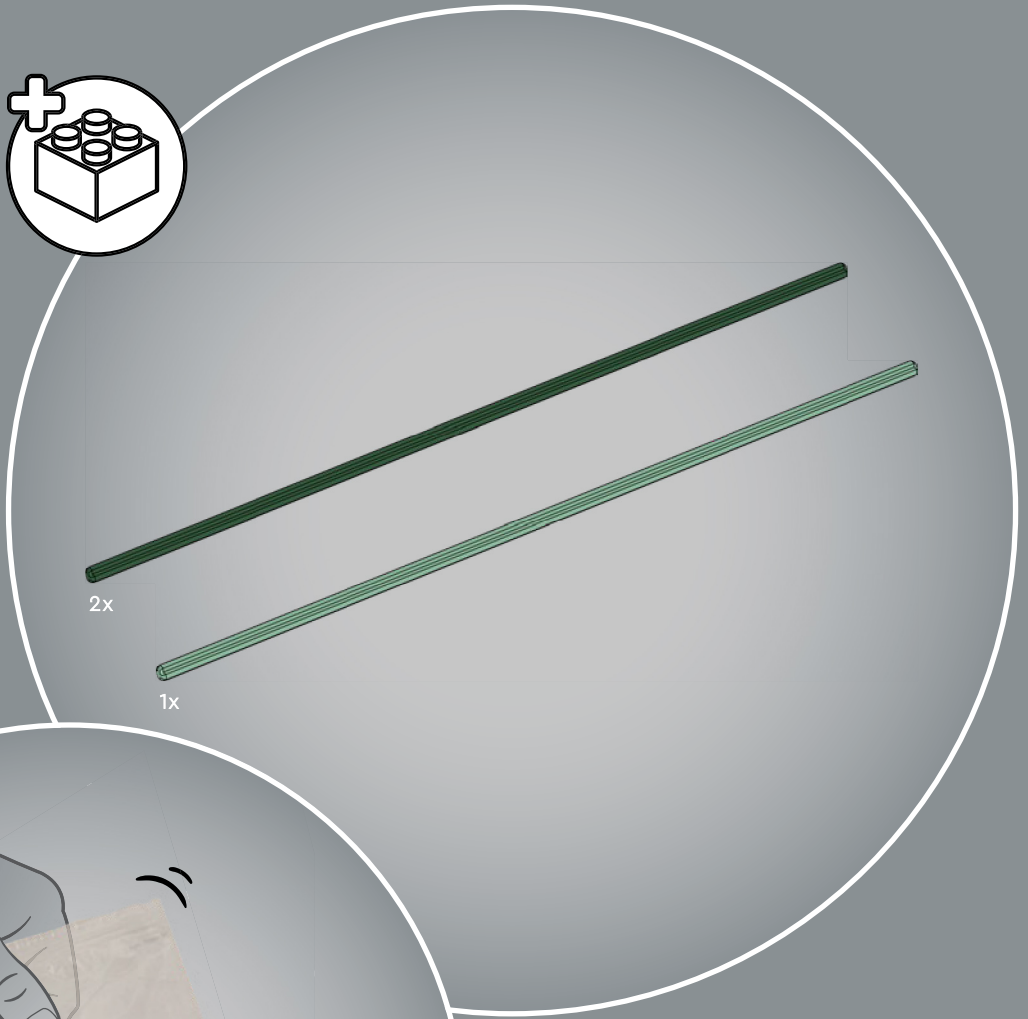
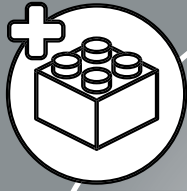





1

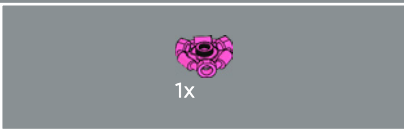
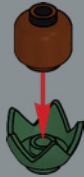

2



3

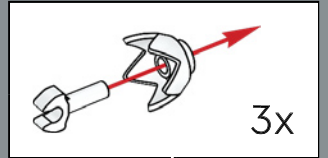

4

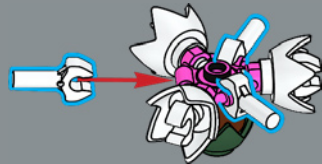

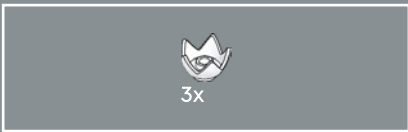

5

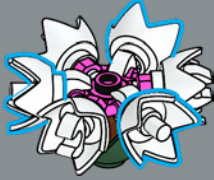

These little LEGO® bricks used for the cornflower petals are actually minifigure crowns.



6

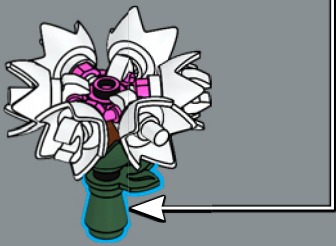
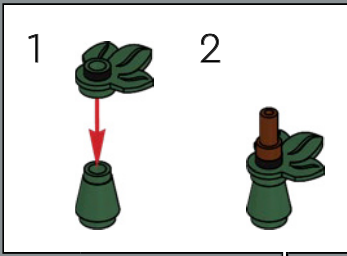

7

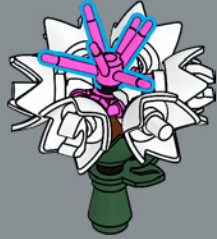

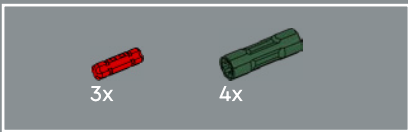

8

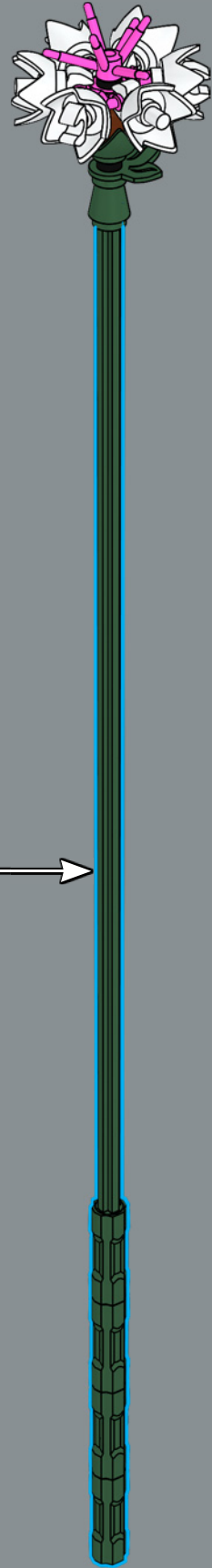
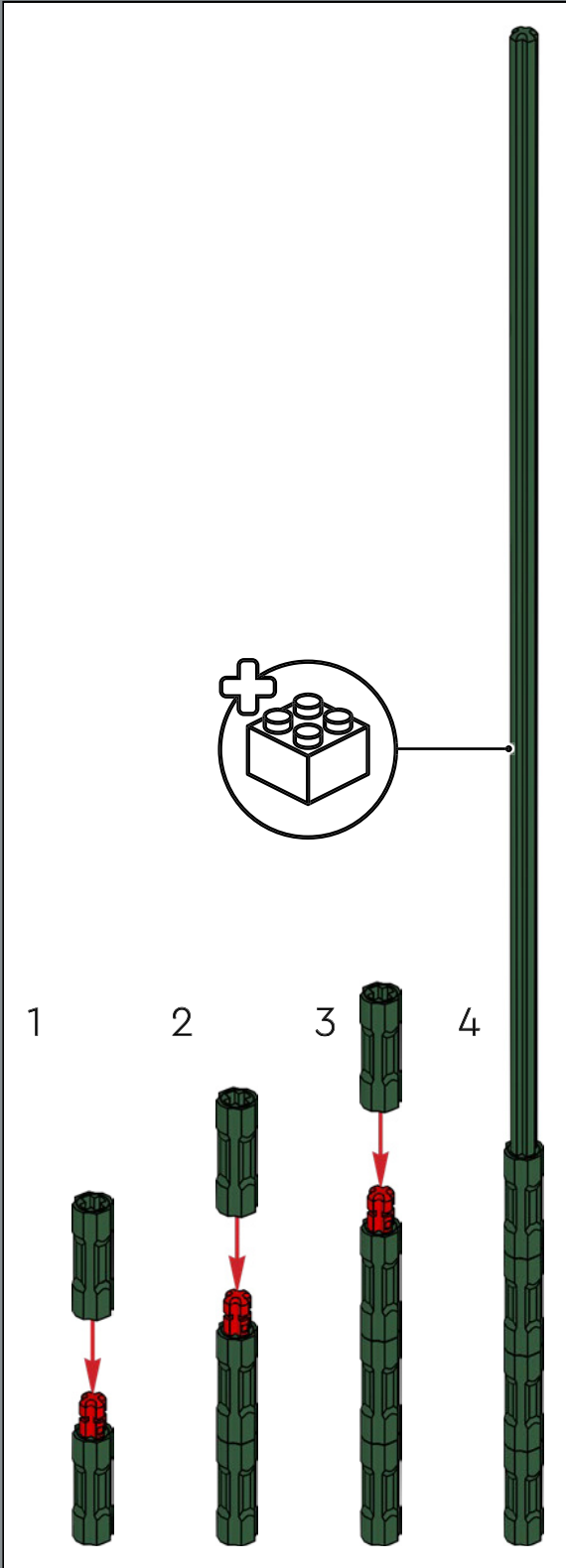

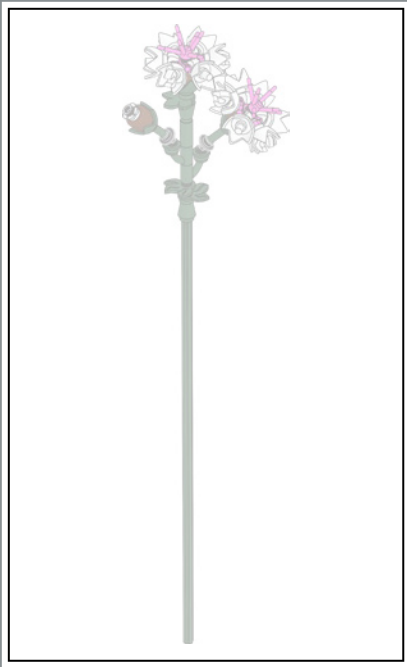

1

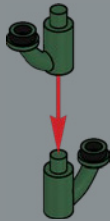

2

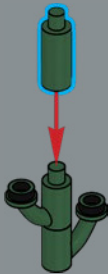

3

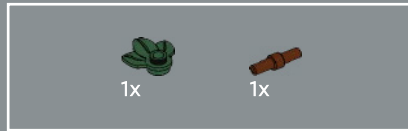
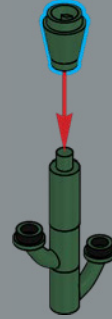

4

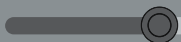



5



6

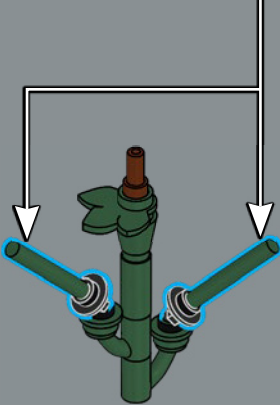
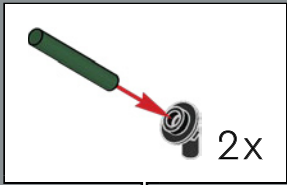

7

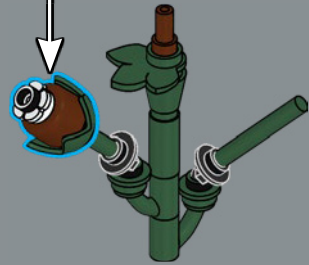
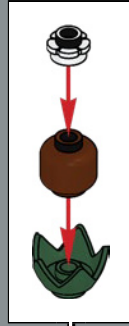



8

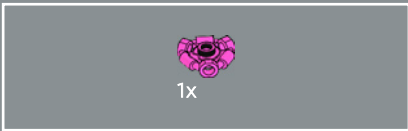
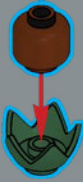

9



10

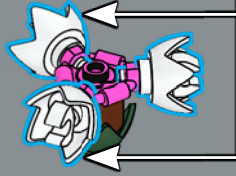
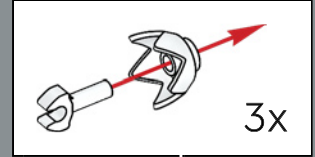

11

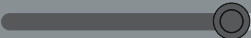
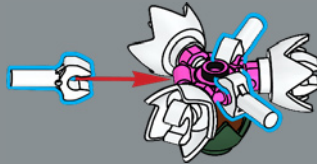

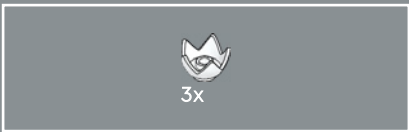

12

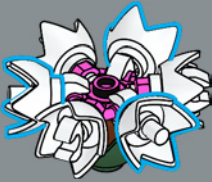

13



2x

14

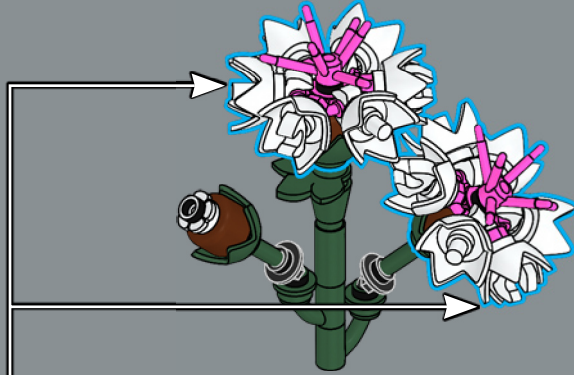

15

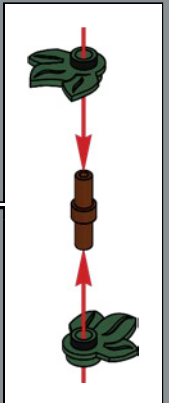
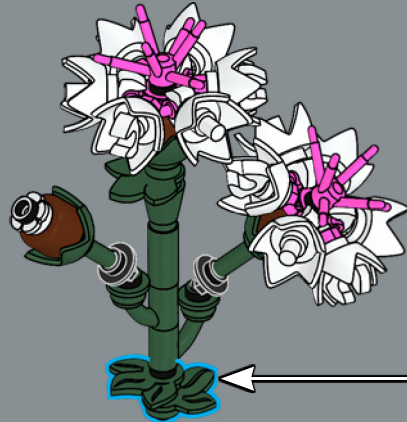

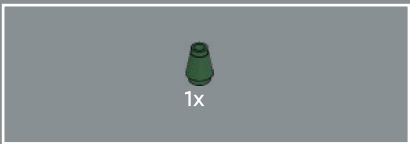

16

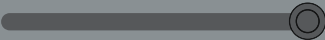
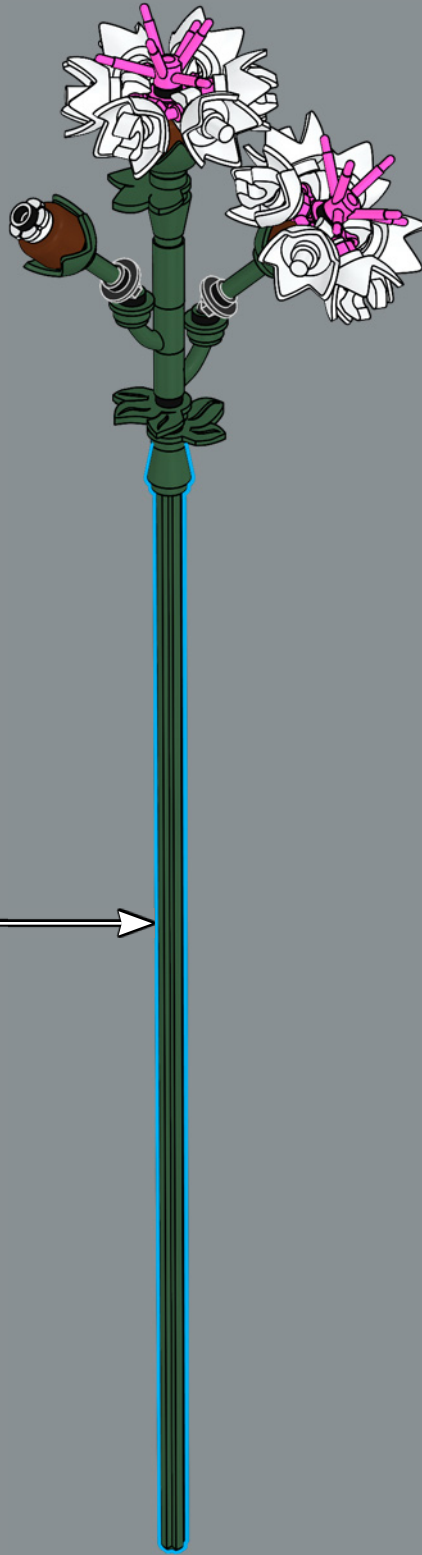
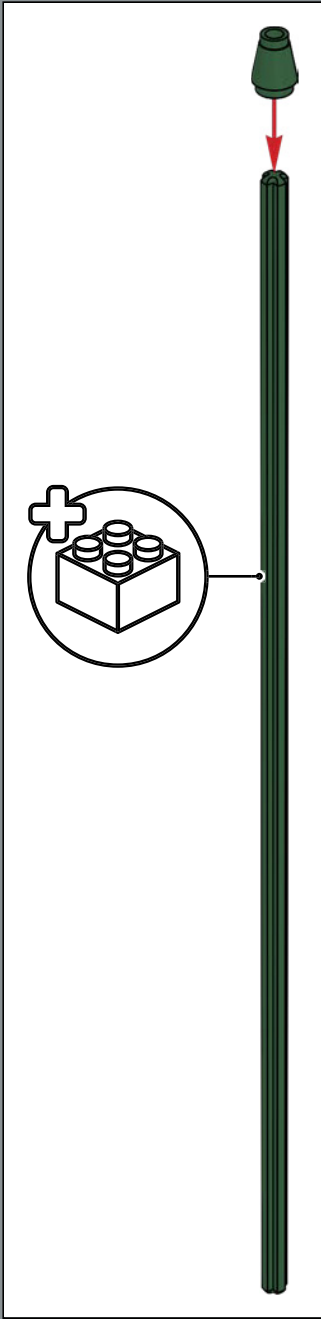



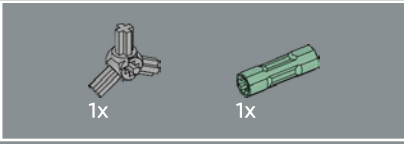

1

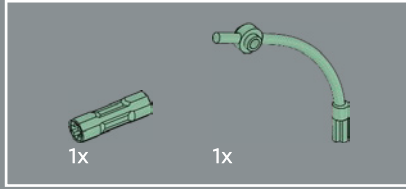
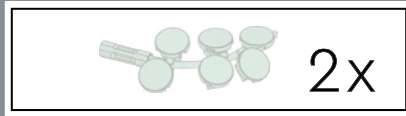
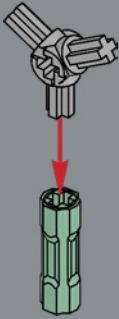

2

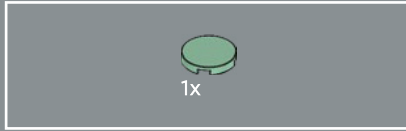
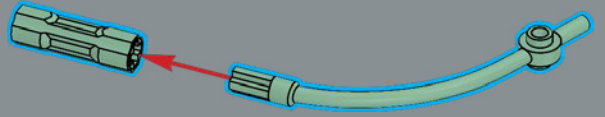

3

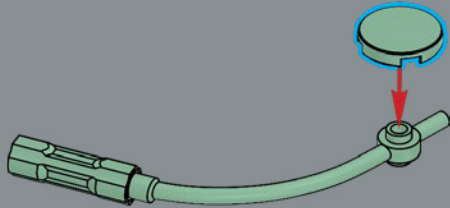



4

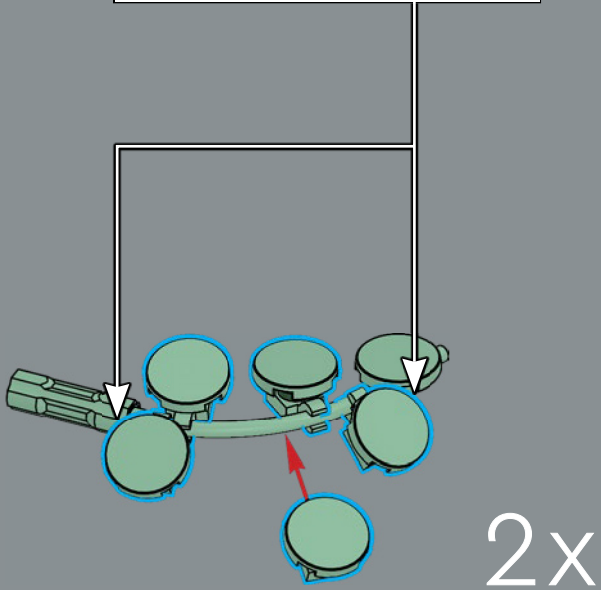
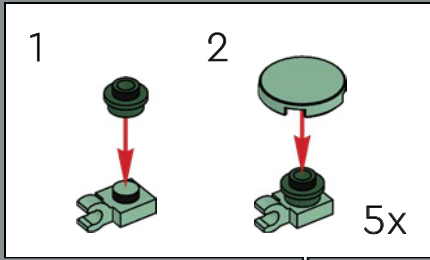

5

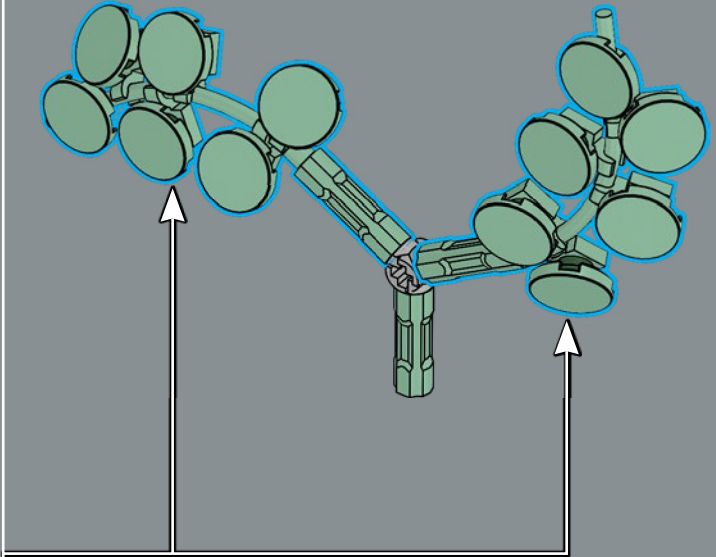



6

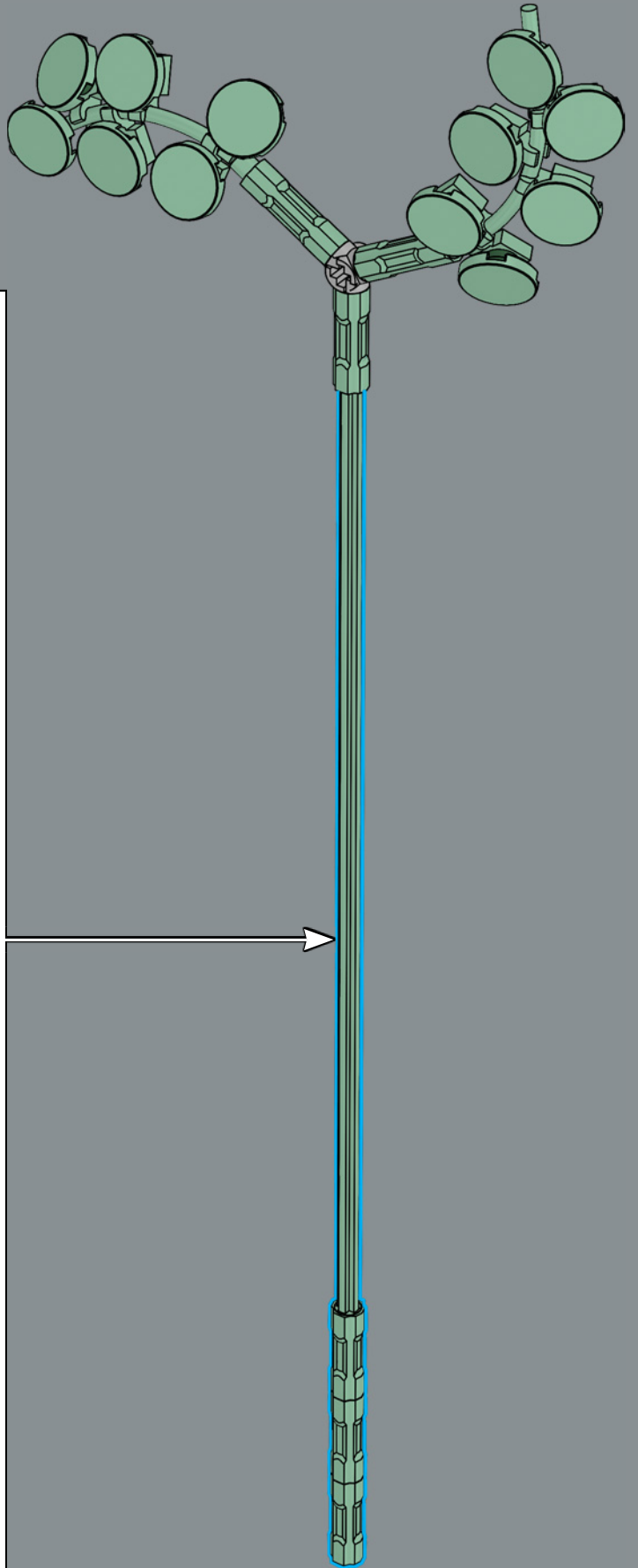
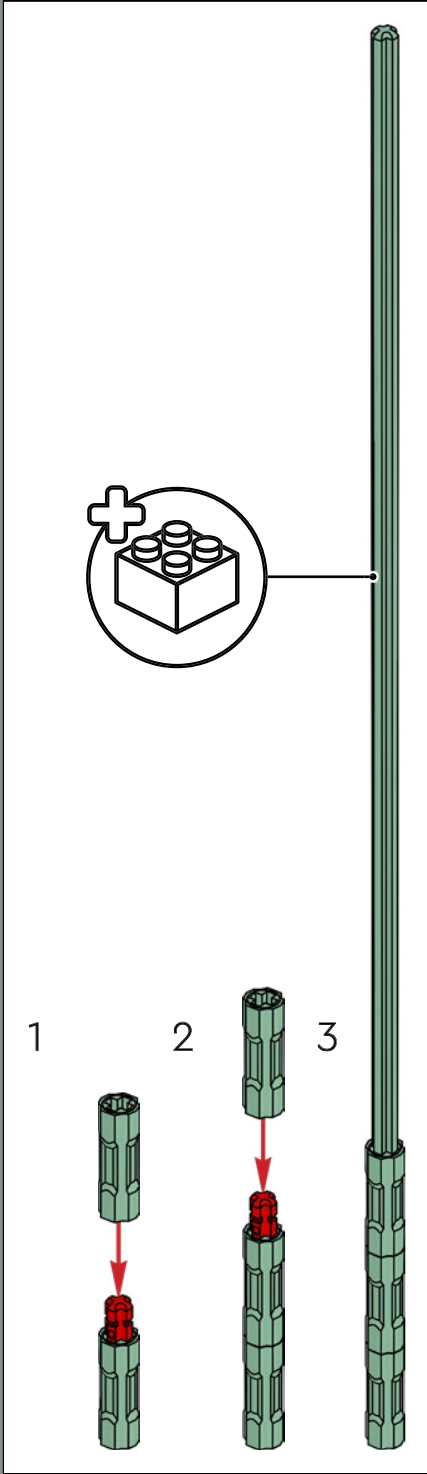



*(Sambucus nigra)*

## ELDER

Deciduous elder shrub species vary globally but most produce delicate white flowers and dark purple berries. Both are popular flavours in food and drinks.

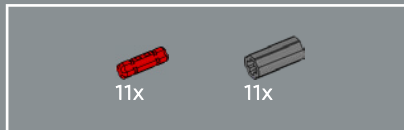

1

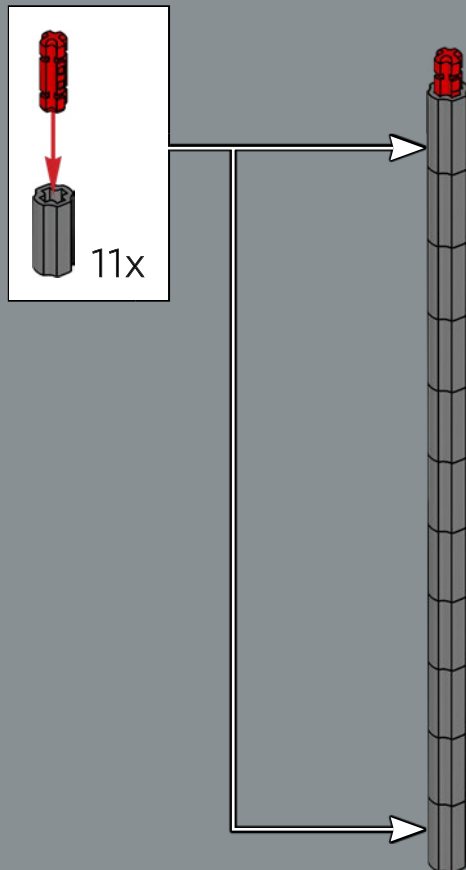

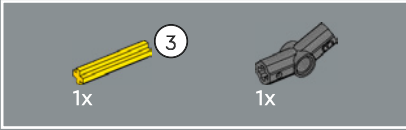
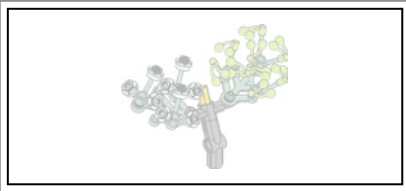

2

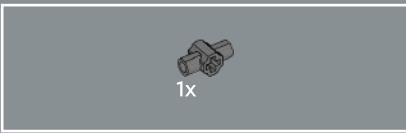
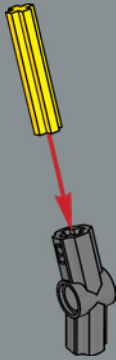

3

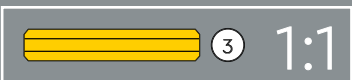
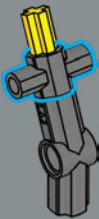

4

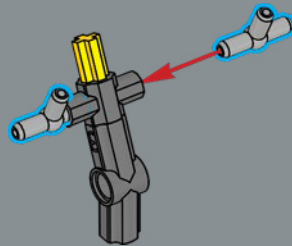

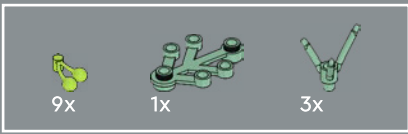

5

1



2

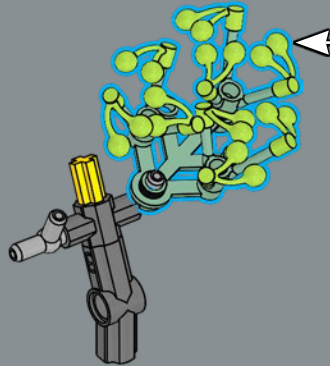
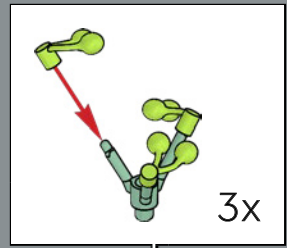
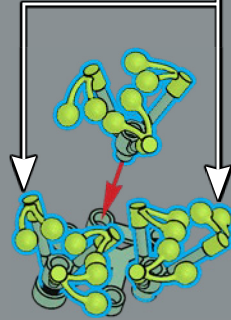

The unopened elder buds here are built using classic LEGO® minifigure cherries.

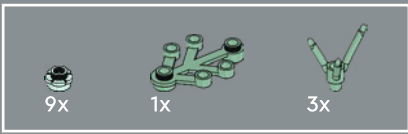

6

1



2

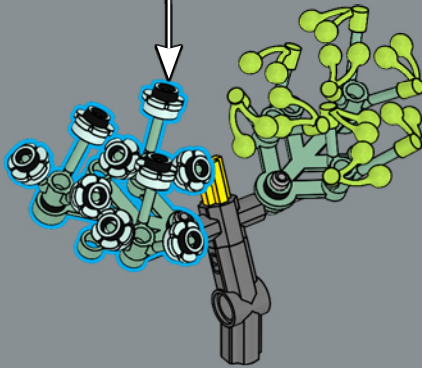
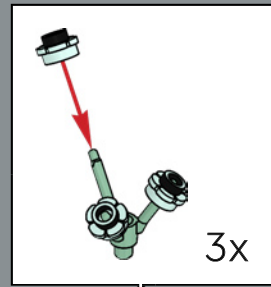
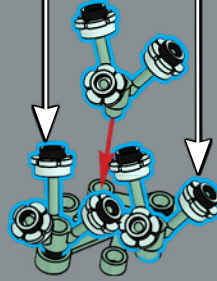



7

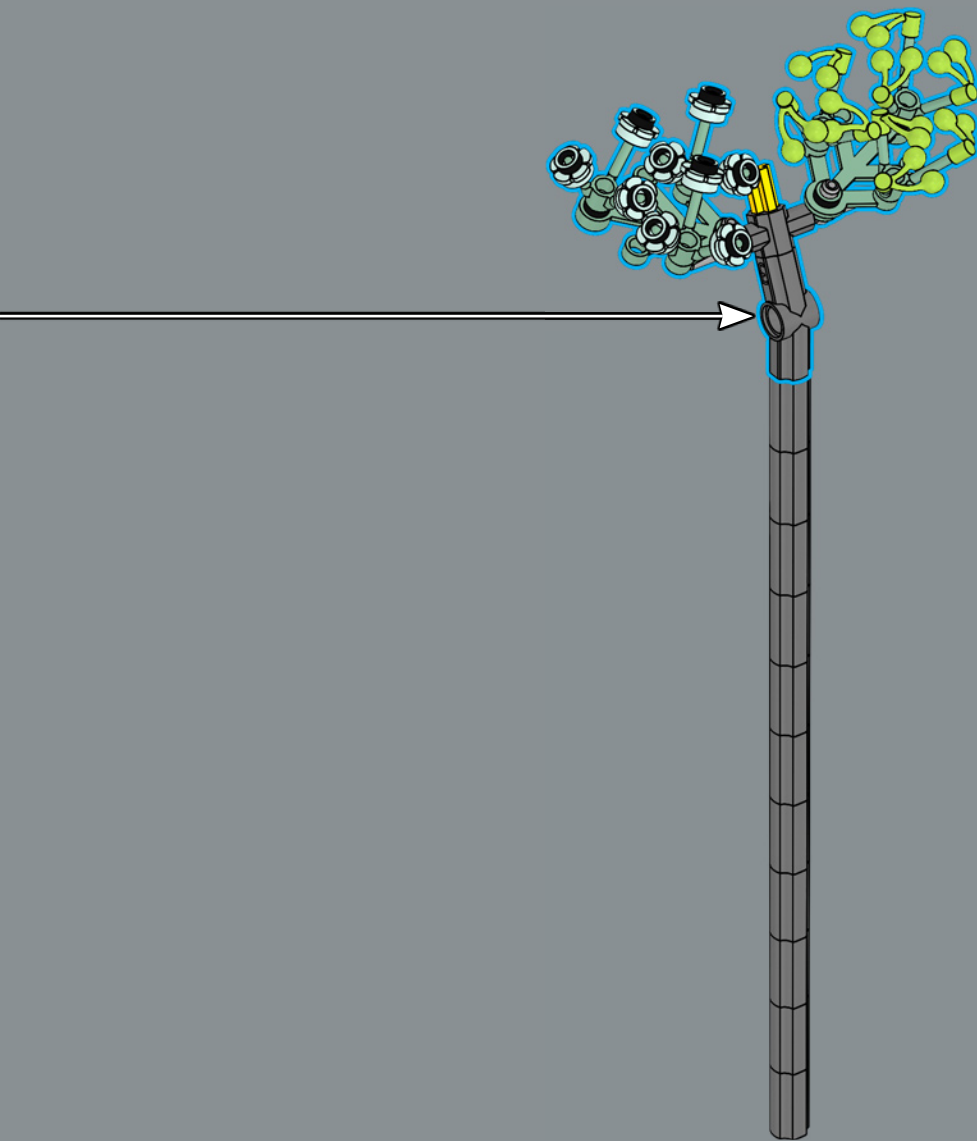

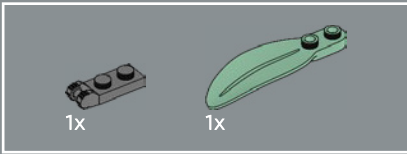
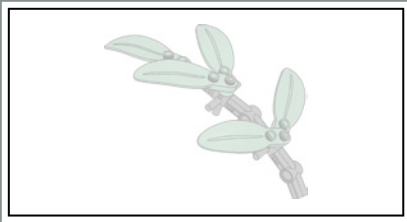

8

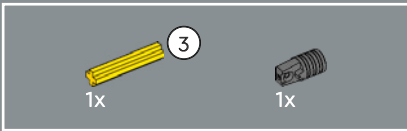
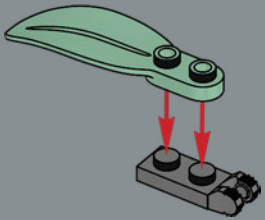

9

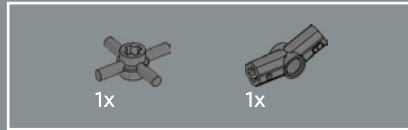
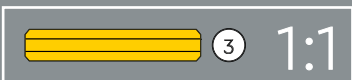
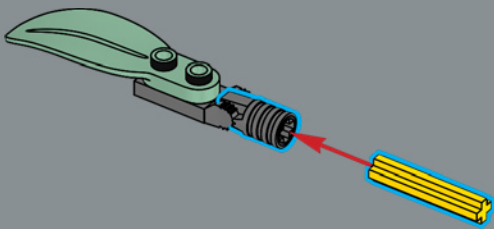

10

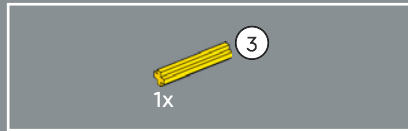
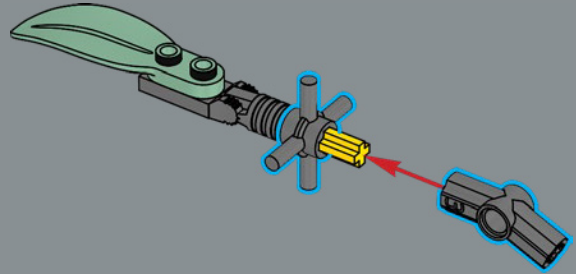

11

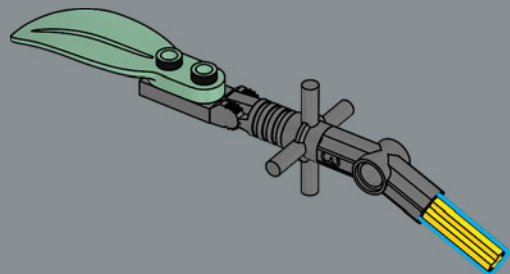

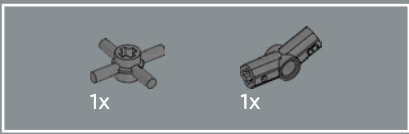

12

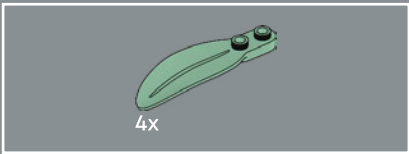
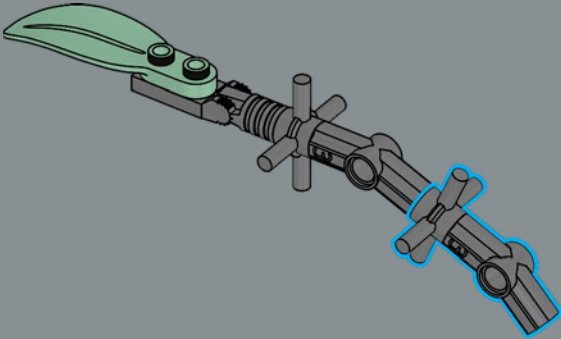

13

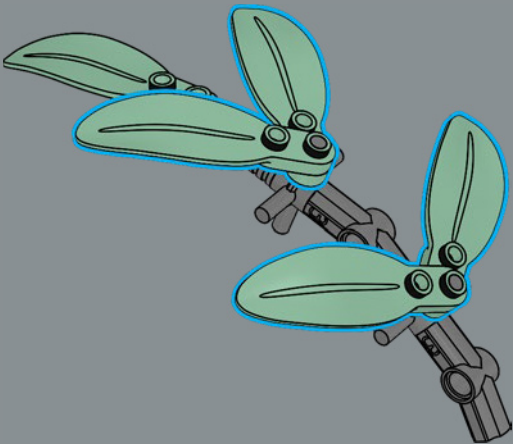

14

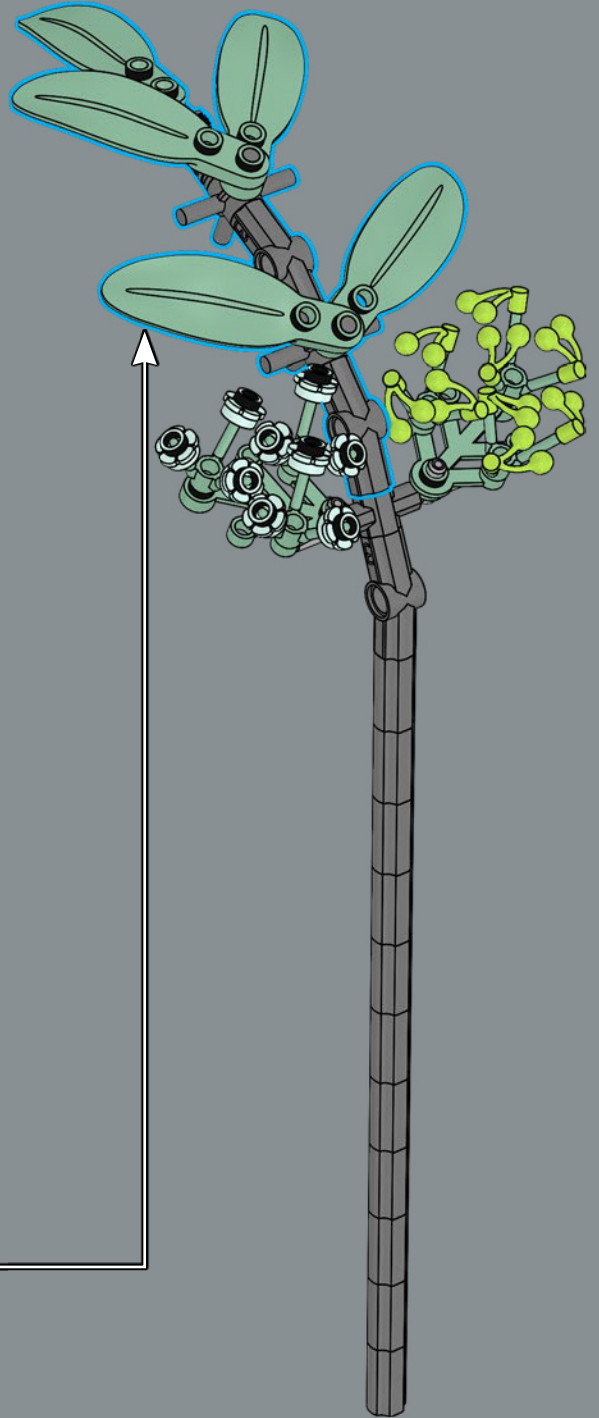

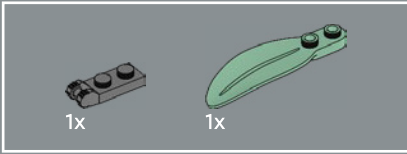
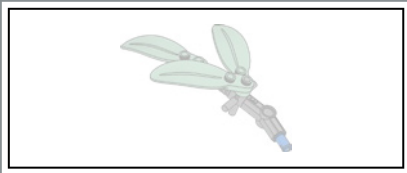

15

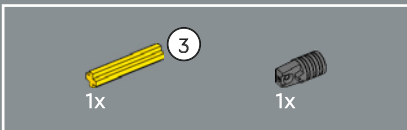
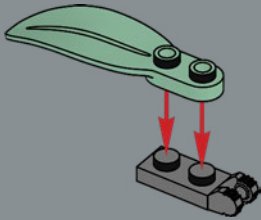

16

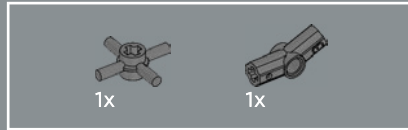
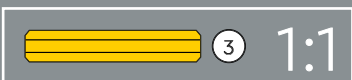
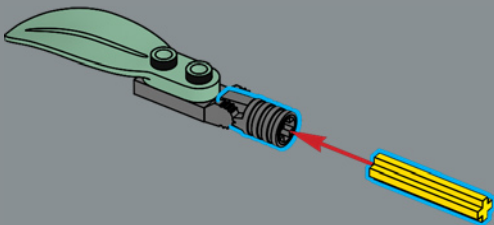

17

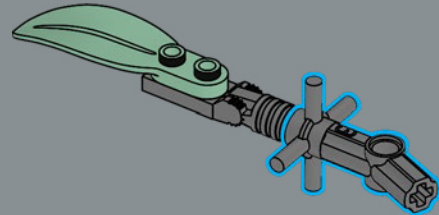

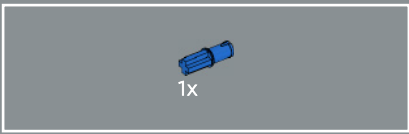

18

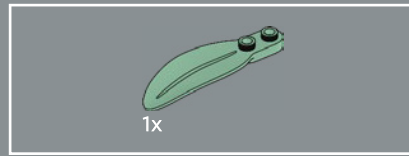
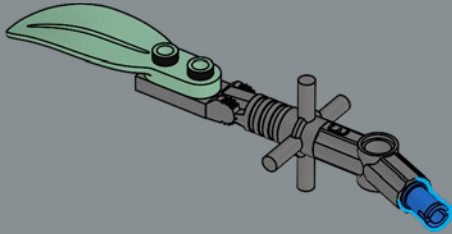

19

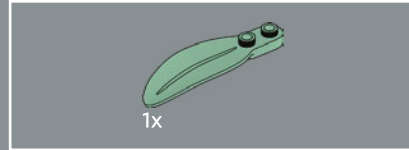
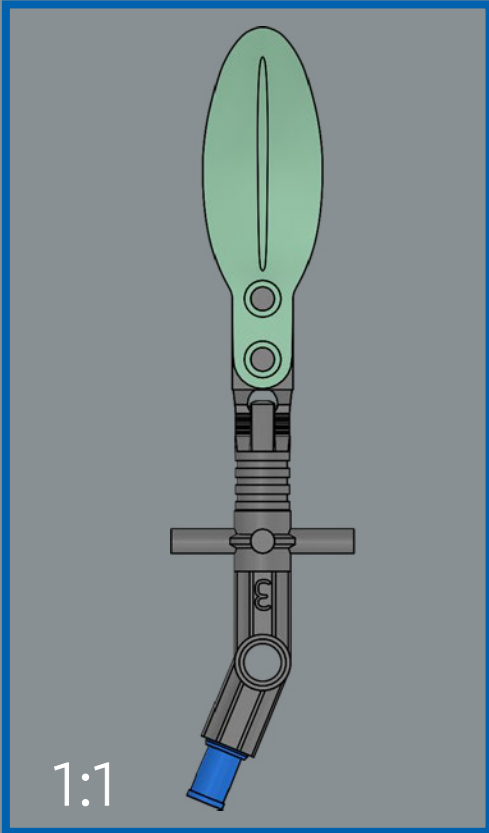
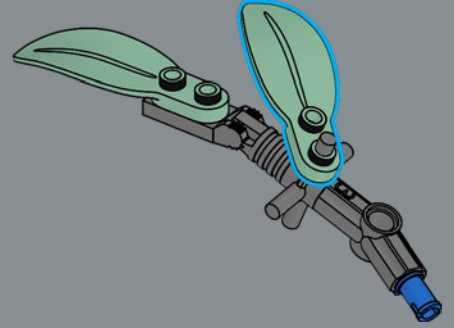

20

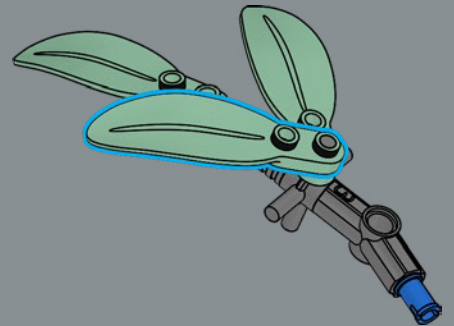

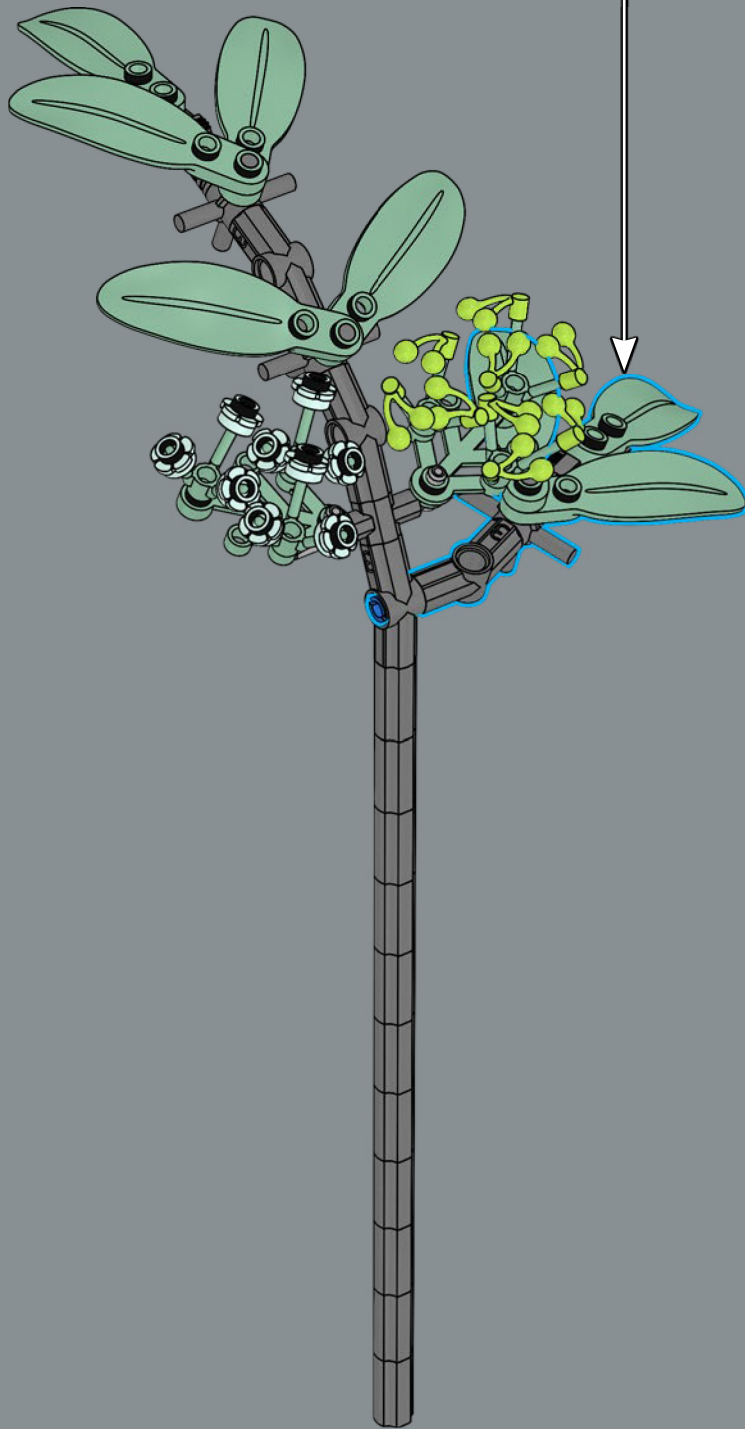

2x





*(Rosa)*

## ROSE

Gifted as symbols of love and tokens of beauty for centuries, roses in every colour add grace to any bouquet – in real life, and in LEGO® form.



*(Felicia amelloides)*

## BLUE DAISY

Commonly found in Europe and North America, blue daisies symbolise commitment and trust, making them a perfect gift for a loved one.

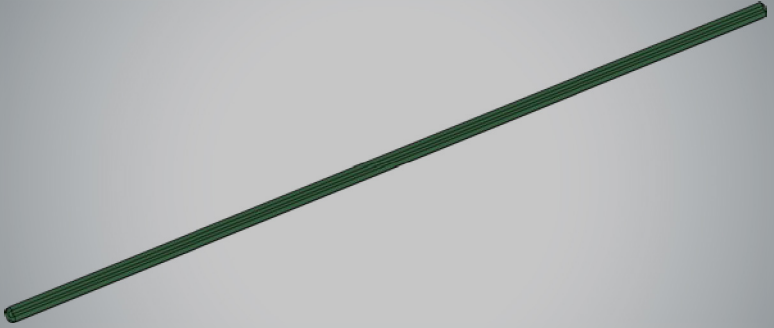
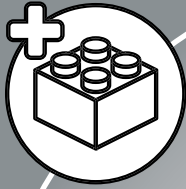

2x





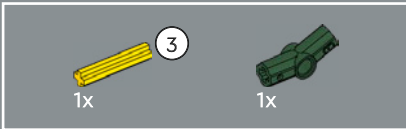
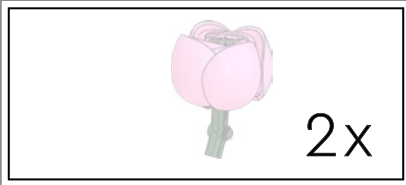
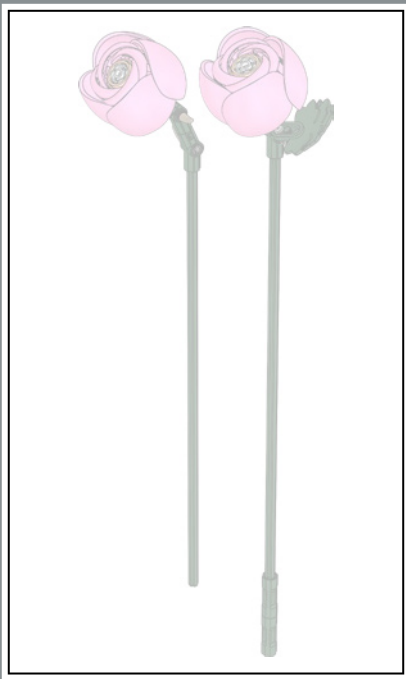

1

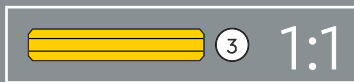
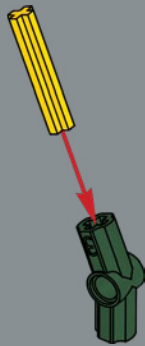

2

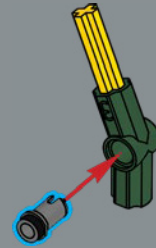

3



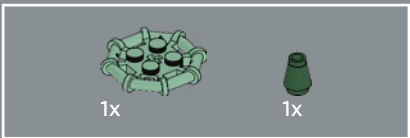

4



5



6

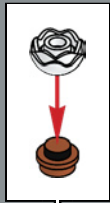

Our LEGO® minifigures like flowers too. This little flower, originally designed as a small peony, now forms the center of a rose.

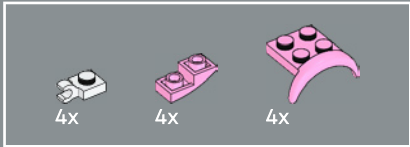

7

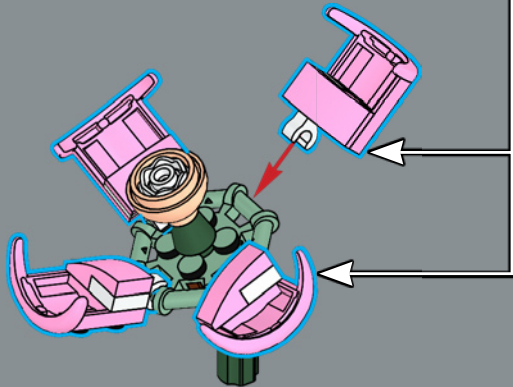
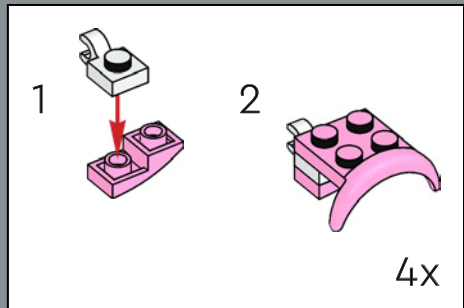

8

The central spiral of petals in this rose is built from LEGO® car wheel arches.

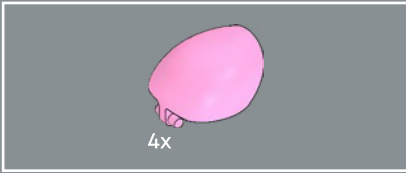
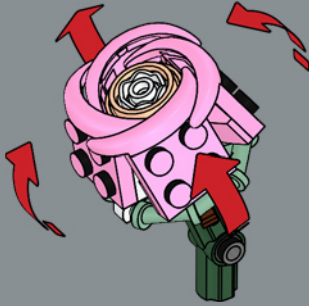

9

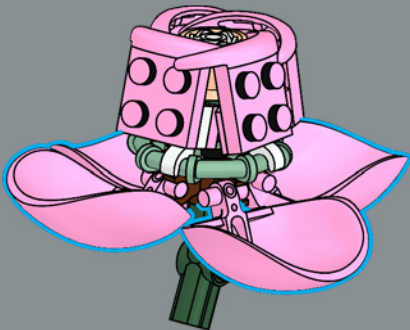

10

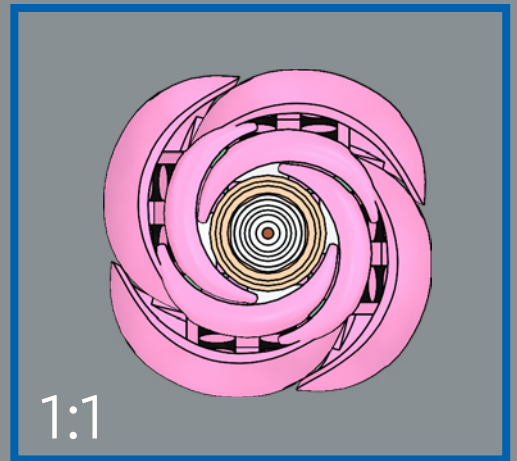
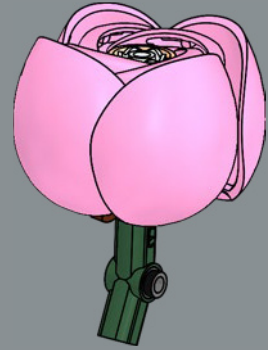

2x

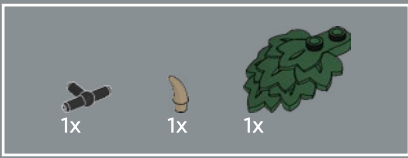

11

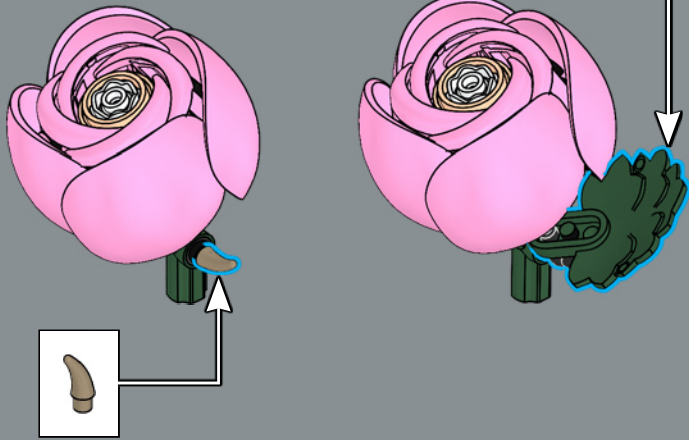
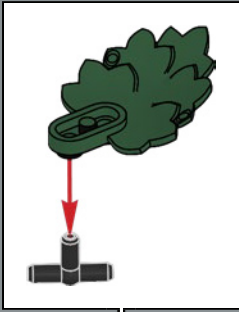

12

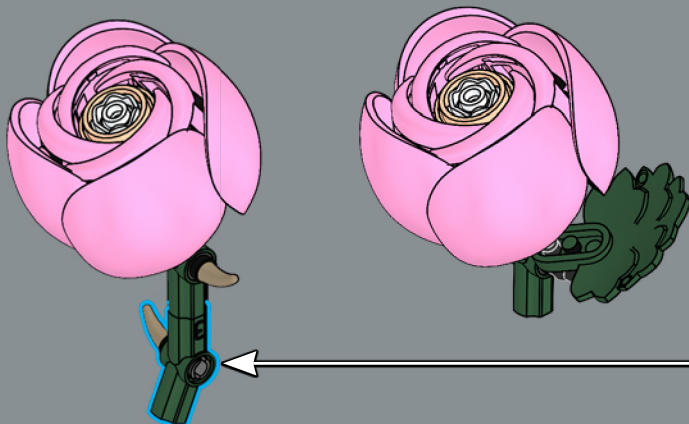
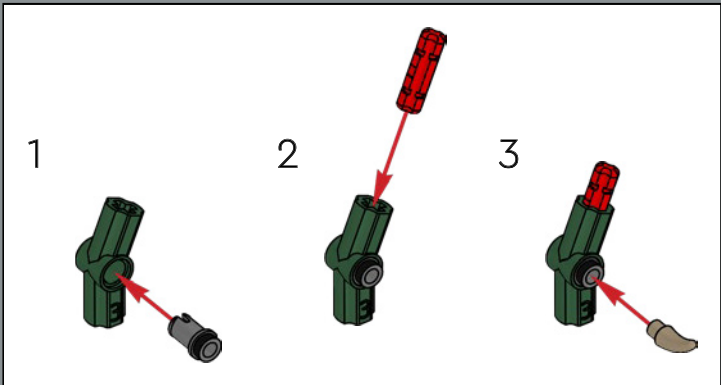

13

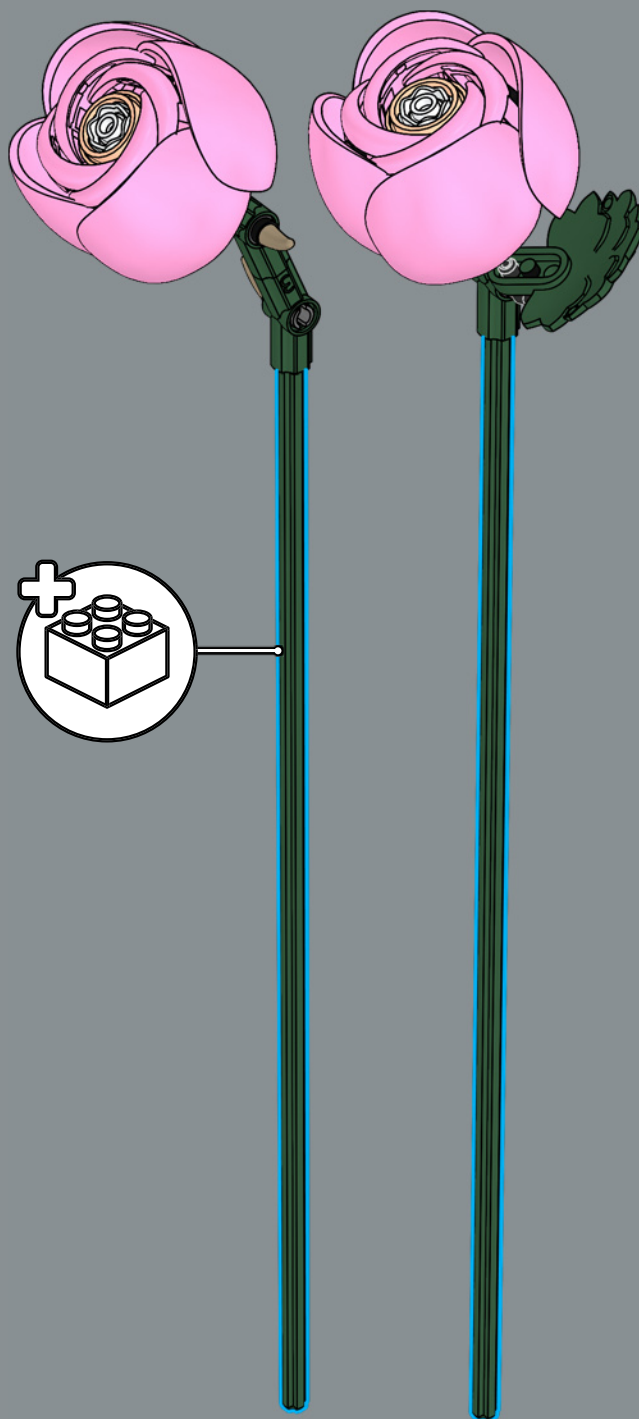

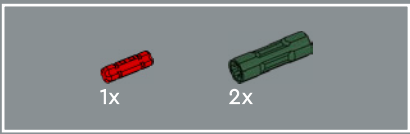

14

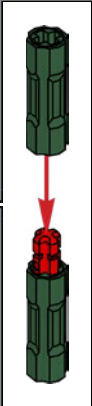
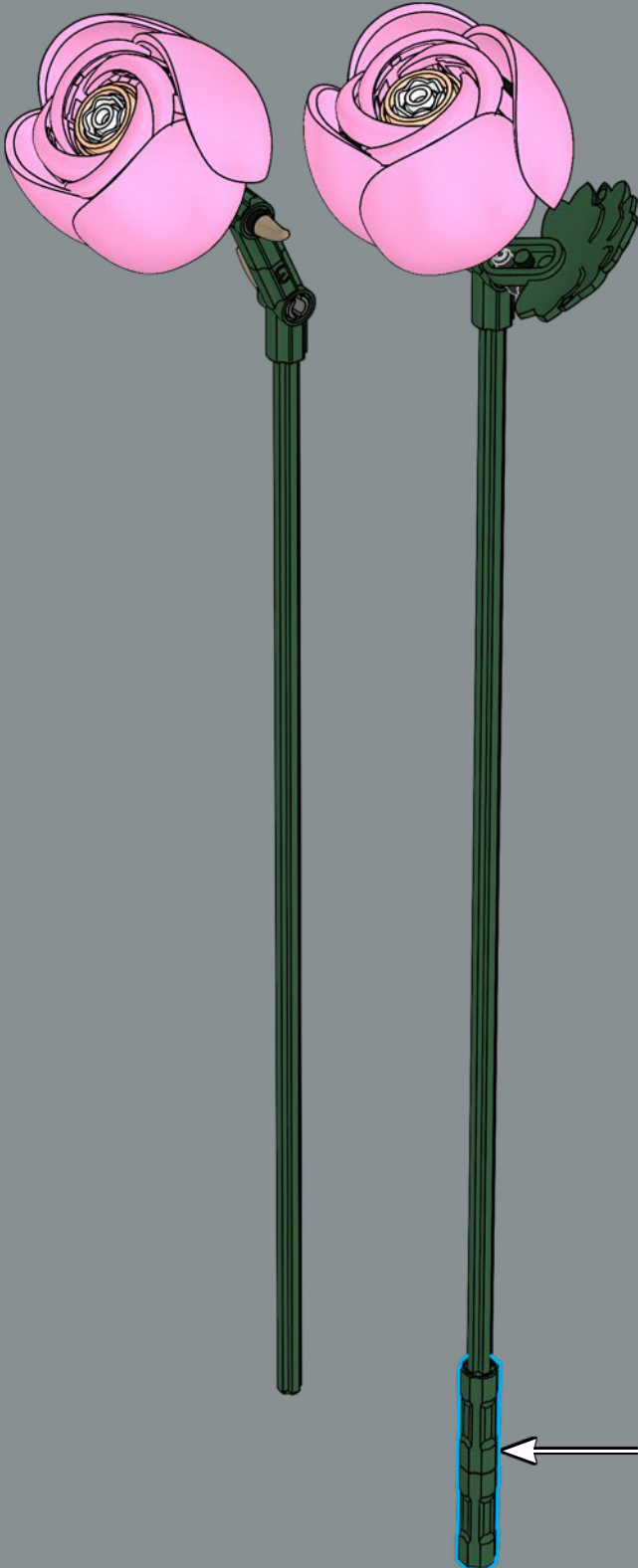

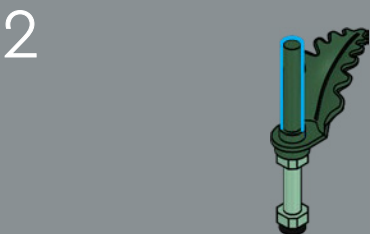
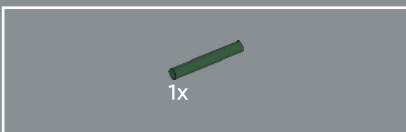
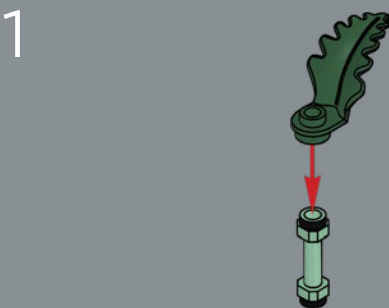
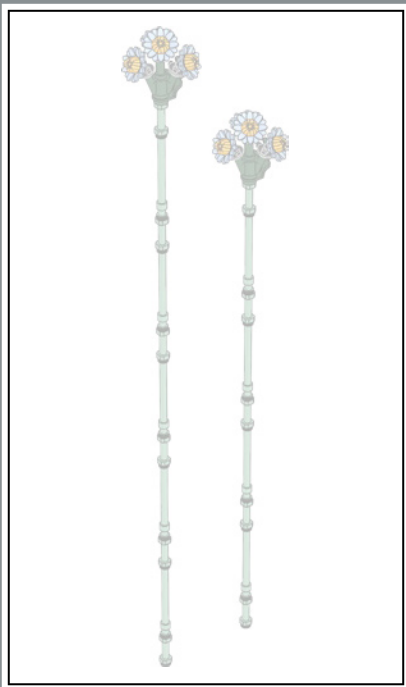

3

This little tripod element was meant to help LEGO® minifigures steady their cameras. Now it holds a little bunch of daisies.

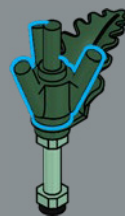

4

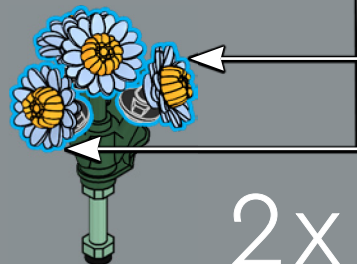
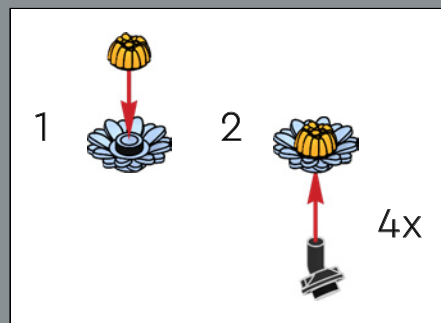

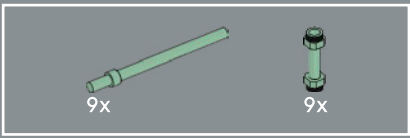

5

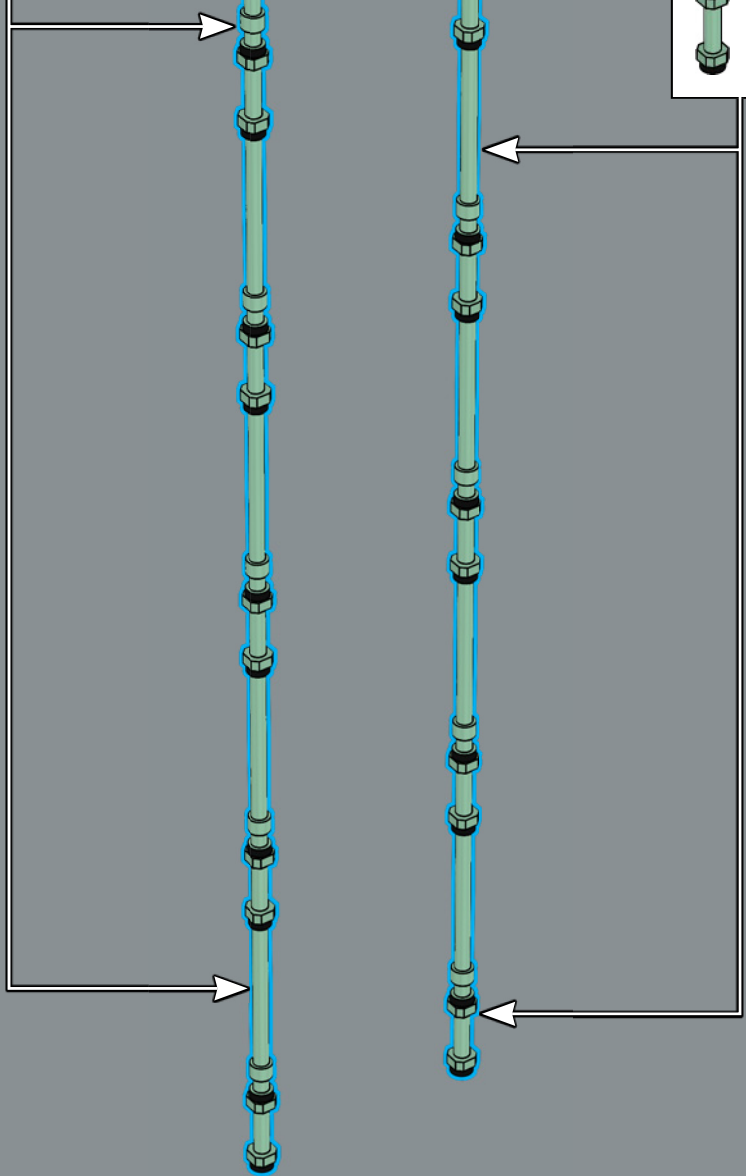
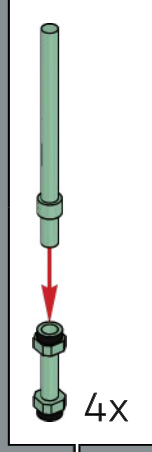
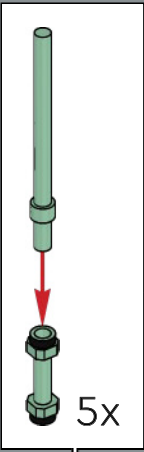





(*Campanula medium*)

## CANTERBURY BELLS

A Southern European biennial, the *Campanula's* cup- or bell-shaped blossoms can usually be seen in blue, white or pink hues all through the summer.



(*Ranunculus*)

## PERSIAN BUTTERCUP

Native to Europe, North America and Asia, the Persian buttercup, with its intricate layers of pastel-coloured petals, is always popular bouquet material.

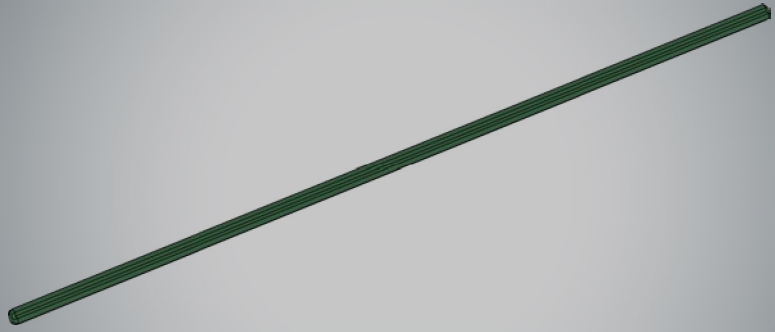
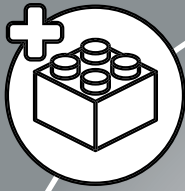

1x



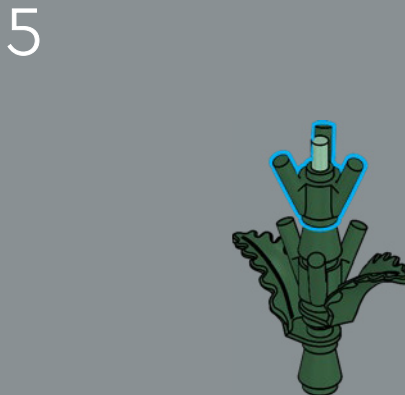
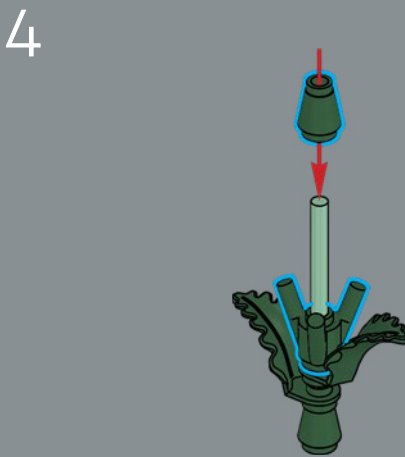
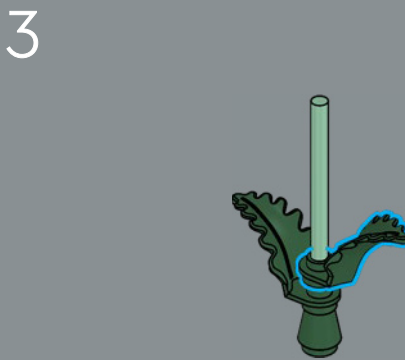
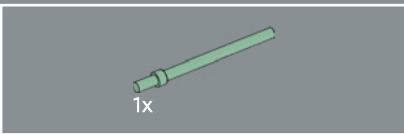
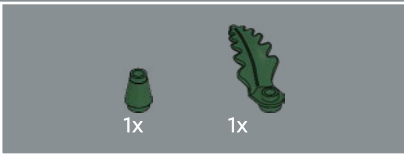
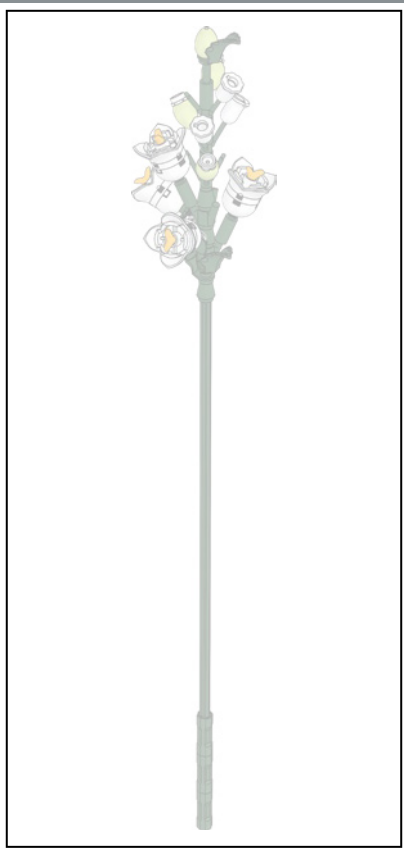

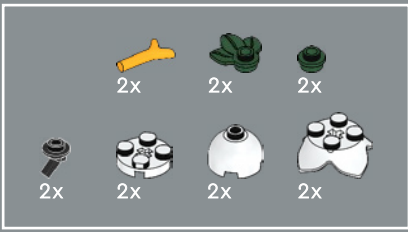

6

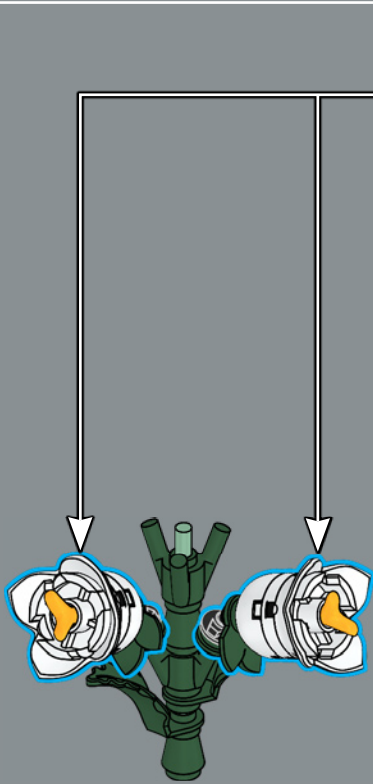
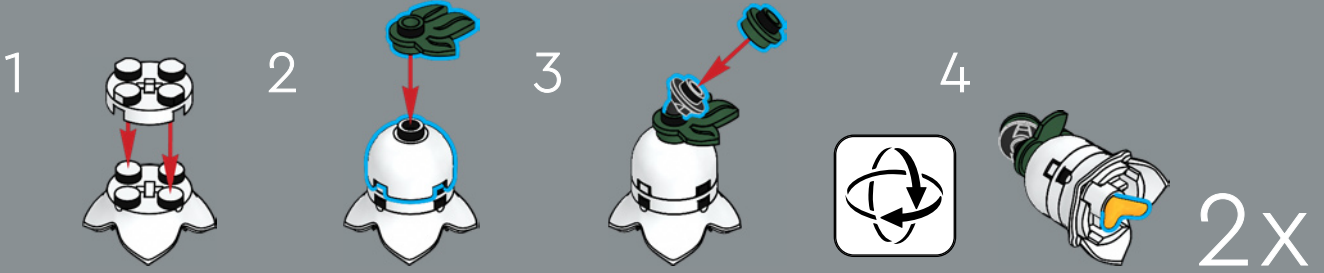



7

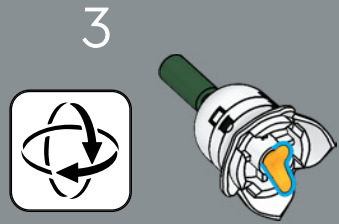
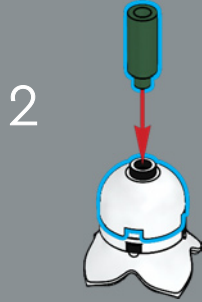
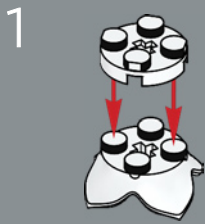

2x

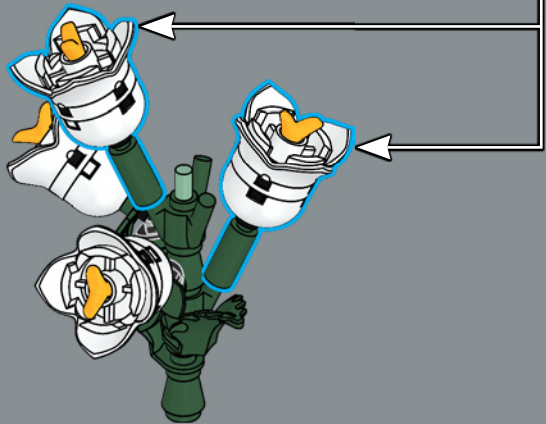

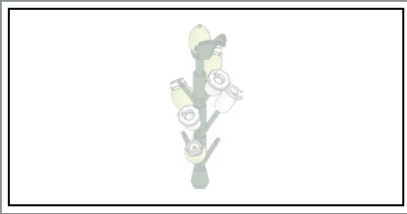

8

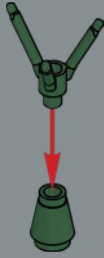

9

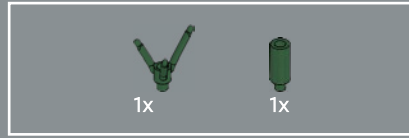
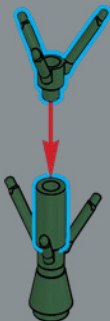

10

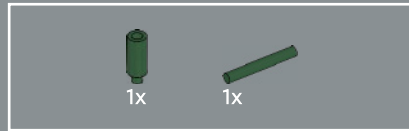
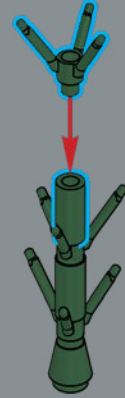

11

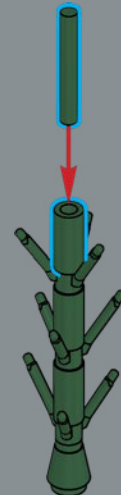



12

One of our characters from the LEGO® DREAMzz™ line is used here to represent a small *Campanula* blossom.

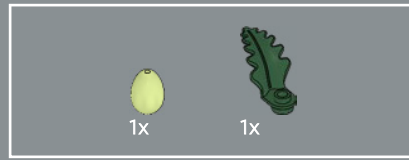
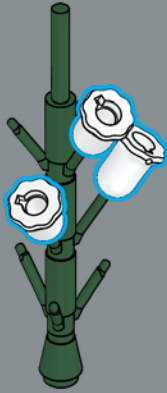

14

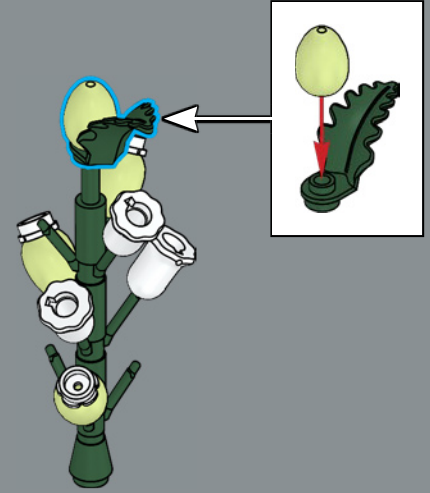

13

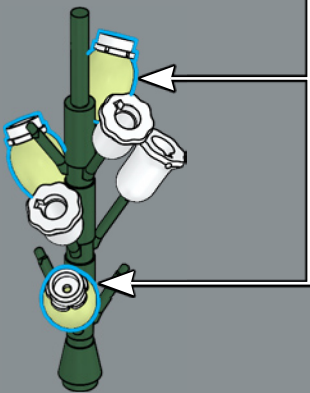
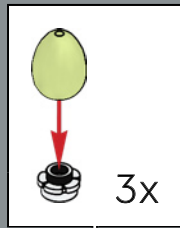

15

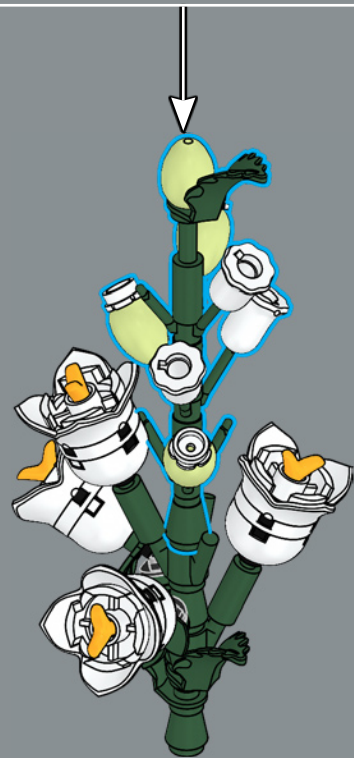

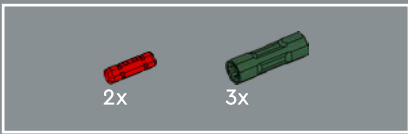

16

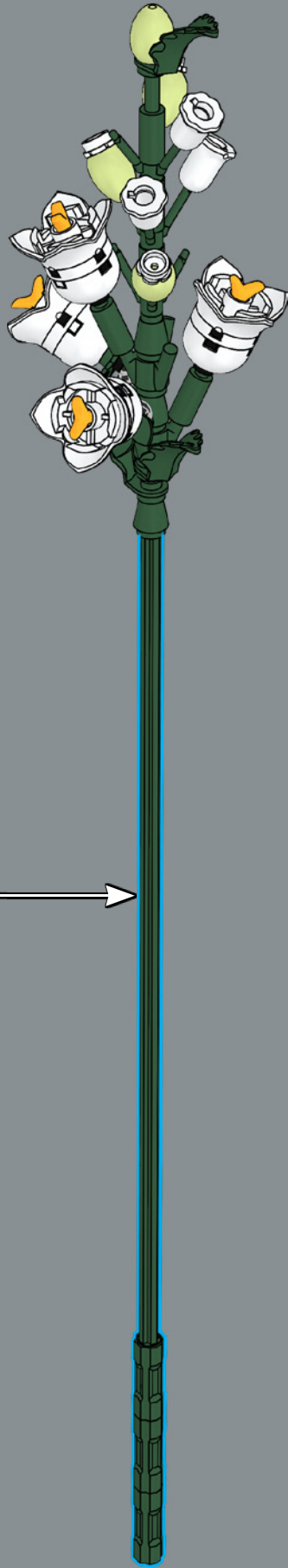
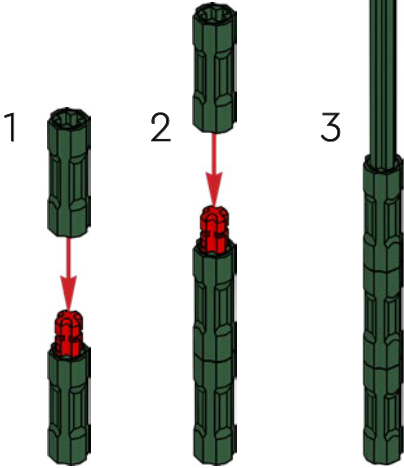
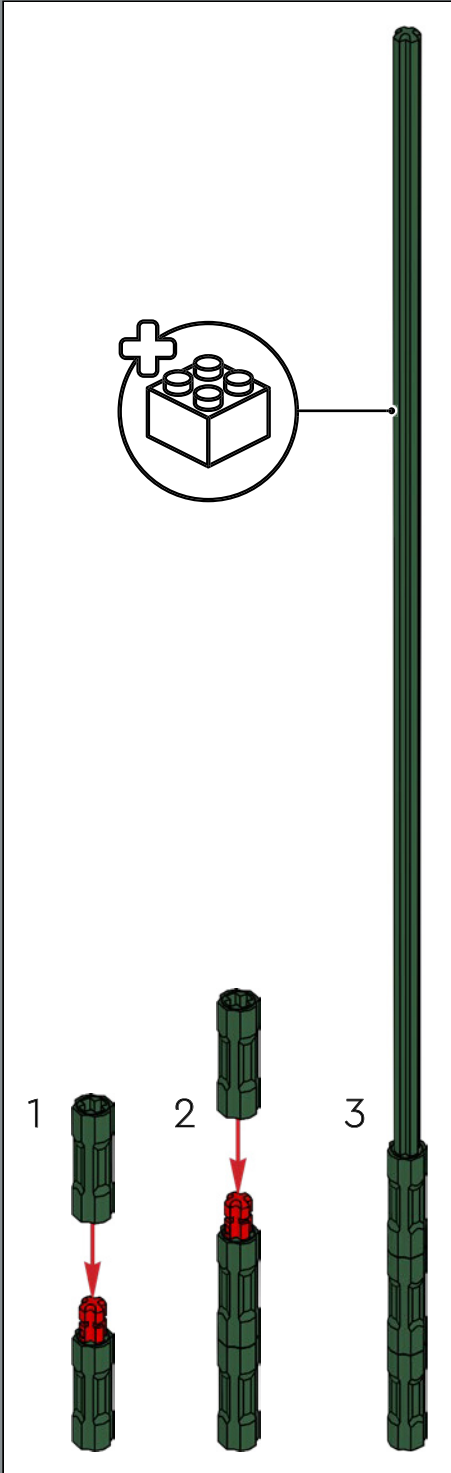



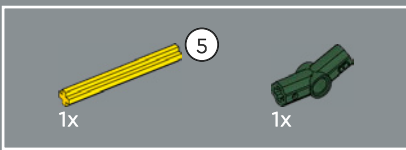

1

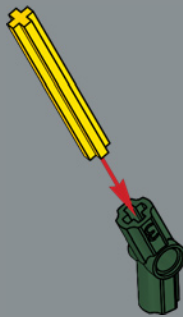

2

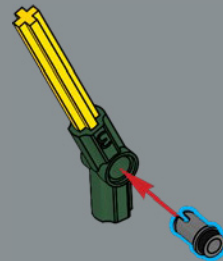

3

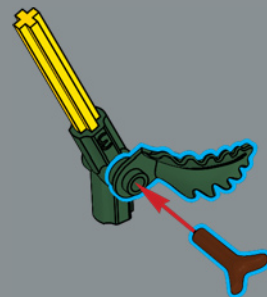

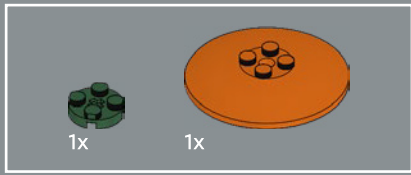

4

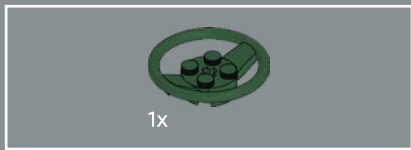
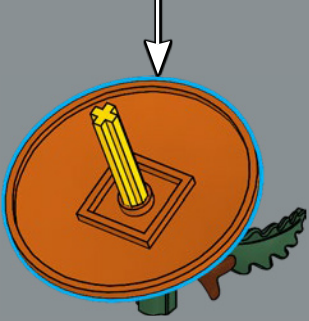
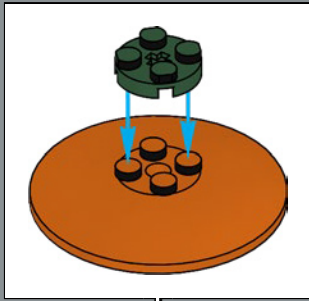

5

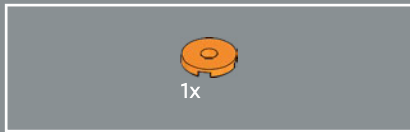
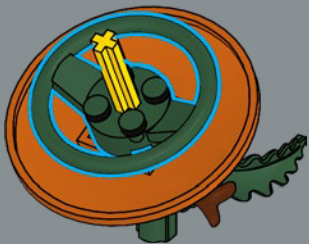

6

This steering wheel, designed for large-scale LEGO® cars, now constructs the center of our LEGO flowers. The minifigure axle head was introduced in 2005 for the LEGO Vikings line.

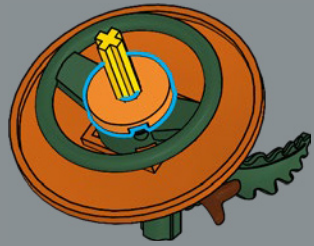

7

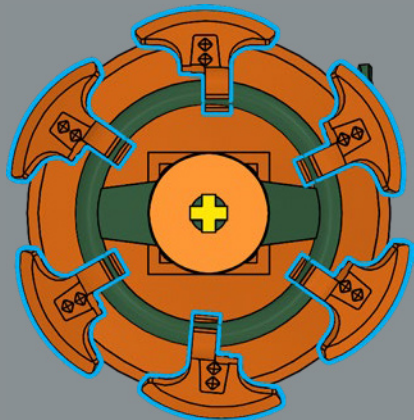



8

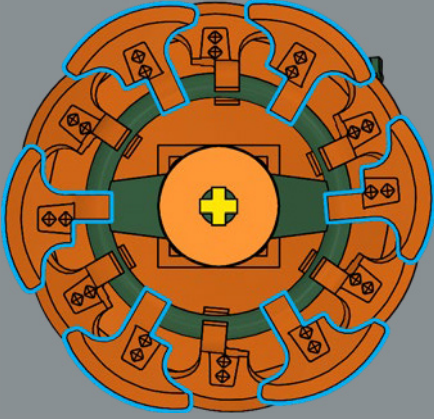

9

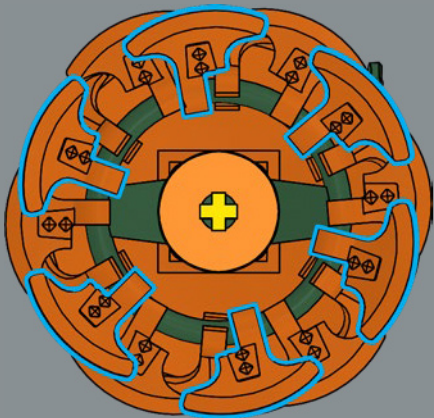

10

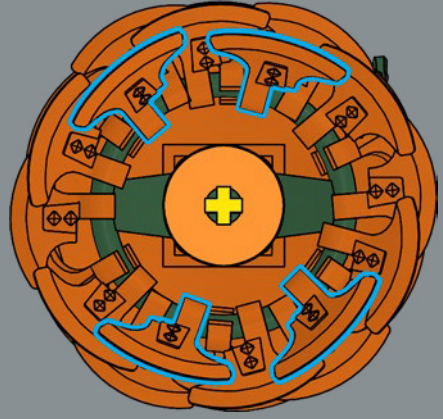

11

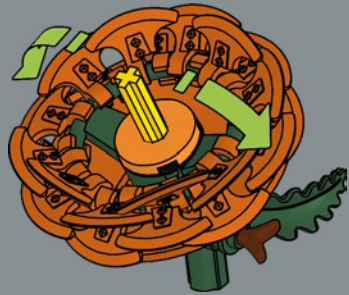

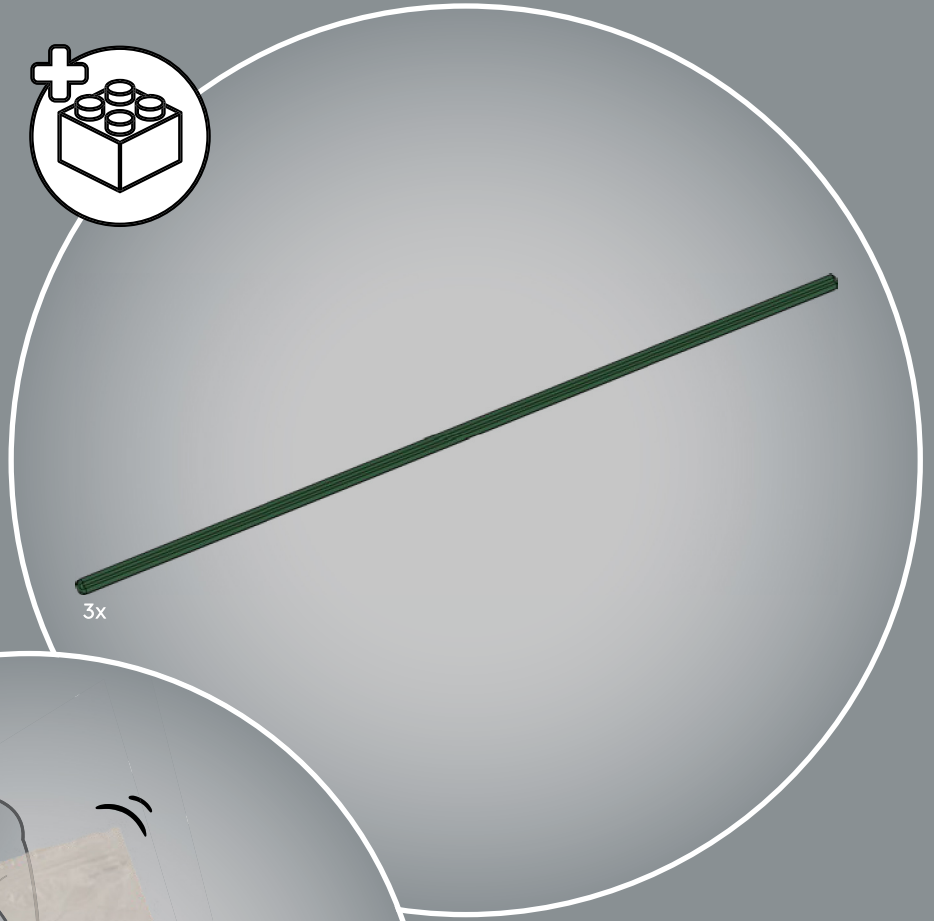
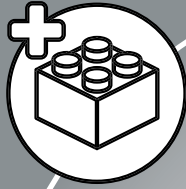

3x



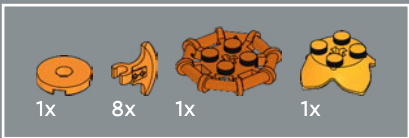

# 12

1

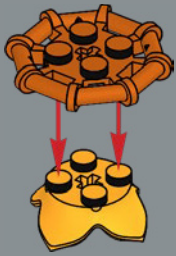

2

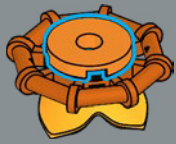

3

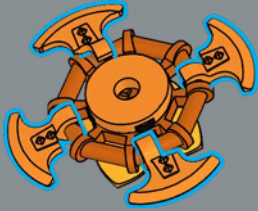

4

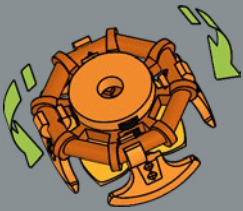

5

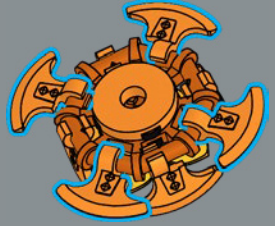

6

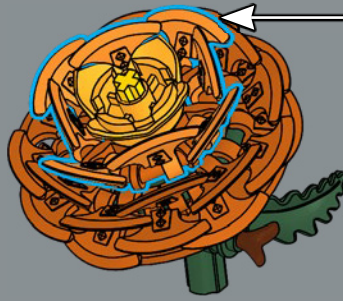
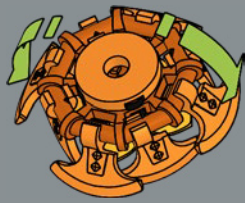

2x

This is, perhaps, the most axes ever used in a LEGO® flower.

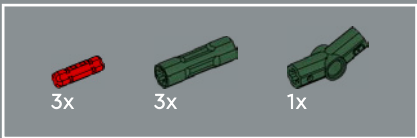

13

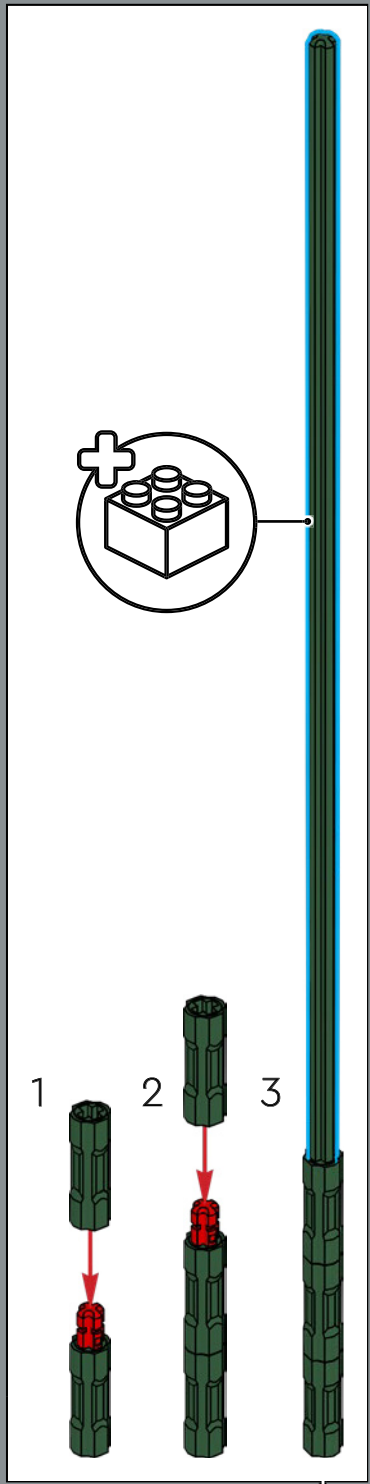
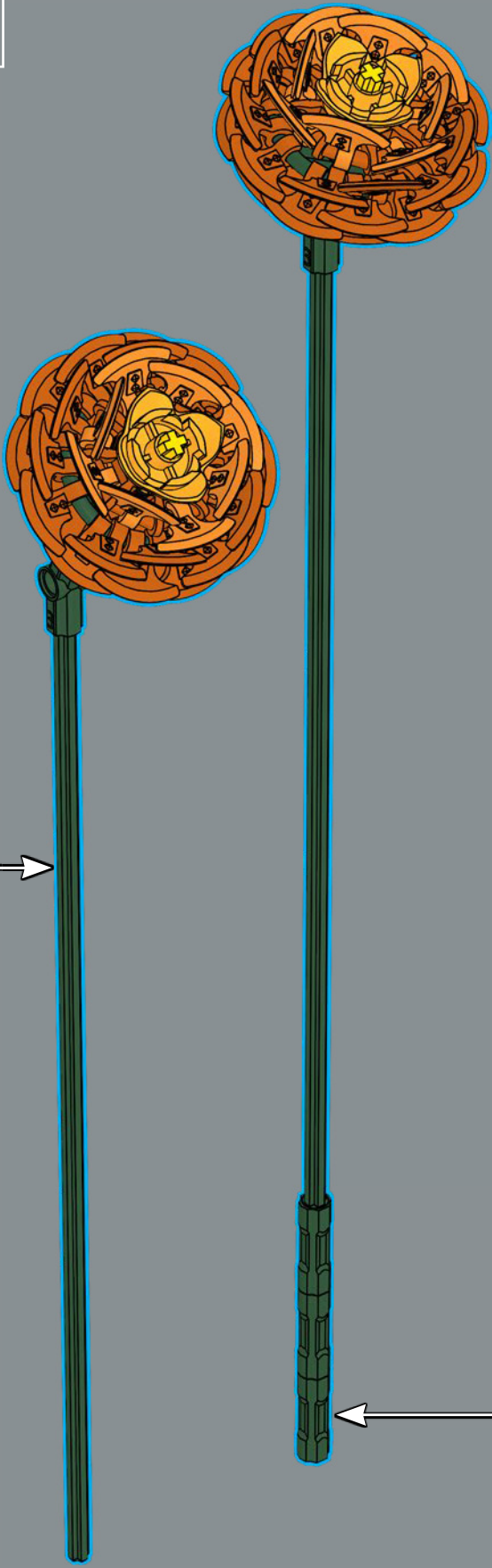
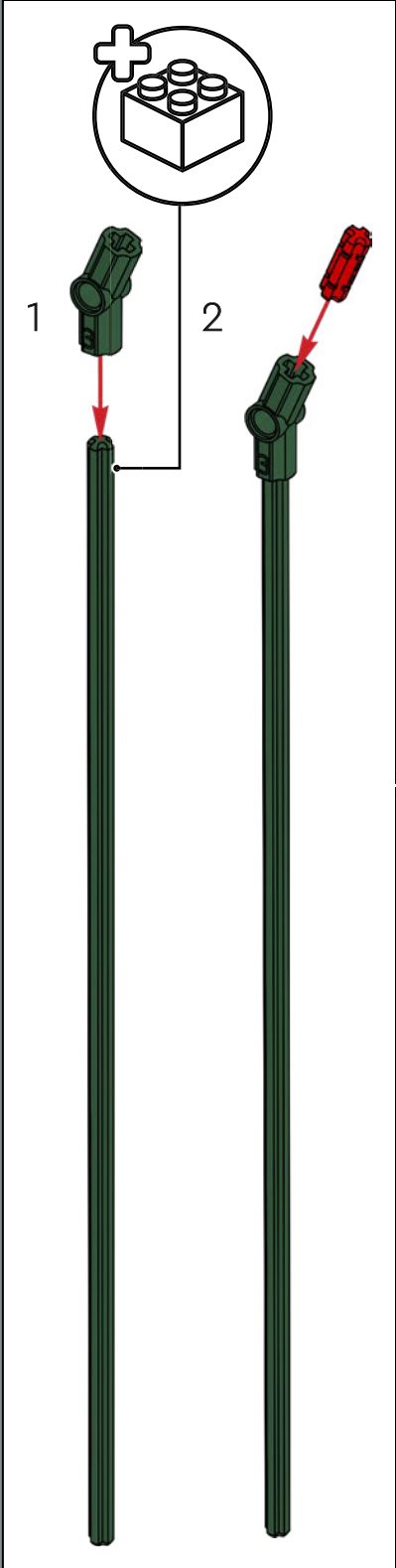



*(Dahlia nymphaea)*

## WATERLILY DAHLIA

Symbols of elegance and grace, the decorative waterlily dahlia blossoms unfold like a luxurious firework display.

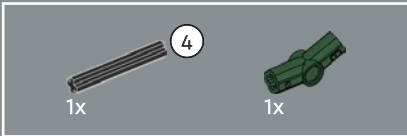
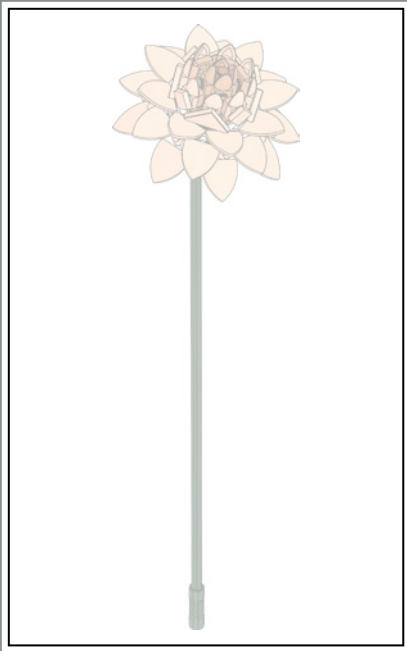

1

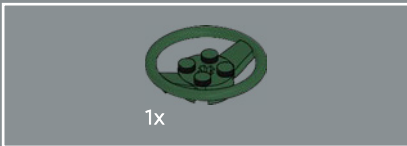
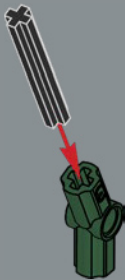

2

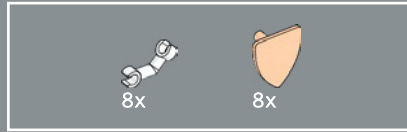
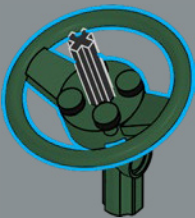

3

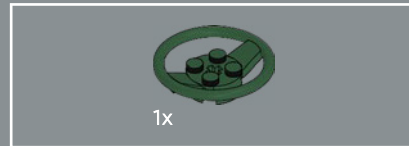
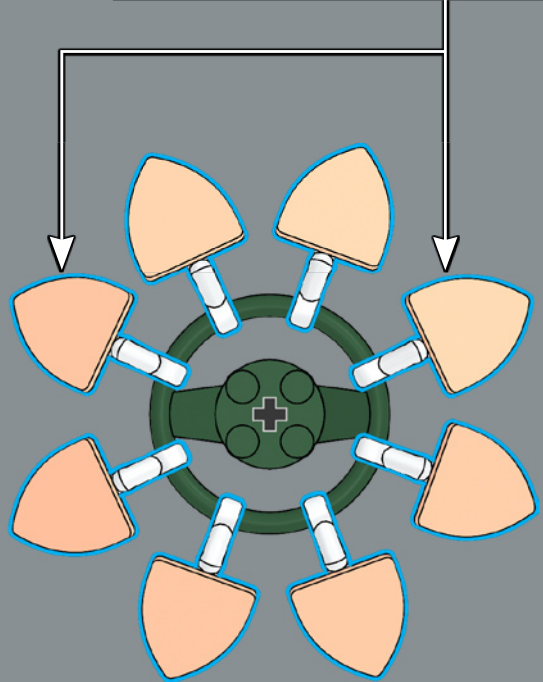
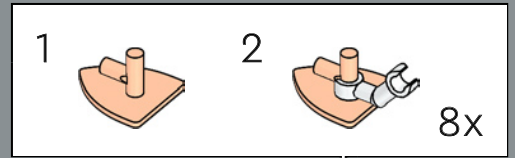

4

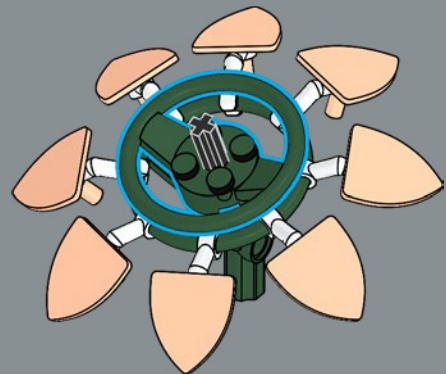



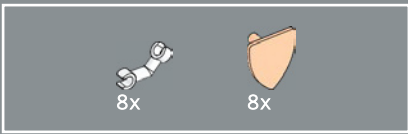

5

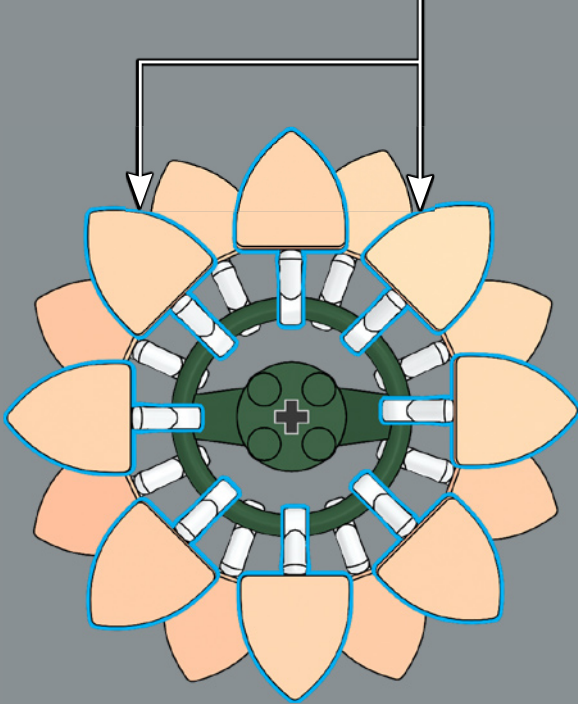
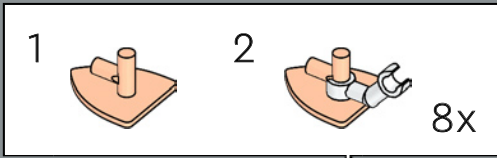

Congratulations! You are now better equipped than our LEGO® knights were when these shields were introduced back in 1978!

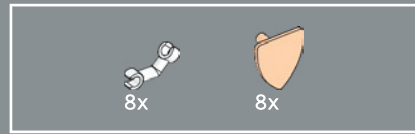

6

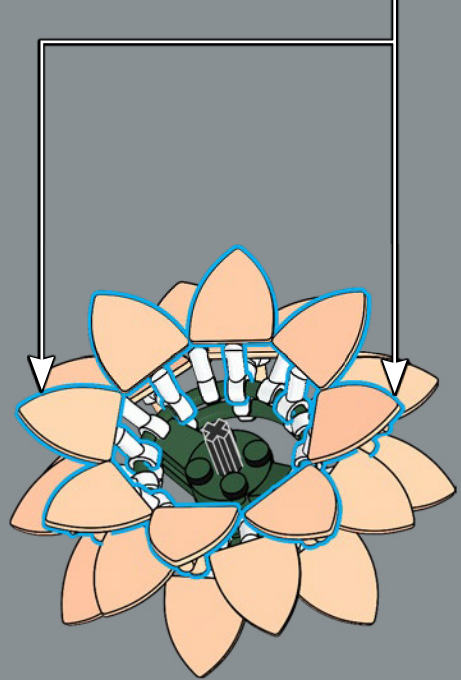
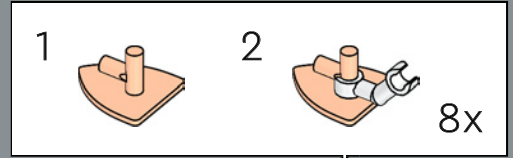

7

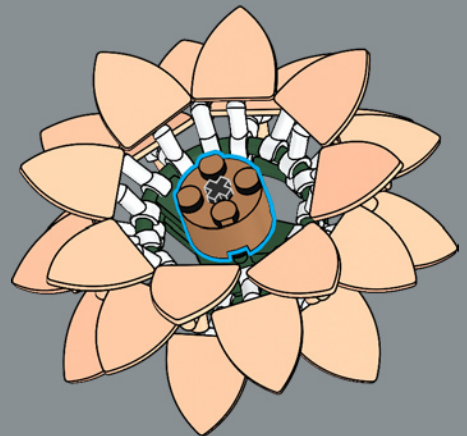

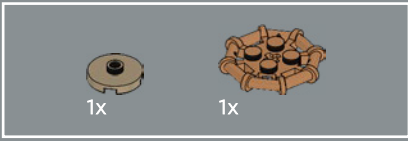

8

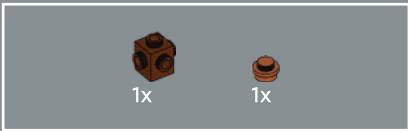
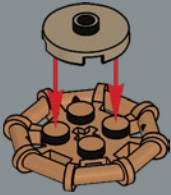

9

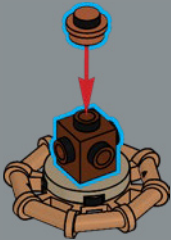

10

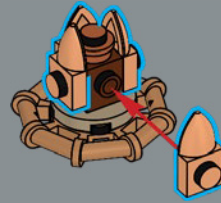

11

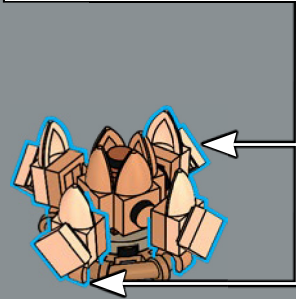
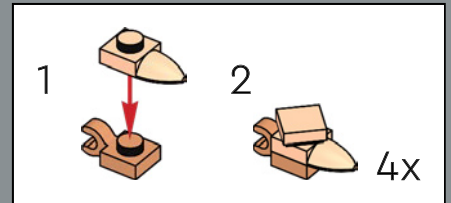



12

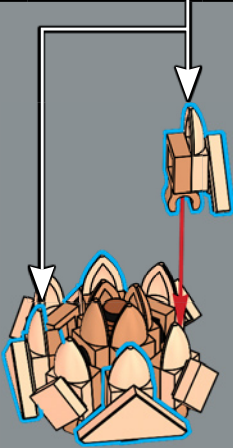
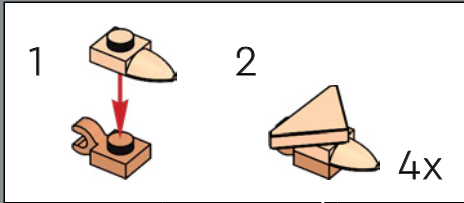

13

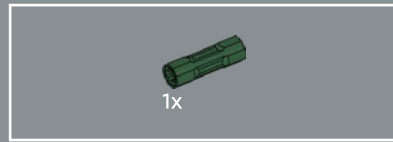
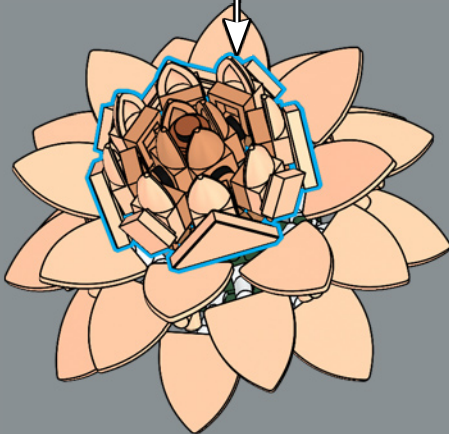

14

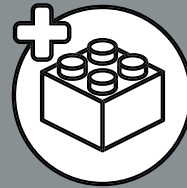
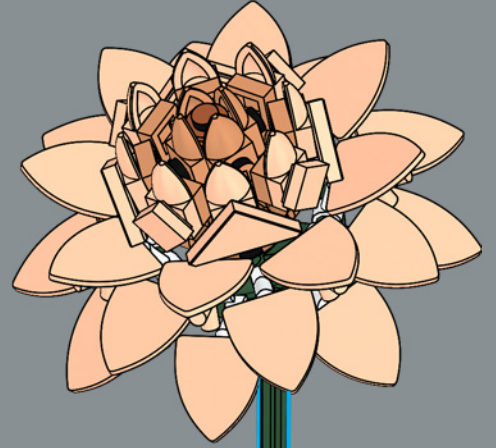



*(Cymbidium)*

## BOAT ORCHID

*Cymbidium* orchids are documented in records from the time of Confucius, around 500 BCE, making them the oldest known cultivated orchid species.

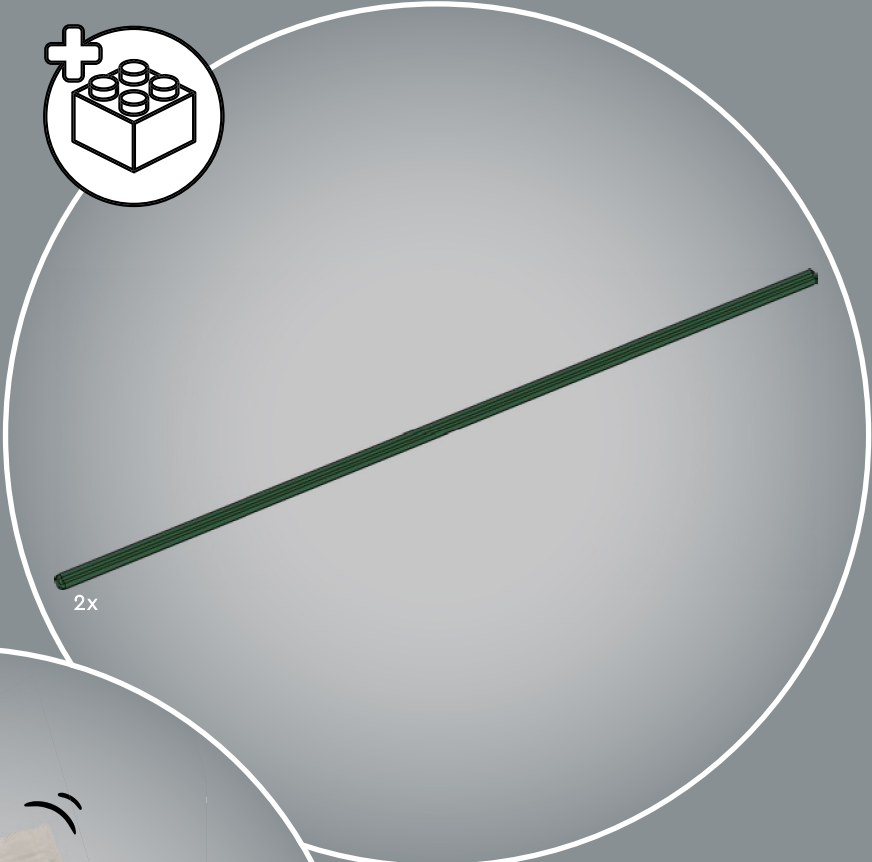
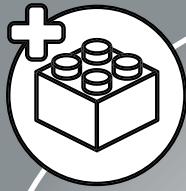

2x



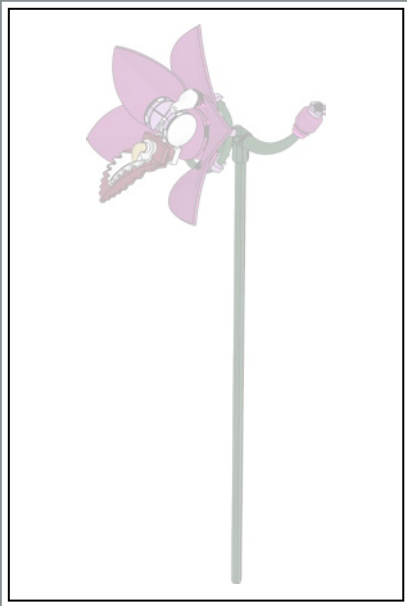

1

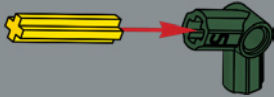

2

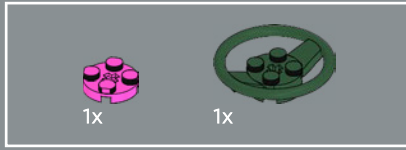
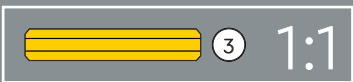
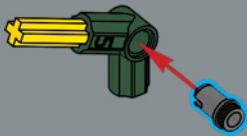

3

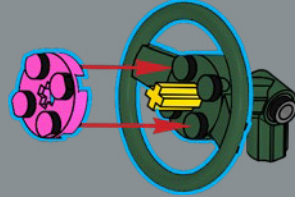

4

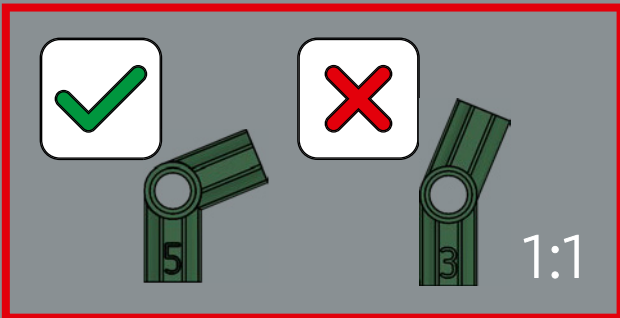
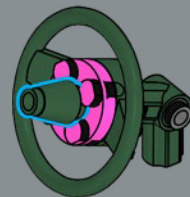

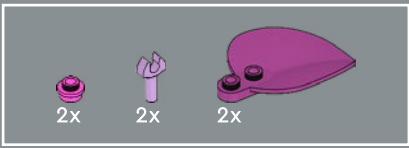

5

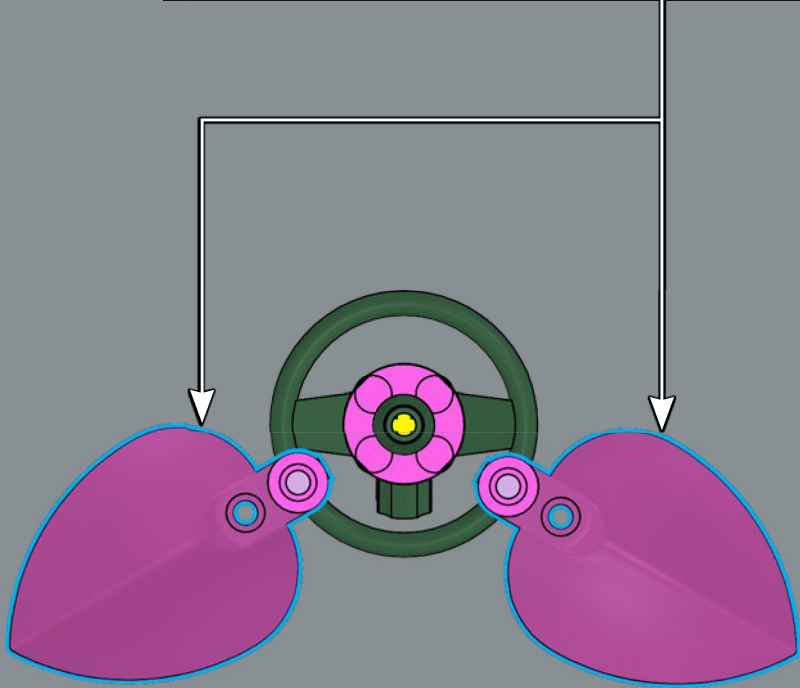
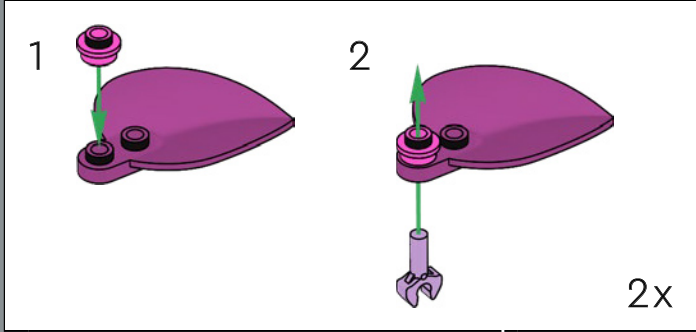



6

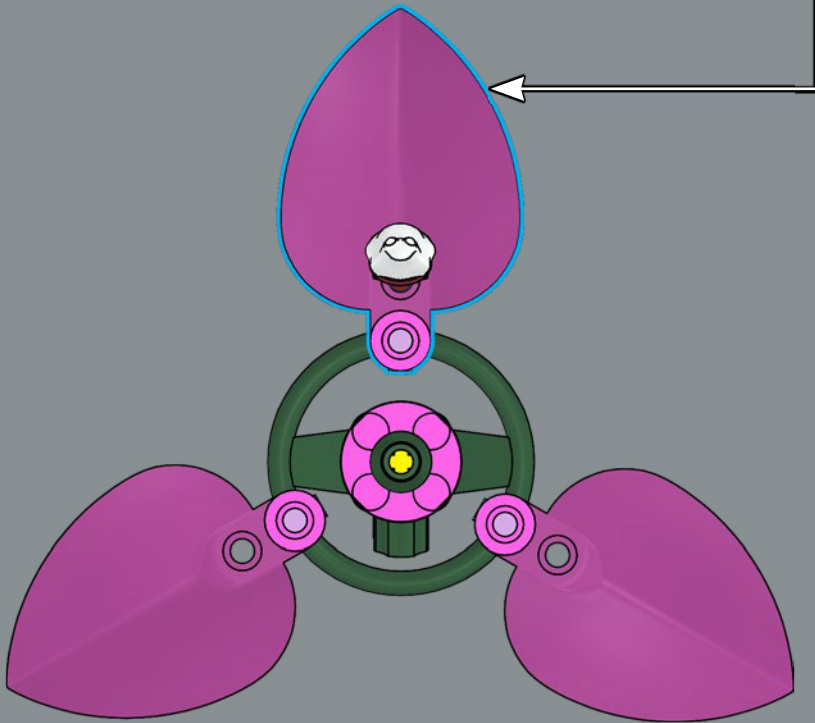
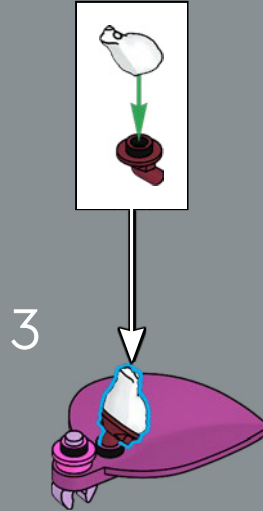
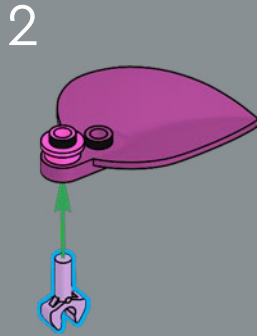
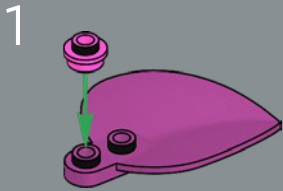

Even a LEGO® frog can be used to mimic parts of a flower!



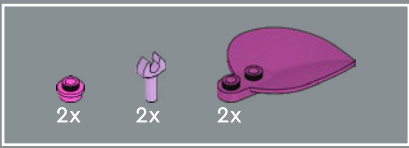

7

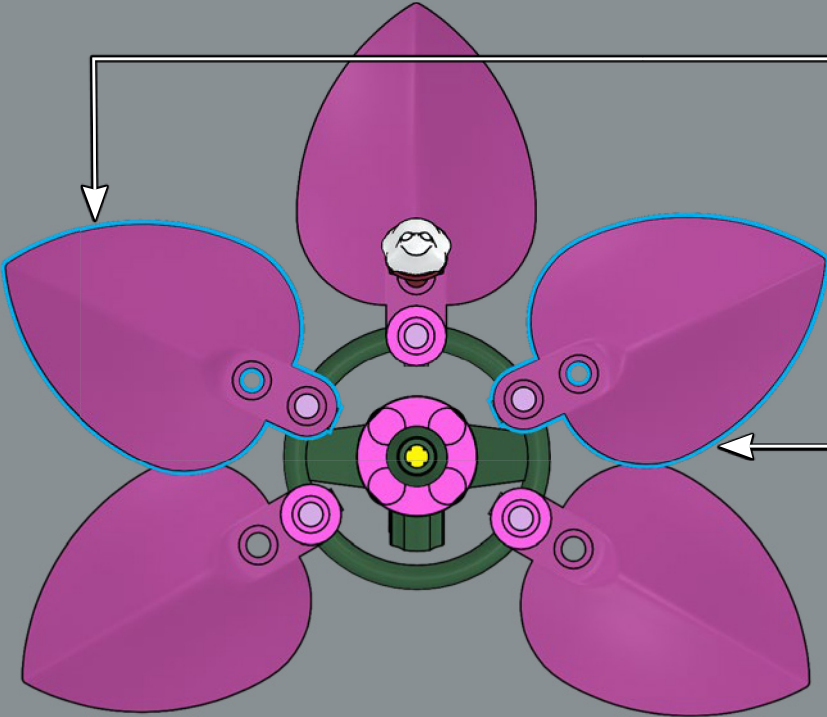
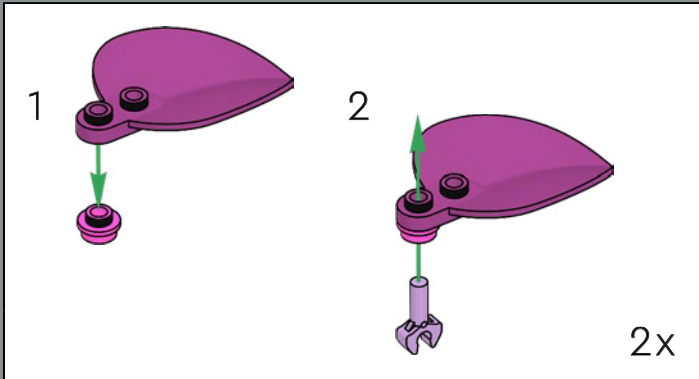

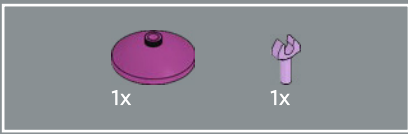

8

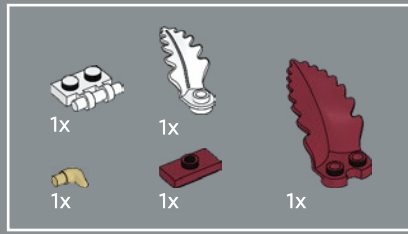
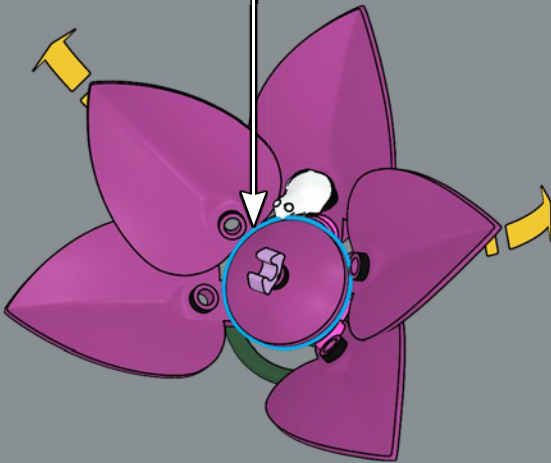
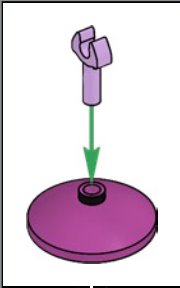

9

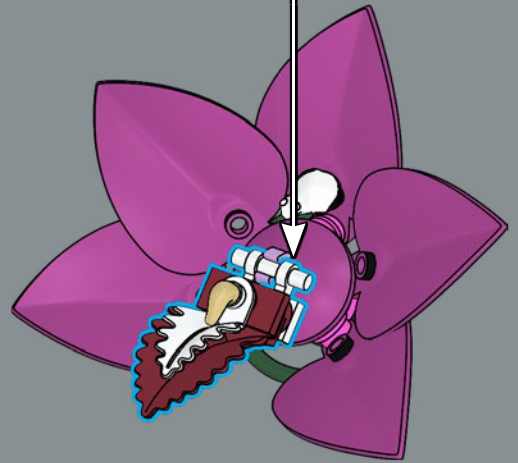
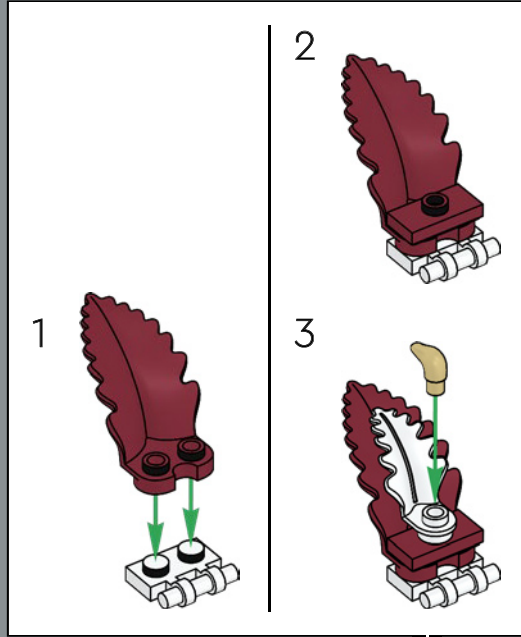

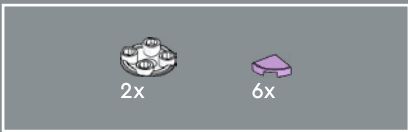

10

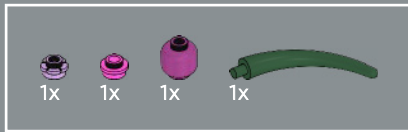
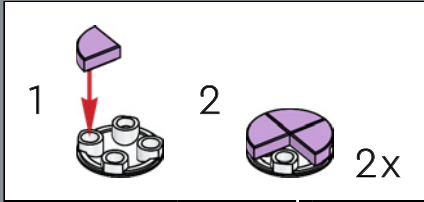

11

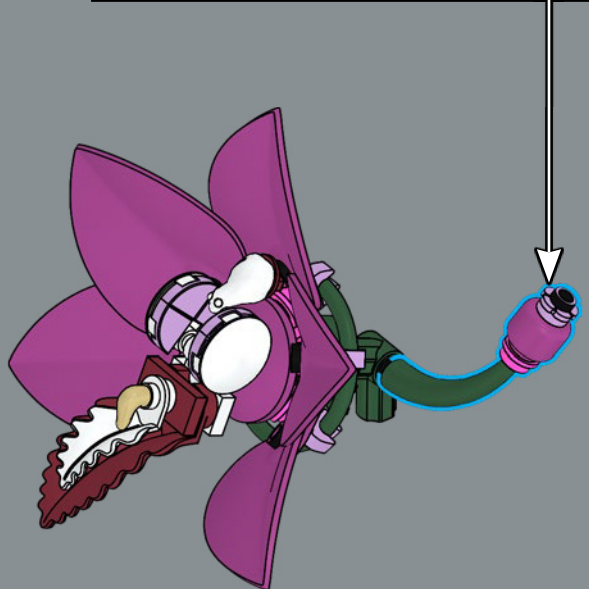
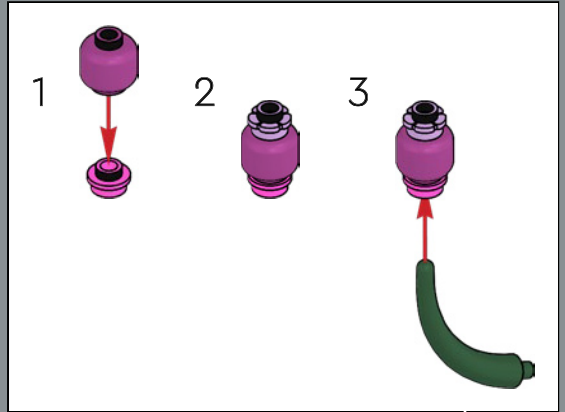

12

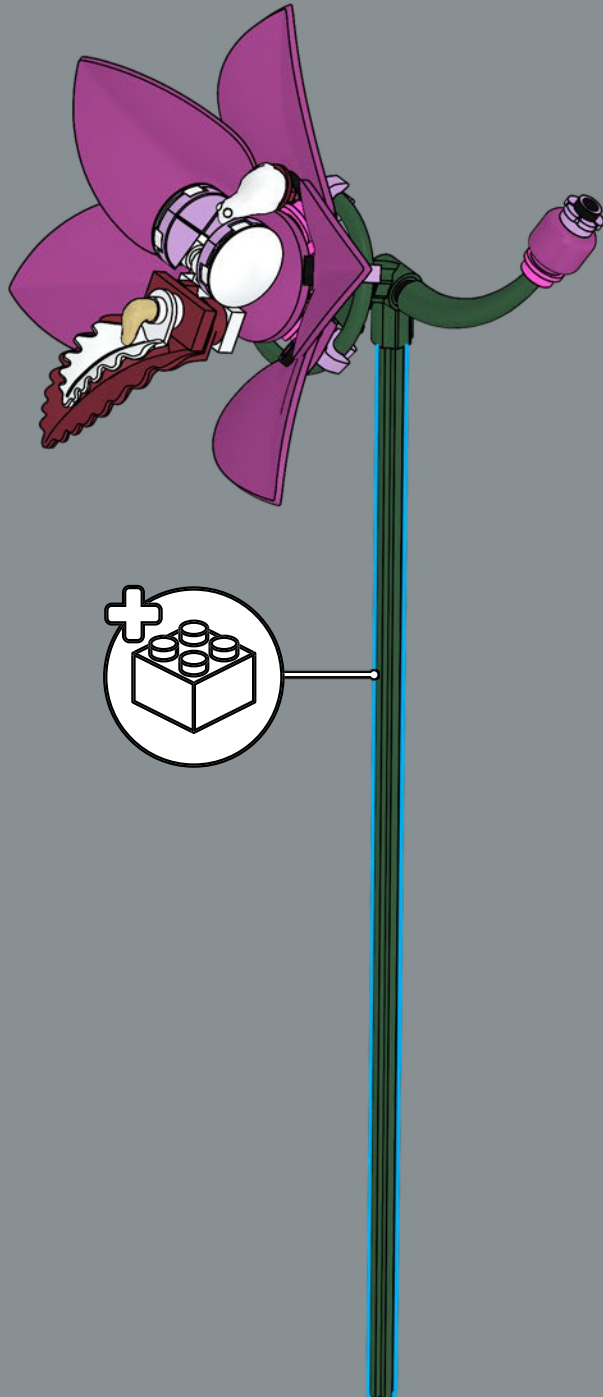

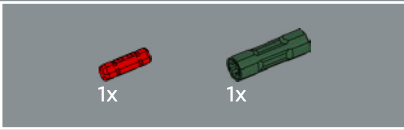
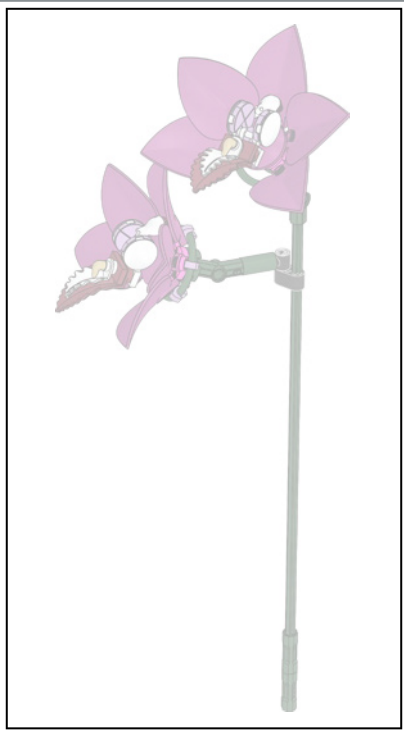

13



14



15



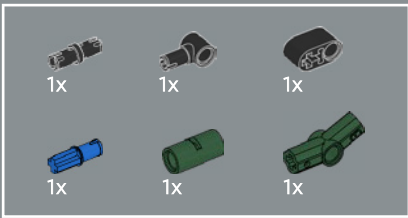

16

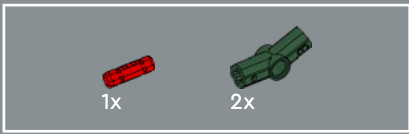
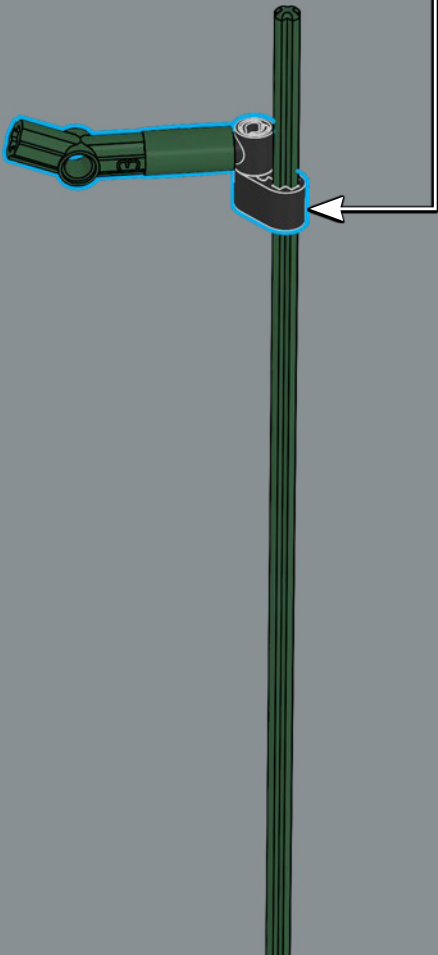
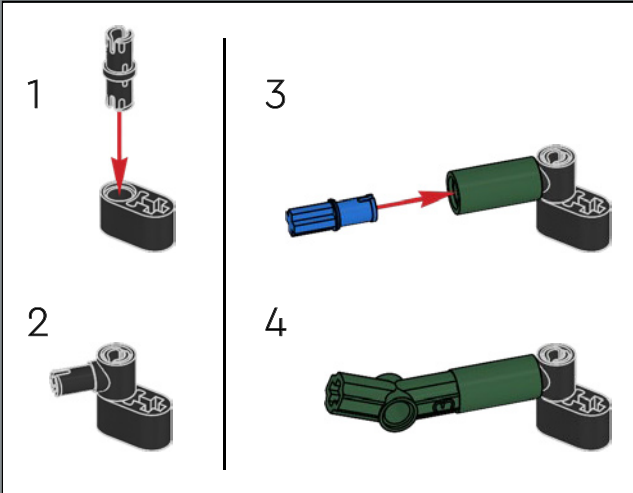

17

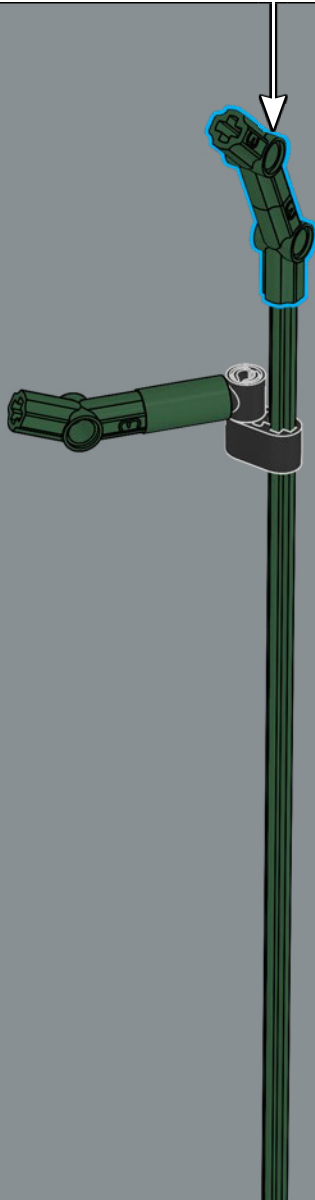
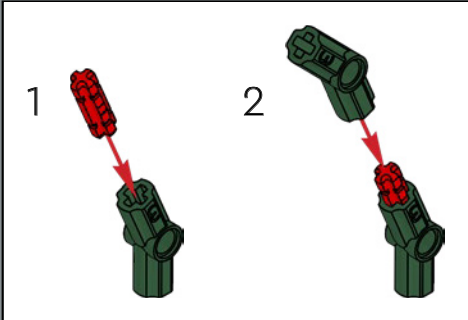

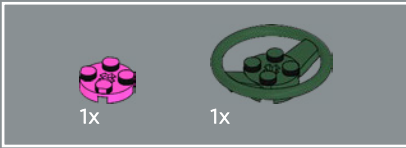
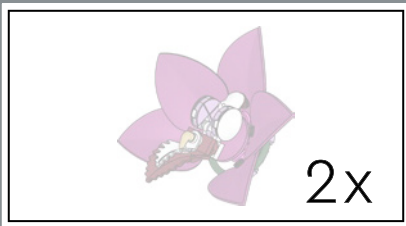

18

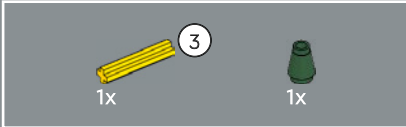
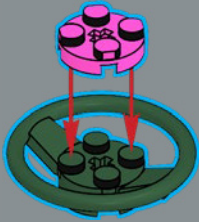

19

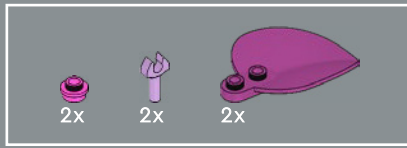
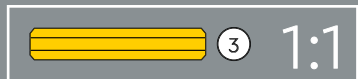
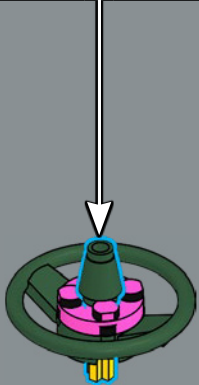
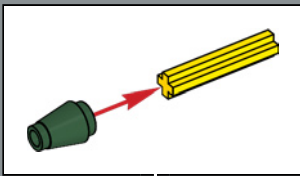

20

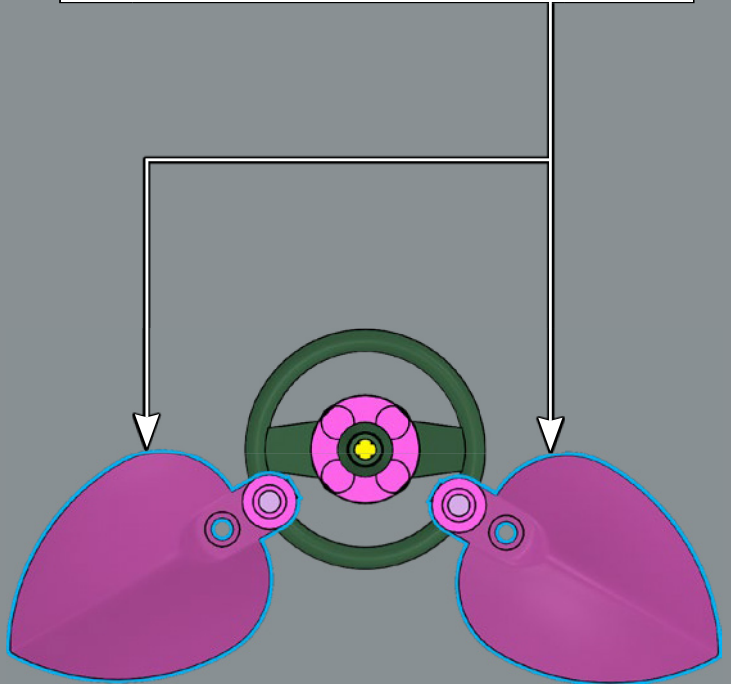
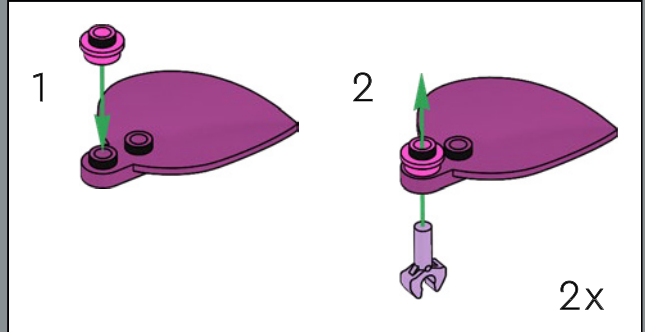



21

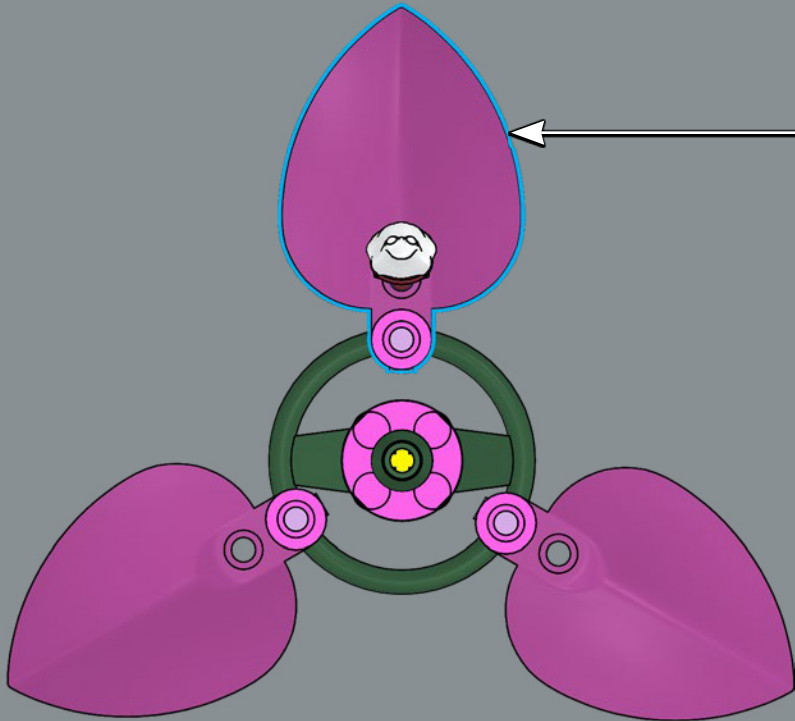
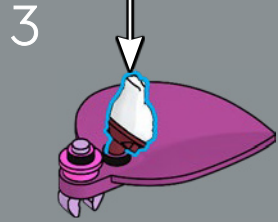
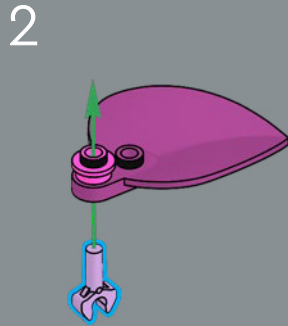
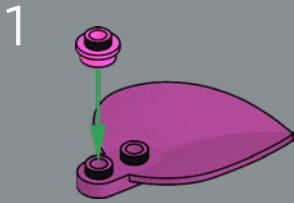



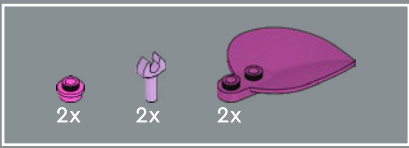

22

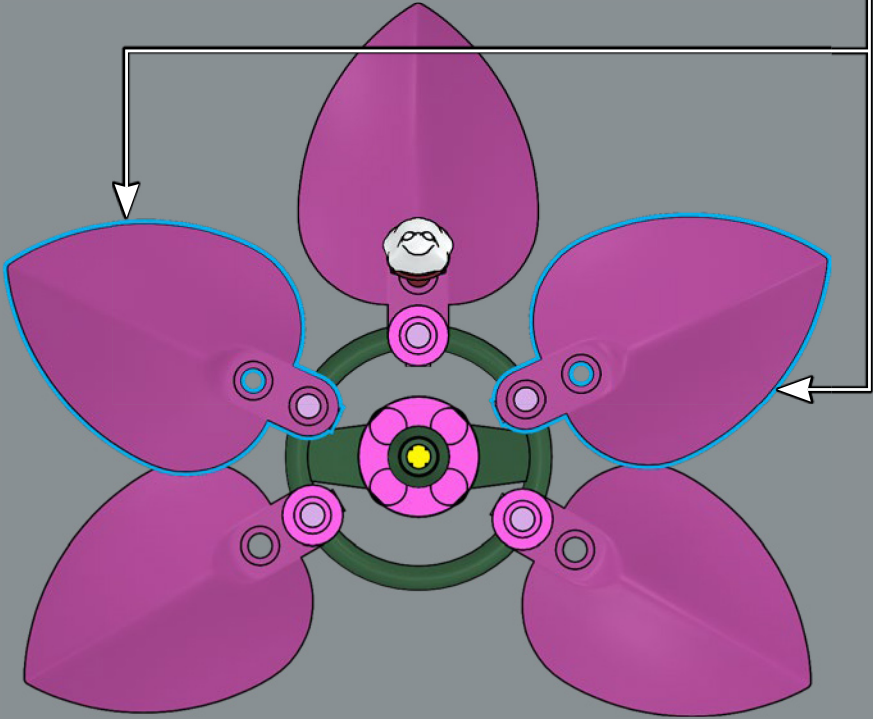
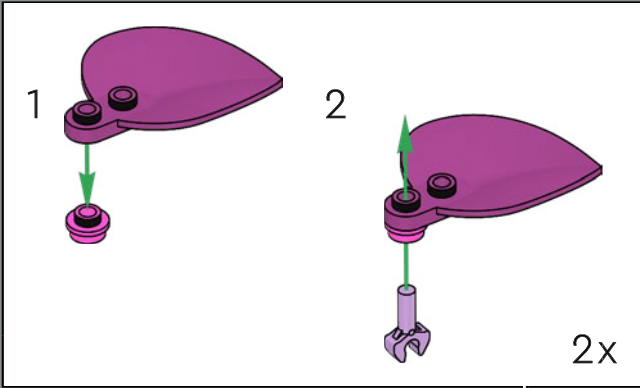

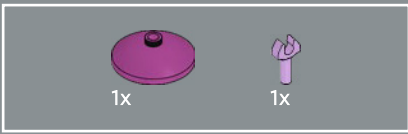

23

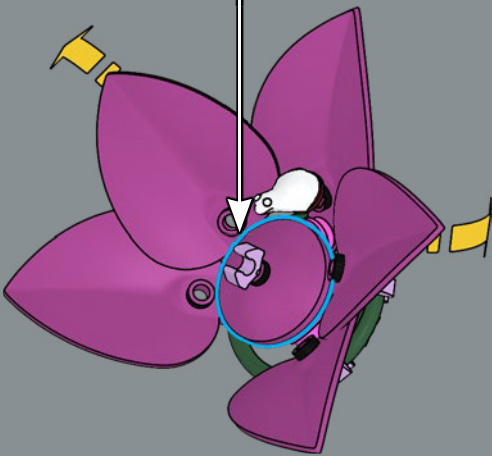
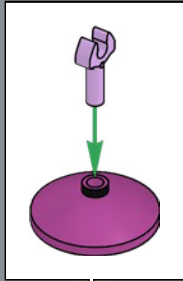

24

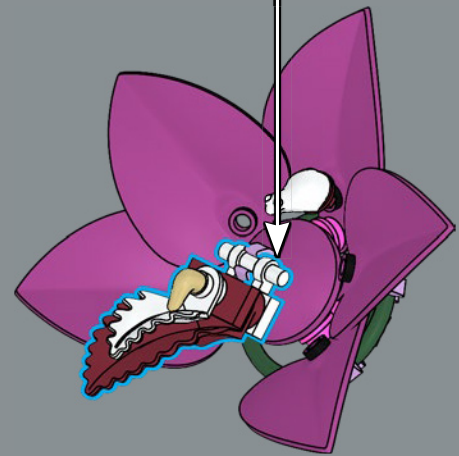
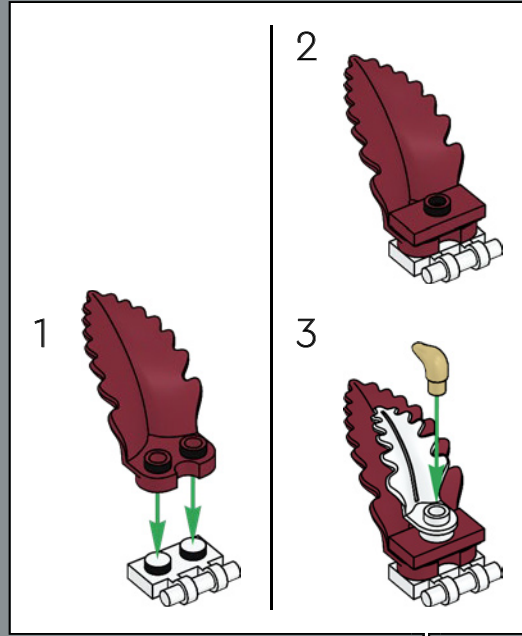

A plant built from plants? The labellum of this orchid is built using two LEGO® fern leaves.

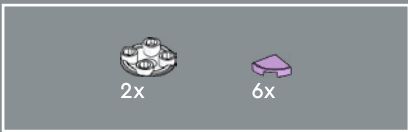

25

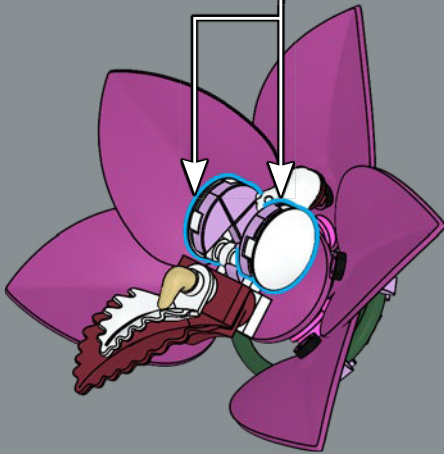
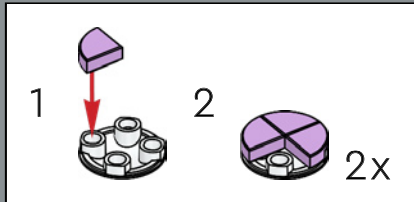

2x

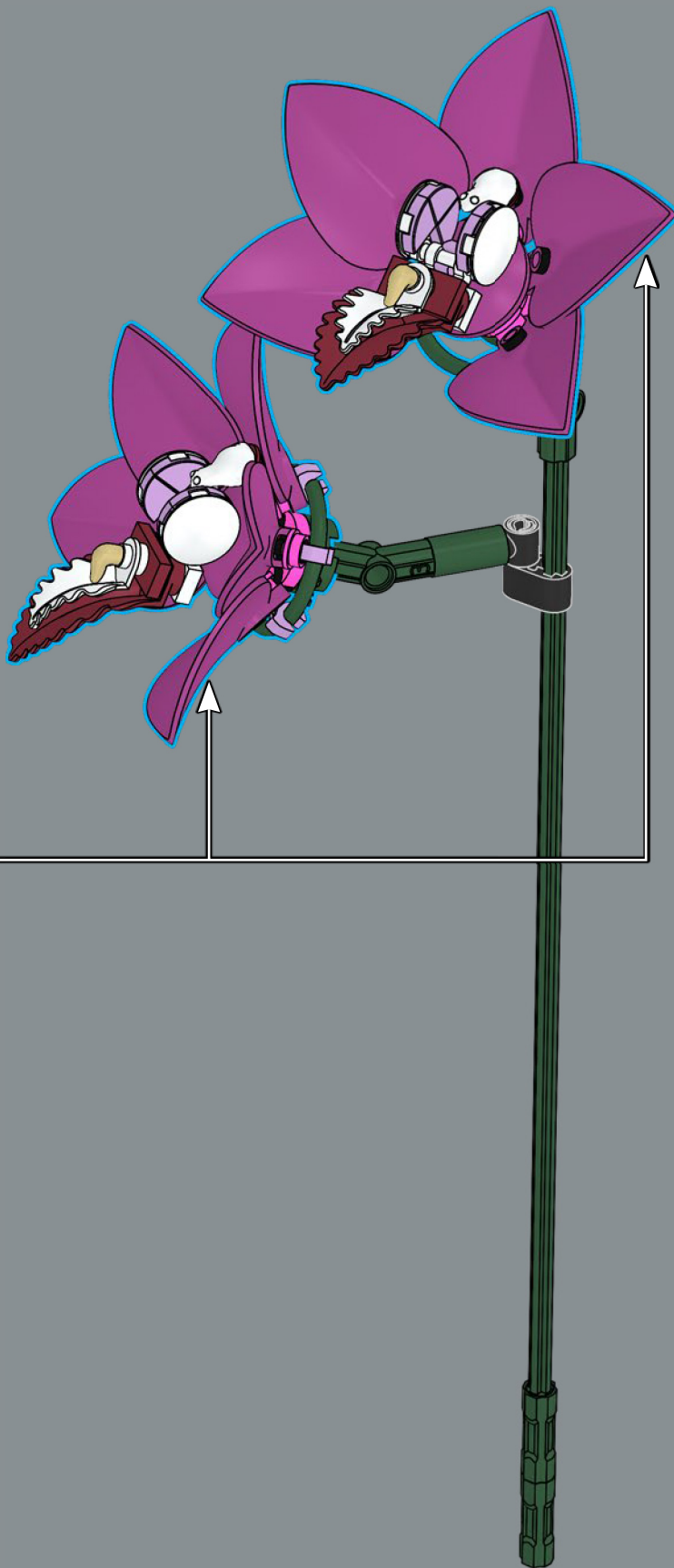

# Expand your bouquet

Ready to discover new species of LEGO® flowers? Find more flowers and plants in our Botanicals series and be inspired to mix your own bouquets and floral arrangements.



Discover more blooming creative tips with your LEGO® Insiders account on

[LEGO.com/Botanicals-exclusive](https://LEGO.com/Botanicals-exclusive)

4x 6206149	1x 6279875	3x 6498565	3x 6510194	44x 6525752	22x 4516546	4x 6398468
18x 6439046	1x 6282140	1x 6349342	3x 6092597	2x 6510511	6x 6316692	18x 6240465
3x 6298930	1x 6265091	1x 6515241	3x 6529631	2x 6483785	4x 6267047	4x 4211508
2x 6525773	1x 370526	5x 6525789	4x 6454729	8x 6517933	8x 6366184	1x 4502595
3x 6525849	3x 6315782	10x 6344177	1x 6133765	4x 6480394	6x 6395635	18x 6087084
18x 6259700	16x 6525753	15x 6330196	3x 6451002	8x 6525786	4x 6265702	8x 6525783
8x 6347293	4x 6147052	1x 6507841	2x 6078605	4x 6480394	2x 6310174	8x 6525783
24x 6252200	4x 6147052	7x 6329283	2x 6349130	8x 6525786	16x 6230582	36x 4142865
6x 4278271	1x 6493246	1x 6512537	2x 6078605	24x 6525771	3x 6326495	3x 4206482
4x 403201	3x 6217587	2x 6529632	16x 6525770	2x 6525767	3x 6525769	3x 4206482
4x 6429053	15x 6519960	4x 6525766	10x 6474602	4x 6480369	3x 6525790	13x 6130007
3x 6439714	2x 6270111	6x 6400754	4x 6328339	1x 6454167	8x 6296041	2x 6130008
3x 4140583	1x 6132767	4x 6525927	11x 6474604	1x 6454167	8x 6517912	8x 6510193
4x 6468789	6x 6522274	2x 6035029	10x 6360112	1x 6177189	8x 6456642	1x 6104209
3x 6368620	14x 6230571	7x 6447541	12x 6468072	1x 6214235	4x 6096682	1x 6104209
4x 6525785	11x 6411591		12x 6526753	18x 6439052	2x 6525787	18x 6251854
8x 6525784			6x 6348251			

4

3

5

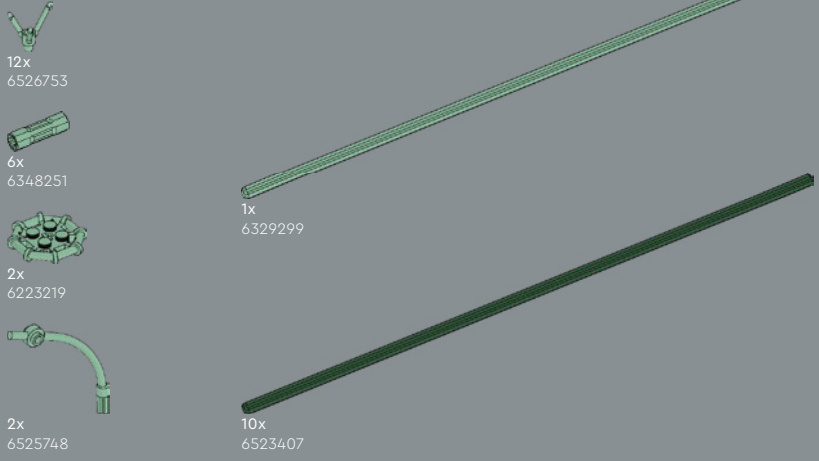



# YOU COULD WIN



## YOU COULD WIN

Your feedback will help shape the future development of this product series.

Visit:

## DU KÖNNTEST GEWINNEN

Dein Feedback trägt zur Weiterentwicklung dieser Produktreihe bei.

Geh auf:

## VOUS POURRIEZ GAGNER

Vos commentaires nous aideront à concevoir les futurs produits de cette gamme.

Visitez :

## POTRESTI VINCERE TU

La tua opinione ci aiuterà a migliorare la creazione futura di questa linea di prodotti.

Visita:

## PUEDES GANAR

Tu opinión contribuirá al futuro de esta serie de productos.

Visita:

## 轻松获奖

您的反馈将有助于我们在今后改进本产品系列。

请访问:

---

# LEGO.com/productfeedback

---

You also have the chance to win a LEGO® set.

Terms and conditions apply.\*

Außerdem hast du die Chance, ein LEGO® Set zu gewinnen.

Es gelten die Teilnahmebedingungen.\*

Vous pourriez également gagner un ensemble LEGO®.

Des conditions s'appliquent.\*

Hai anche la possibilità di vincere un set LEGO®.

Termini e condizioni sono applicabili.\*

También tienes la oportunidad de ganar un set LEGO®.

Aplican términos y condiciones.\*

您还有机会赢取乐高®套装。

条款和条件适用。\*

\*LEGO.com/productfeedback-terms

