

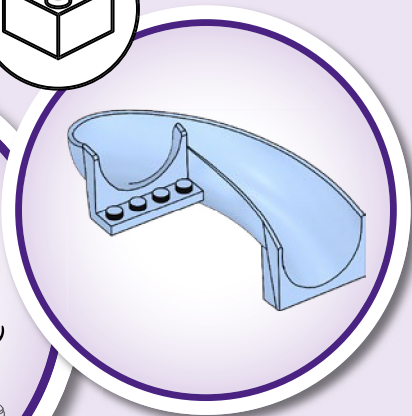

DREAMWORKS
**GABBY'S
DOLLHOUSE**

10796

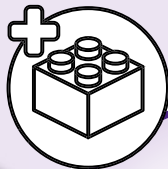



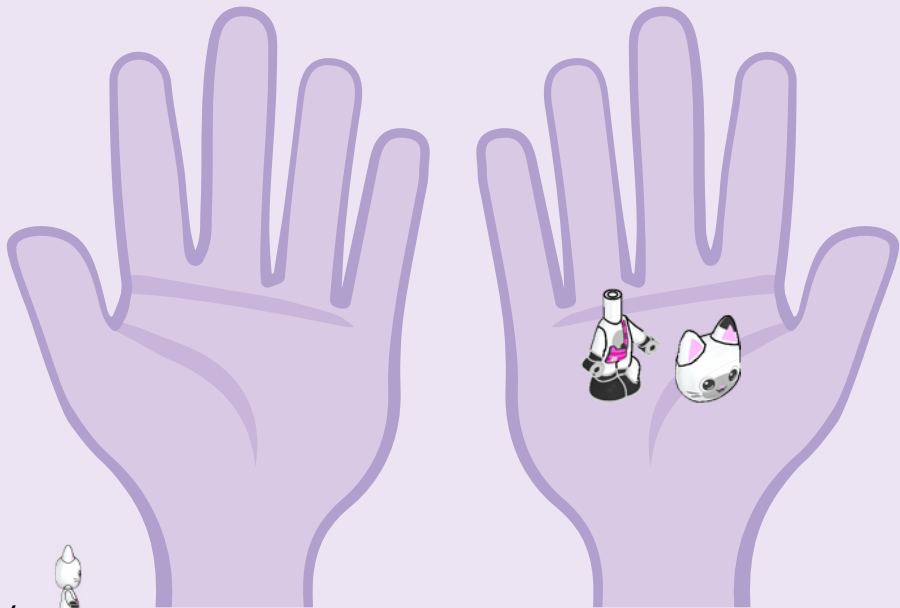

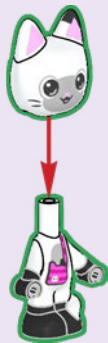





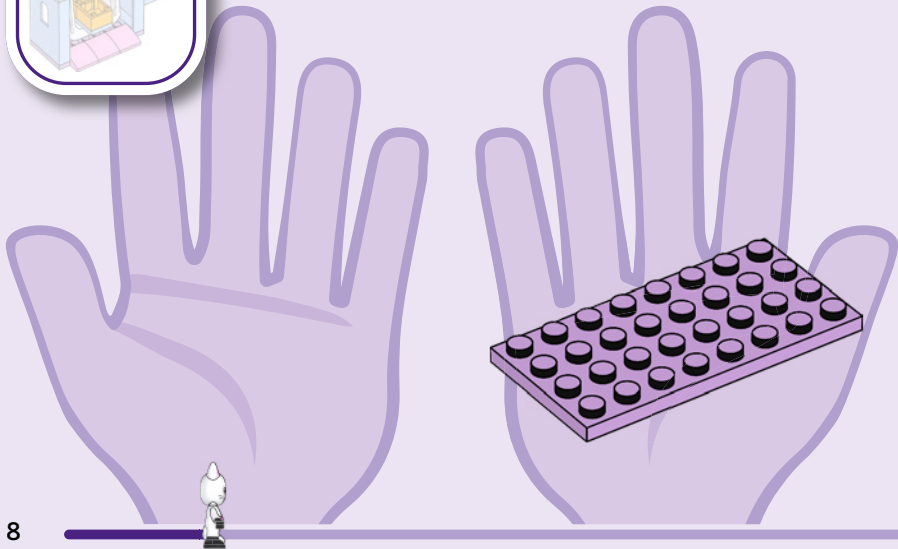

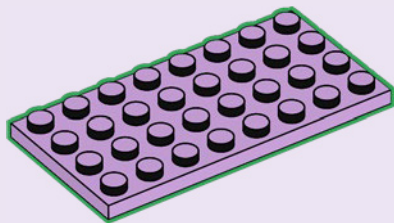

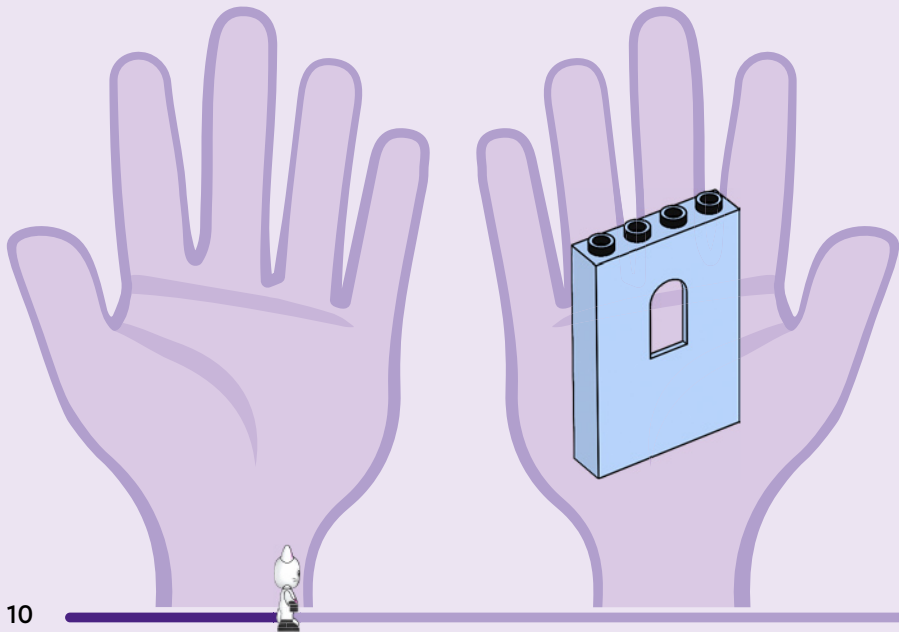

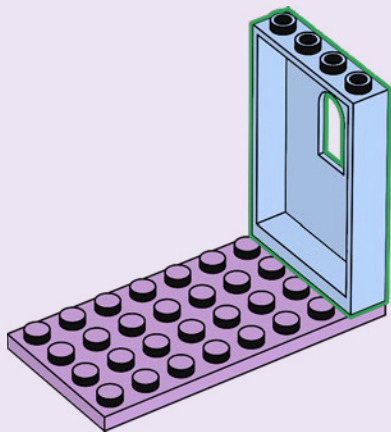

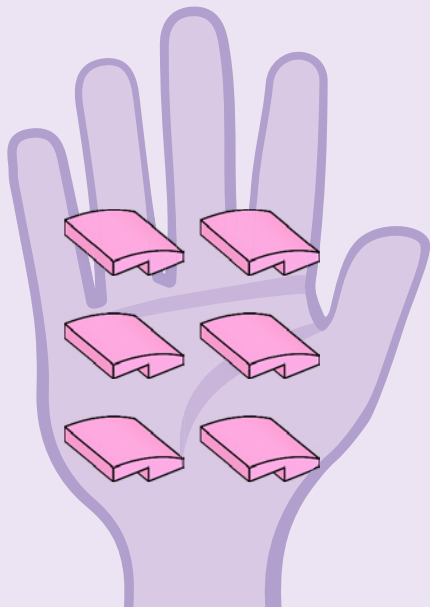

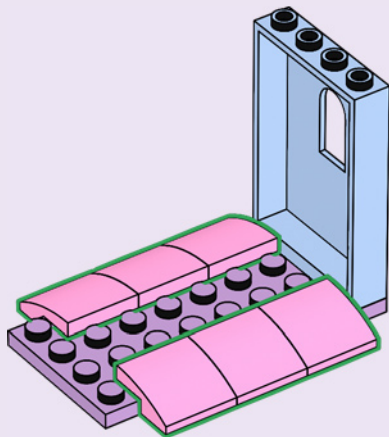

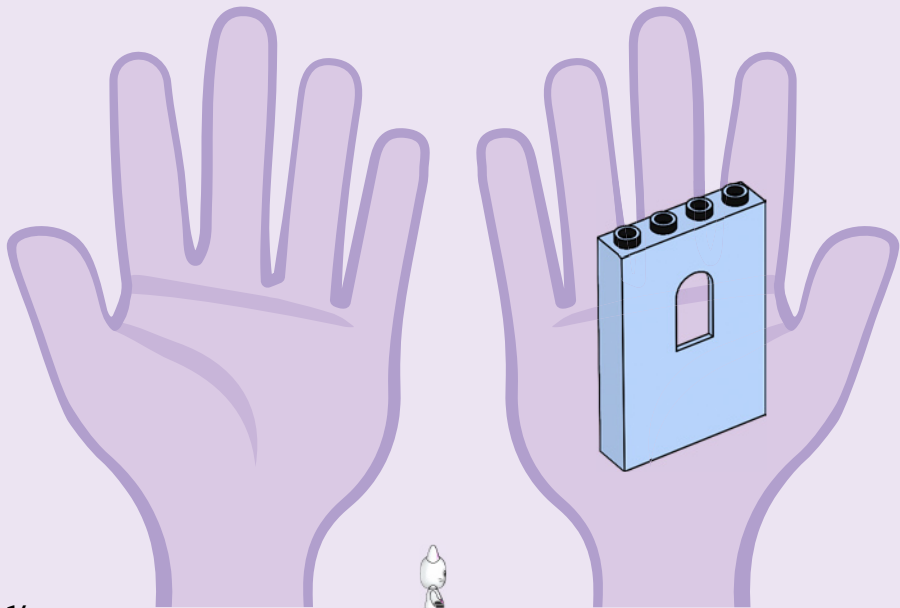

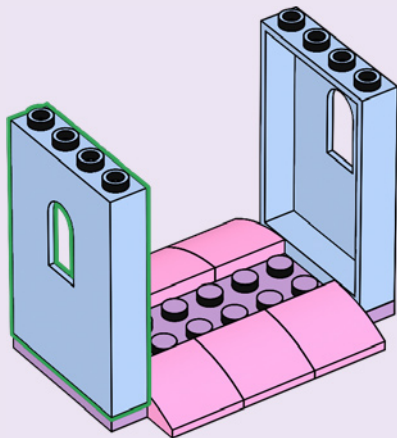

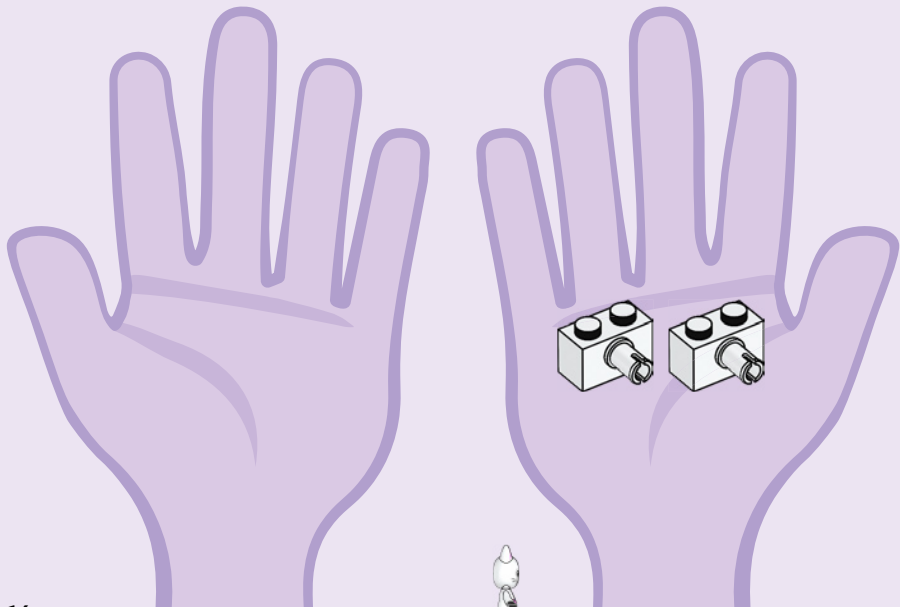

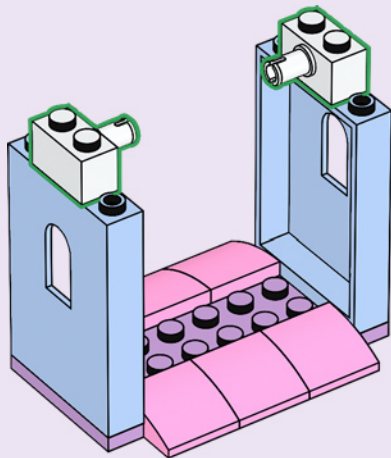

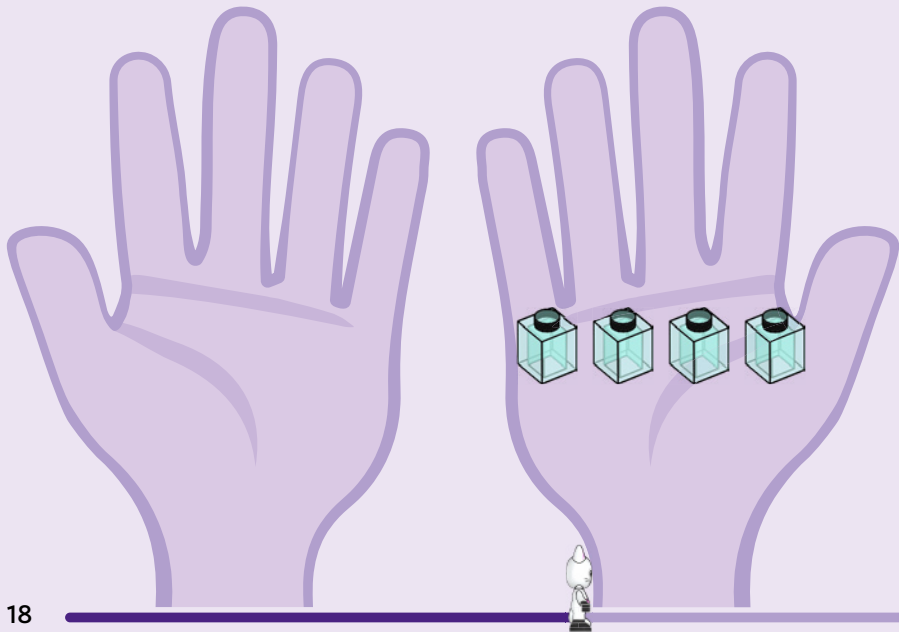

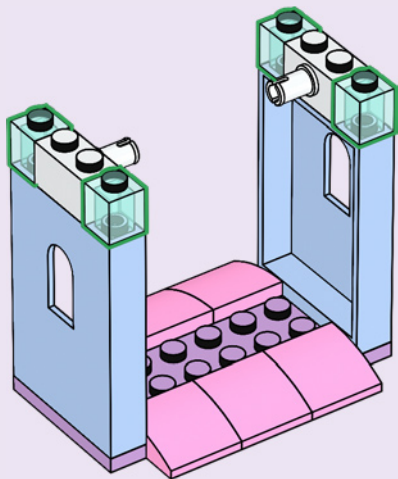

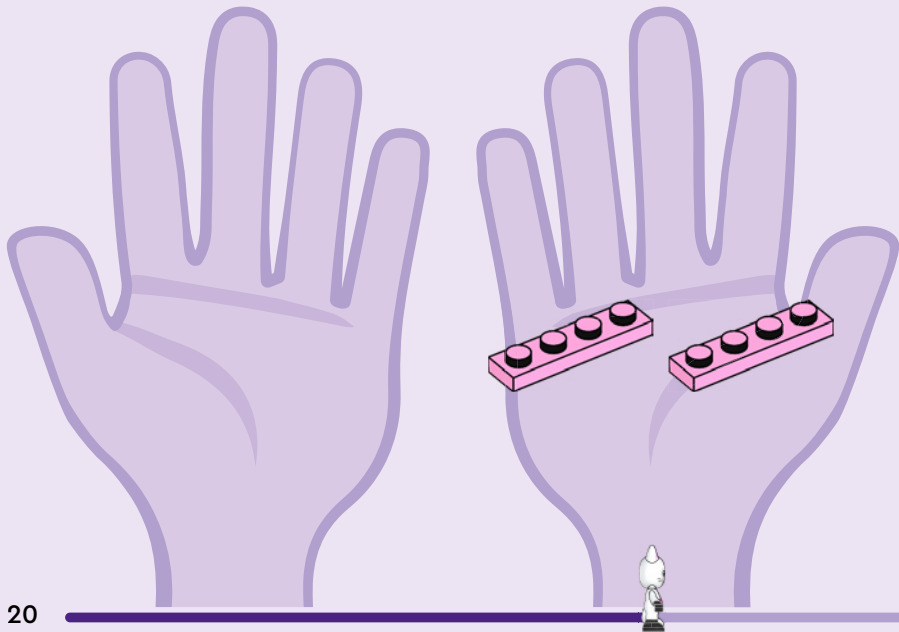

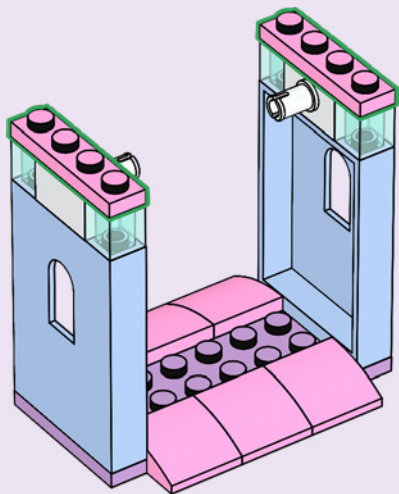

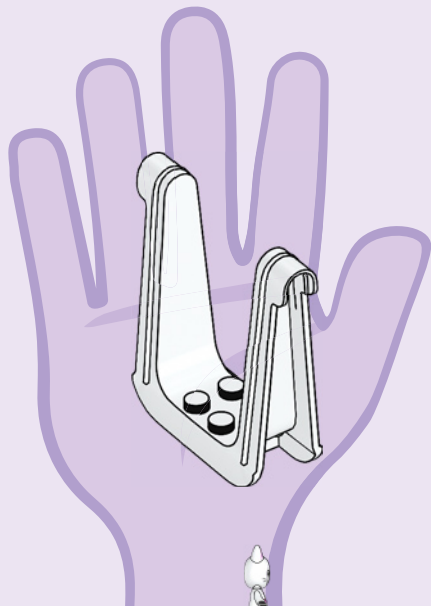
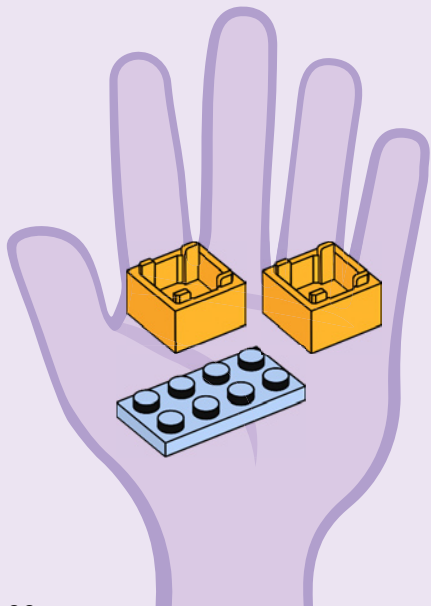

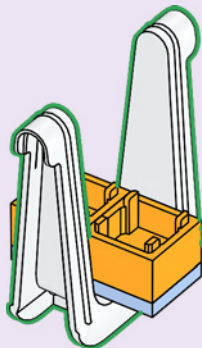
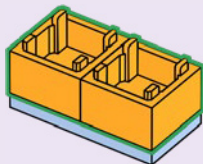
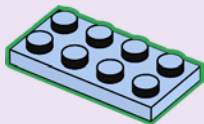

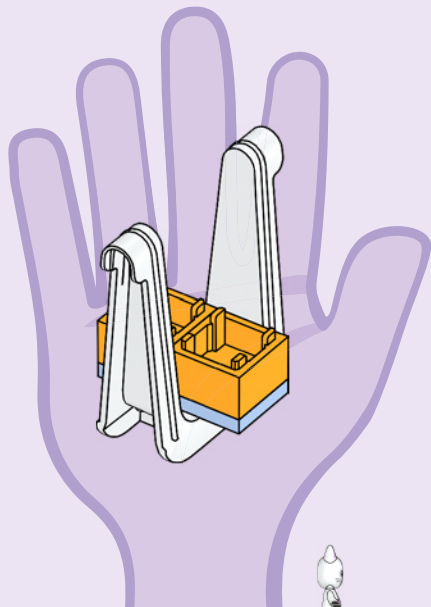

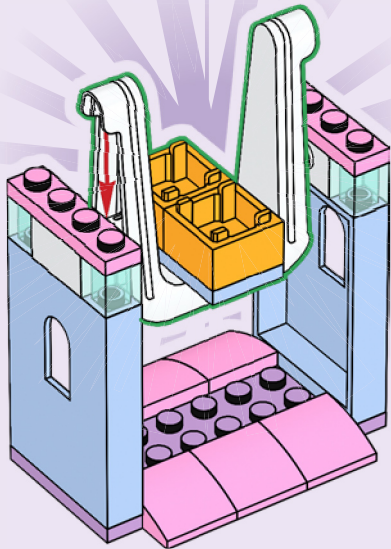



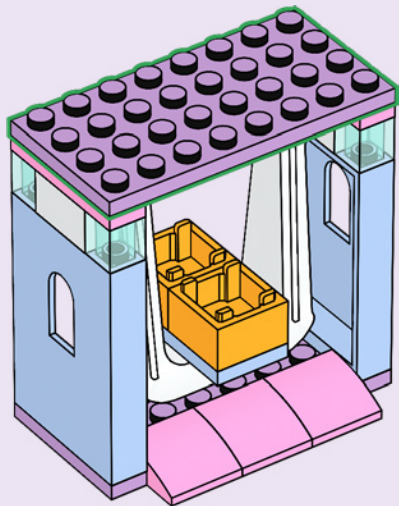

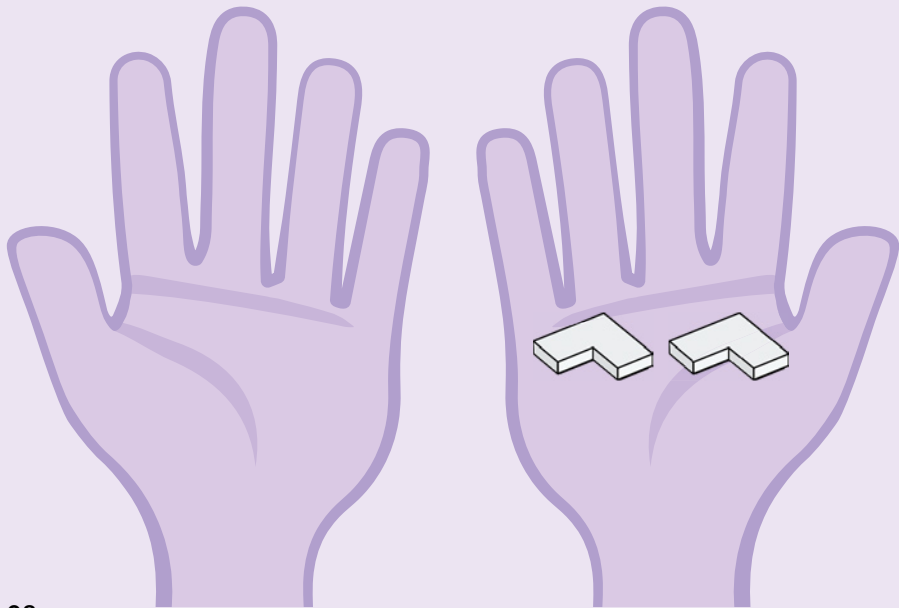

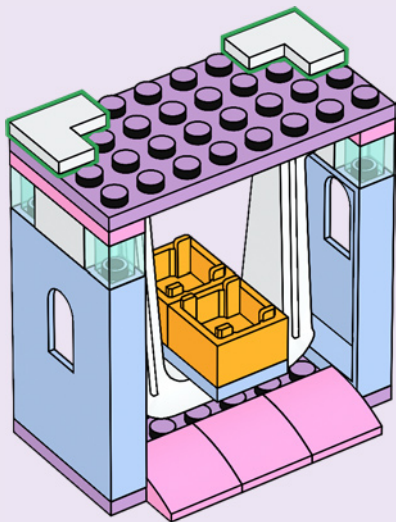

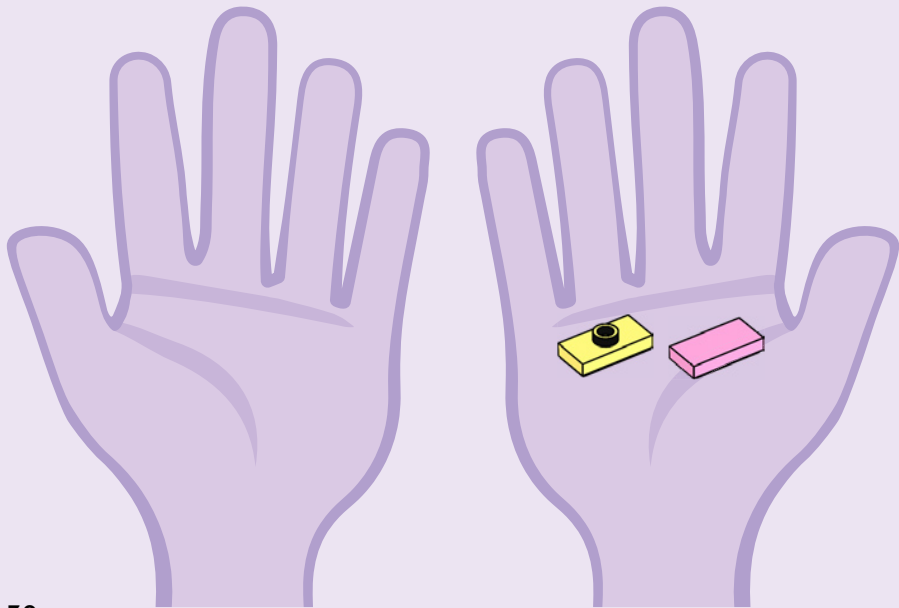

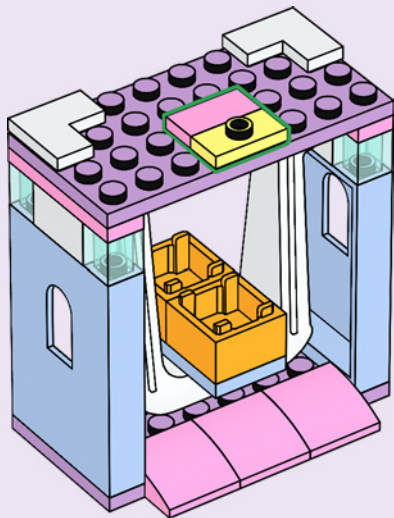

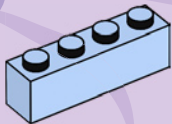
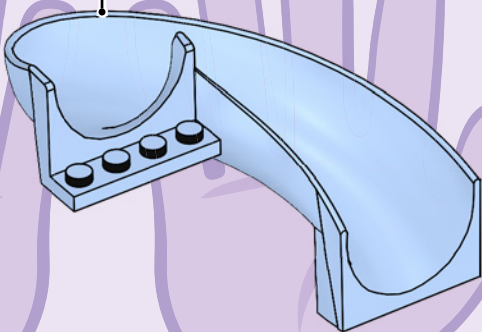
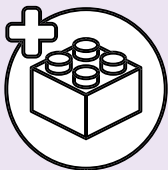

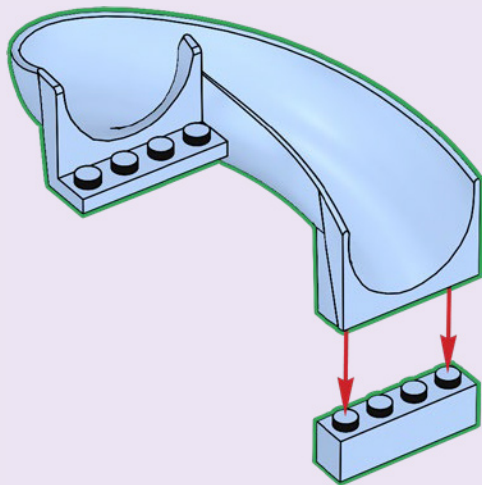

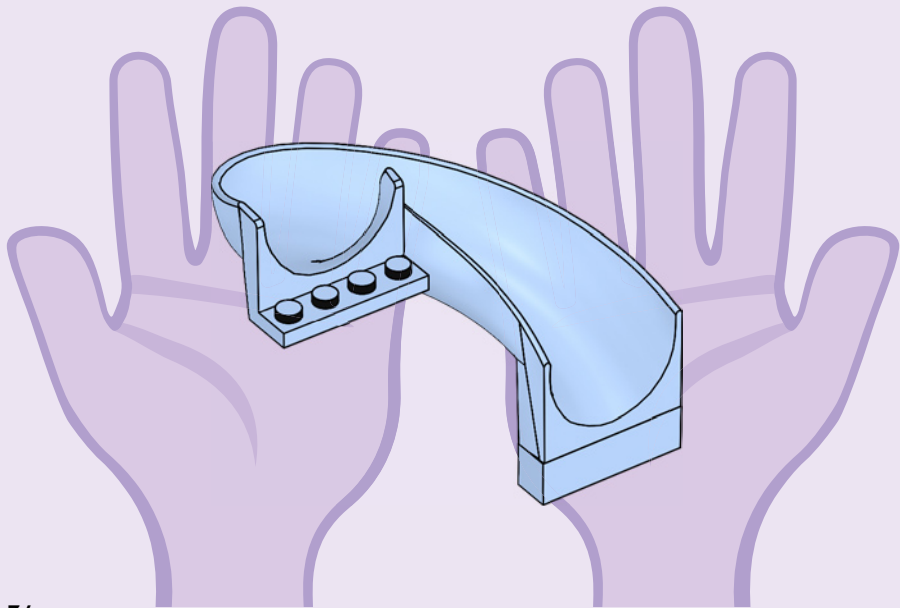

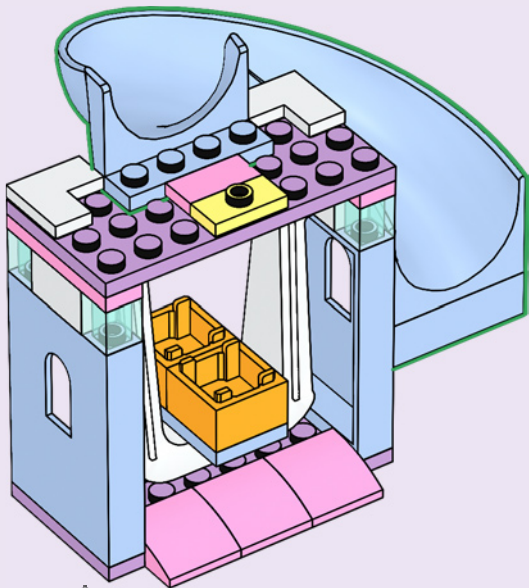

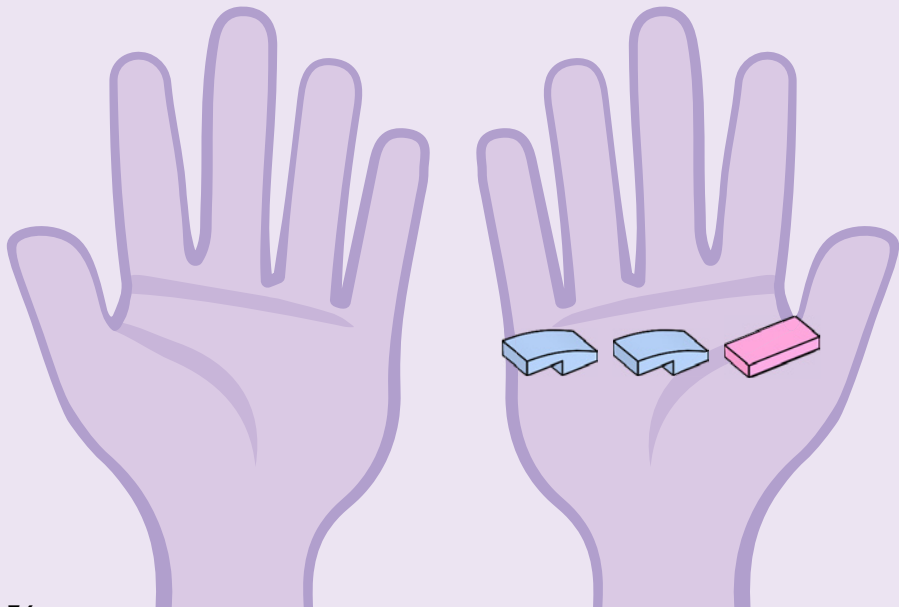

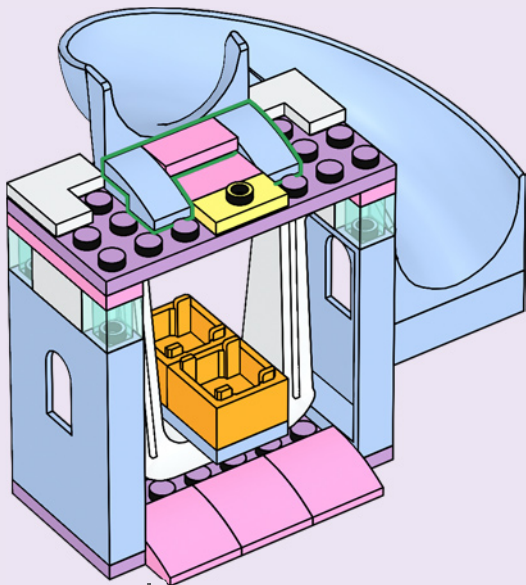

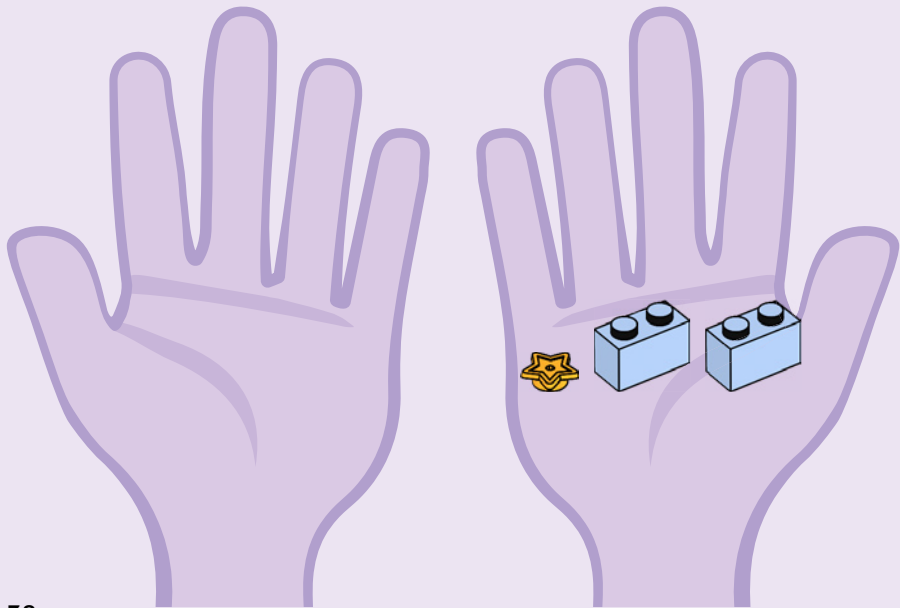

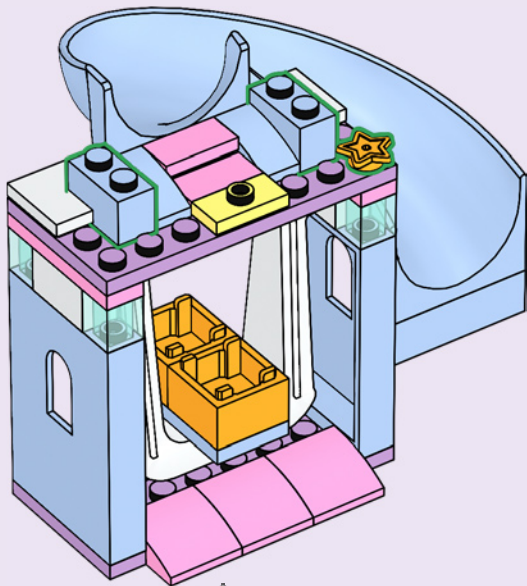

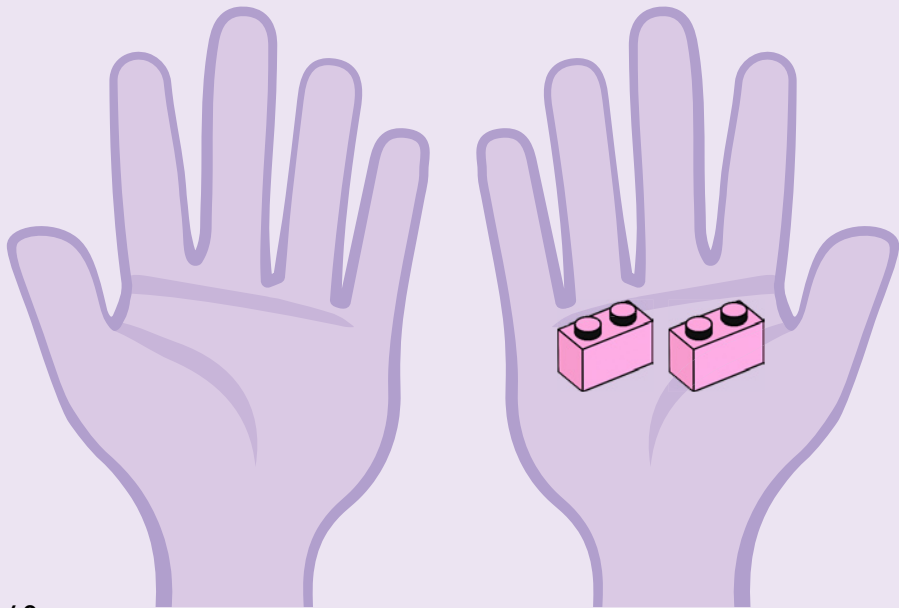

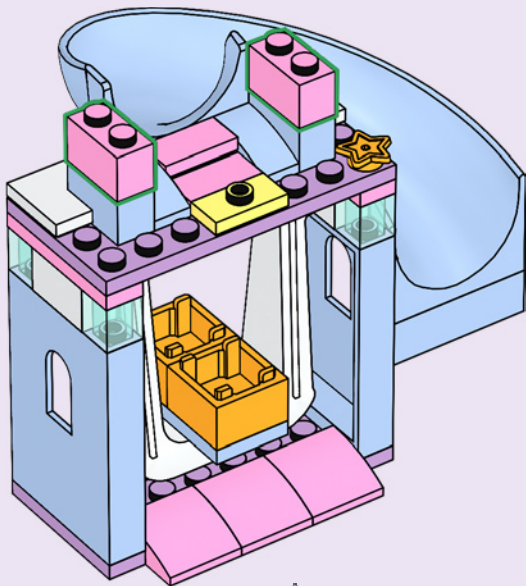

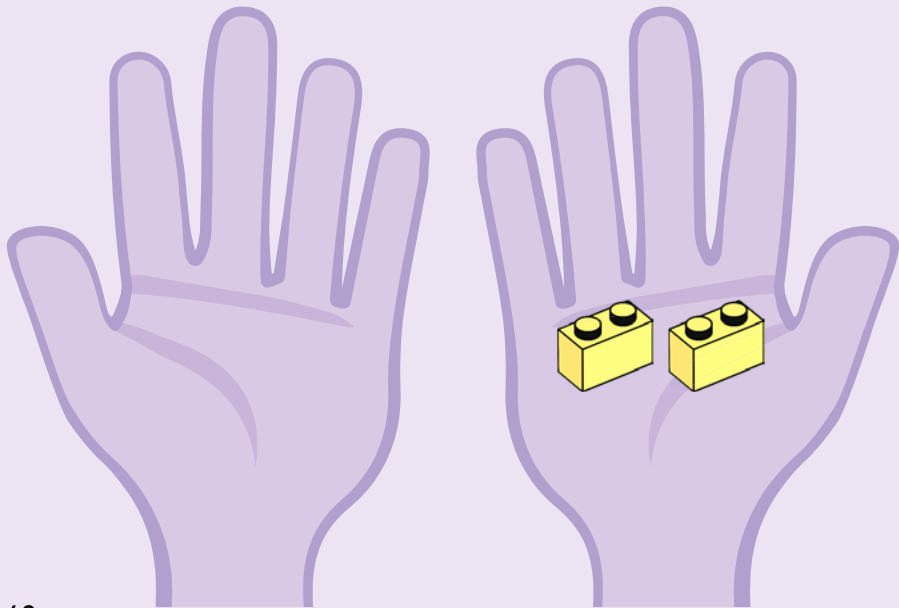

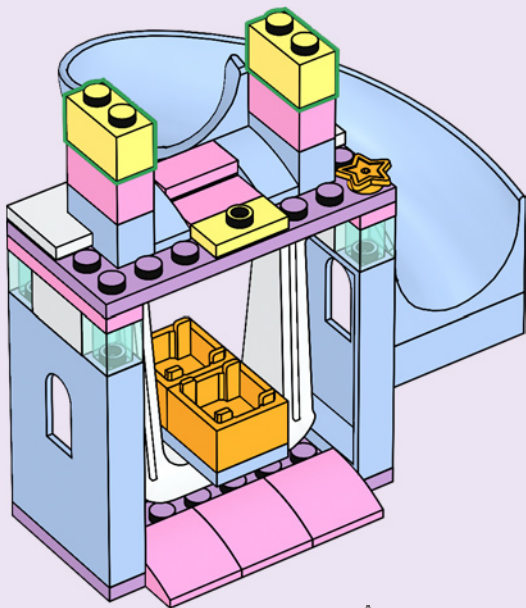

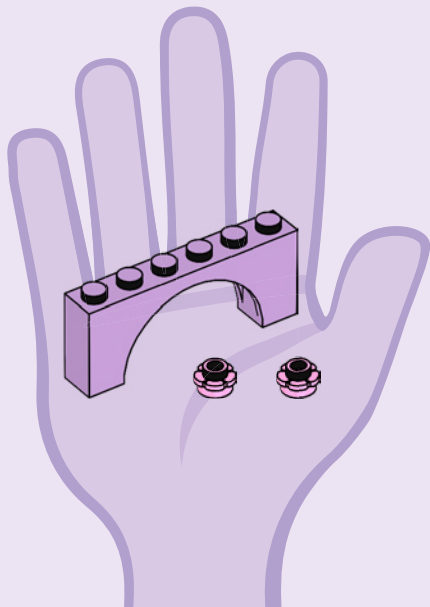

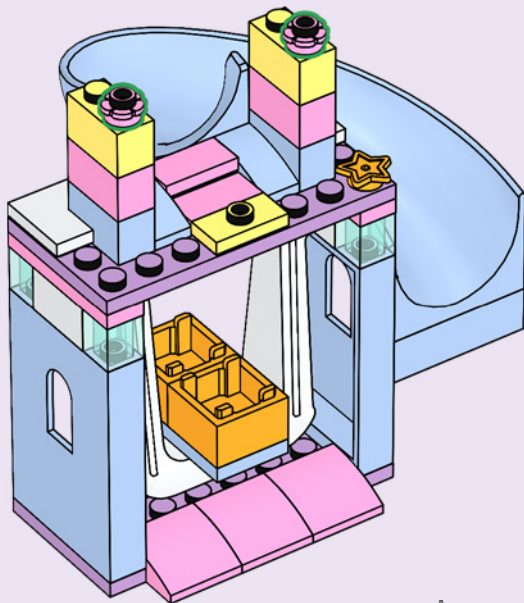

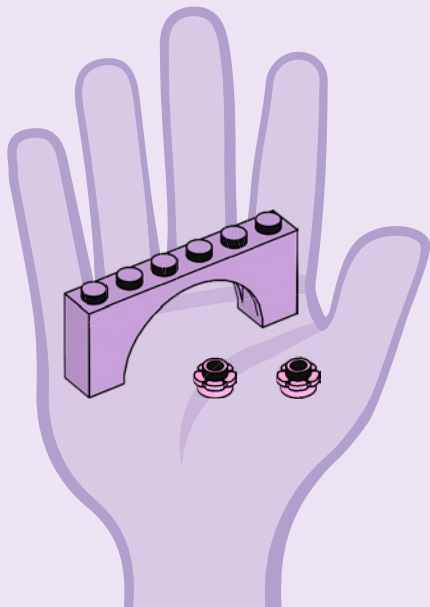

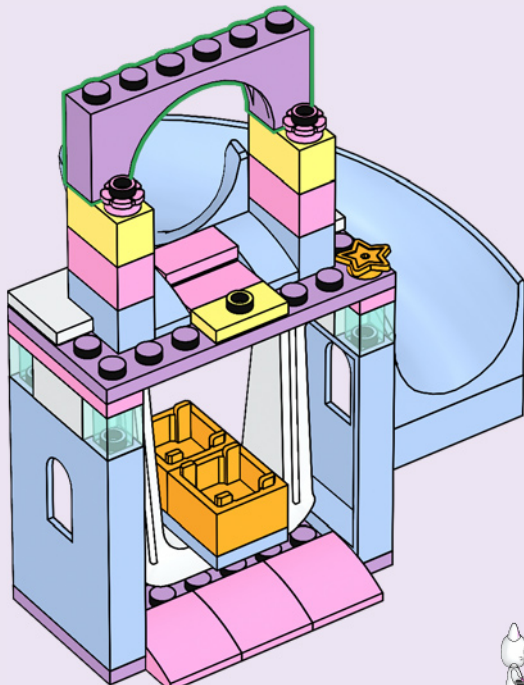

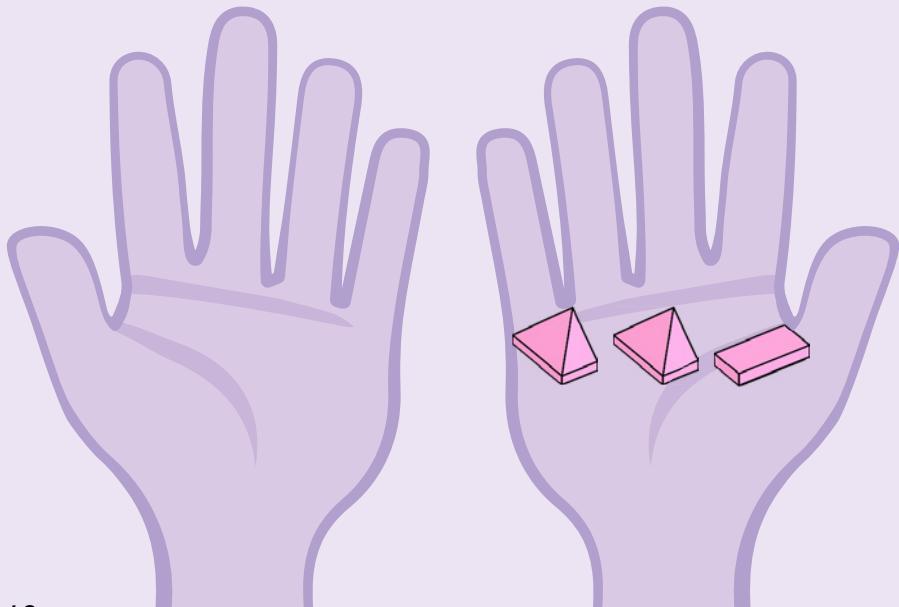









LEGO and the LEGO logo are trademarks of the LEGO Group.
©2024 The LEGO Group. 6519681
DreamWorks Gabby's Dollhouse © DreamWorks Animation LLC.
All rights reserved.

