



SONIC™

THE HEDGEHOG

76998



Q LEGO® Builder



LEGO.com/sustainable-packaging



FR
DONNEZ
OU
RECYCLEZ



OU



OU



ASSOCIATION

MAGASIN

DÉCHÈTERIE

Adresses sur quefairedemesdechets.fr

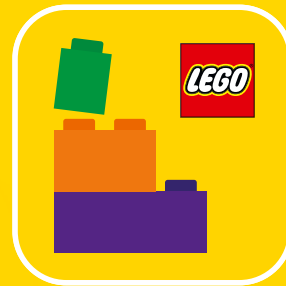

BUILDER



Apple and the Apple logo are trademarks of Apple Inc., registered in the U.S. and other countries and regions. App Store is a service mark of Apple Inc. Google Play and the Google Play logo are trademarks of Google LLC. Tencent and the Tencent logo are trademarks of Tencent Inc.

[LEGO.com/devicecheck](https://www.lego.com/devicecheck)

EN Ask parents' permission before going online | **DE** Eltern um Erlaubnis bitten, bevor du online gehst | **FR** Demande l'autorisation d'un parent avant d'aller en ligne | **IT** Chiedi il permesso ai tuoi genitori prima di andare online | **ES** Pídeles permiso a tus papás antes de conectarte a Internet | **PT** Pede autorização aos pais antes de acederes online | **ZH** 上网前应先征得父母的同意 | **PL** Poproś rodziców o zgodę, zanim wejdiesz do Internetu | **CS** Než půjdeš na internet, požádej rodiče o svolení | **SK** Skôr než pôjdeš na internet, vypýtaj si povolenie od rodičov | **HU** Kérj szülői engedélyt, mielőtt online csatlakoznál! | **RO** Cere permisiunea părinților înainte de a te conecta online | **BG** Поискайте разрешение от родител, преди да влезете онлайн | **LV** Pirms došanās tiešsaistē palūdz atļauju vecākiem | **ET** Enne Interneti kasutamist küsi vanematelt luba | **LT** Prieš prisijungdami prie interneto, atsklauskite tėvų



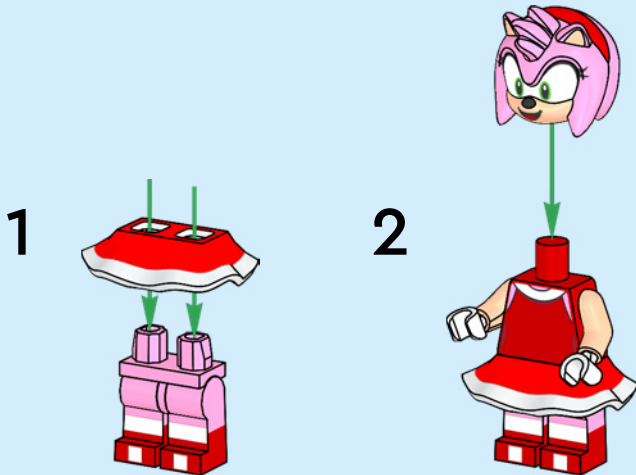
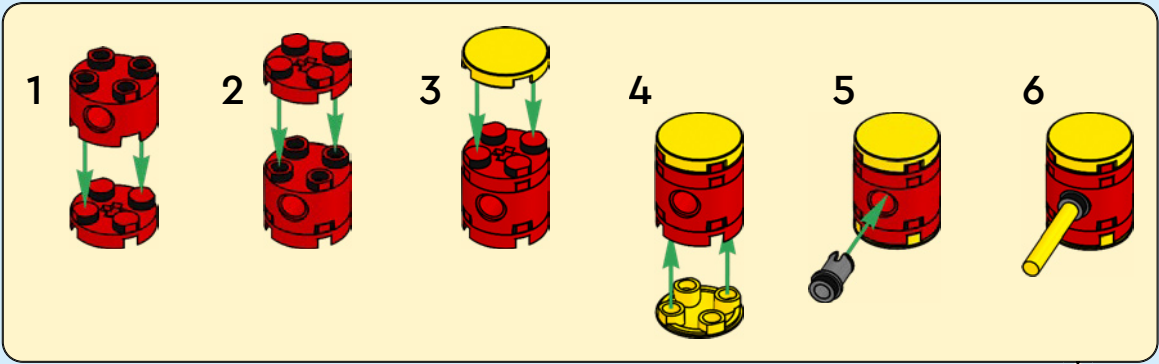

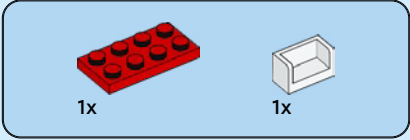
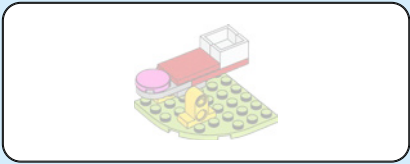

1

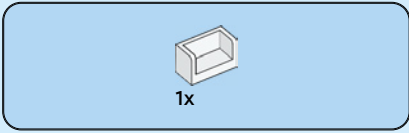
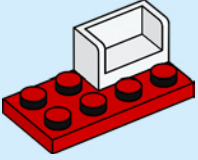

2

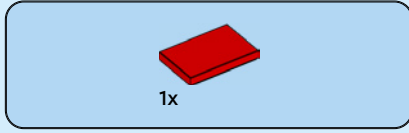
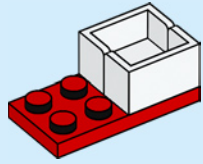

3

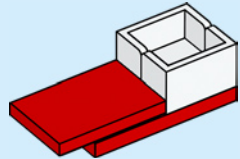

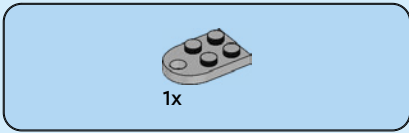

4

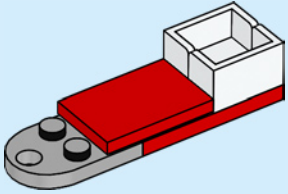

5

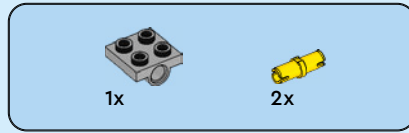
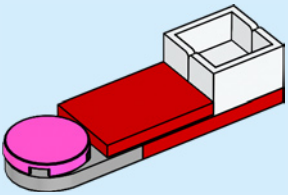

6

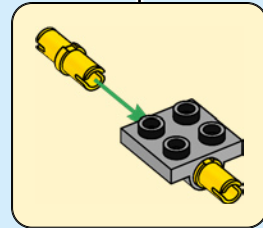
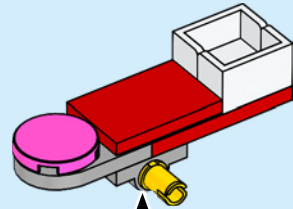



2x

7

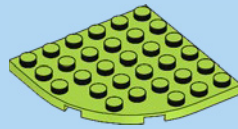
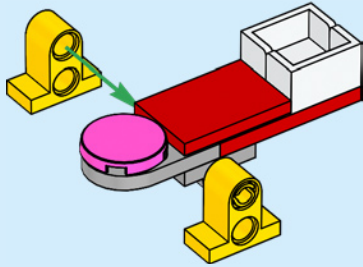

1x

8





9

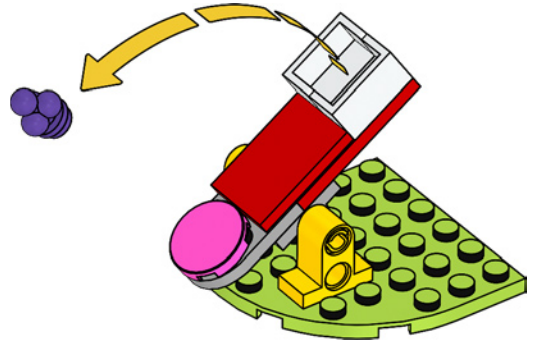
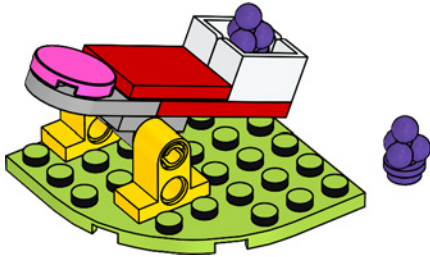



1

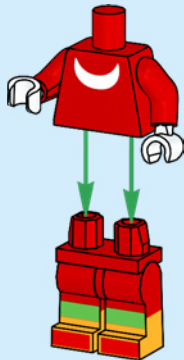

2

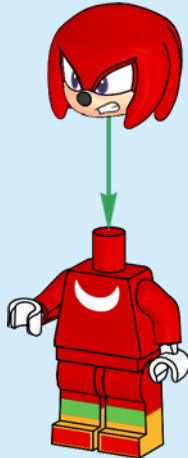

3



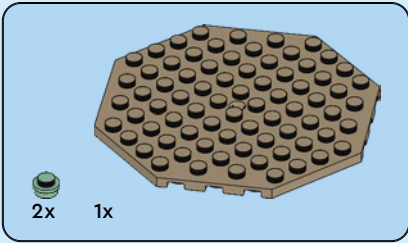
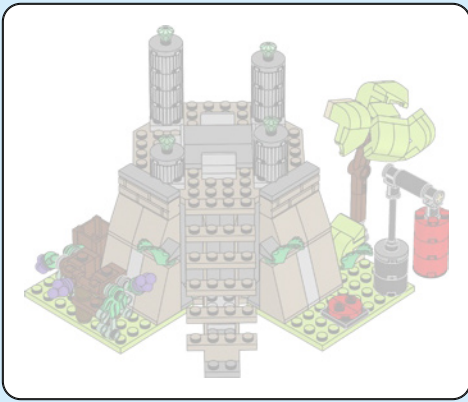

1

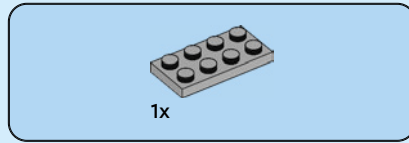
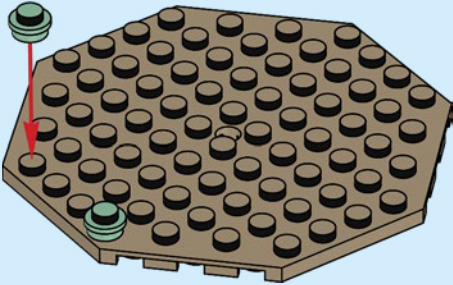

2

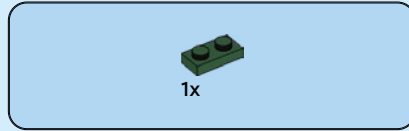
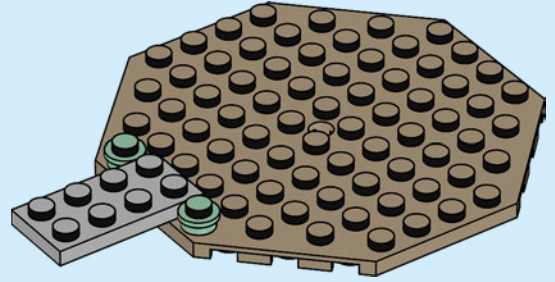

3

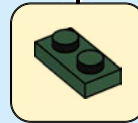
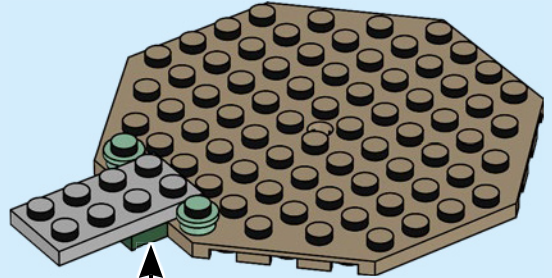

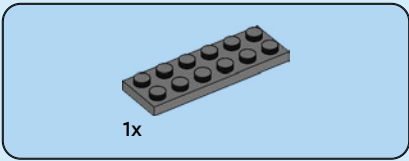

4

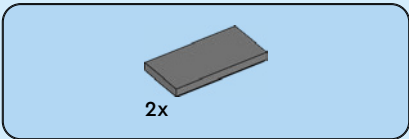
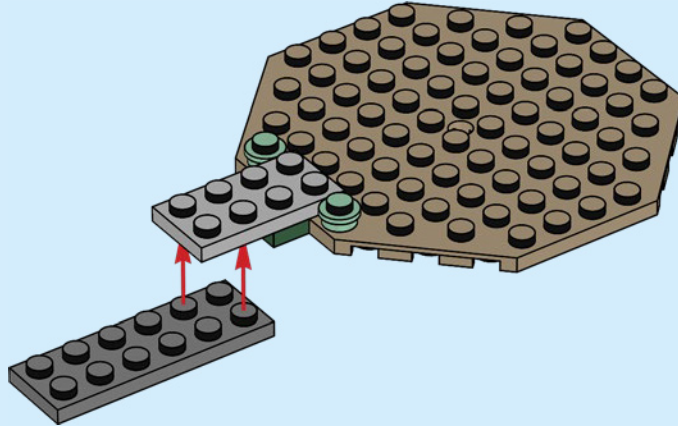

5

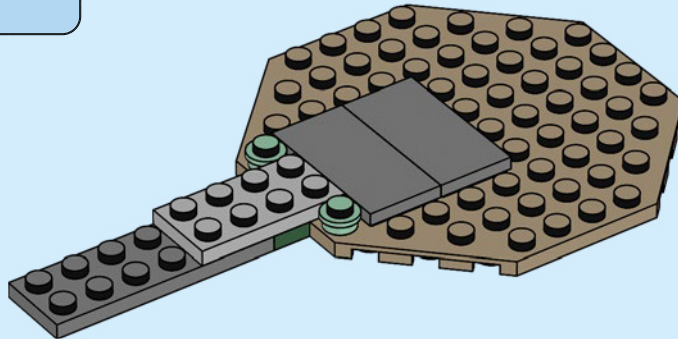

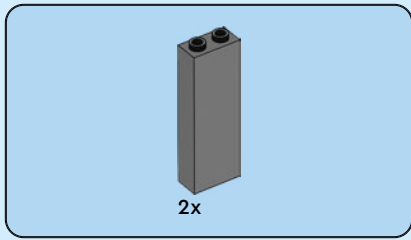

6

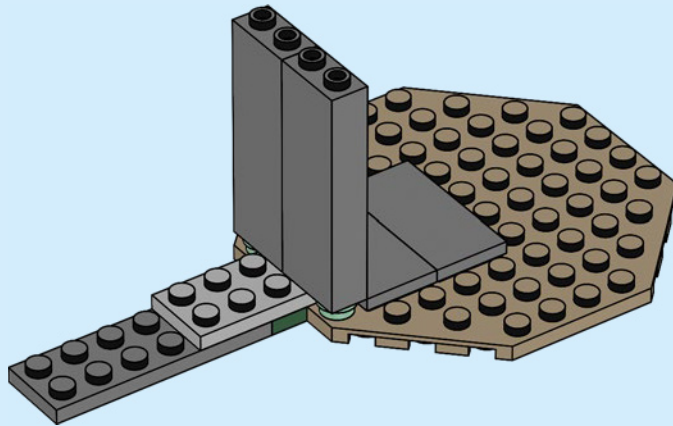

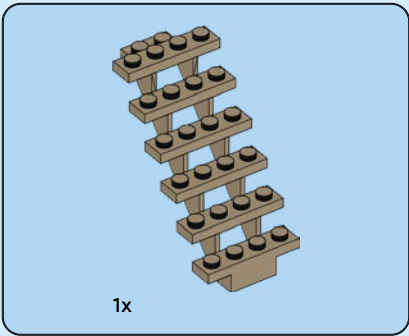

7

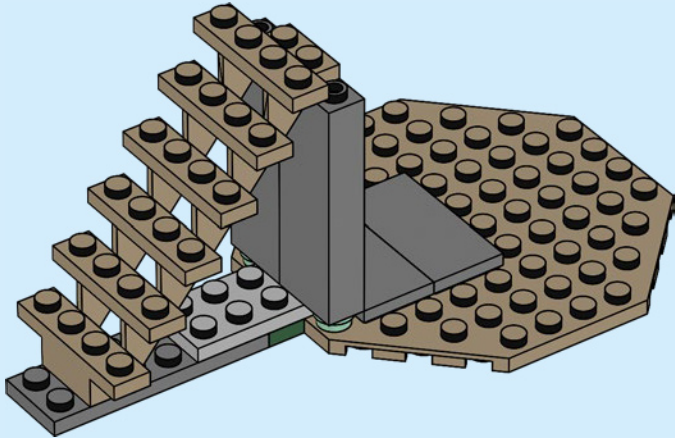



2x

8

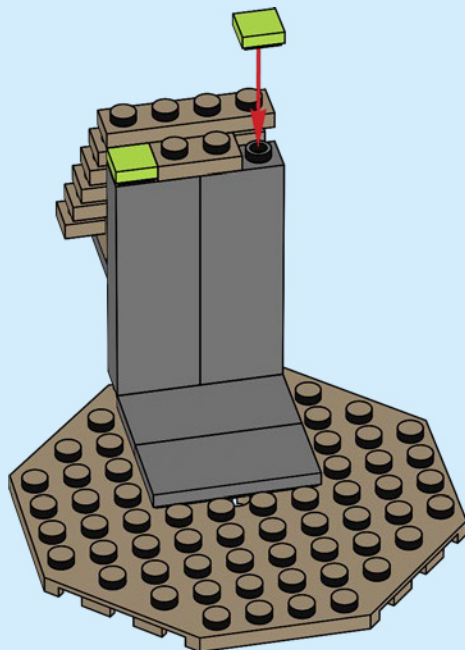
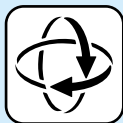

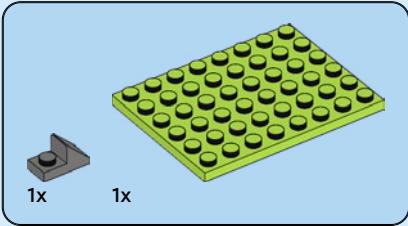
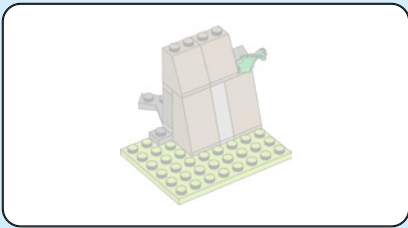

9

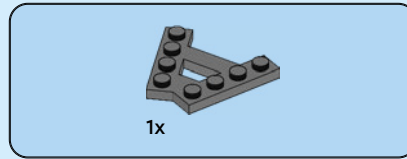
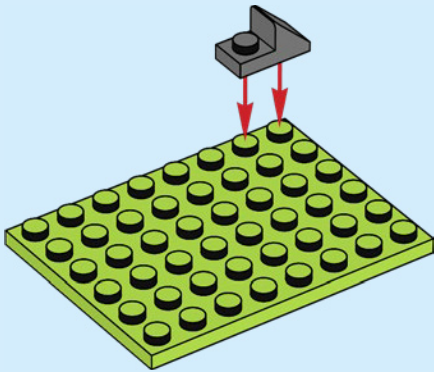

10

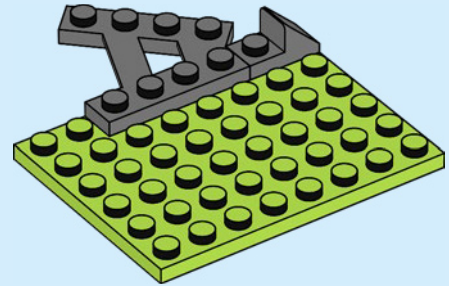

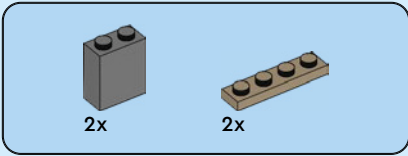

11

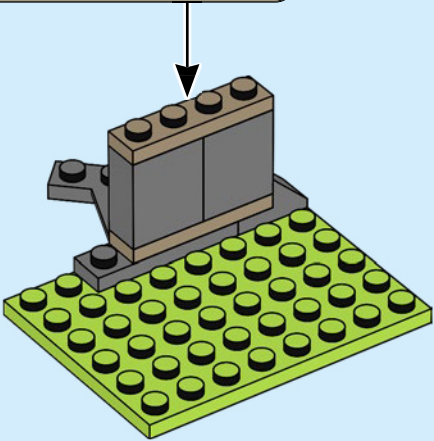
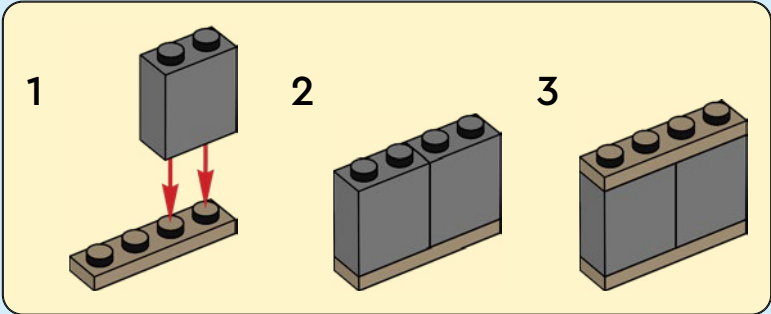

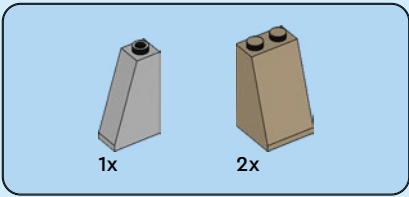

12

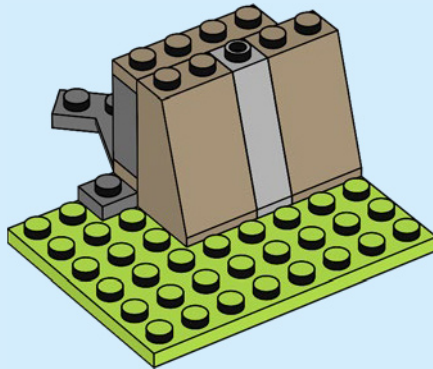

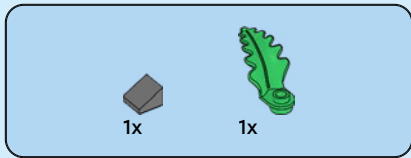

13

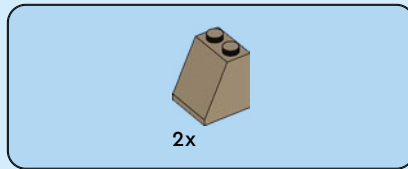
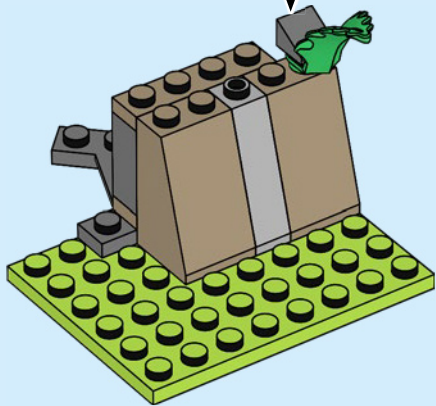
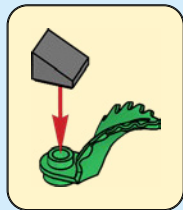

14

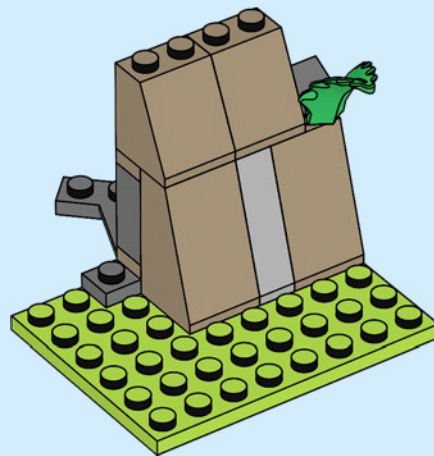

15

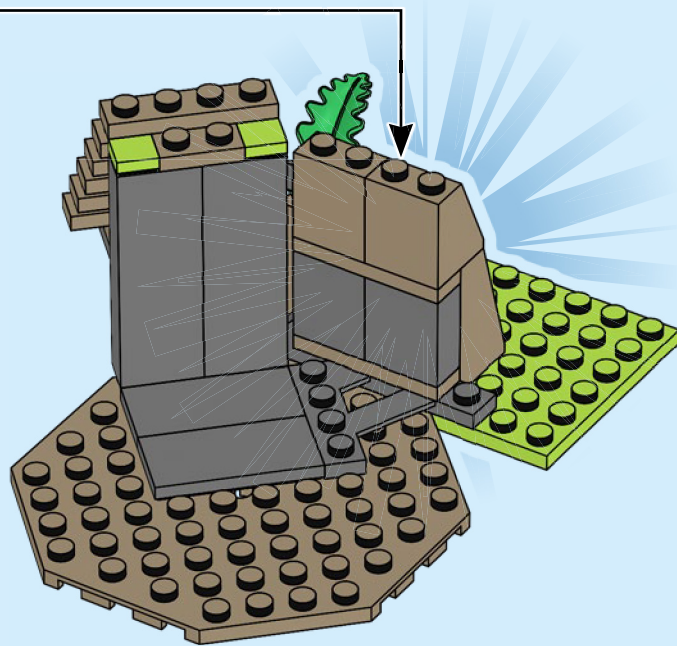

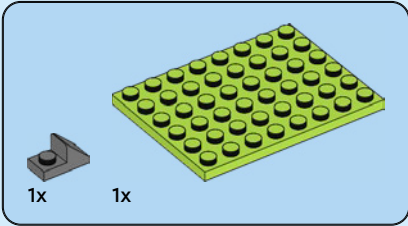
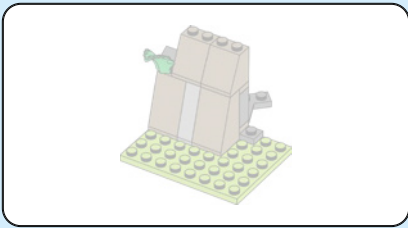

16

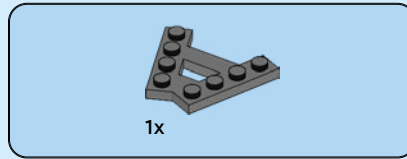
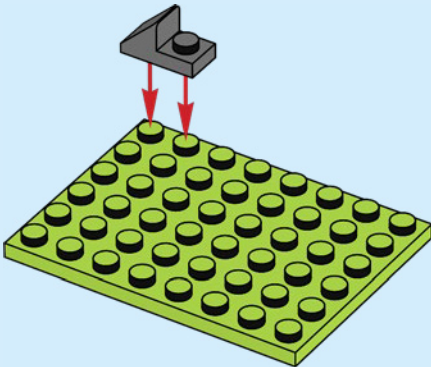

17

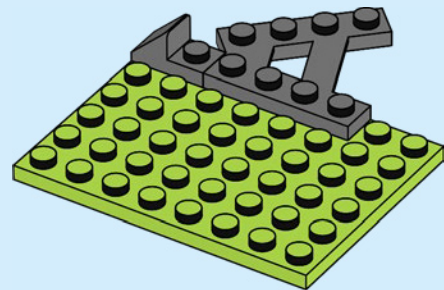

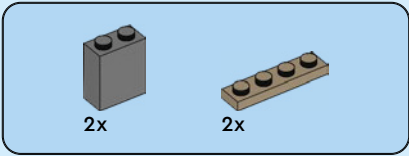

18

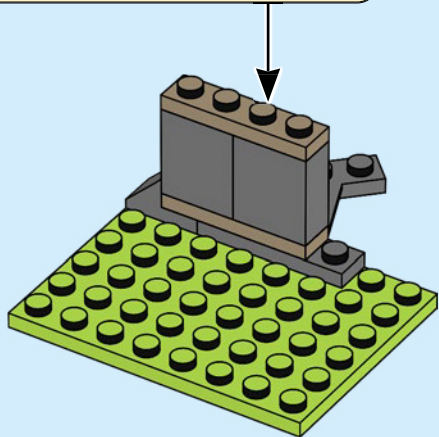
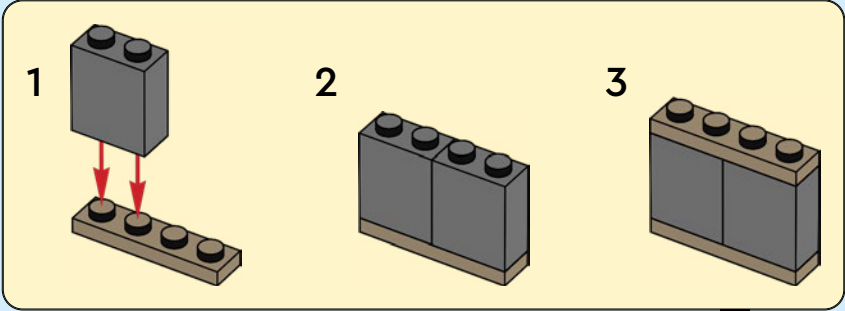

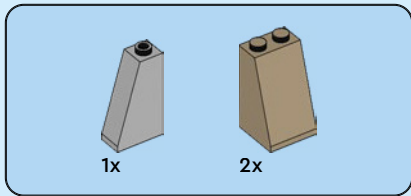

19

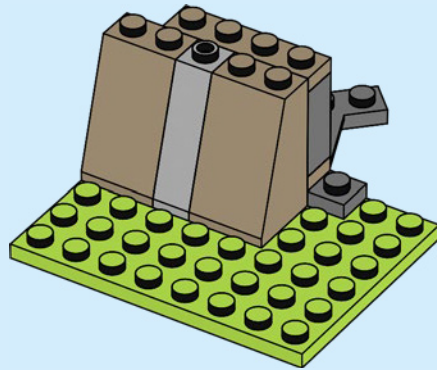

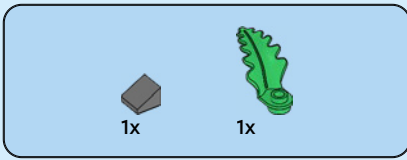

20

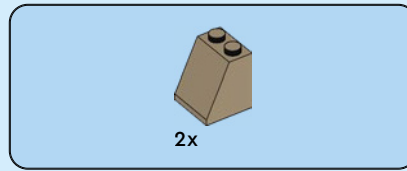
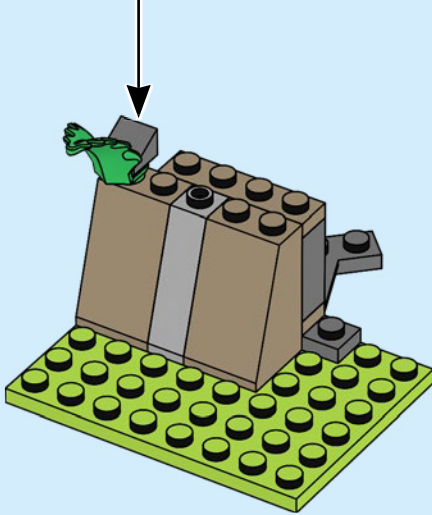
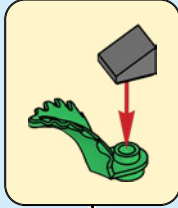

21

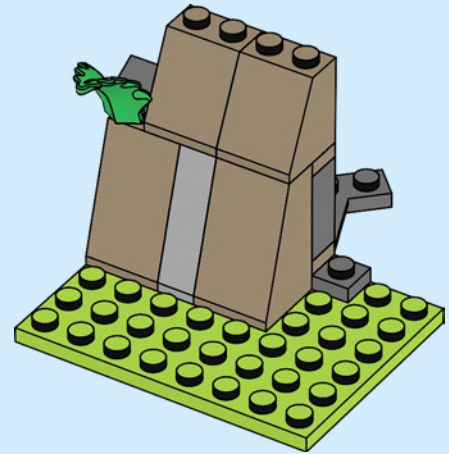

22

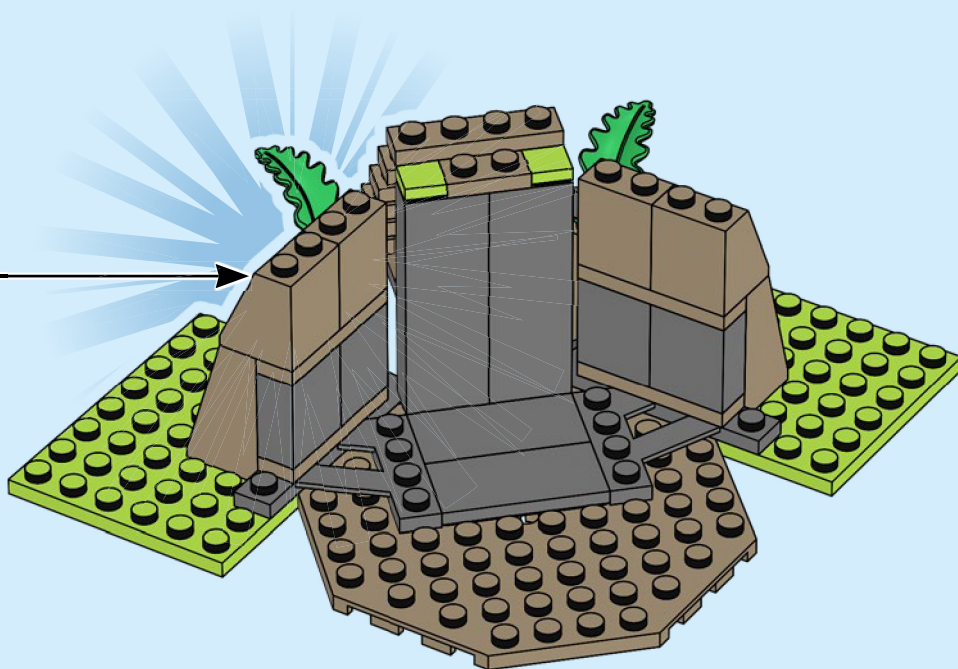

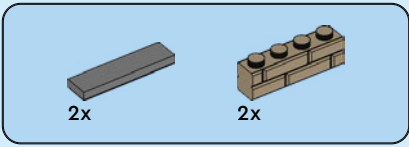

23

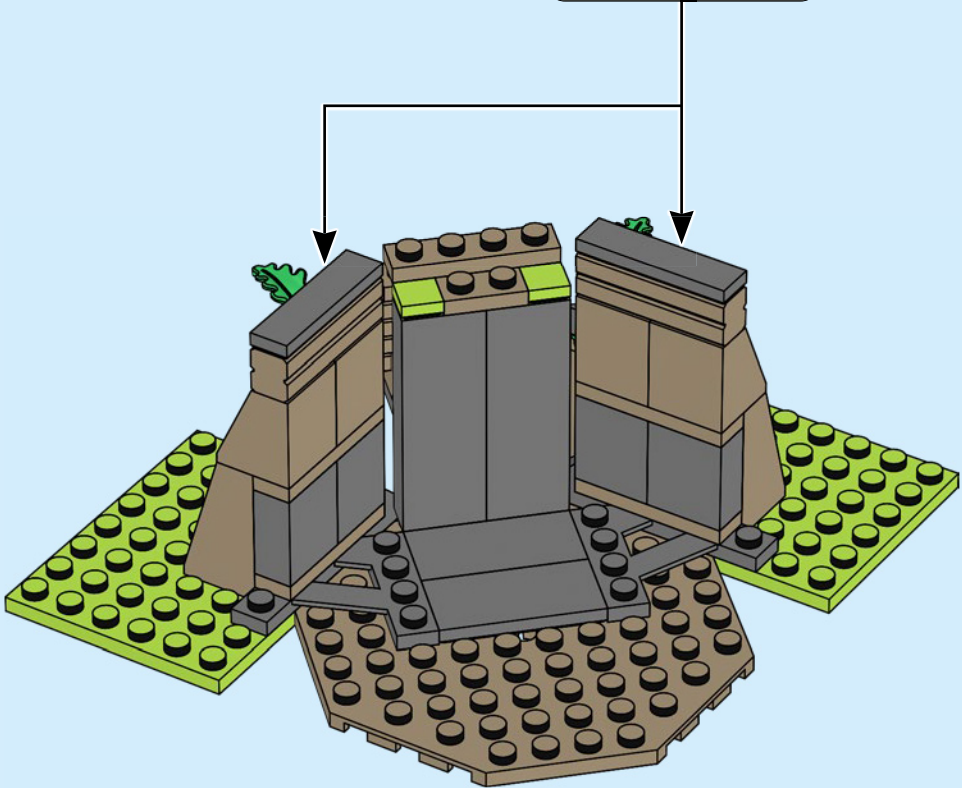
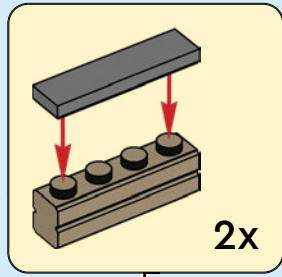

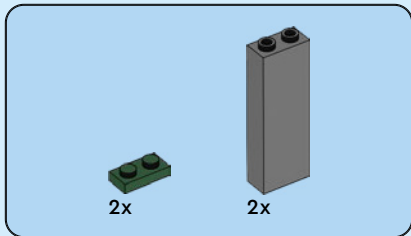

24

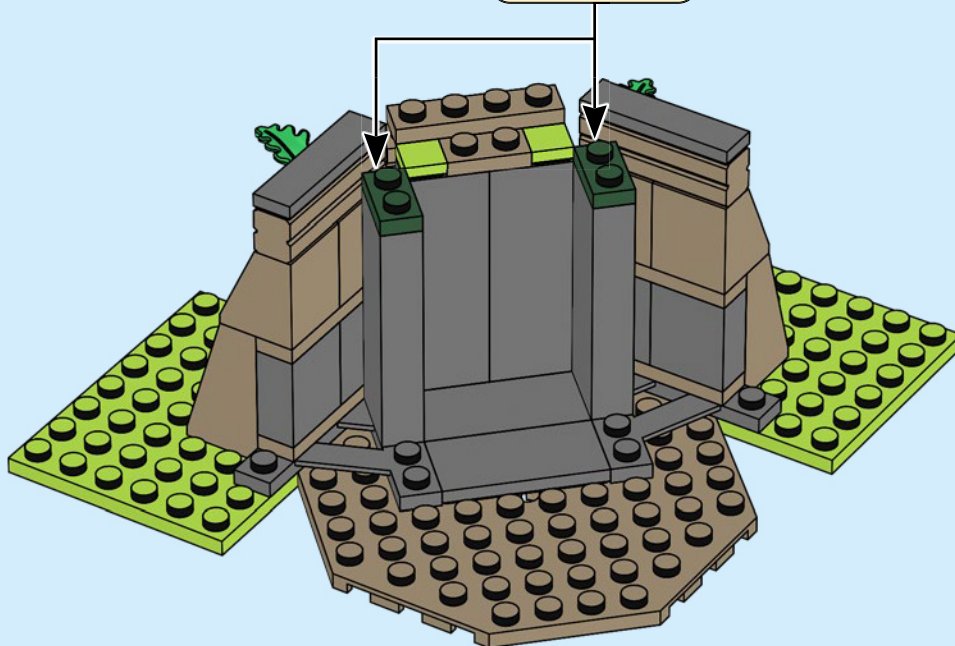
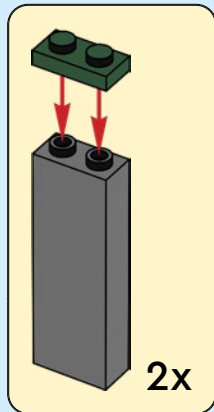



2x



2x

25

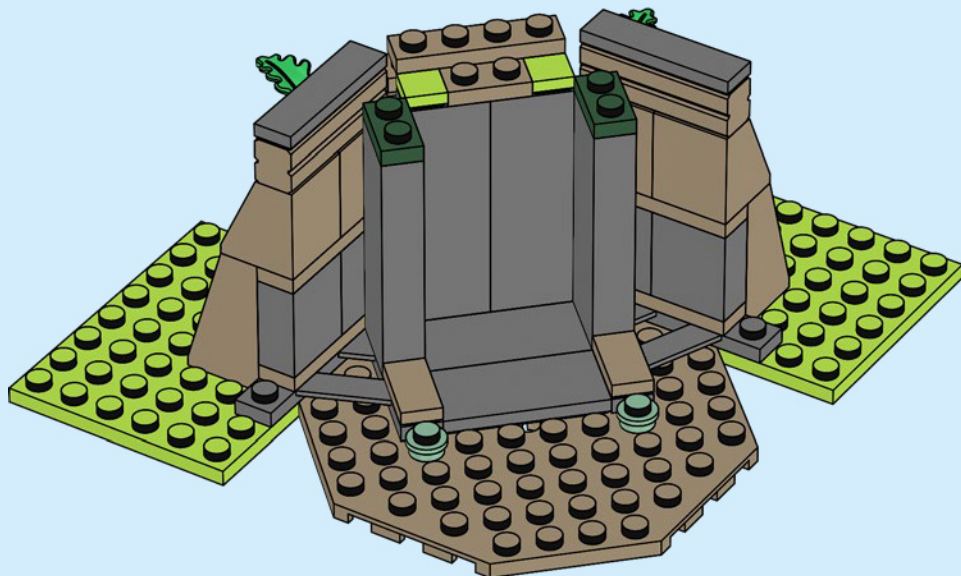



2x

26

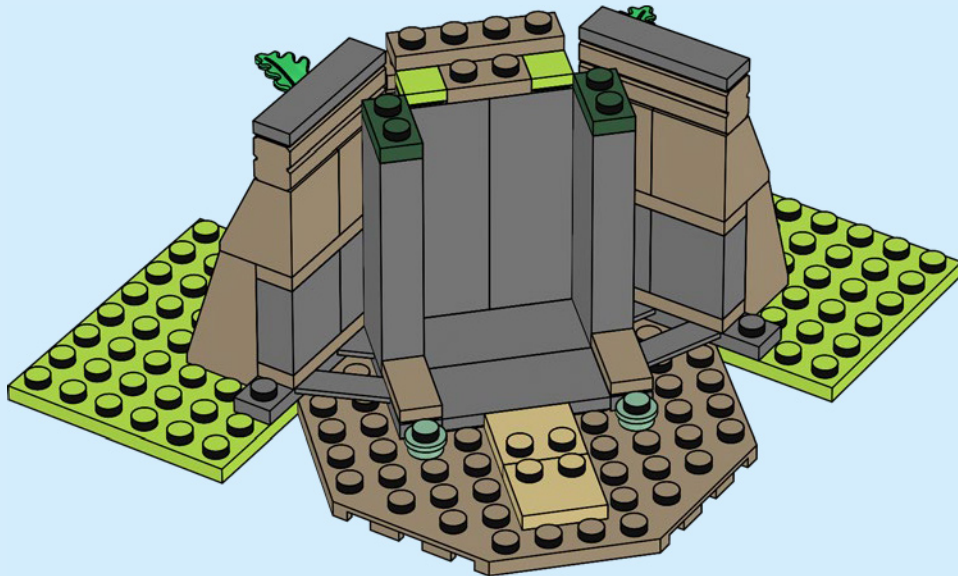

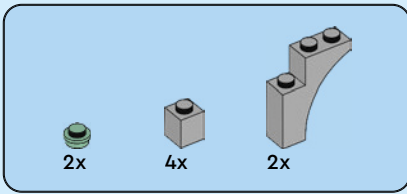

27

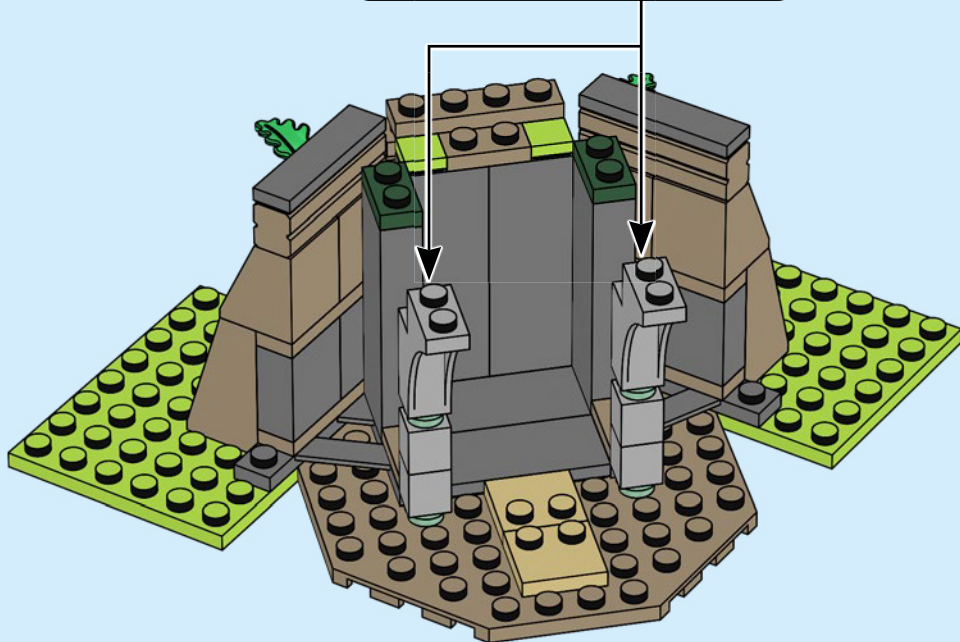
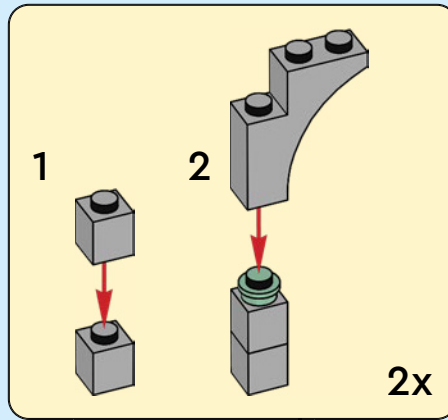

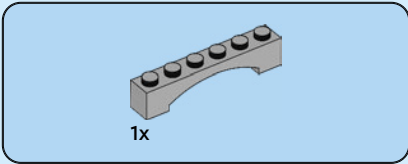

28

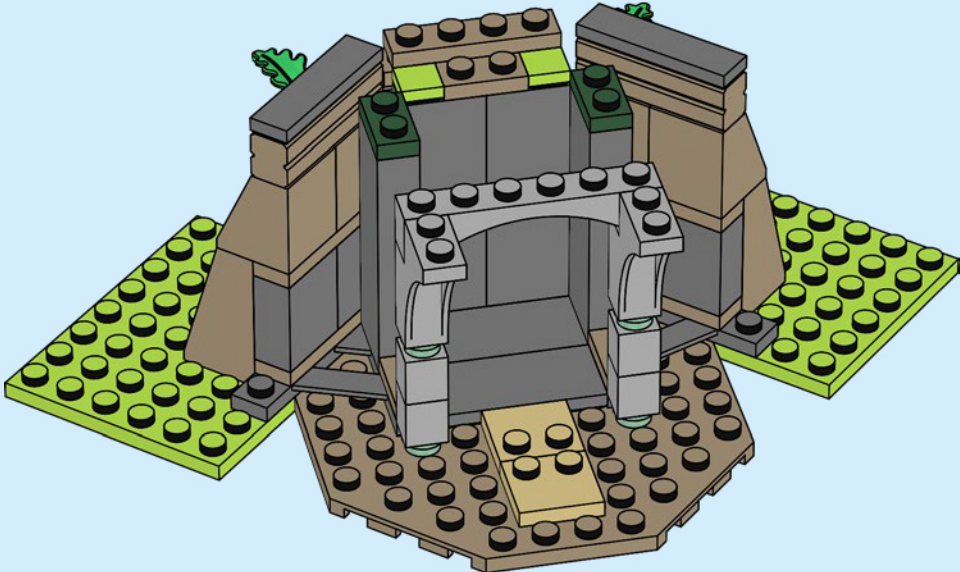

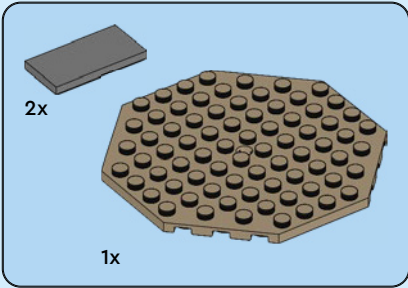
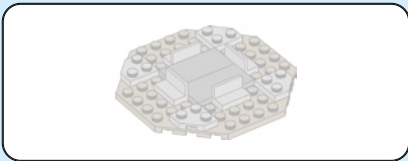

29

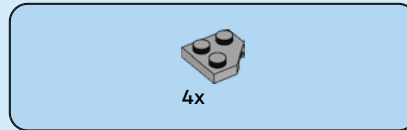
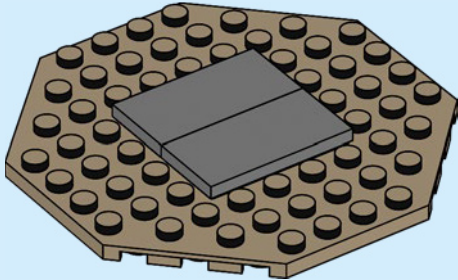

30

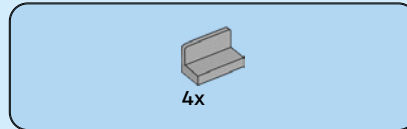
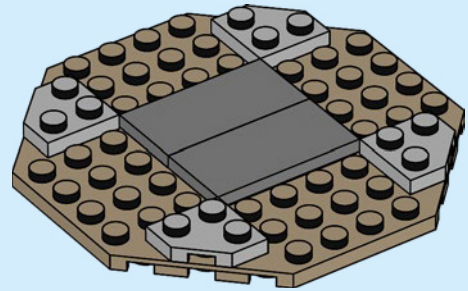

31

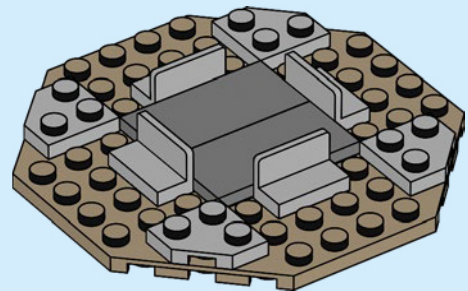

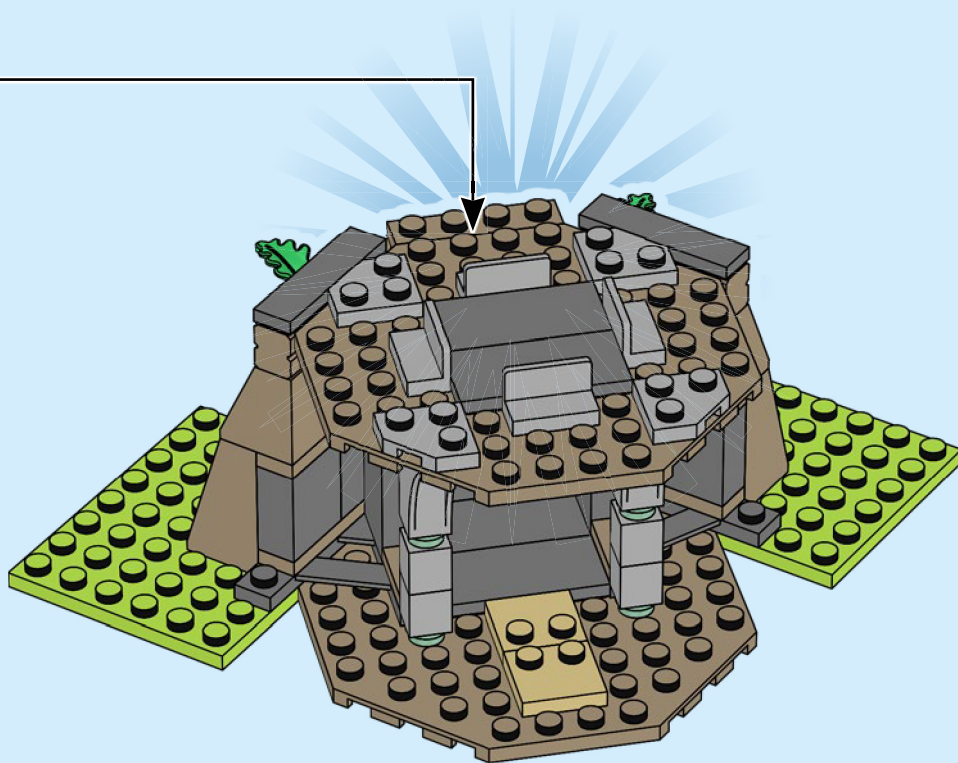

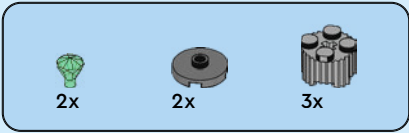

33

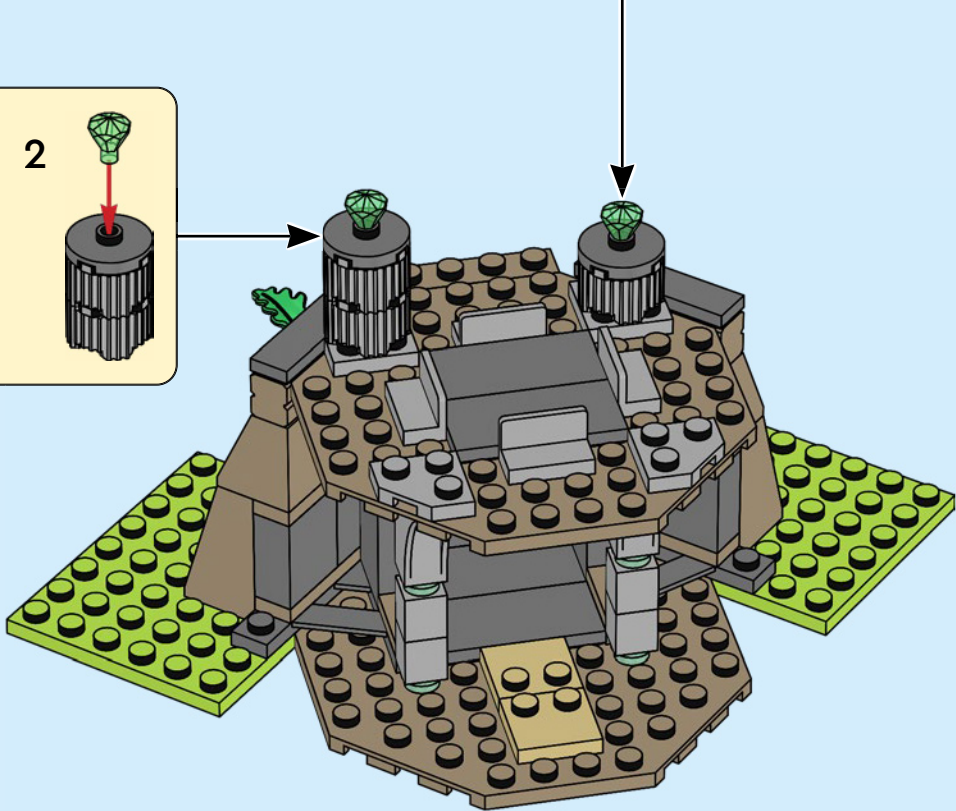
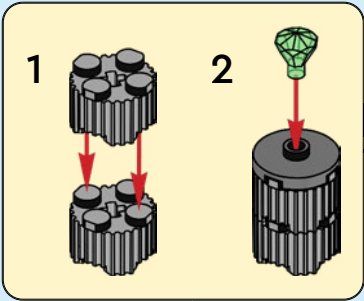
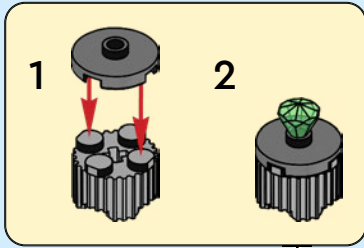

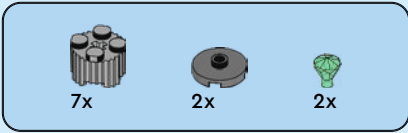

34

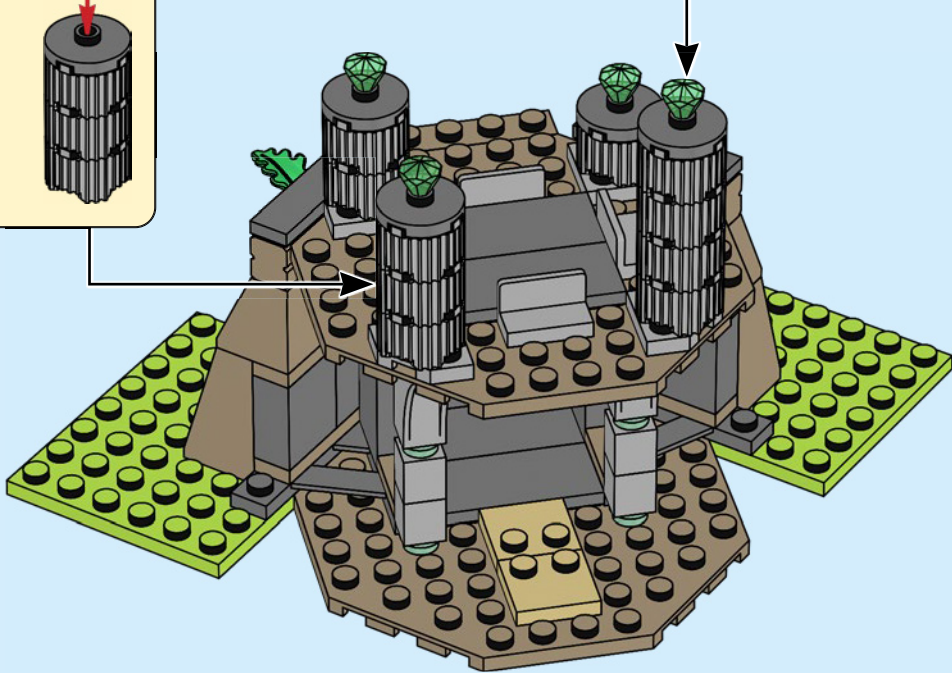
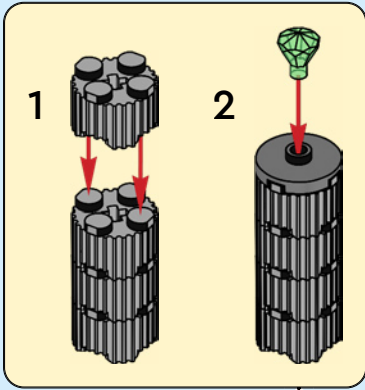
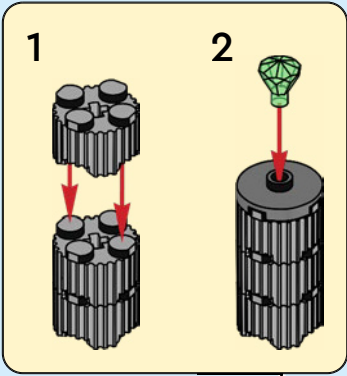

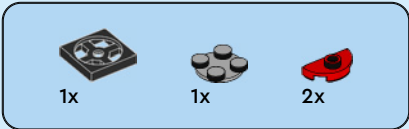

35

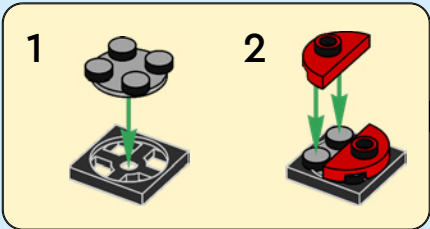
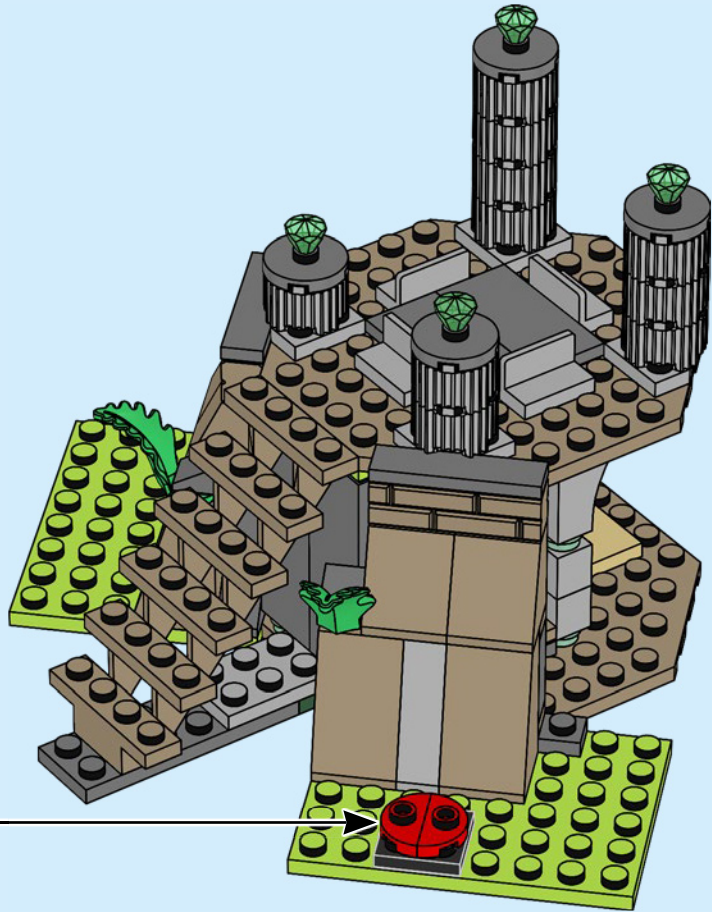

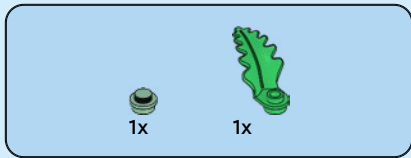

36

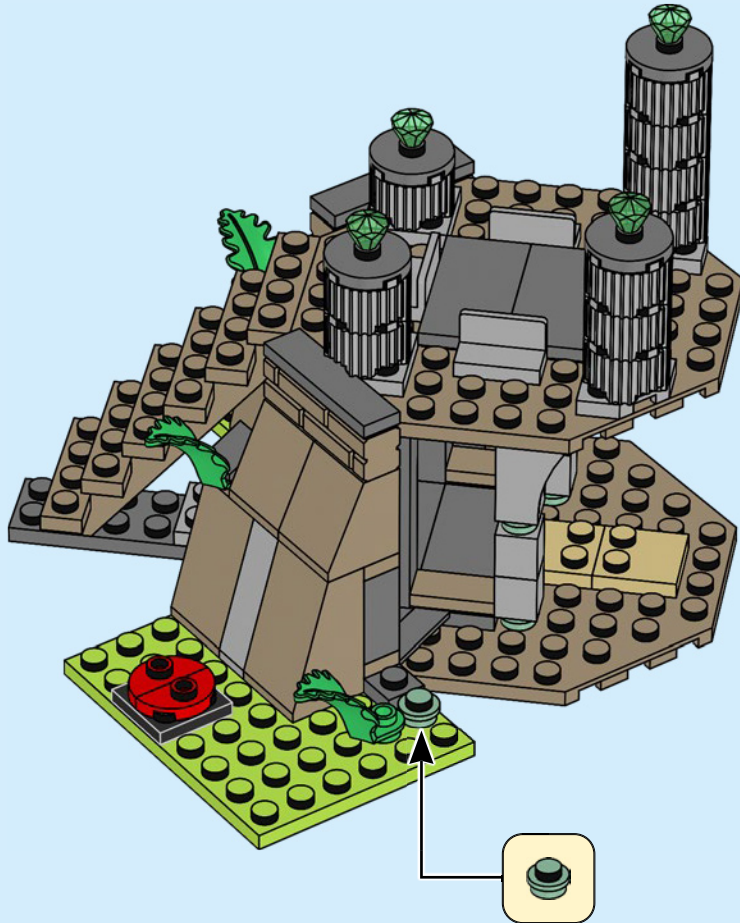



1x

37

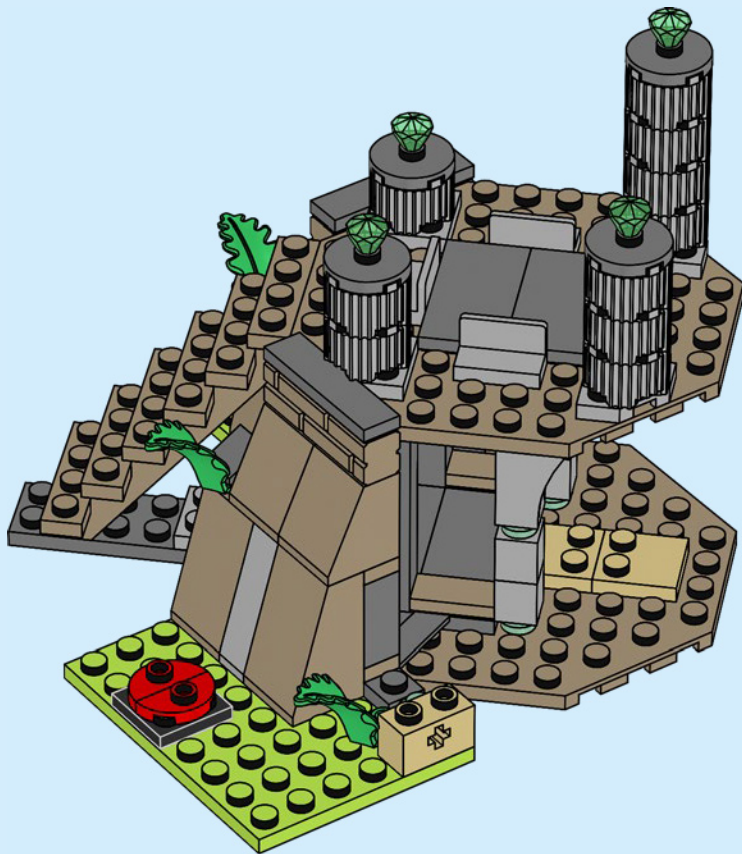



2x

38

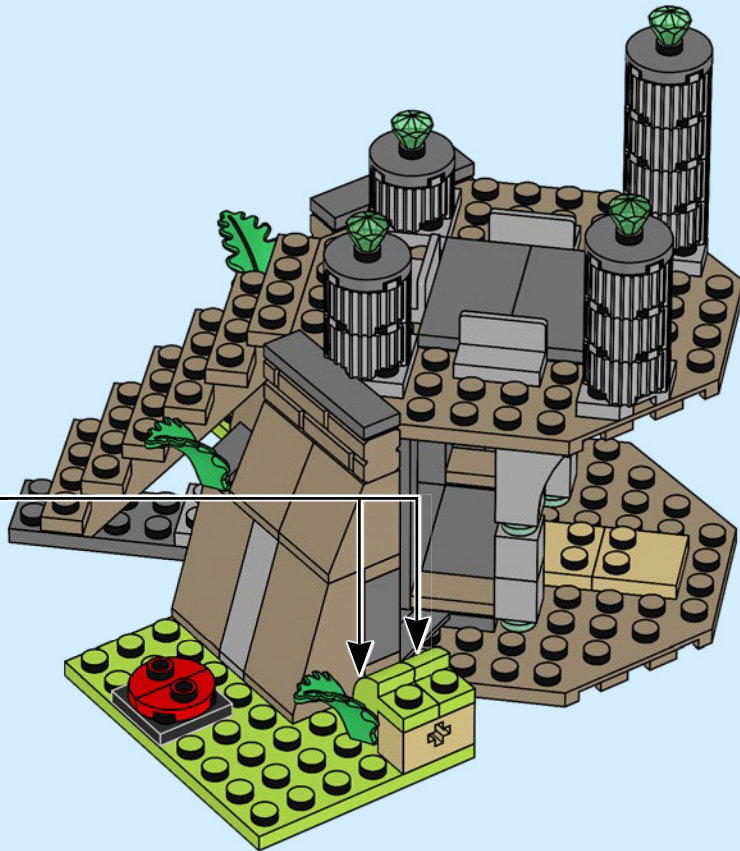

2x





1x

39

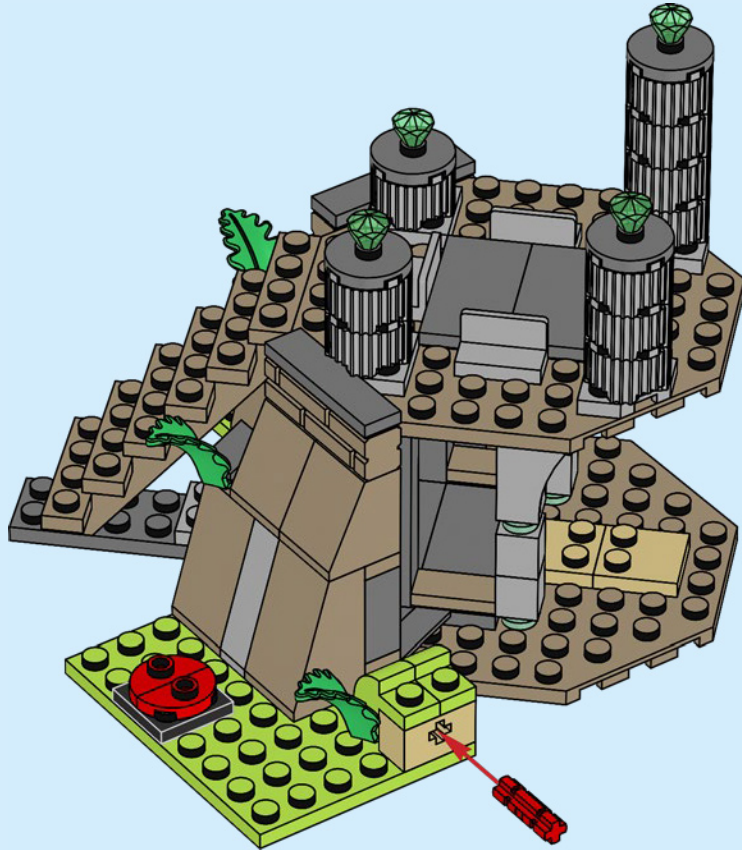



1x



1x

40

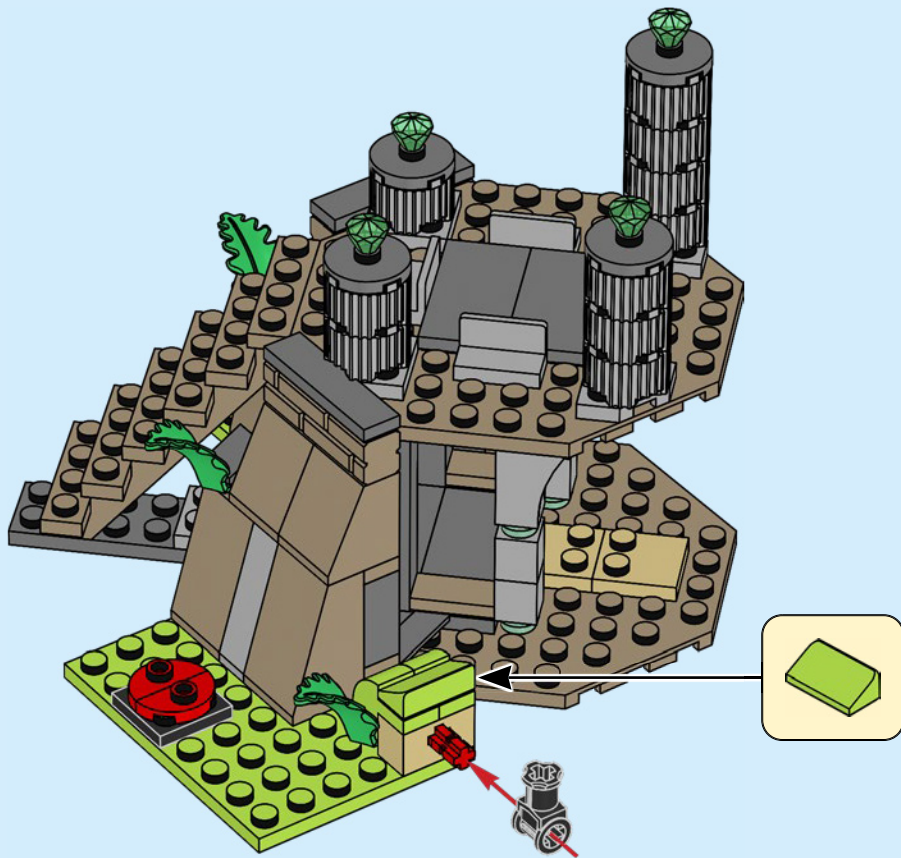

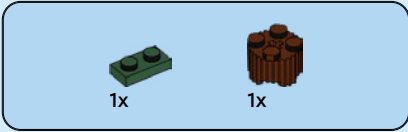

41



42

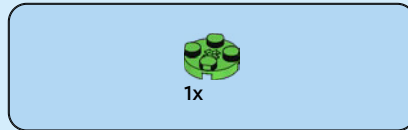

43

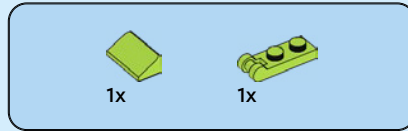
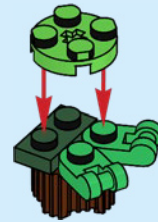

44

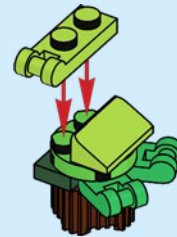



2x

45

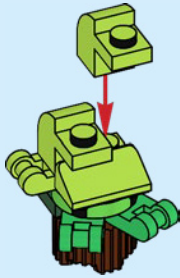

1x

46



2x



4x



2x

47

1

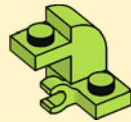

2

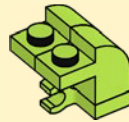

3

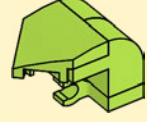

2x

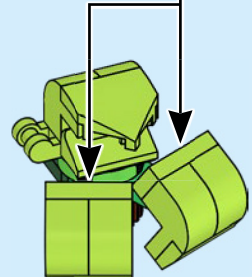

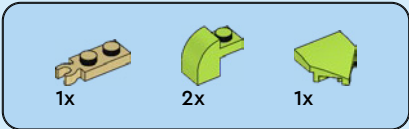

48

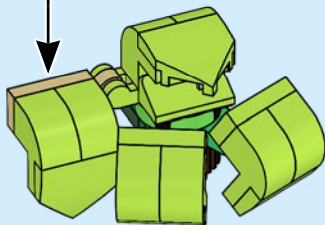
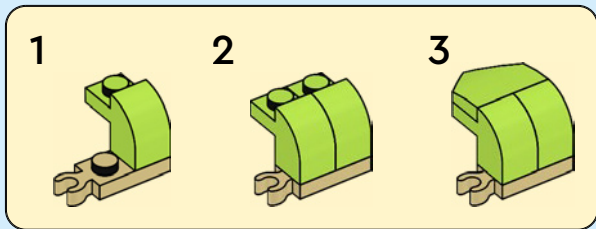

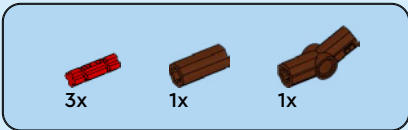

49

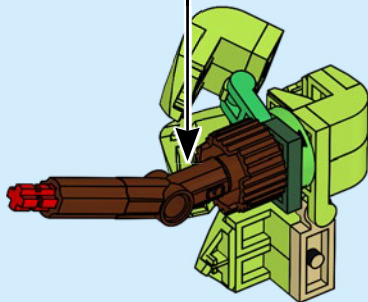
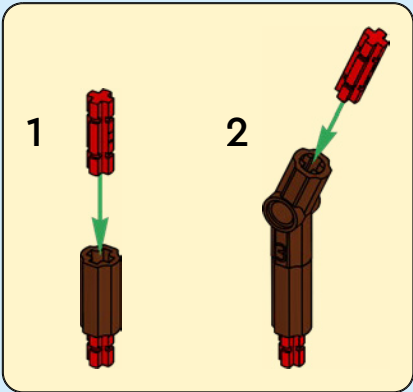

50

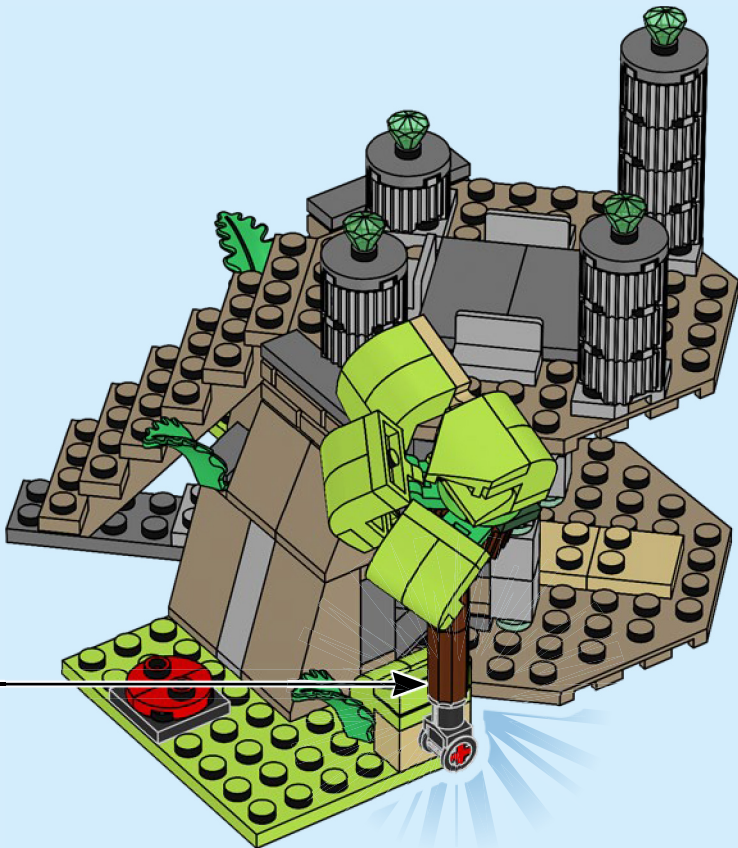



1x



2x

51

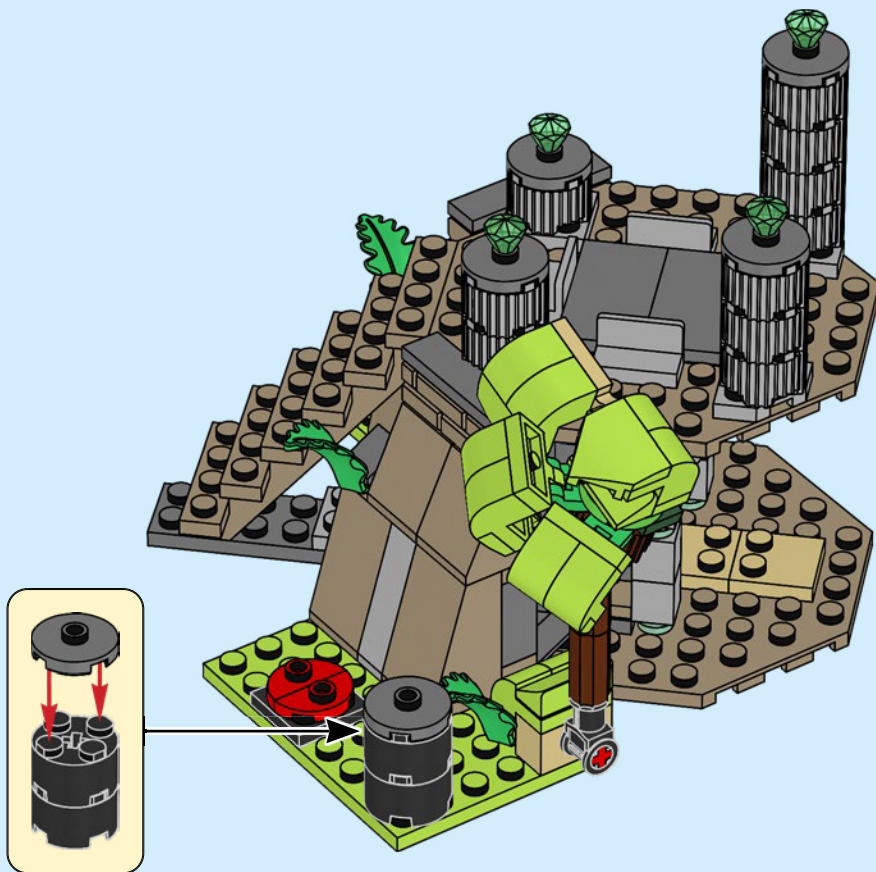

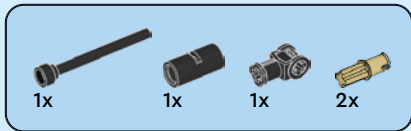

52

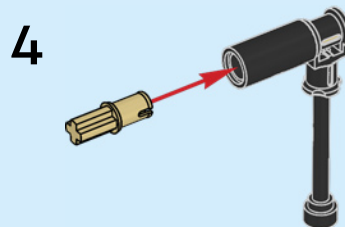
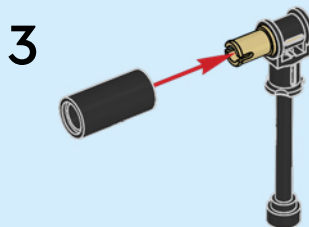
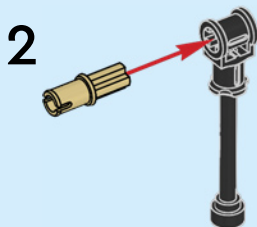
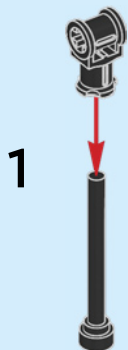

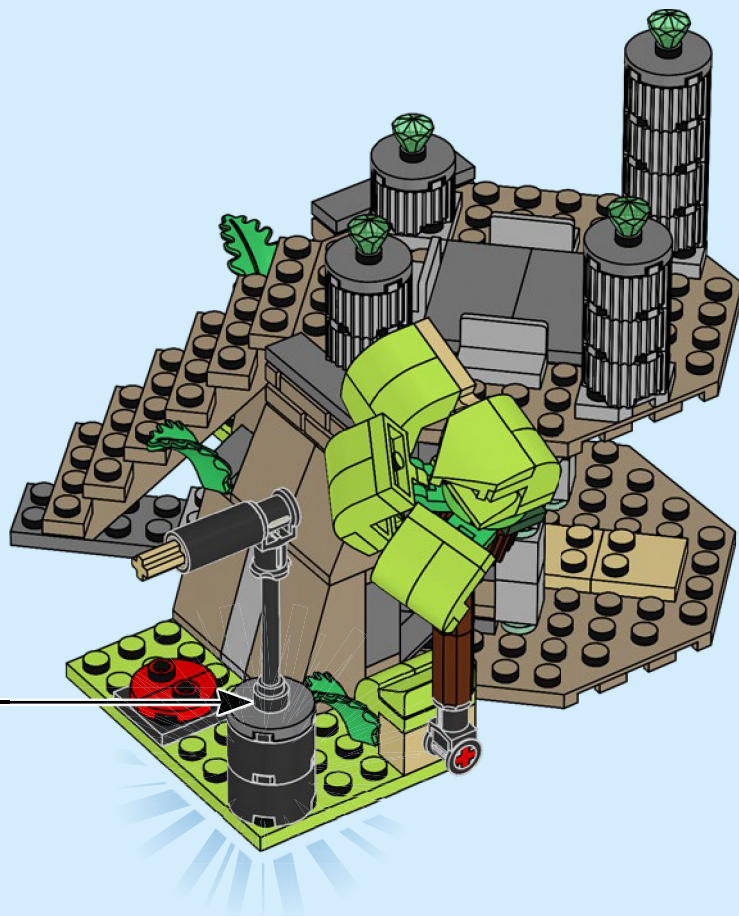

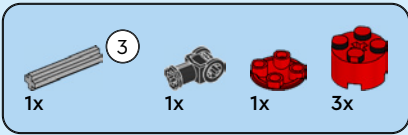

53

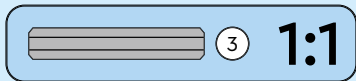
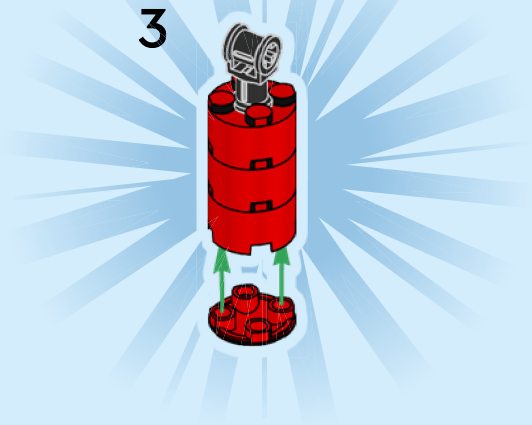
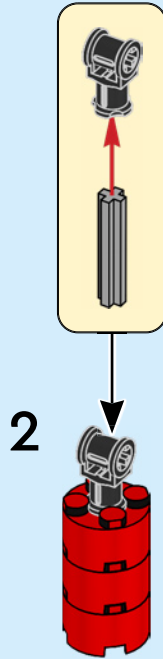
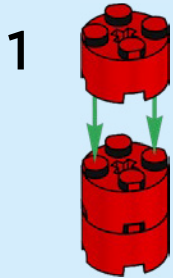

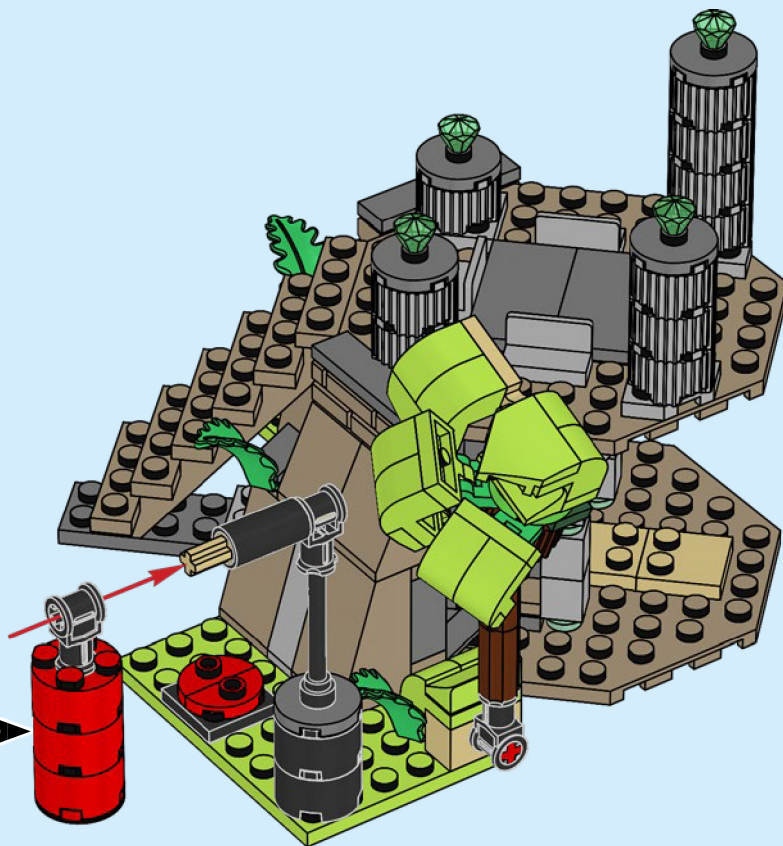





1x

54

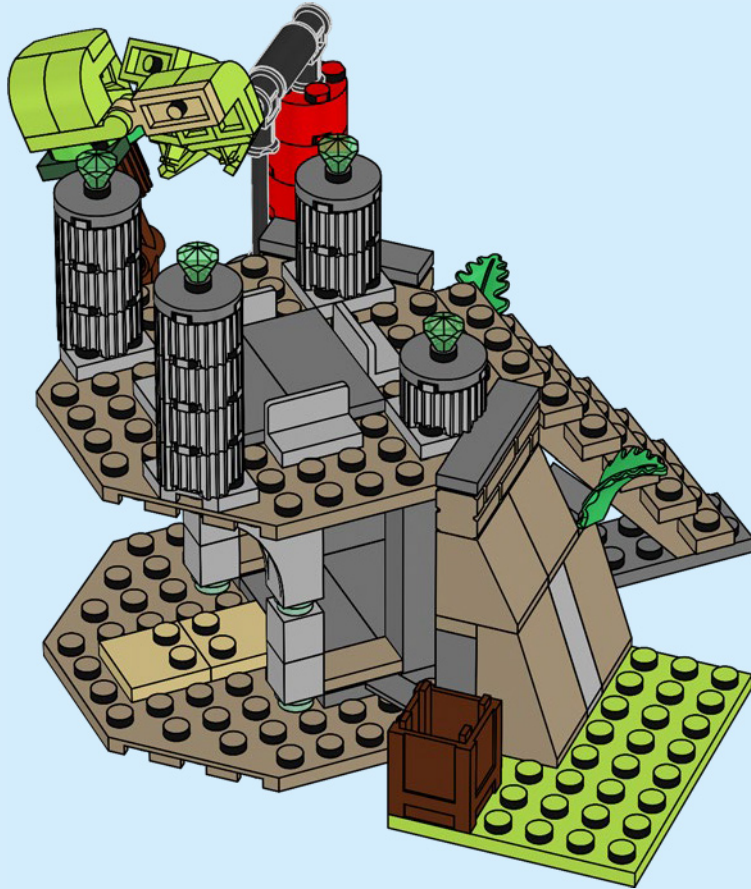



55



56



57

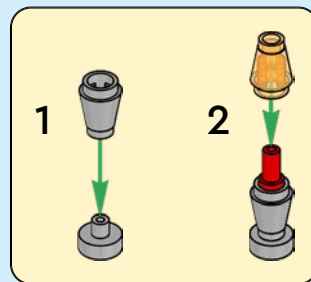

58

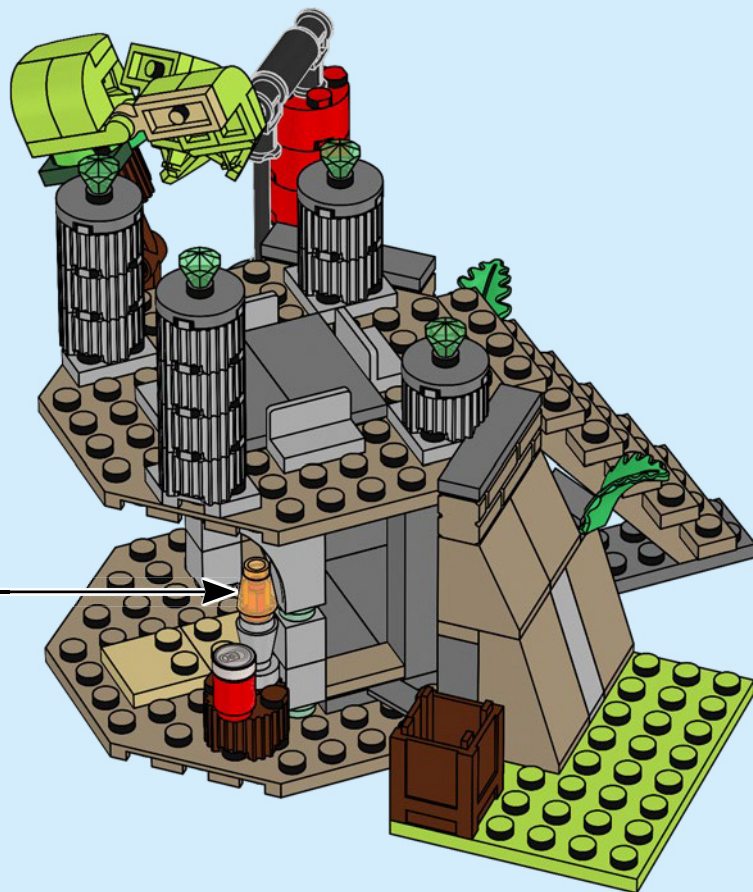



59

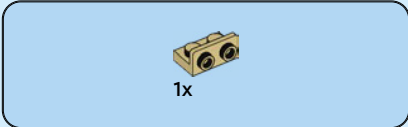

60

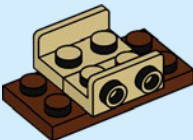

61

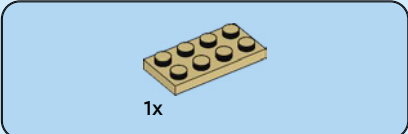
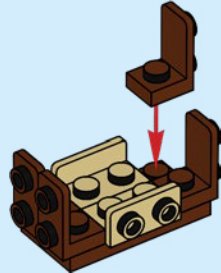

62

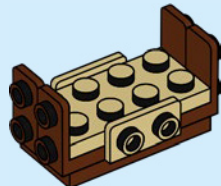

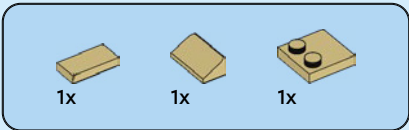

63

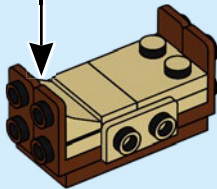
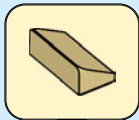

64

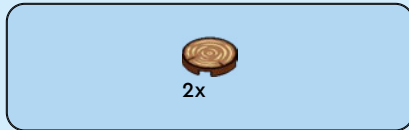
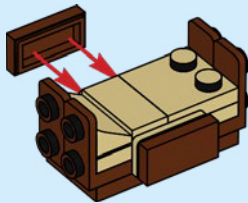

65

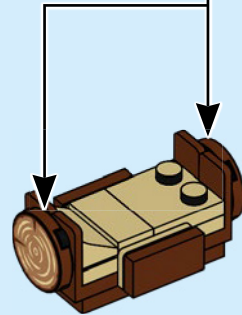

66

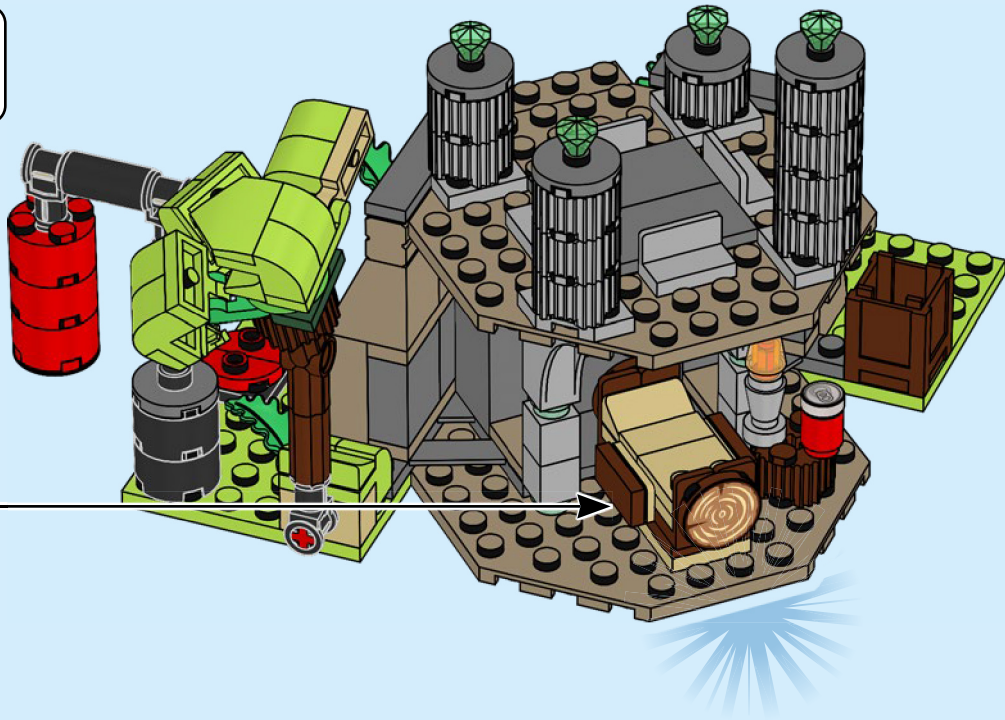

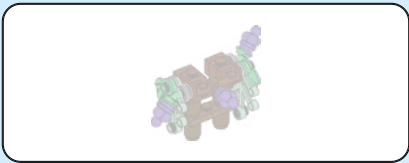

67

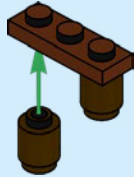

68

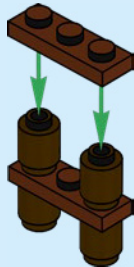

69

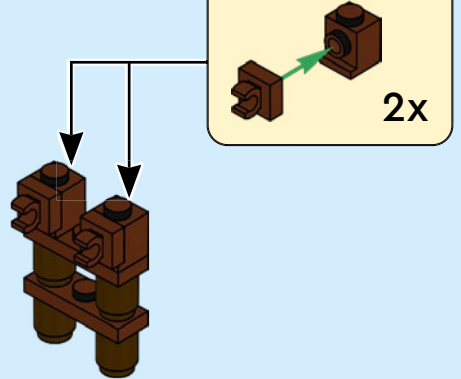

70

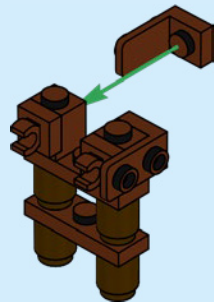

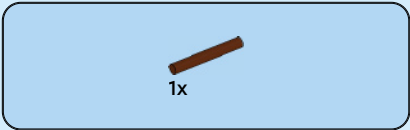

71

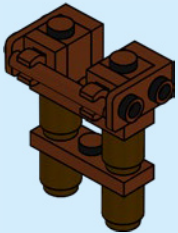

72

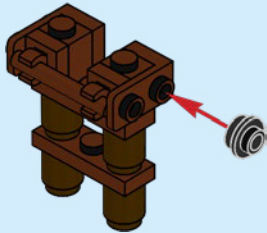

73

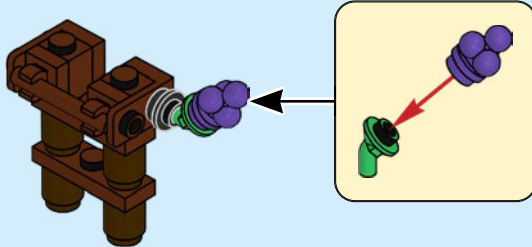

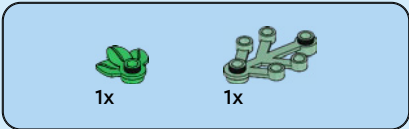

74

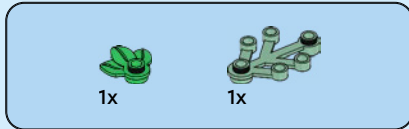
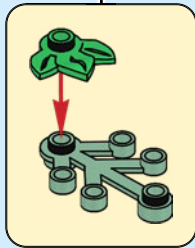
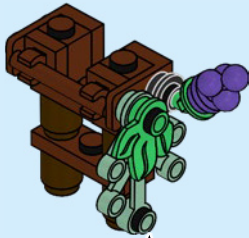

75

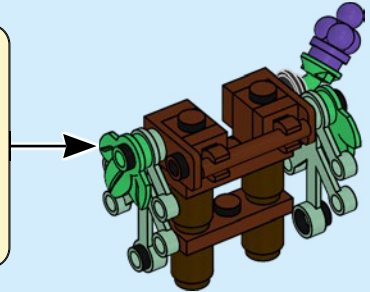
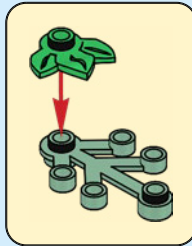
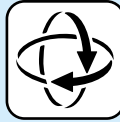

76

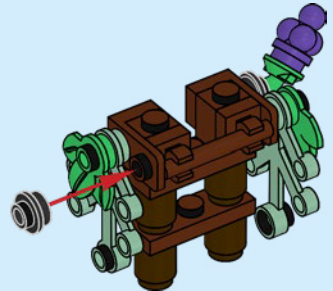



1x



1x

77

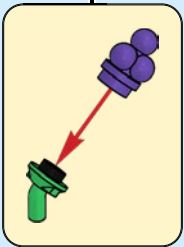
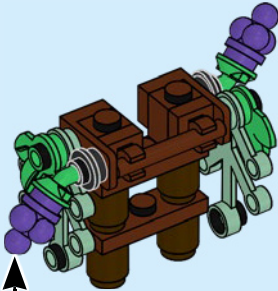

1x



1x

78

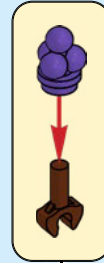
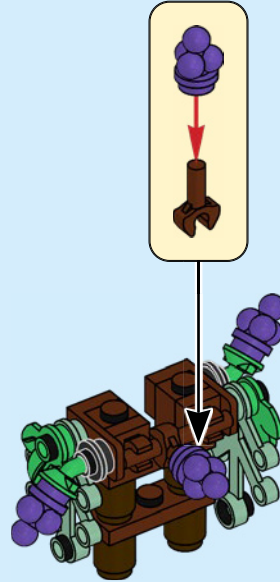

79

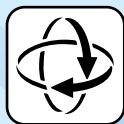

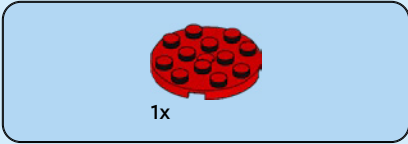
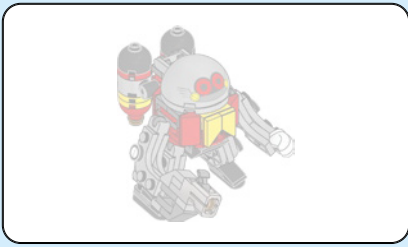

1



2

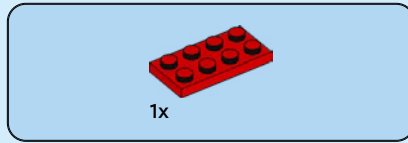
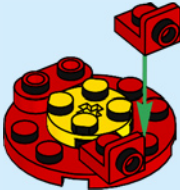

3

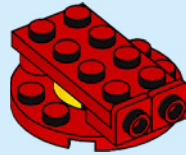

4

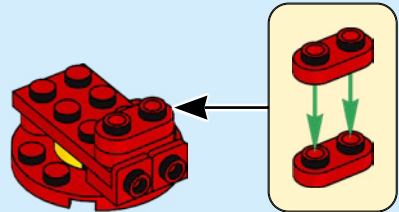

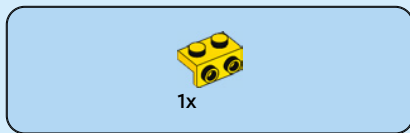

5

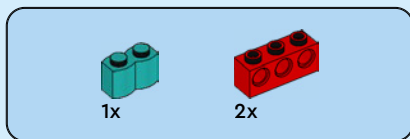
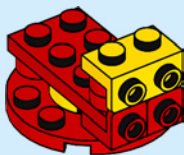

6

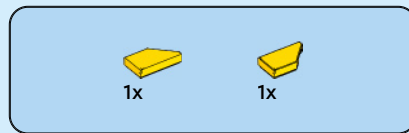
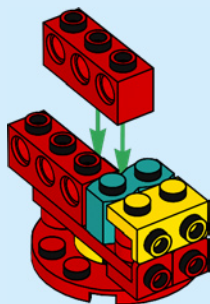

7

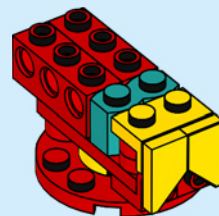

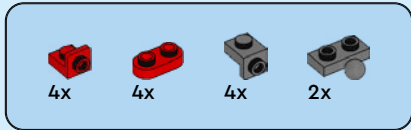

8

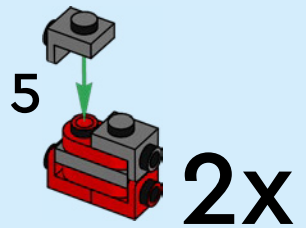
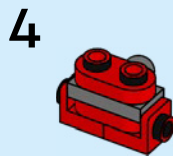
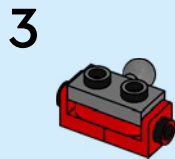
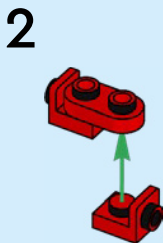
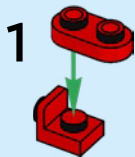

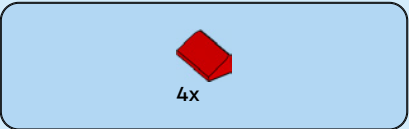

9

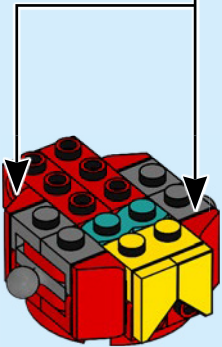
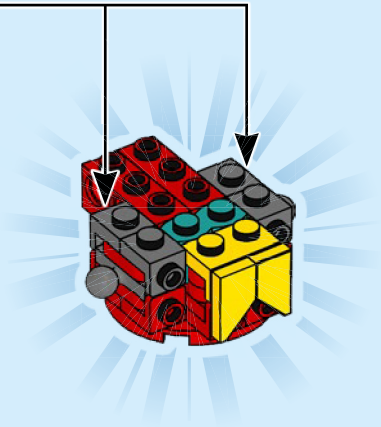
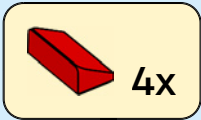

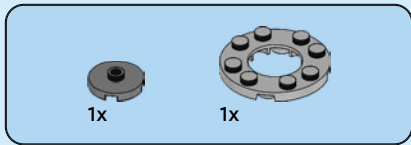

10

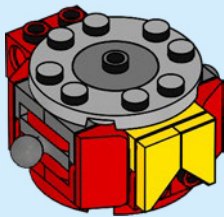

11

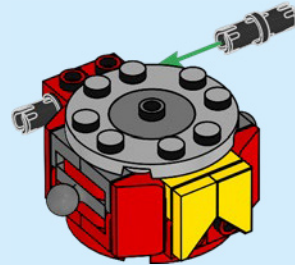



12

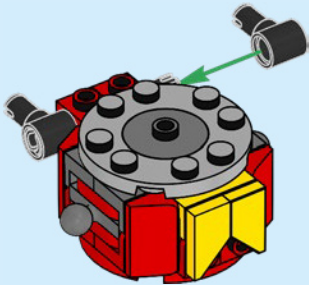

13

1

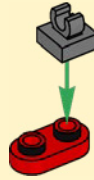

2

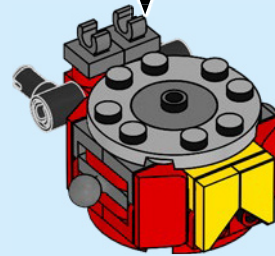
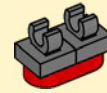



1x

14

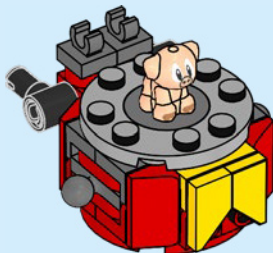

1x

15

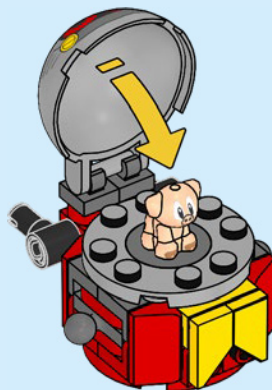

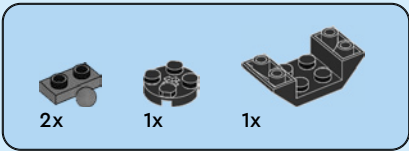

16

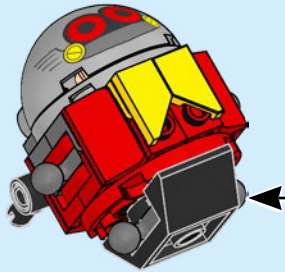
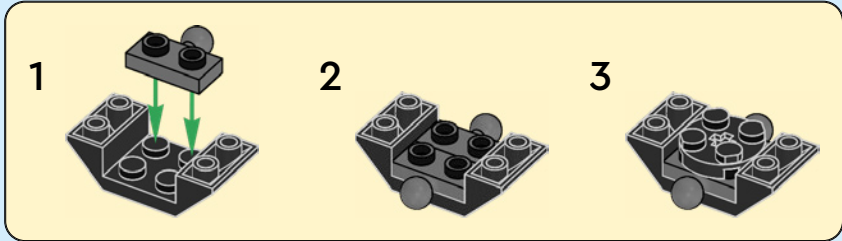

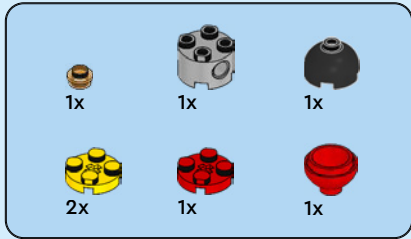

17

1



2

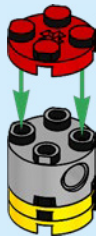

3



4



2x

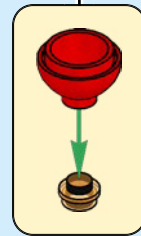

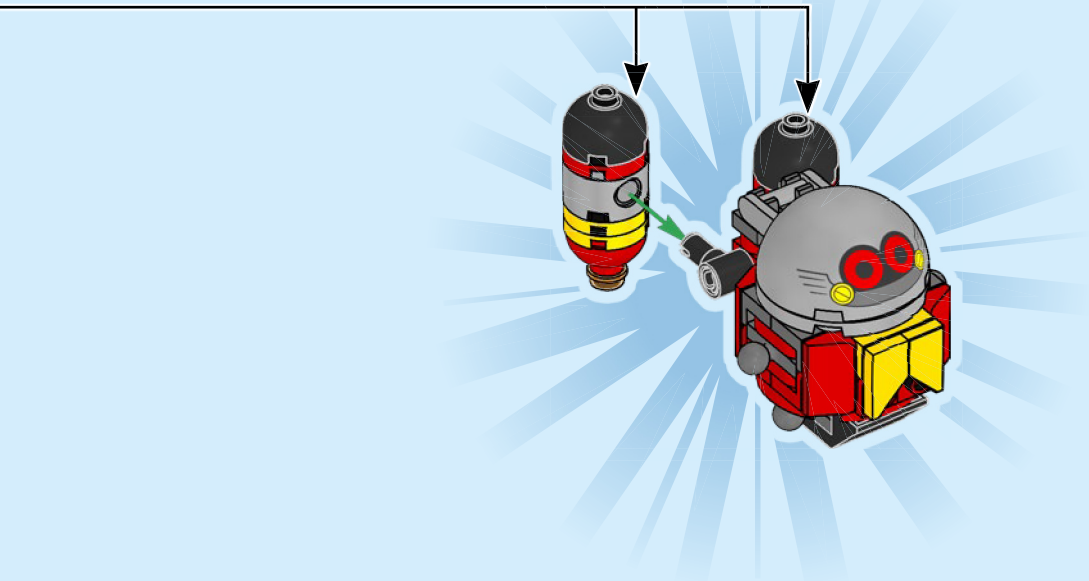

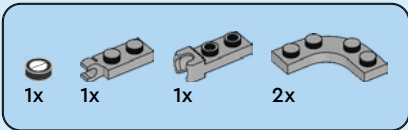

18

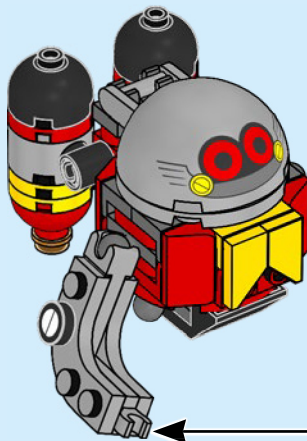
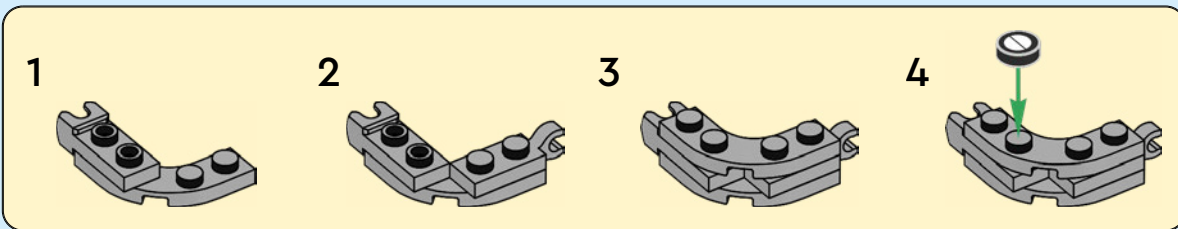

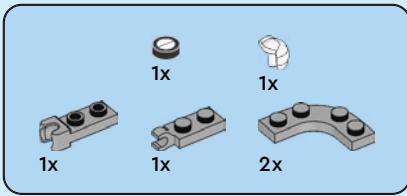

19

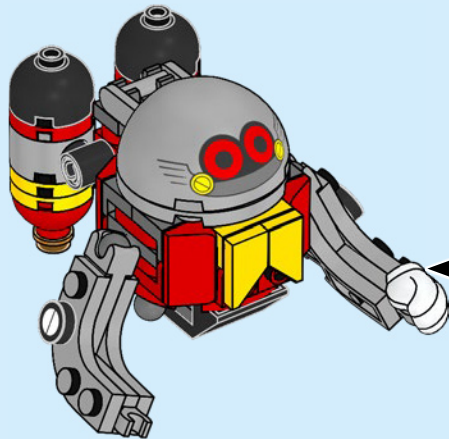
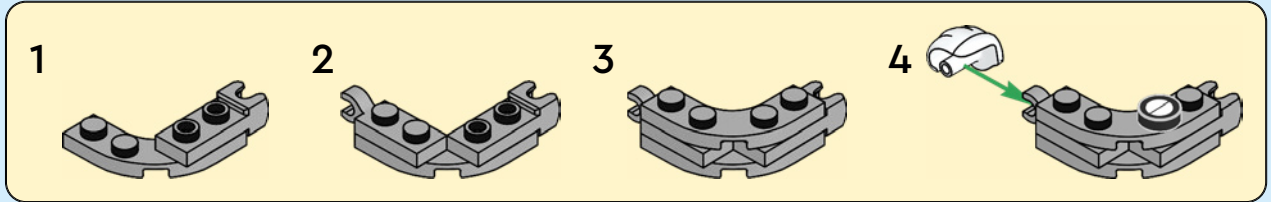

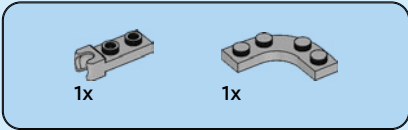

20

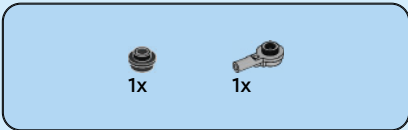
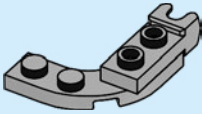

21

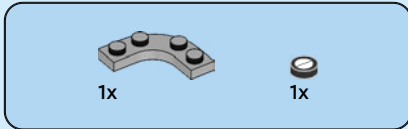
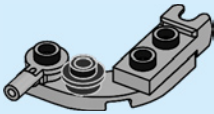

22

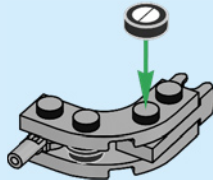

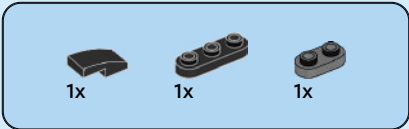

23

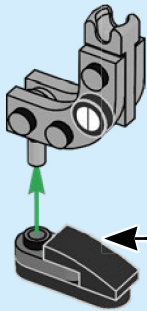
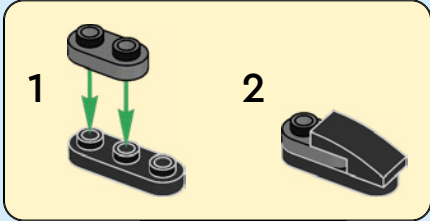

24

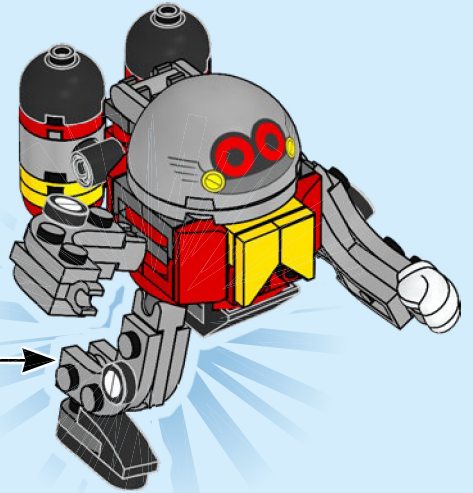

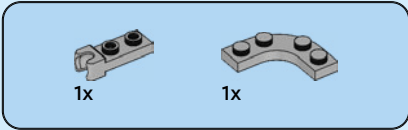

25

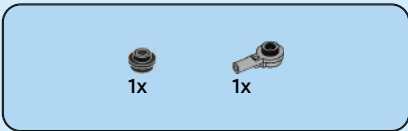
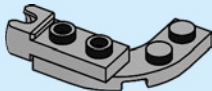

26

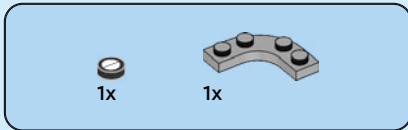
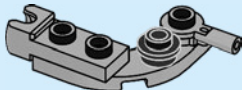

27

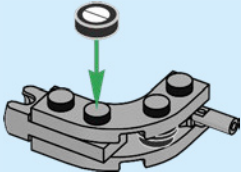

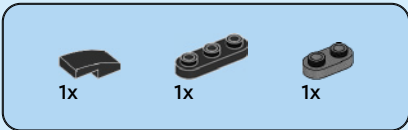

28

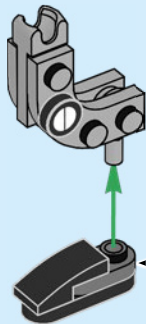
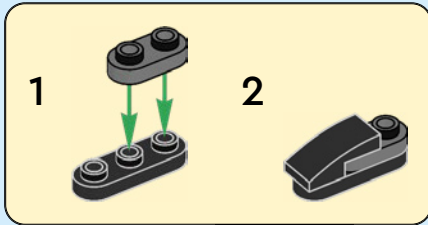

29

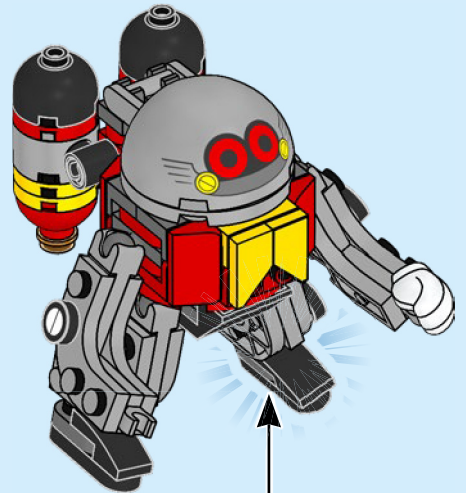

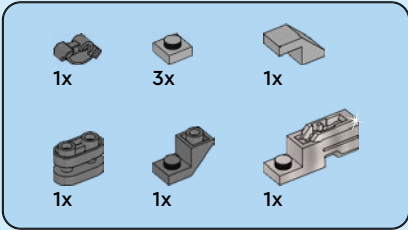

30

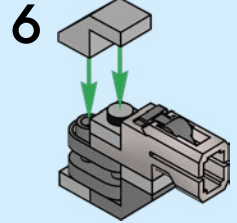
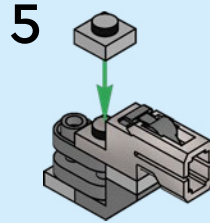
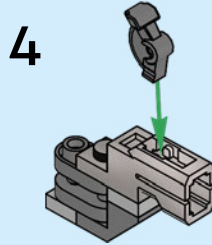
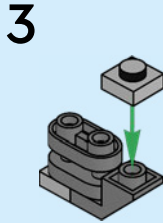
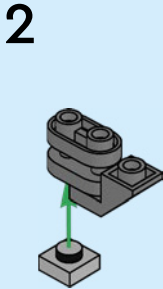
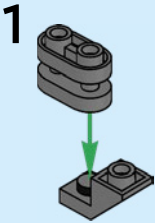

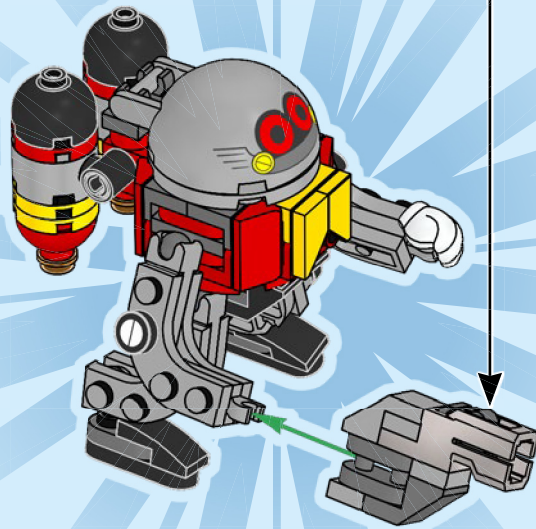

3x



31

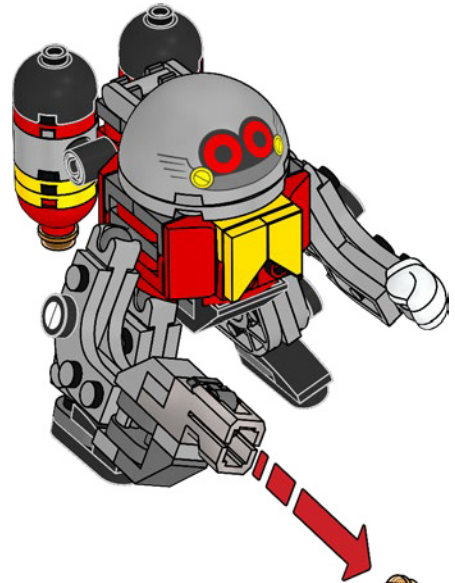
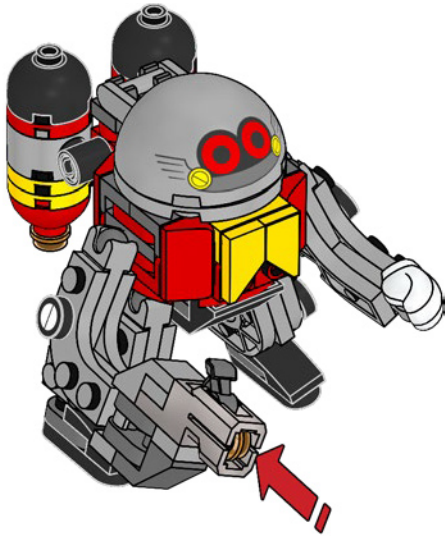





SONIC™

THE HEDGEHOG

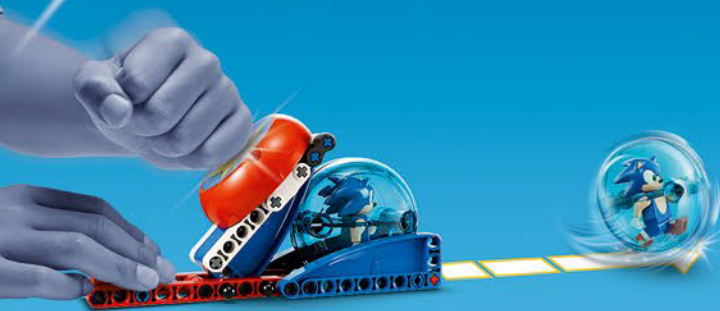

EXPLORE MORE



7 LEGO.com/sonic



- | | | | | | |
|---------------|---------------|---------------|---------------|----------------|---------------|
| 1x
6506160 | 2x
6510057 | 1x
6474530 | 4x
6168646 | 2x
6510190 | 4x
6013102 |
| 2x
6431337 | 8x
6210269 | 1x
6189130 | 4x
6478985 | 2x
6229130 | 2x
4496699 |
| 2x
6248490 | 2x
6065839 | 1x
4515348 | 1x
403226 | 2x
6253140 | 2x
4616593 |
| 1x
6510482 | 4x
4651524 | 2x
302021 | 2x
6279875 | 3x
6411022 | 4x
4616593 |
| 1x
4624086 | 4x
403221 | 1x
6510151 | 2x
6429056 | 1x
6138624 | 4x
6000852 |
| 2x
4666579 | 4x
4142865 | 1x
6294771 | 2x
614326 | 2x
4537251 | 4x
6000852 |
| 1x
4114026 | 1x
4278275 | 1x
6078279 | 2x
6282140 | 2x
6025026 | 4x
4626904 |
| 1x
6219794 | 1x
6173922 | 5x
403224 | 3x
6331716 | 10x
6411328 | 2x
6502374 |
| 2x
6313611 | 3x
614321 | 2x
6331822 | 1x
6173119 | 2x
6334046 | 2x
6502374 |
| 1x
6372047 | 1x
6508124 | 1x
6510138 | 2x
6047276 | 4x
6442920 | 1x
6506126 |
| 3x
6221467 | 1x
6492337 | 2x
6247387 | 2x
6428168 | 1x
6133859 | 1x
6506126 |
| 1x
4114309 | 2x
6494104 | 1x
6185994 | 1x
368026 | 1x
6129601 | 2x
6288246 |
| 1x
6452585 | 1x
6453242 | 1x
6116606 | 1x
395726 | 2x
6100914 | |
| 6x
6249907 | | | 1x
4188534 | | |
| 1x
6399645 | | | | | |

1x
4529241

1x
6258831

4x
4211389

3x
4211399

2x
6227897

10x
4650645

1x
4540203

2x
6372076

4x
6186657

4x
6146223

2x
4211494

1x
6213378

2x
6319336

1x
4211376

1x
4211815

4x
6043639

2x
6225228

1x
4211419

1x
6167798

8x
6383110

1x
4211395

1x
6478984

1x
4618874

1x
6439053

2x
6348057

2x
4225469

6x
6341553

2x
6036503

2x
6182435

1x
4531751

2x
4211151

1x
6428805

1x
4520638

1x
6261388

2x
4211152

1x
4211186

1x
6395635

6x
6115080

4x
6039479

2x
6069164

1x
6435267

4x
4210978

4x
4211075

2x
4211053

4x
4560184

2x
6133811

1x
4211002

2x
4504378

4x
6413106

2x
6344022

1x
6360675

1x
6390673

2x
6221607

1x
6172233

5x
6240227

5x
6278447

7x
6403175

2x
6328339

4x
6247788

1x
6325980

1x
6174946

1x
6501235

1x
6443212

1x
6443196

4x
6022105

1x
6322904

1x
6345950

 LEGO.com/service

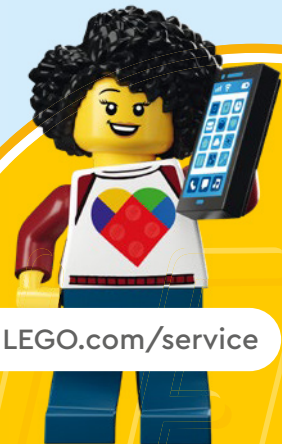

YOU COULD **WIN**



Scan this QR code or go to **LEGO.COM/PRODUCTFEEDBACK** and give us your short feedback about this LEGO® set for a chance to win a cool LEGO prize.

Terms and Conditions apply*

EN: YOU COULD WIN. Terms and Conditions apply* **DE: Du könntest GEWINNEN.** Es gelten die Teilnahmebedingungen* **FR: Tu pourrais GAGNER.** Des conditions s'appliquent* **IT: Potresti VINCERE tu.** Termini e condizioni sono applicabili* **ES: Puedes GANAR.** Aplican términos y condiciones* **PT: Poderá GANHAR.** Aplicam-se termos e condições* **ZH: 轻松获奖. 条款和条件适用*** **PL: Szansa na WYGRANĄ.** Obowiązują warunki korzystania* **CS: Máte šanci VYHRÁT.** Platí všeobecné smluvní podmínky* **SK: Máte šancu VYHRAŤ.** Platia všeobecné zmluvné podmienky* **HU: TE IS NYERHETSZ.** Felhasználási feltételek érvényesek* **RO: Ai putea CÂȘTIGA.** Se aplică termeni și condiții* **BG: Можете да СПЕЧЕЛИТЕ.** Има определени правила и условия* **LV: Tu vari LAIMĒT.** Ir spēkā noteikumi un nosacījumi.* **ET: Sul on võimalus VÕITA.** Kehtivad tingimused* **LT: Jūs galite LAIMĖTI.** Taikomos sąlygos*

*[LEGO.com/productfeedback-terms](https://www.lego.com/productfeedback-terms)

LEGO and the LEGO logo are trademarks of the LEGO Group. ©2024 The LEGO Group.

©SEGA. All rights reserved. SEGA is registered in the U.S. Patent and Trademark Office.
SEGA and SONIC THE HEDGEHOG are either registered trademarks or trademarks of SEGA CORPORATION.

6530633