



# MINECRAFT

21252







LEGO® Builder



[LEGO.com/sustainable-packaging](https://LEGO.com/sustainable-packaging)



 <sup>FR</sup> **DONNEZ**  
OU  
**RECYCLEZ**

 OU  OU 

ASSOCIATION MAGASIN DÉCHÈTERIE

Adresses sur [quefairedemesdechets.fr](https://quefairedemesdechets.fr)

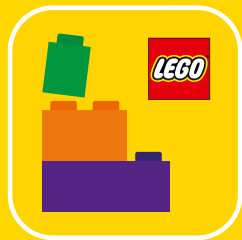

Q LEGO® Builder

# BUILDER



Apple and the Apple logo are trademarks of Apple Inc., registered in the U.S. and other countries and regions. App Store is a service mark of Apple Inc. Google Play and the Google Play logo are trademarks of Google LLC. Tencent and the Tencent logo are trademarks of Tencent Inc.

Q [LEGO.com/devicecheck](https://lego.com/devicecheck)

**EN** Ask parents' permission before going online | **DE** Eltern um Erlaubnis bitten, bevor du online gehst | **FR** Demande l'autorisation d'un parent avant d'aller en ligne | **IT** Chiedi il permesso ai tuoi genitori prima di andare online | **ES** Pídeles permiso a tus papás antes de conectarte a Internet | **PT** Pede autorização aos pais antes de acederes online | **ZH** 上网前应先征得父母的同意 | **PL** Poproś rodziców o zgodę, zanim wejdiesz do Internetu | **CS** Než půjdeš na internet, požádej rodiče o svolení | **SK** Skôr než pôjdeš na internet, vypýtaj si povolenie od rodičov | **HU** Kérj szülői engedélyt, mielőtt online csatlakoznál! | **RO** Cere permisiunea părinților înainte de a te conecta online | **BG** Поискайте разрешение от родител, преди да влезете онлайн | **LV** Pirms došanās tiešsaistē palūdz atļauju vecākiem | **ET** Enne Interneti kasutamist küsi vanematelt luba | **LT** Prieš prisijungdami prie interneto, atsiklauskite tėvų



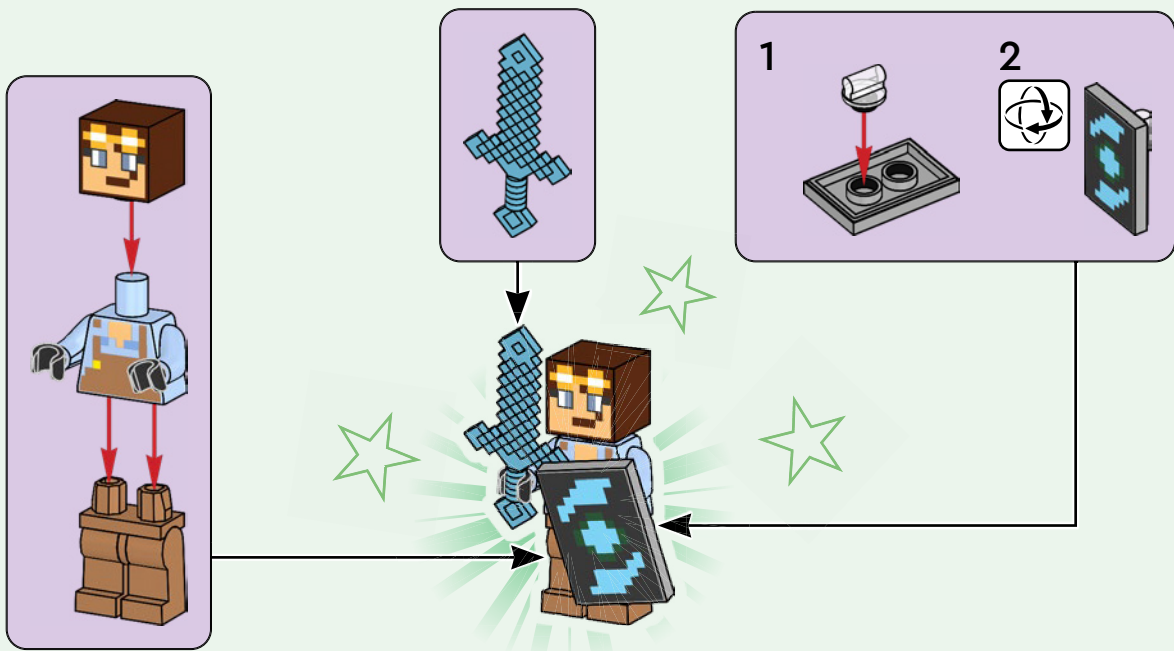

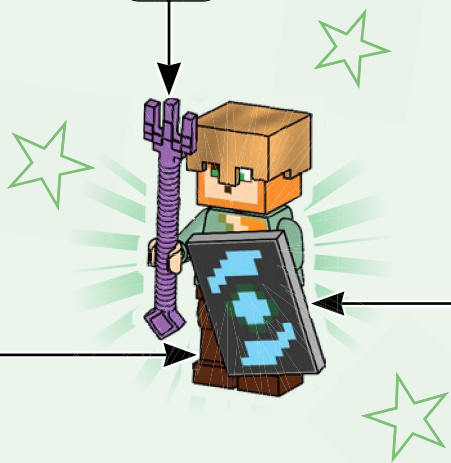
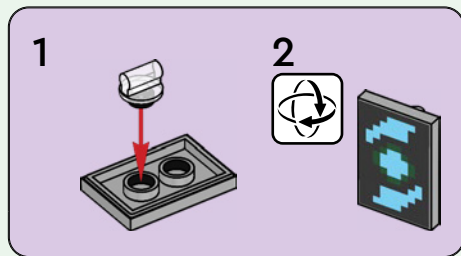
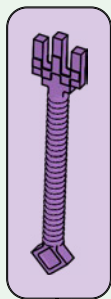
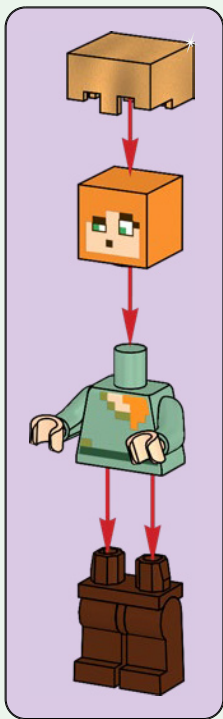

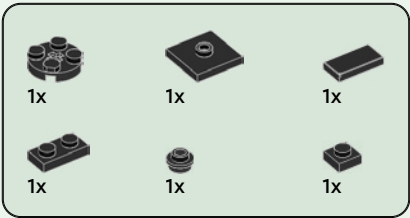

1

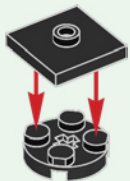

2

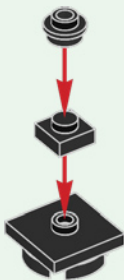

3

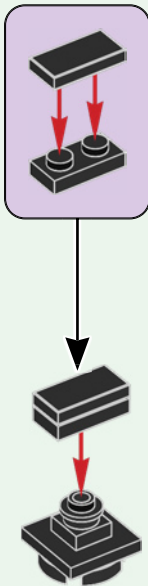

4



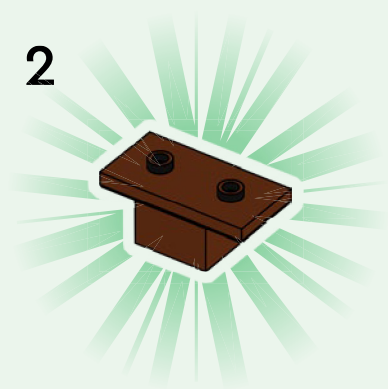
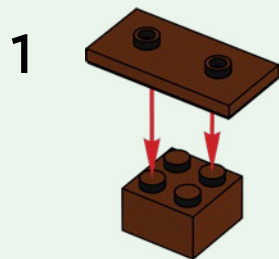
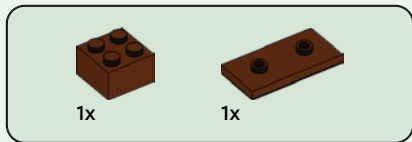



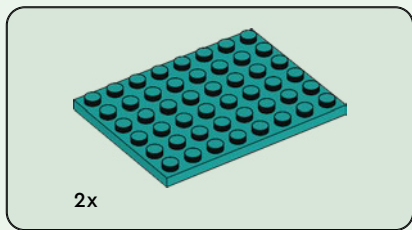
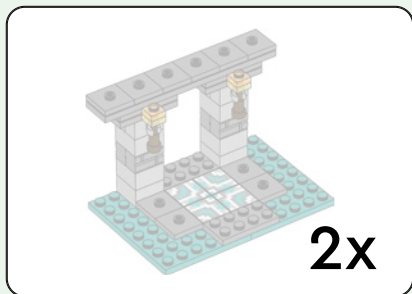

1

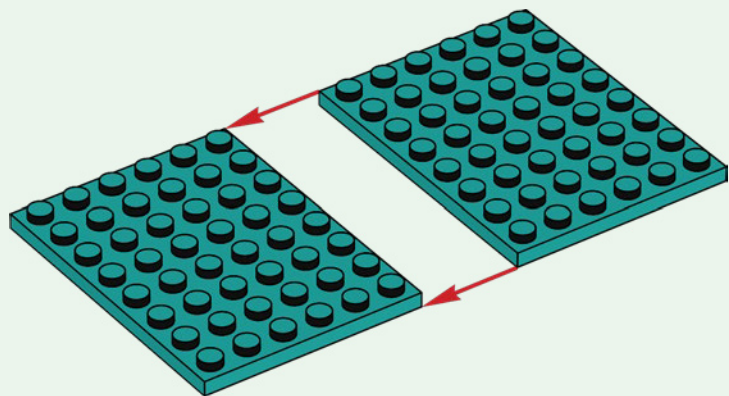



2x

2

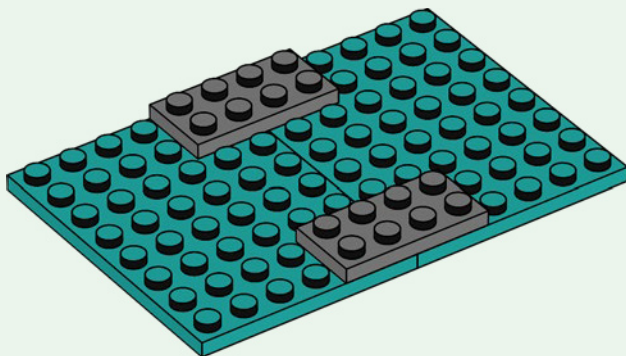



4x

3

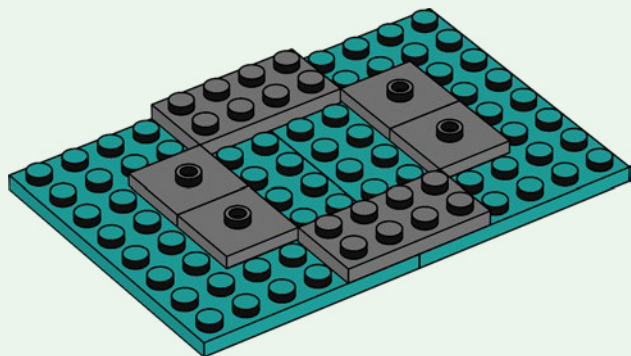

4x

4

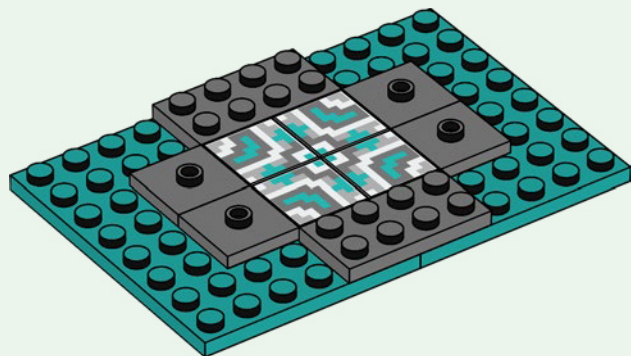



2x



6x



4x



2x



2x

5

1

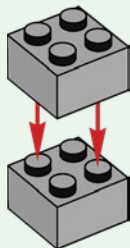

2

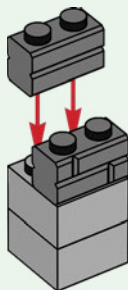

3

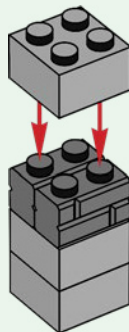

4

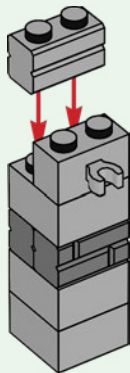

2x

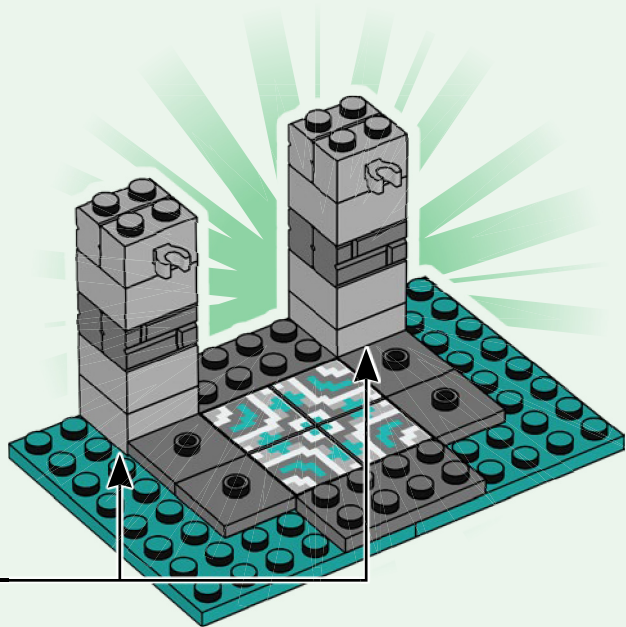

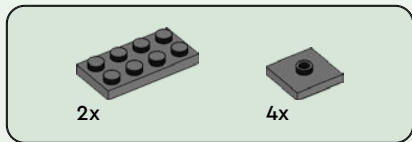

6

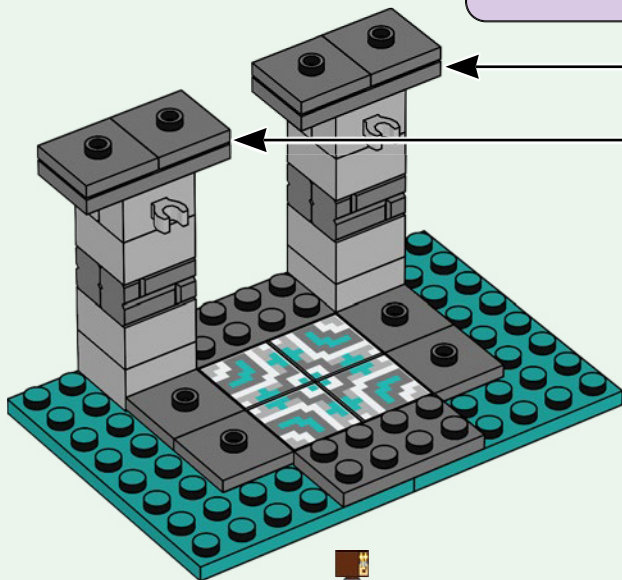
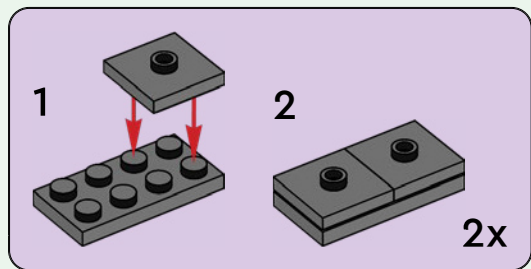

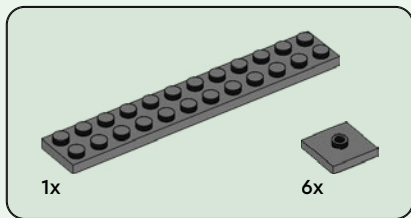

7

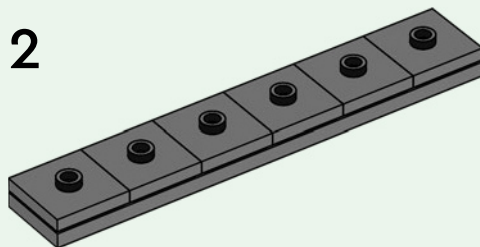
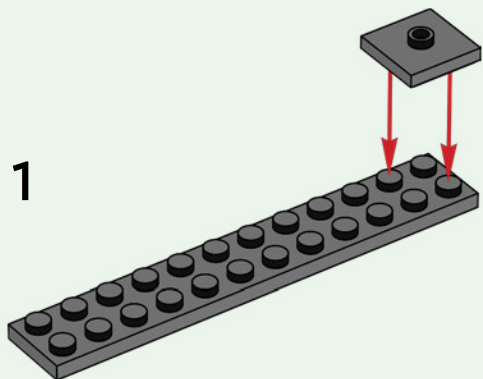

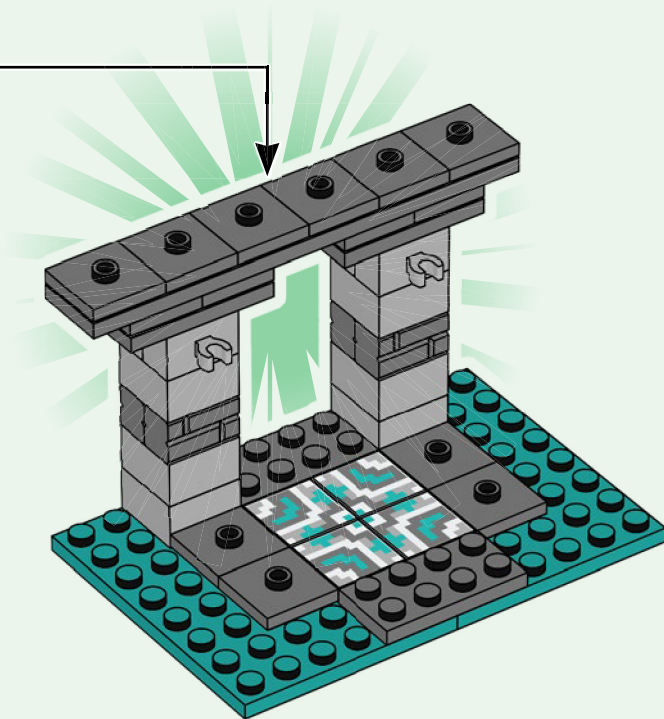





8

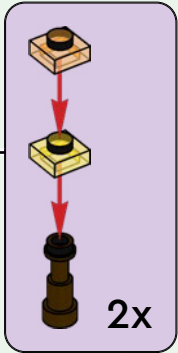
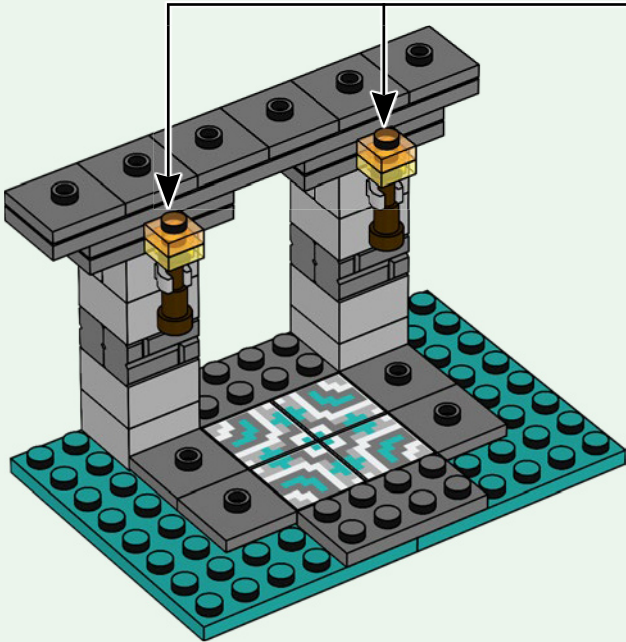

2x



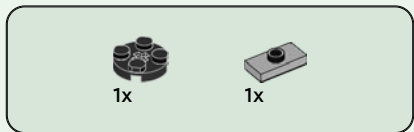

1

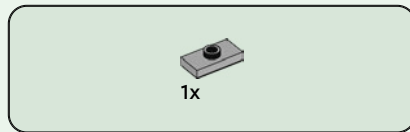
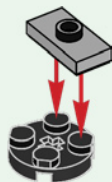

2





1x

3

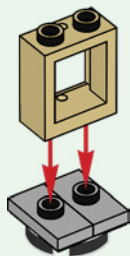

1x



1x

4

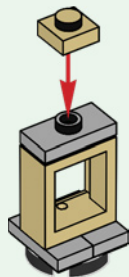

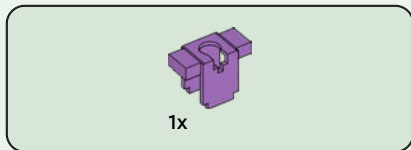

5

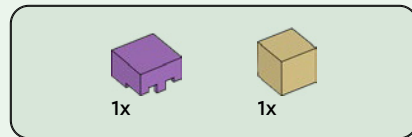
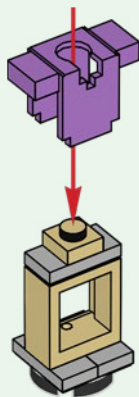

6

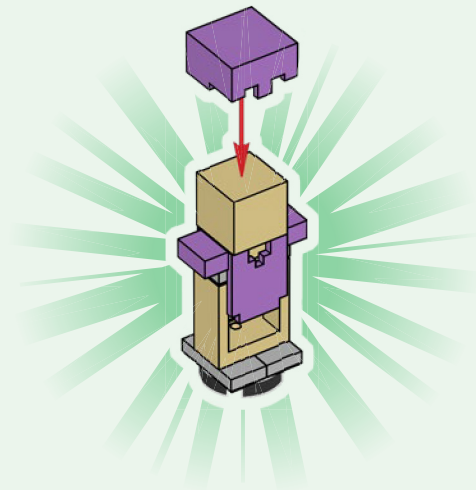

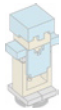

1x



1x

1

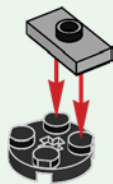

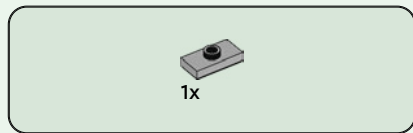

2

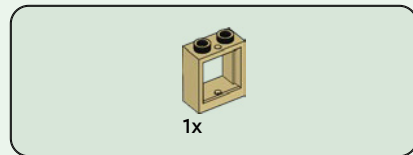

3

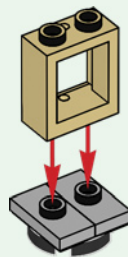



1x



1x

4

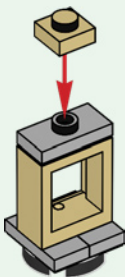



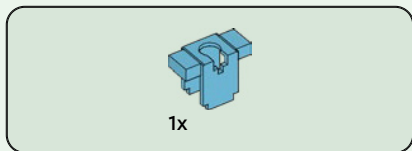

5

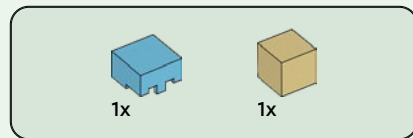
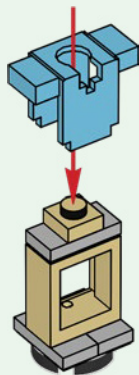

6

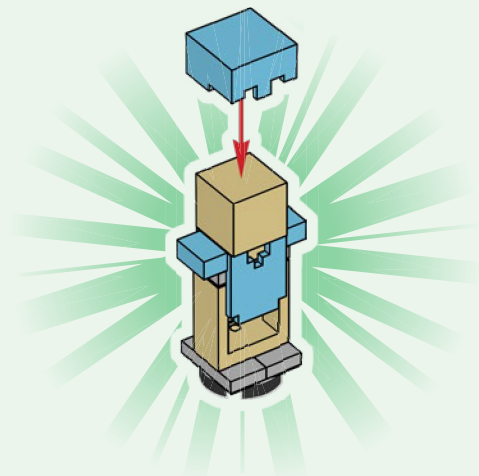

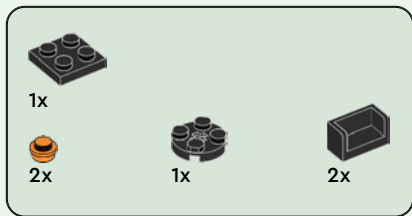

1

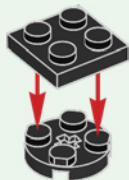

2

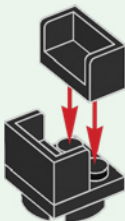

3

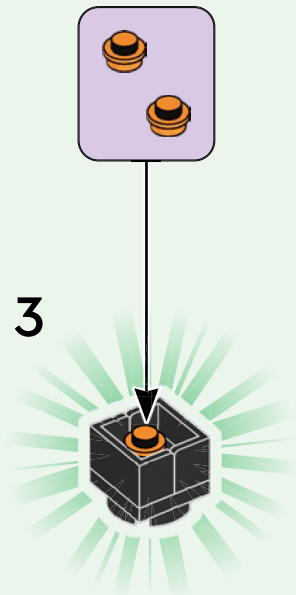

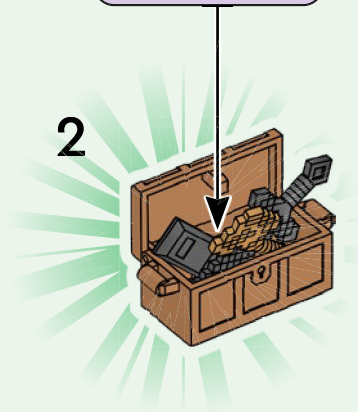
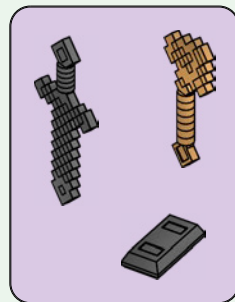
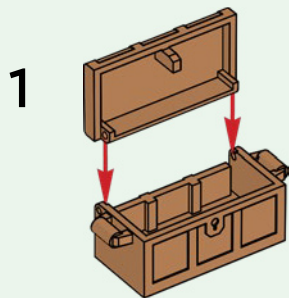
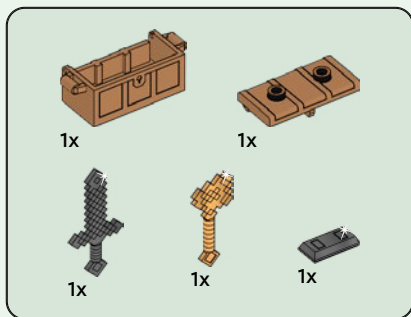

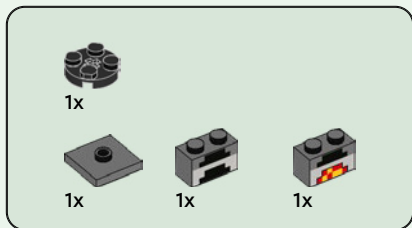

1

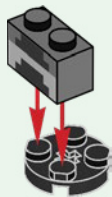

2



3





1x



1x

1

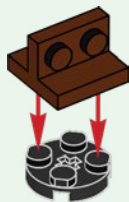

2x

2

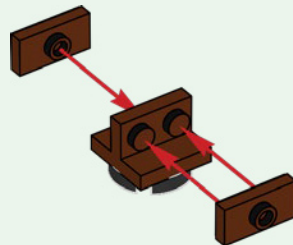



1x



1x

3

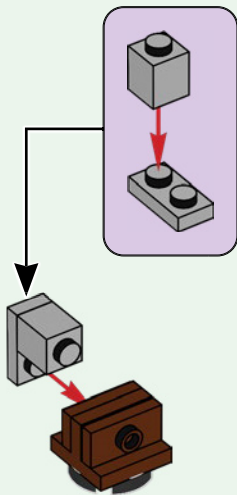

1x

4

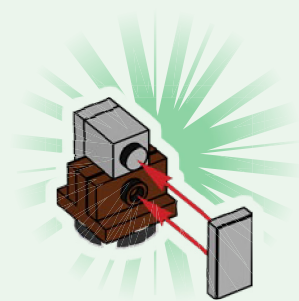

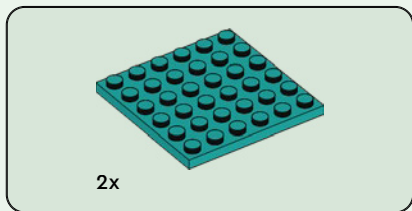
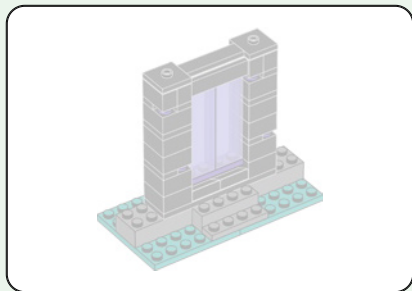

1

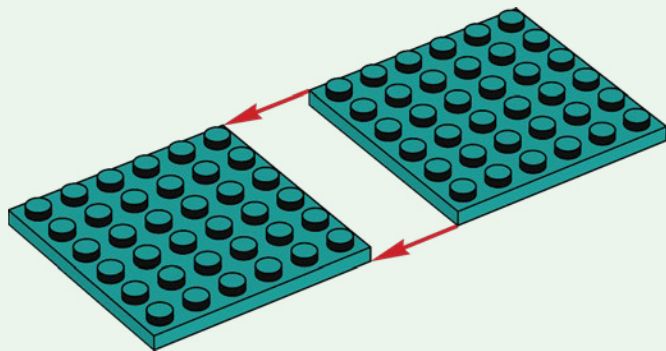



2x

2

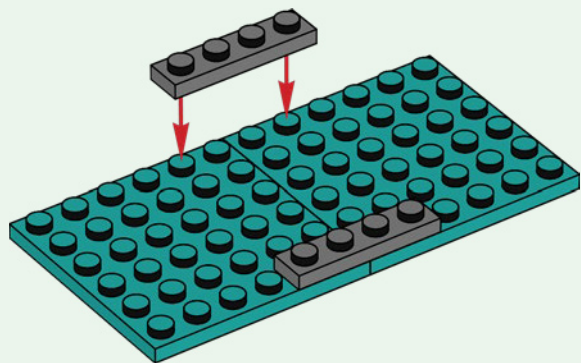

2x

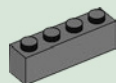

2x

3

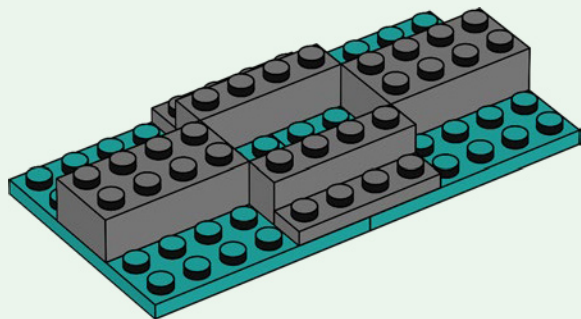



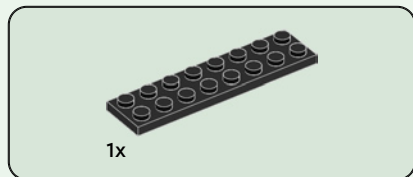

4

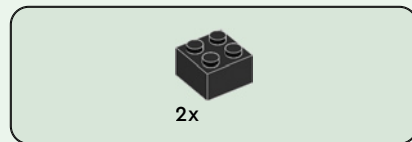
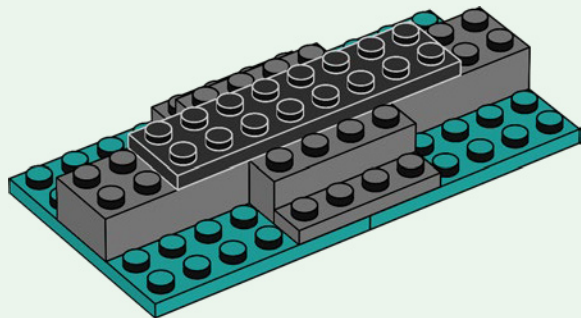

5

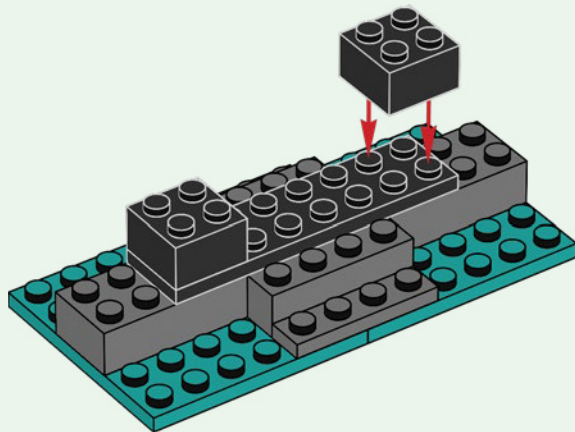



4x

6

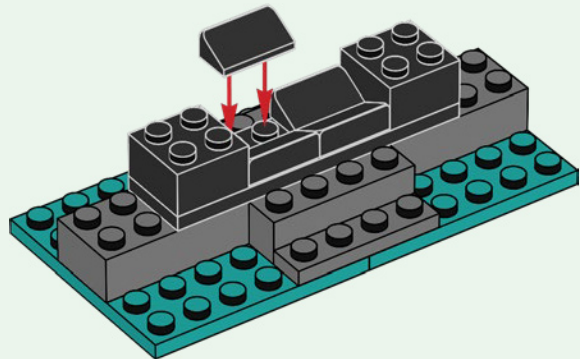

2x

7

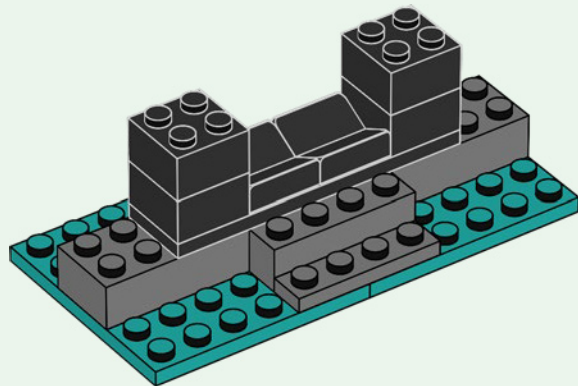



2x



2x

8

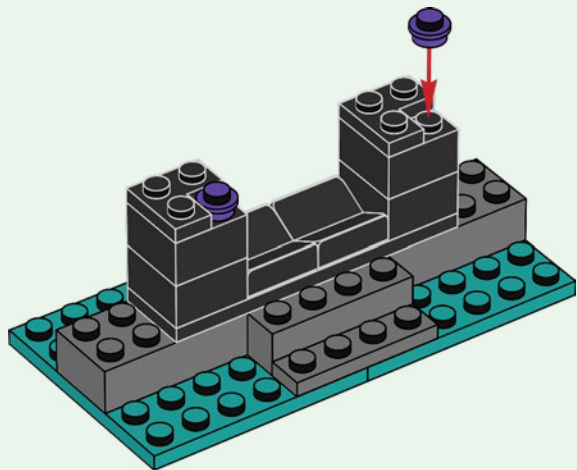

2x

9

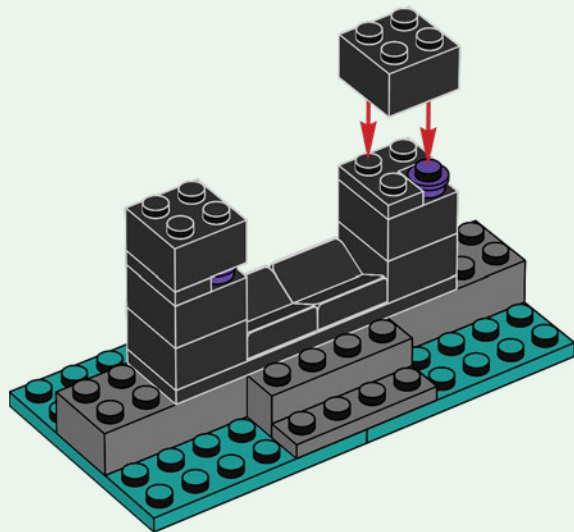



2x

10

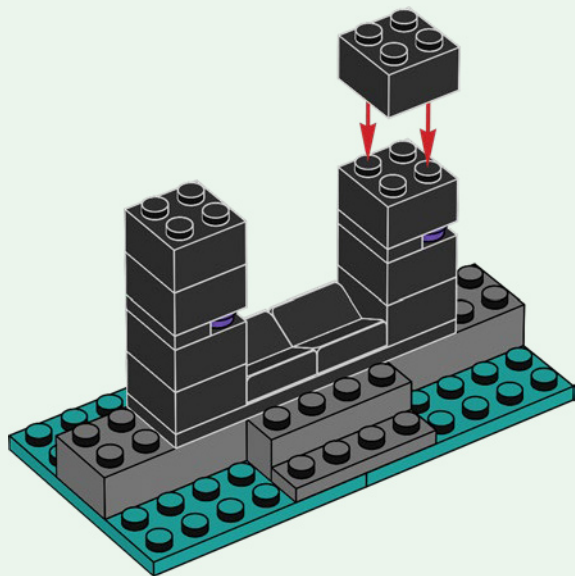

2x



2x

11

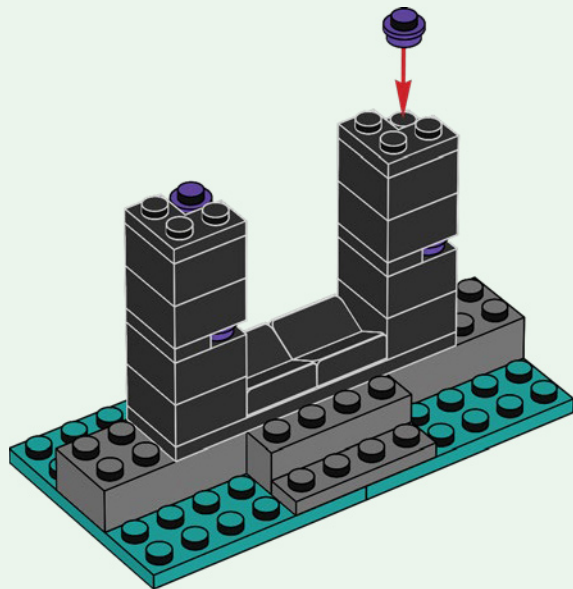



2x

12

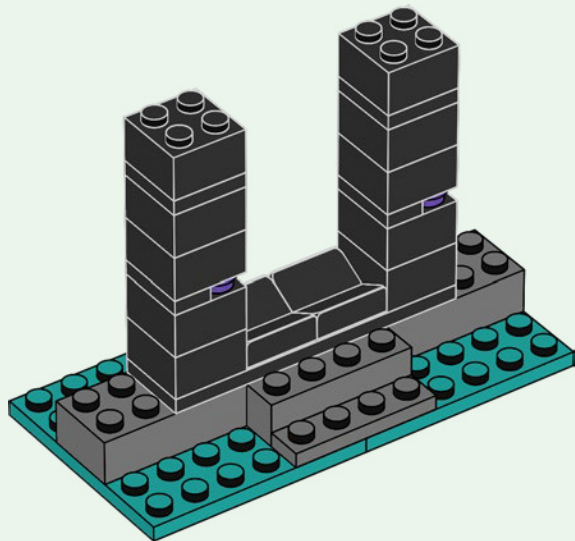

2x



2x

13

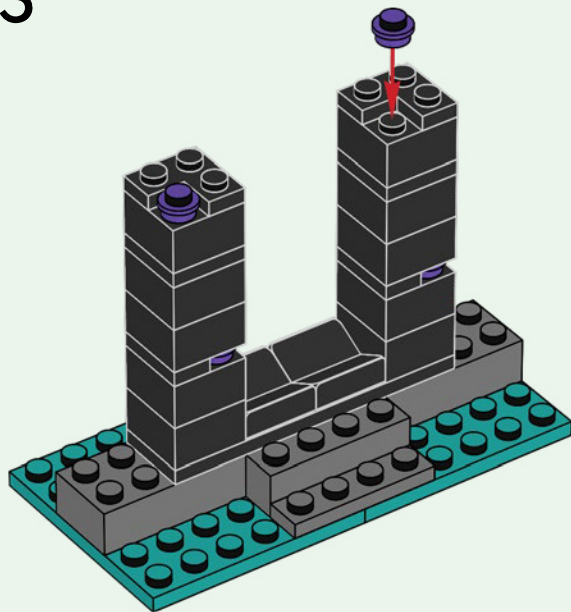

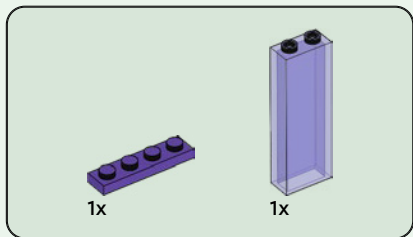

14

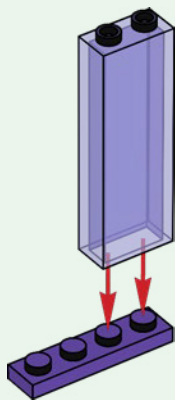

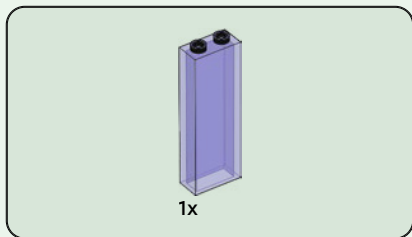

15

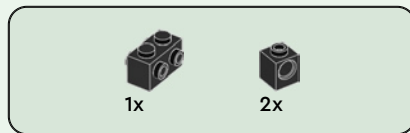
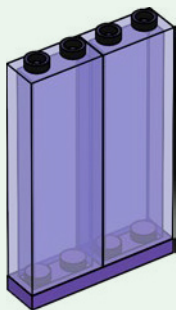

16

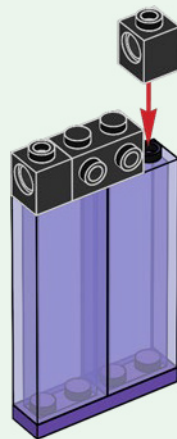



1x

17

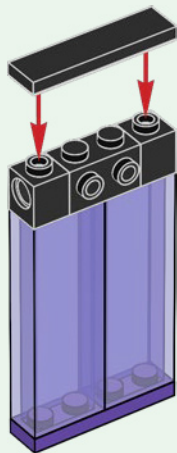

2x

18

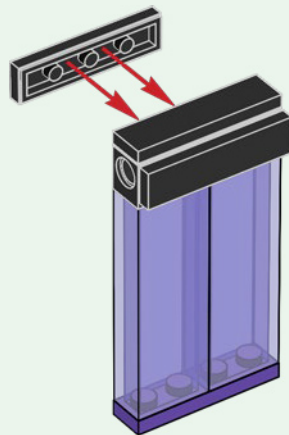





2x

19

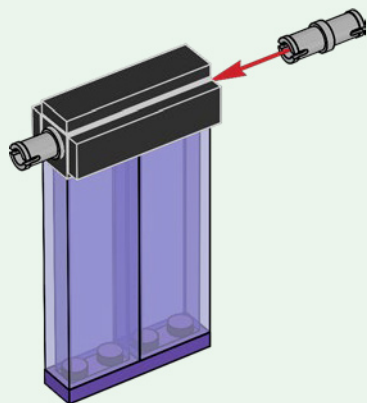

2x

20

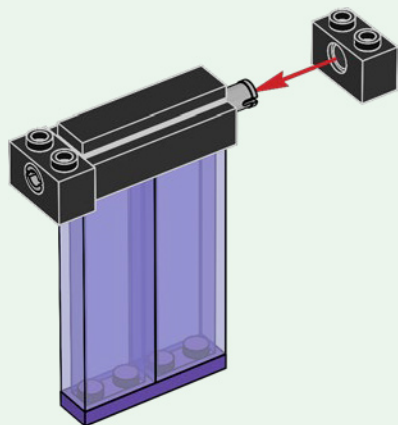

21

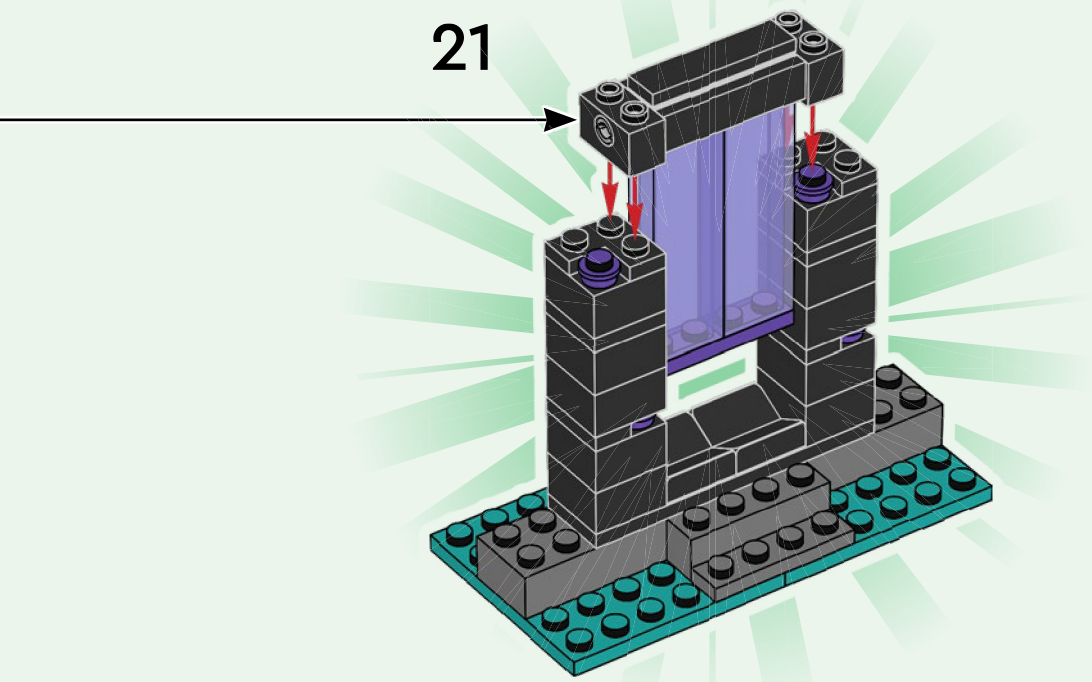



2x

22

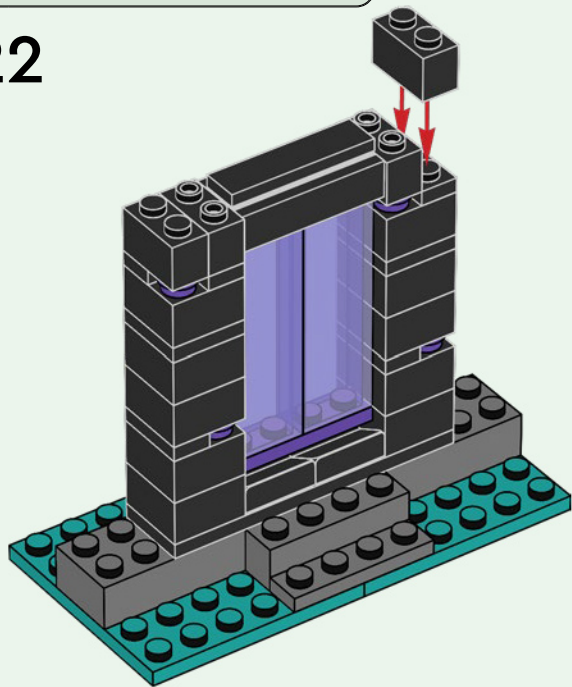

2x

23

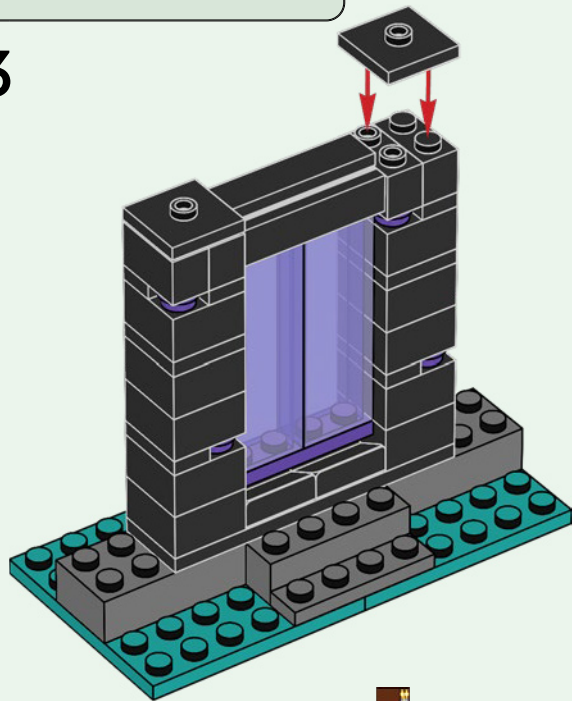





Rebuild  
the  
world™





# MINECRAFT

21256



21257



21251

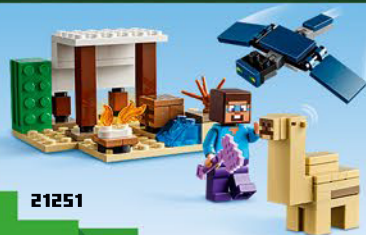

21255



21252



21253



21254



# MINECRAFT

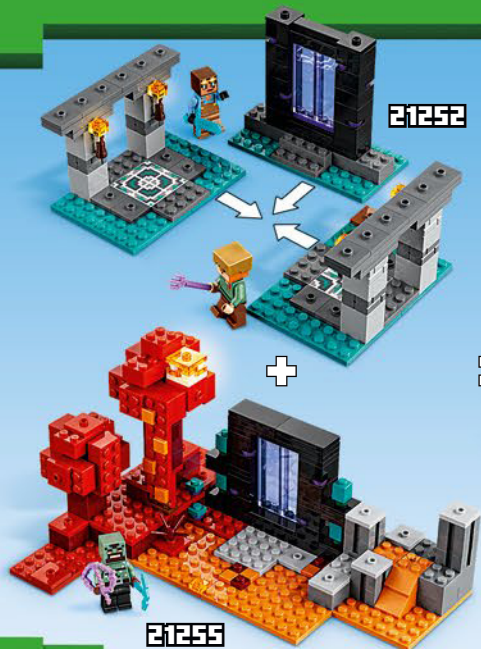

Combine sets to expand your play!  
Kombiniere Sets für noch mehr Spielspaß!  
Combine les niveaux pour étendre ton expérience de jeu !  
Combina i set per espandere il tuo gioco!  
¡Combina sets para jugar mucho más!  
Combina sets para expandir os teus momentos de diversão!  
组合系列套装, 增强玩乐体验!  
Łącz zestawy i baw się jeszcze lepiej!



Kombinujte stavebnice a rozšiřujte svou hru!  
Kombinujte stavebnice a rozšiřujte herné možnosti!  
A készletek egyesítésével bővítsd a játékot!

Combină seturi pentru a-ți extinde joaca!  
Комбинируйте комплекты за по-интригуваща игра!  
Arvieno kompleksus, lai pilnveidotu savas rotaļas!

Kombineeri komplekte, et māngu laiendada!  
Derinkite rinkinius ir išplėskite žaidimą!





Rebuild  
the  
world™





8x  
6468480



2x  
4159553



2x  
6387150



2x  
6265236



2x  
300426



10x  
300326



1x  
4253815



2x  
654126



2x  
370026



4x  
4548180



1x  
302426



1x  
306926



1x  
302326



3x  
4565323



6x  
242026



1x  
302226



3x  
243126



1x  
6168646



1x  
4211389



6x  
403226



2x  
6248496



2x  
6359231



4x  
6252045



2x  
4157103



1x  
6468460



1x  
6121832



4x  
6252040



1x  
4211210



2x  
6092590



1x  
6468462



1x  
4221886

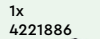

1x  
6307618



1x  
6290983



4x  
4538950



4x  
6000066



1x  
4211398



1x  
4211398



4x  
6320297



6x  
6066097



1x  
4211414



12x  
4211387



2x  
6468461



2x  
4211807



1x  
6216860



1x  
6216862



1x  
6208447



8x  
6000311



2x  
4211103



2x  
4211085



29x  
6126083



2x  
4211001



8x  
4211065



1x  
6350506



1x  
6208447



1x  
6192828



1x  
6470874



1x  
6167464



6x  
4566522



1x  
6469296



1x  
6394966



1x  
6262262



1x  
6394960



1x  
6102984



1x  
6192828



1x  
6093623



1x  
6229024



1x  
6192830



1x  
6431792



1x  
6469294



2x  
6350502



1x  
303426



4x  
6424456



2x  
6251830



2x  
4211067



1x  
303426

 [LEGO.com/service](https://www.LEGO.com/service)



YOU COULD  
**WIN**

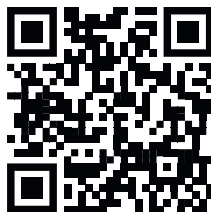

Scan this QR code or go to  
**LEGO.COM/PRODUCTFEEDBACK** and give  
us your short feedback about this LEGO® set  
for a chance to win a cool LEGO prize.

Terms and Conditions apply\*

**EN: YOU COULD WIN.** Terms and Conditions apply\* **DE: Du könntest GEWINNEN.** Es gelten die Teilnahmebedingungen\* **FR: Tu pourrais GAGNER.** Des conditions s'appliquent\* **IT: Potresti VINCERE tu.** Termini e condizioni sono applicabili\* **ES: Puedes GANAR.** Aplican términos y condiciones\* **PT: Poderá GANHAR.** Aplicam-se termos e condições\* **ZH: 轻松获奖. 条款和条件适用\*** **PL: Szansa na WYGRANĄ.** Obowiązują warunki korzystania\* **CS: Máte šanci VYHRÁT.** Platí všeobecné smluvní podmínky\* **SK: Máte šancu VYHRÁŤ.** Platia všeobecné zmluvné podmienky\* **HU: TE IS NYERHETSZ.** Felhasználási feltételek érvényesek\* **RO: Ai putea CÂȘTIGA.** Se aplică termenii și condiții\* **BG: Можете да СПЕЧЕЛИТЕ.** Има определени правила и условия\* **LV: Tu vari LAIMĒT.** Ir spēkā noteikumi un nosacījumi.\* **ET: Sul on võimalus VÕITA.** Kehtivad tingimused\* **LT: Jūs galite LAIMĖTI.** Taikomos sąlygos\*

\*[LEGO.com/productfeedback-terms](https://www.lego.com/productfeedback-terms)

LEGO and the LEGO logo are trademarks of the LEGO Group. ©2024 The LEGO Group.

© 2024 Mojang AB. All Rights Reserved. Minecraft, the Minecraft logo, the Mojang Studios logo and the Creeper logo are trademarks of the Microsoft group of companies.

6501786