



# DREAMZZZ

71481



Q LEGO® Builder



LEGO.com/sustainable-packaging



 **FR**  
**DONNEZ**  
OU  
**RECYCLEZ**

 OU  OU 

ASSOCIATION MAGASIN DÉCHÈTERIE

Adresses sur [quefairedemesdechets.fr](http://quefairedemesdechets.fr)

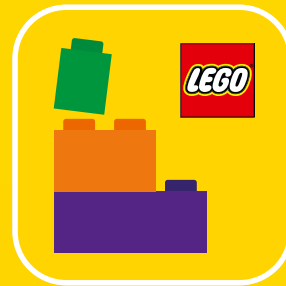

# BUILDER



Apple and the Apple logo are trademarks of Apple Inc., registered in the U.S. and other countries and regions. App Store is a service mark of Apple Inc. Google Play and the Google Play logo are trademarks of Google LLC. Tencent and the Tencent logo are trademarks of Tencent Inc.



**EN** Ask parents' permission before going online | **DE** Eltern um Erlaubnis bitten, bevor du online gehst | **FR** Demande l'autorisation d'un parent avant d'aller en ligne | **IT** Chiedi il permesso ai tuoi genitori prima di andare online | **ES** Pídeles permiso a tus papás antes de conectarte a Internet | **PT** Pede autorização aos pais antes de acederes online | **ZH** 上网前应先征得父母的同意 | **PL** Poproś rodziców o zgodę, zanim wejdiesz do Internetu | **CS** Než půjdeš na internet, požádej rodiče o svolení | **SK** Skôr než pôjdeš na internet, vypýtaj si povolenie od rodičov | **HU** Kérj szülői engedélyt, mielőtt online csatlakoznál! | **RO** Cere permisiunea părinților înainte de a te conecta online | **BG** Поискайте разрешение от родител, преди да влезете онлайн | **LV** Pirms došanās tiešsaistē palūdz atļauju vecākiem | **ET** Enne Interneti kasutamist küsi vanematelt luba | **LT** Prieš prisijungdami prie interneto, atsklauskite tėvų







1x



1x



1x

1





1x



1x

2





3







		
2x	1x	2x
		
1x	1x	1x

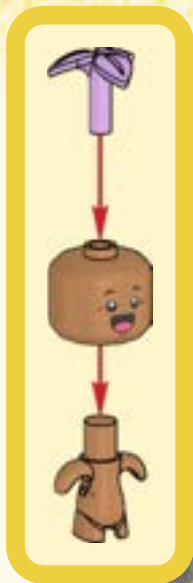





1

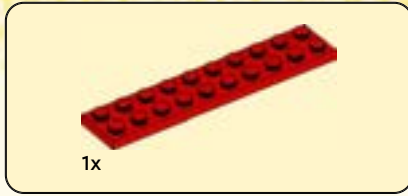

2



3





4

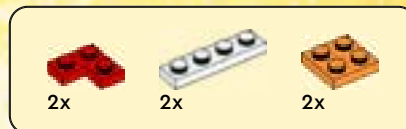

5





1x

6



2x

7

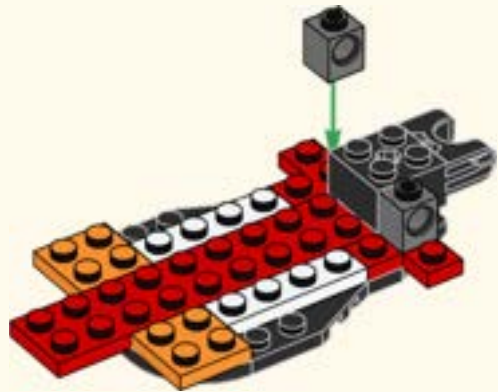



3x

8



2x



1x

9





4x

10



1x



1x

11







2x

12

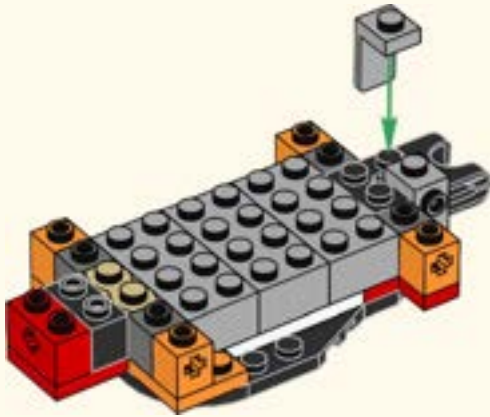

1x



2x

13

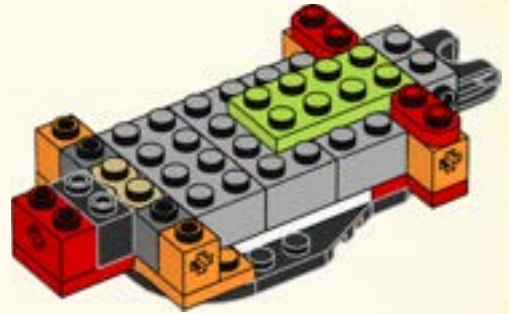



2x

14



1x



1x



2x

15

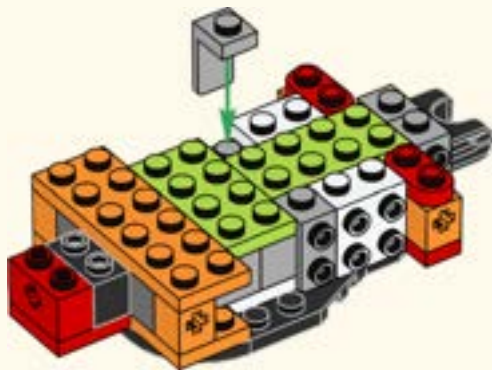



2x

16

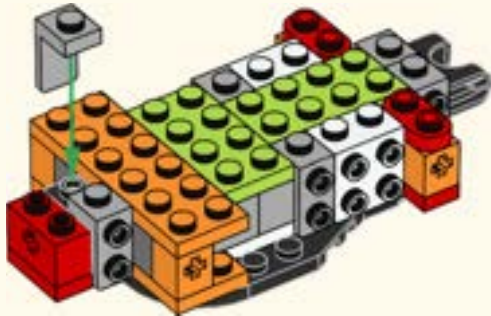

1x

17

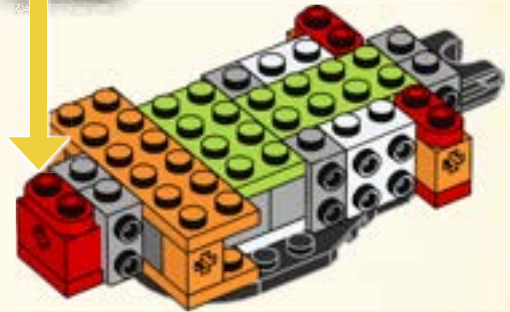



2x



2x

18

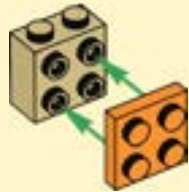

2x

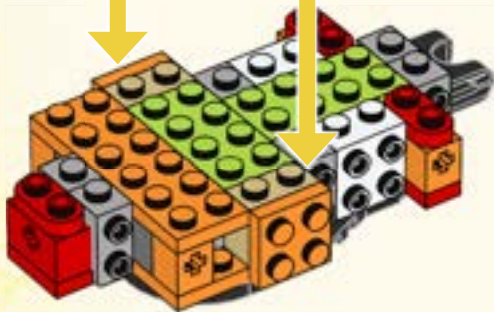

2x



2x

19



2x

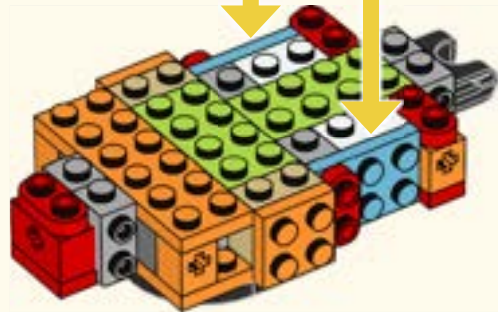

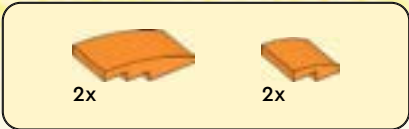

20

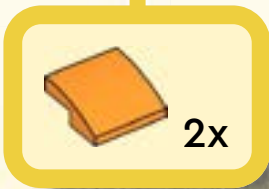
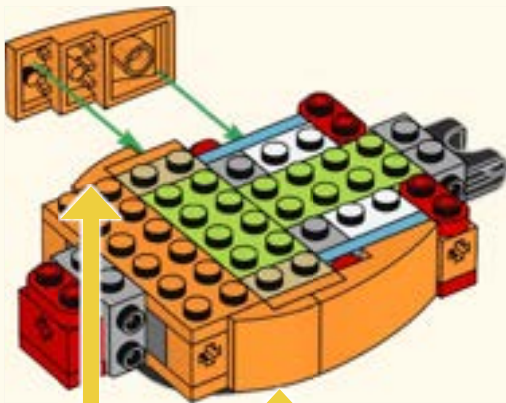

21

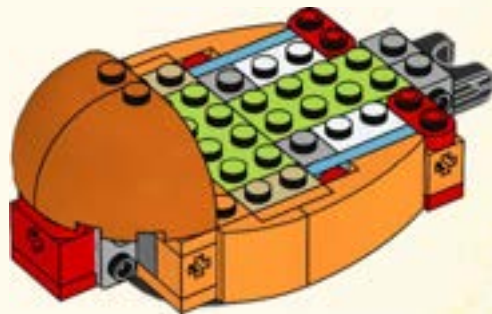



# 22

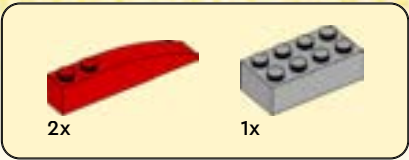
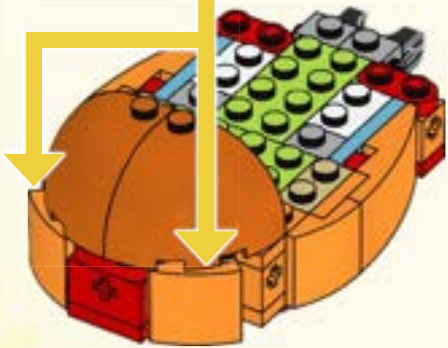
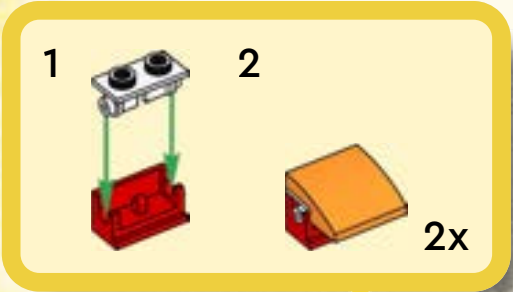

# 23

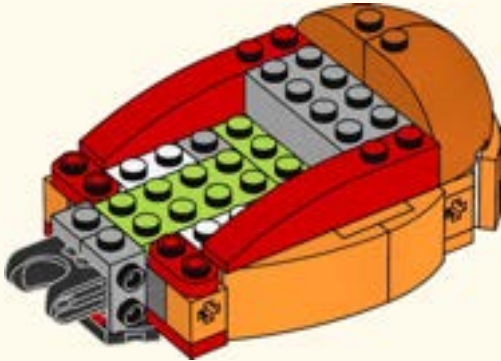



1x

24

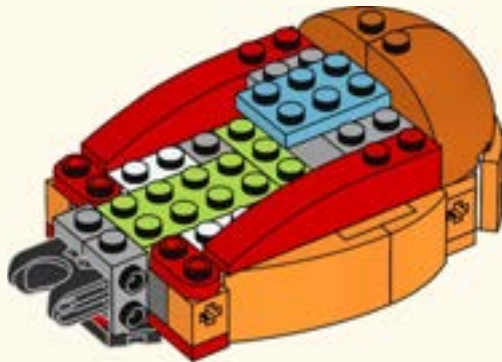

2x

25

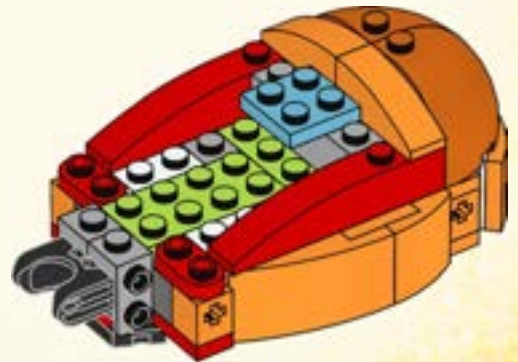



26

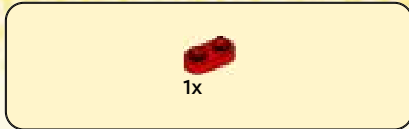
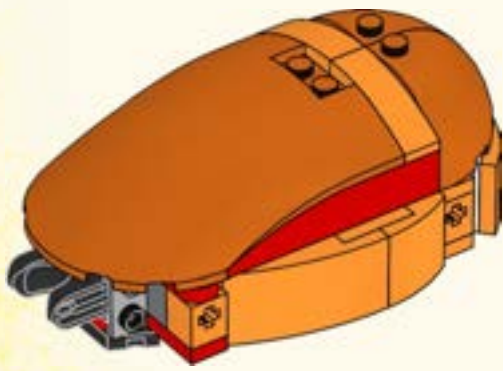

27

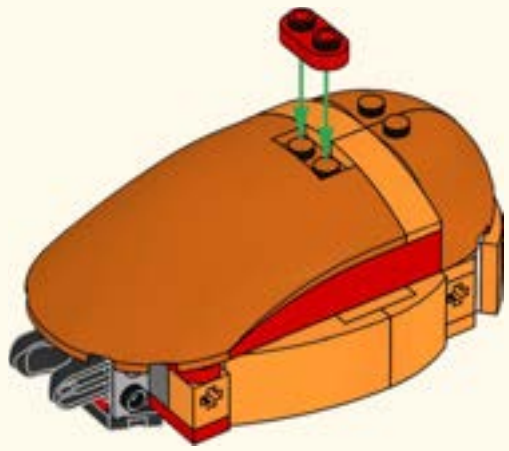



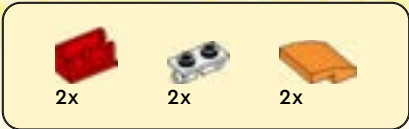

28

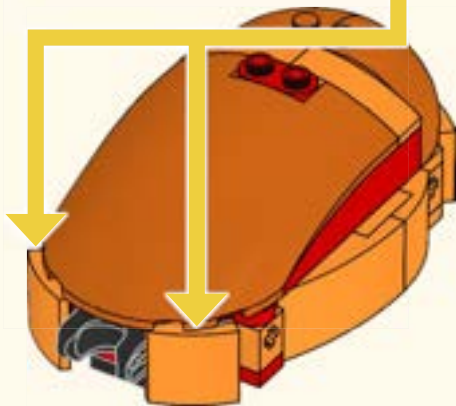
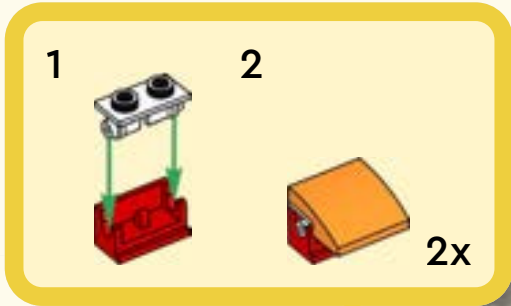

29

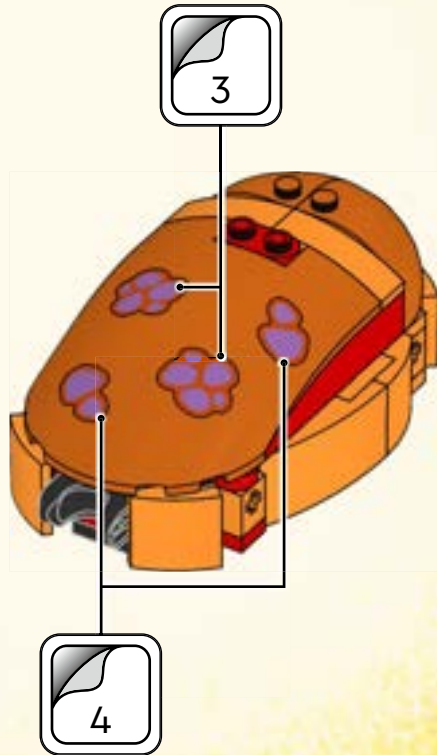





1x



1x

1



1x



1x



1x

2





3





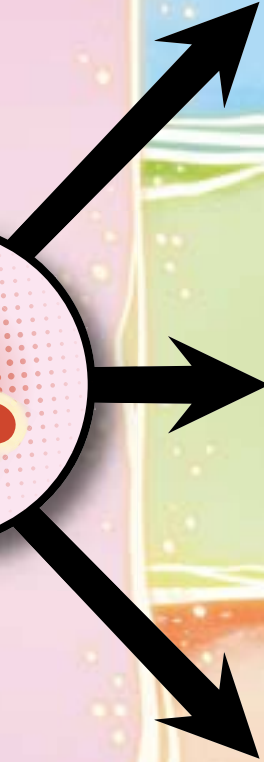





2x 2x 3 2x

30

3 1:1

1 2 2x

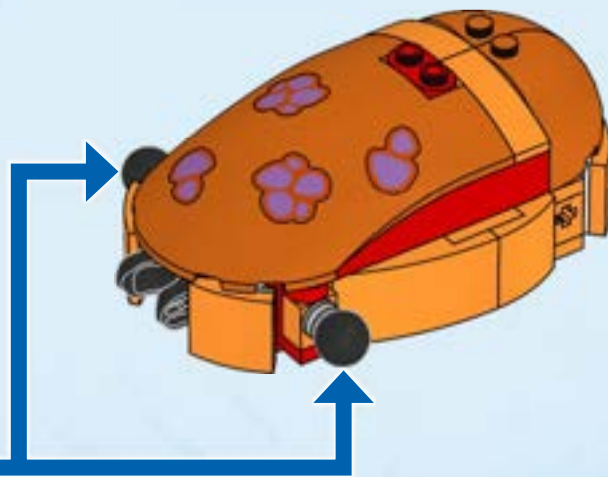





31

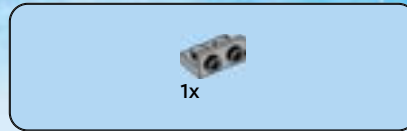
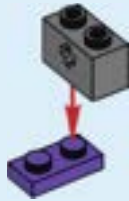

32

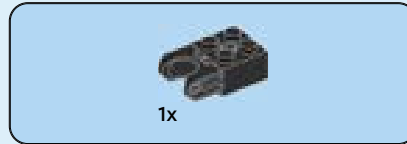

33





34



35



36

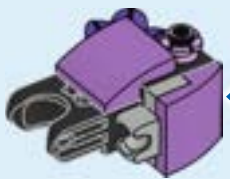
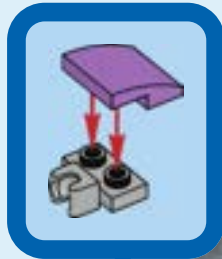

37

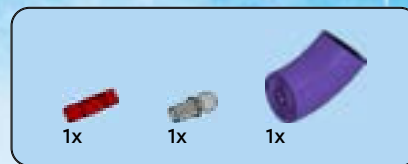
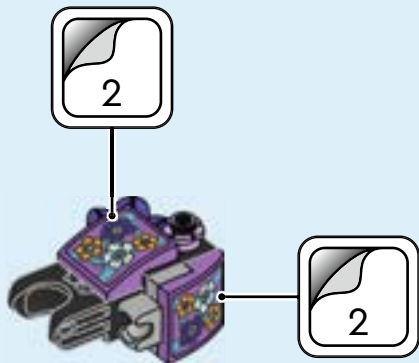

38

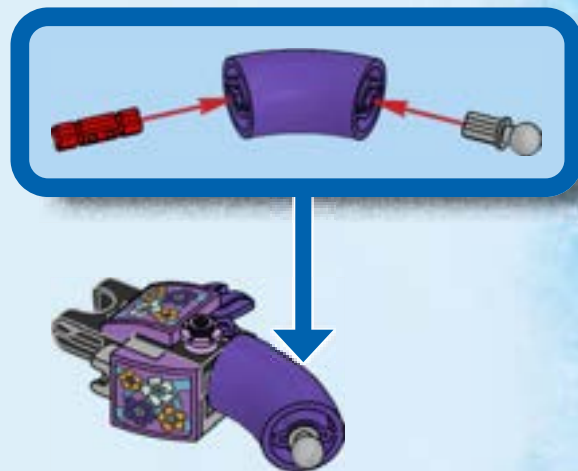



39

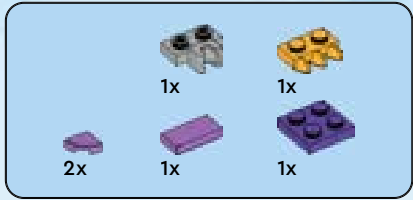
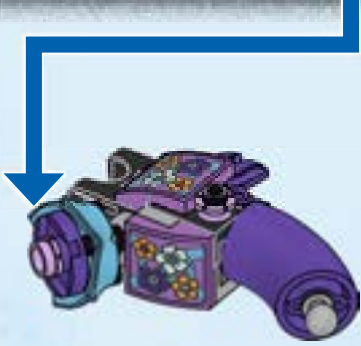
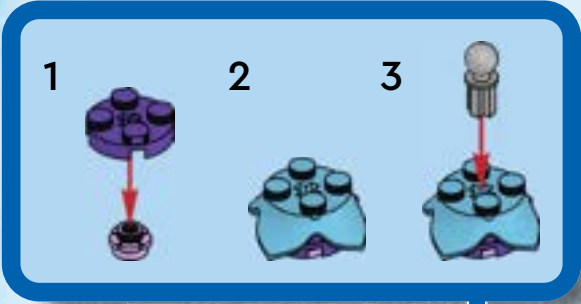

40

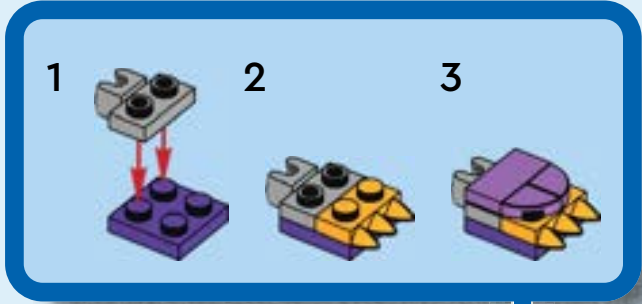

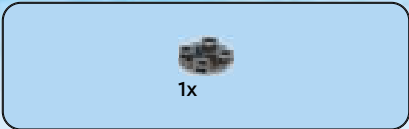

41

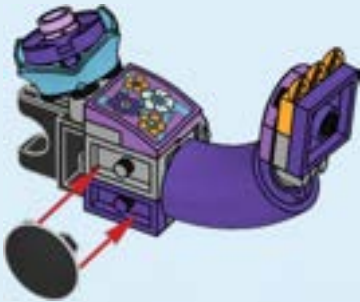

42

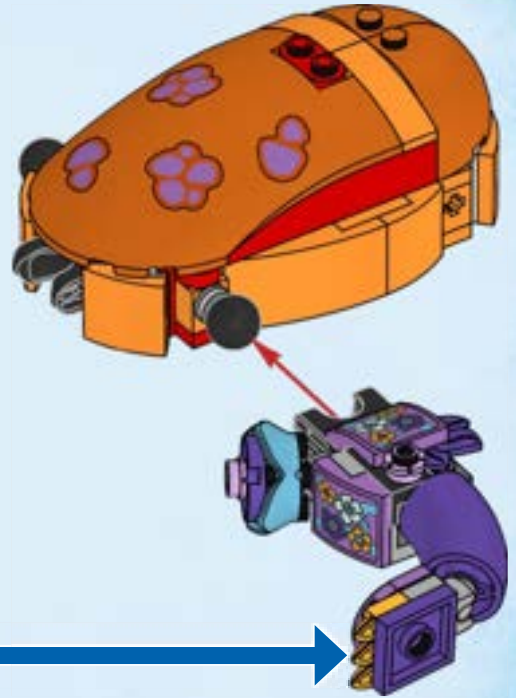



43

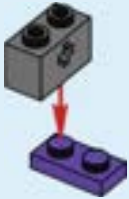

44



45





1x



1x

46



1x



1x

47



1x



1x

48

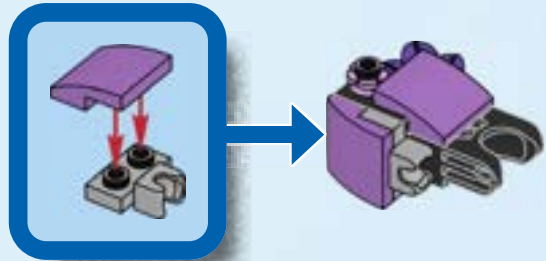

49

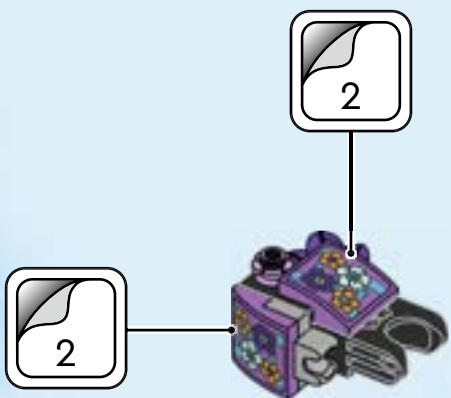

50

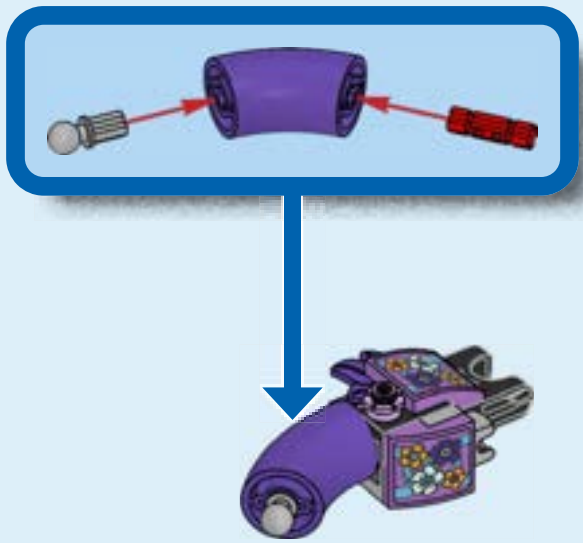





51



52

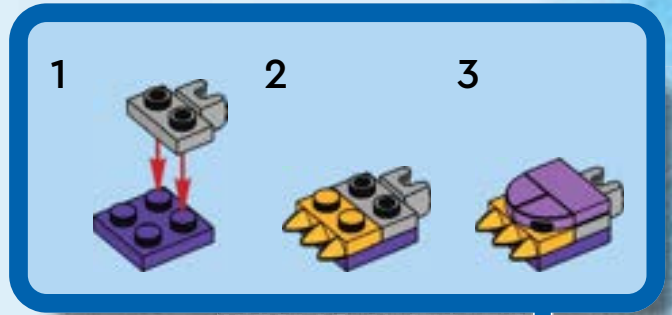



1x

53

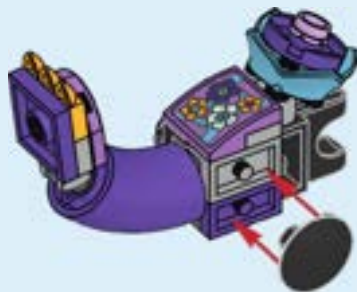
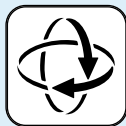

54

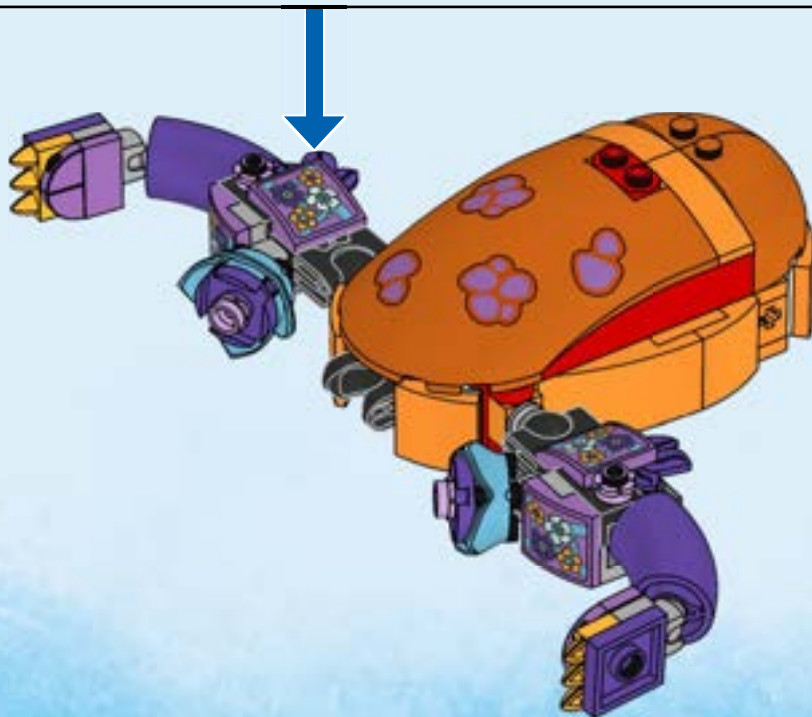

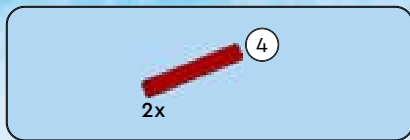

55

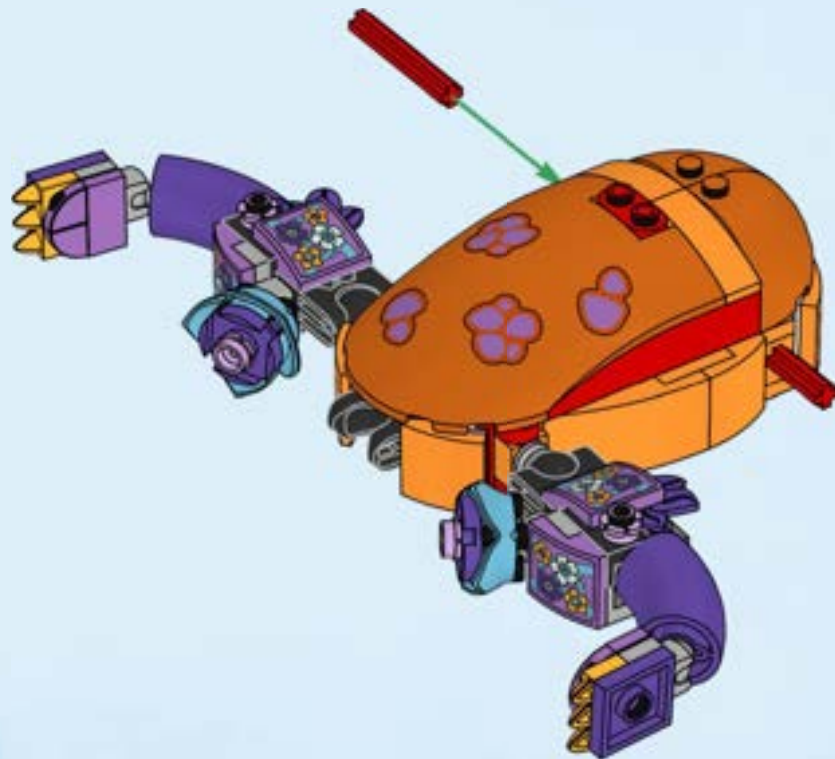

56

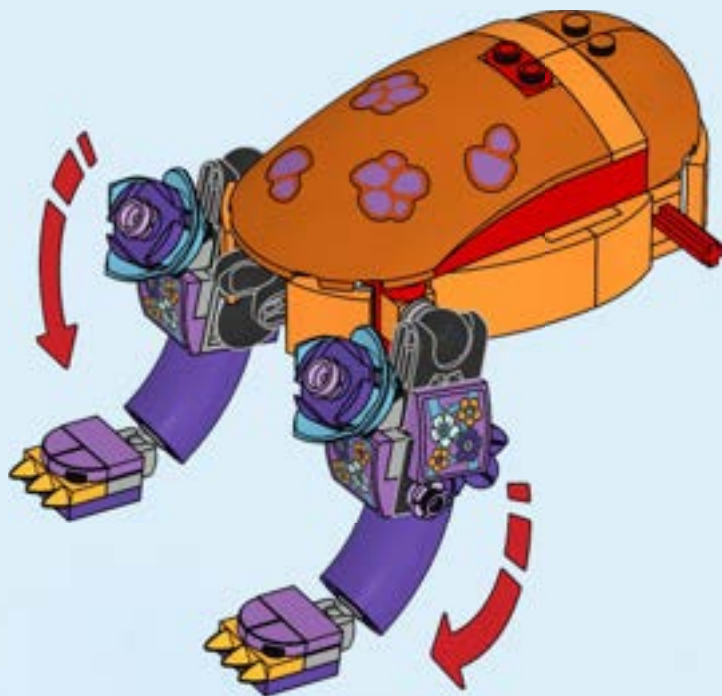



2x



1x



1x

57

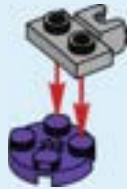

1x

58



1x

59



2x

60



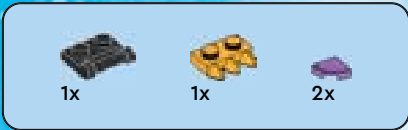

61

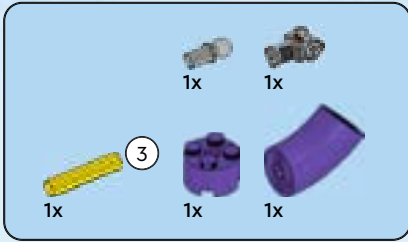
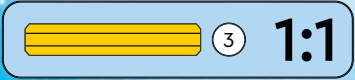
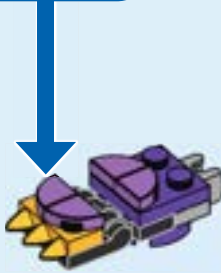

62

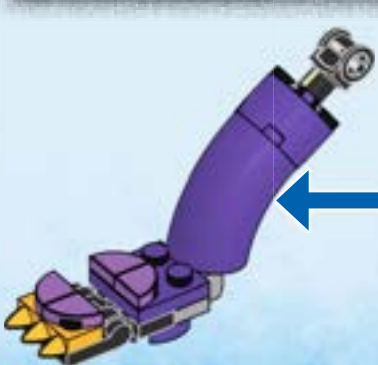
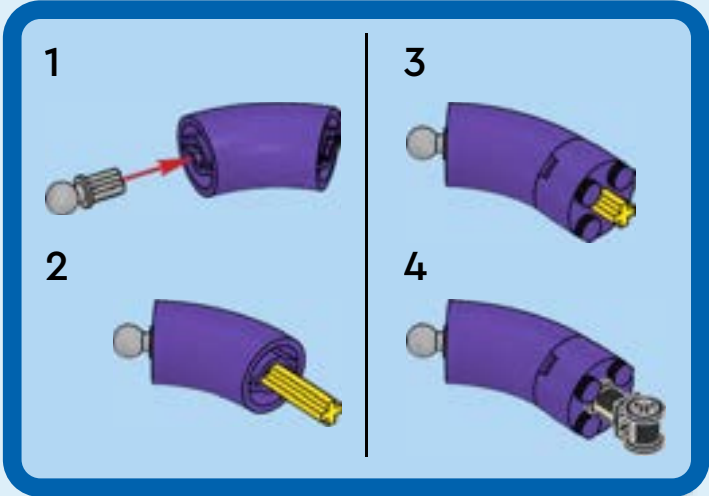

2x

63

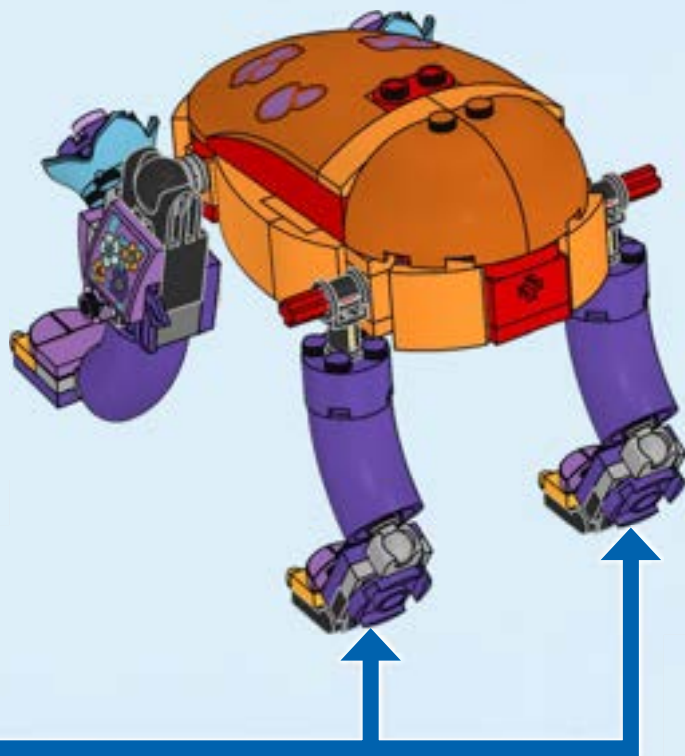



4x



2x



8x

# 64



2x

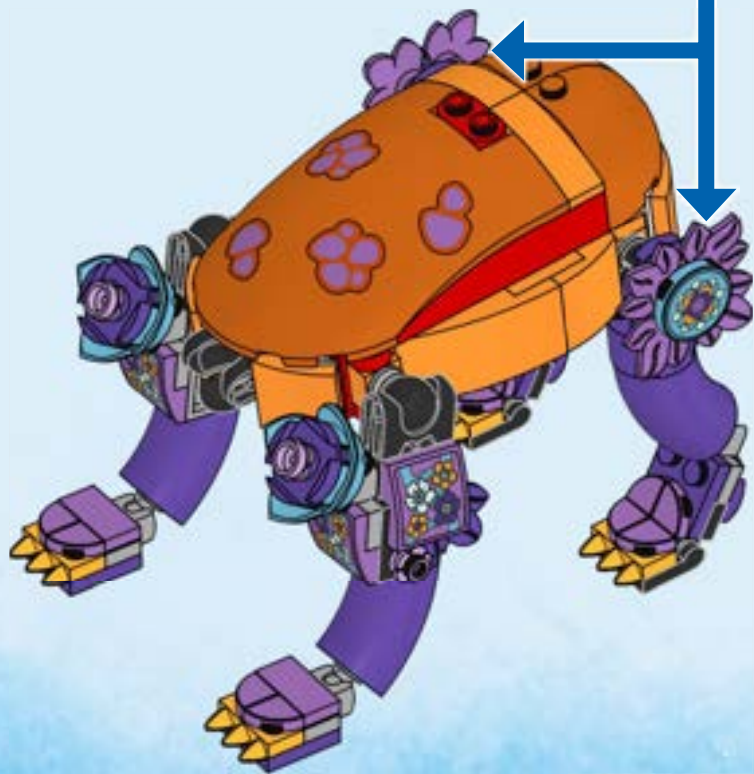





65



66

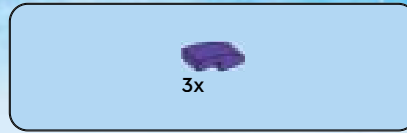

67



68



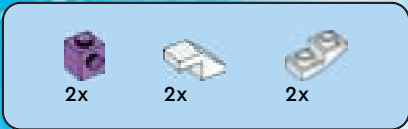

69

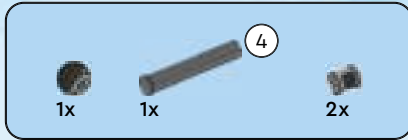
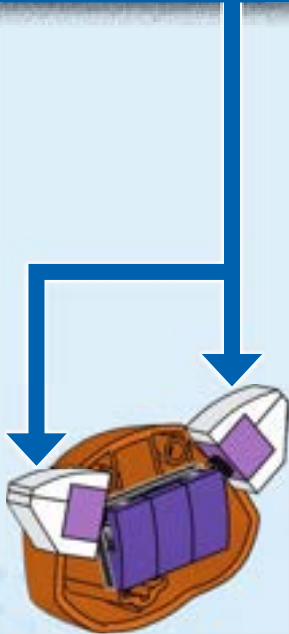
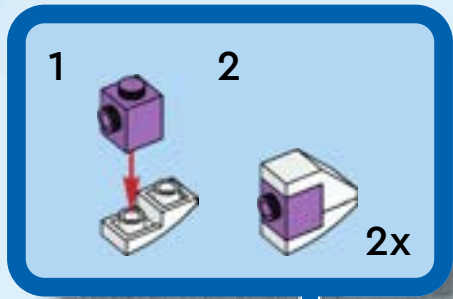

70

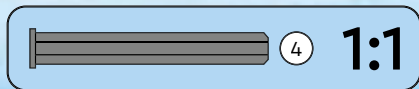
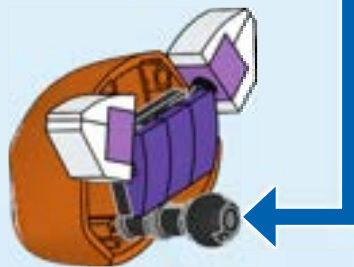
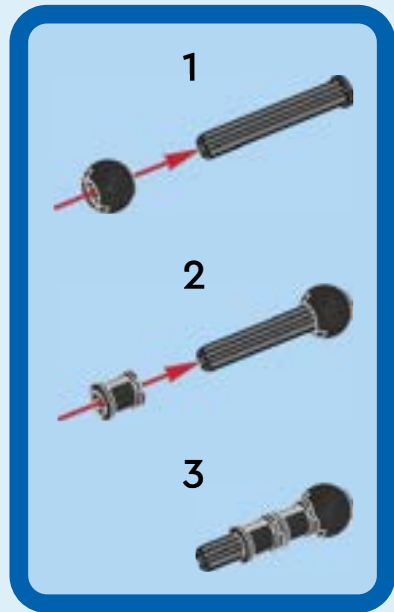

71

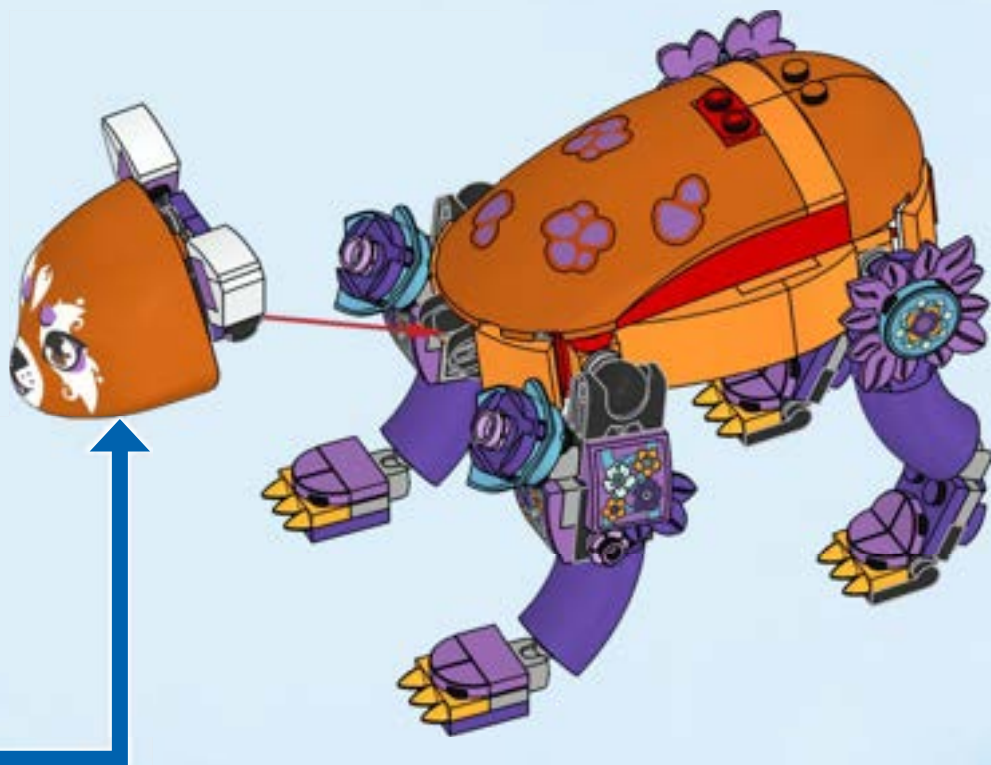



72

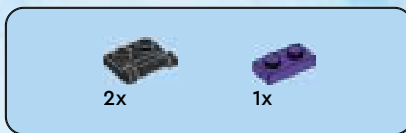

73

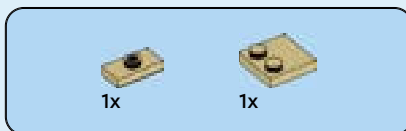

74





# 75





# 76

1 2 3 4

1. A purple 1x2 Technic brick with two holes is being placed onto a grey 1x2 Technic brick with two holes. Red arrows point downwards from the purple brick to the grey brick.

2. A brown 1x2 Technic brick with a hole is being placed onto the purple 1x2 Technic brick from step 1. A red arrow points upwards from the brown brick to the purple brick.

3. The assembly from step 2 is shown from a different angle, showing the brown brick is now attached to the purple brick.

4. A rotation icon (a square with a circle and four arrows) is shown above the final assembly from step 3, indicating that the assembly should be rotated.



77

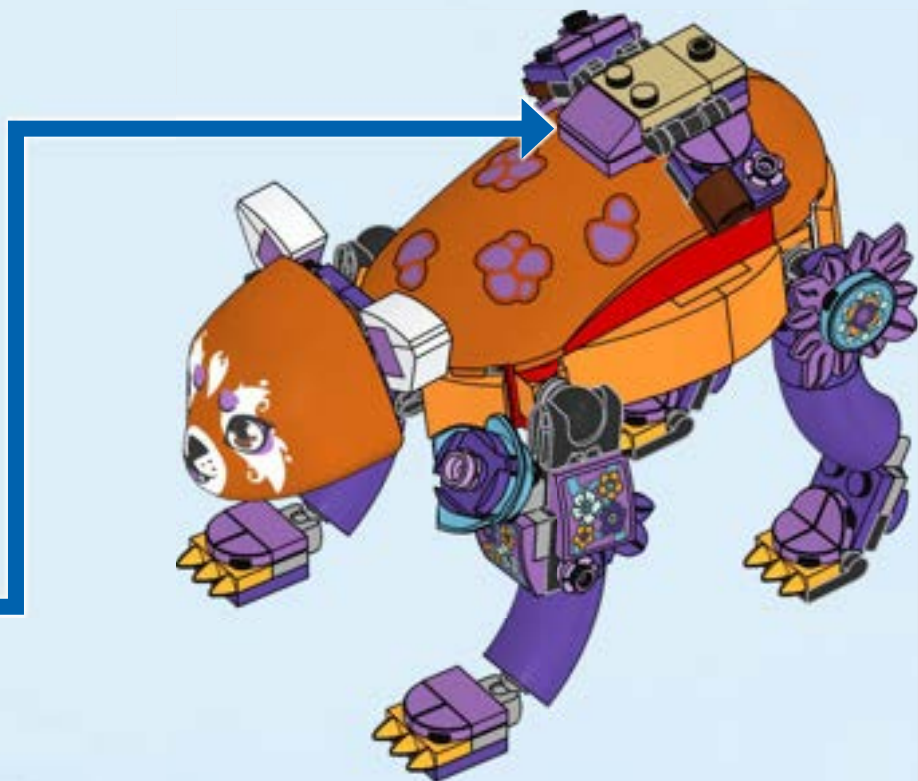

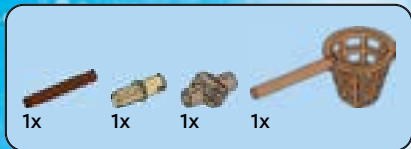

78

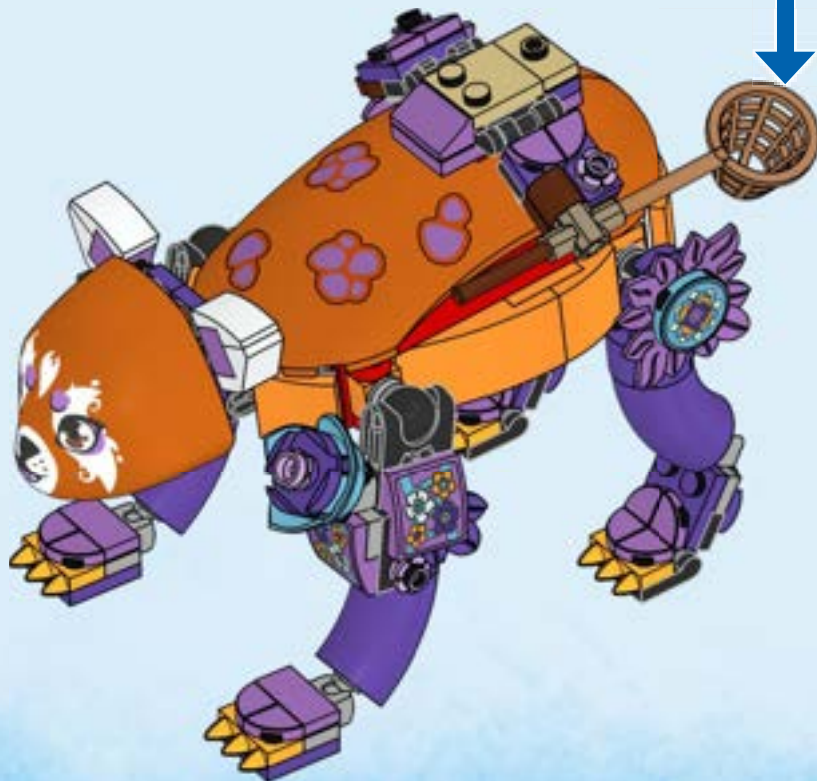
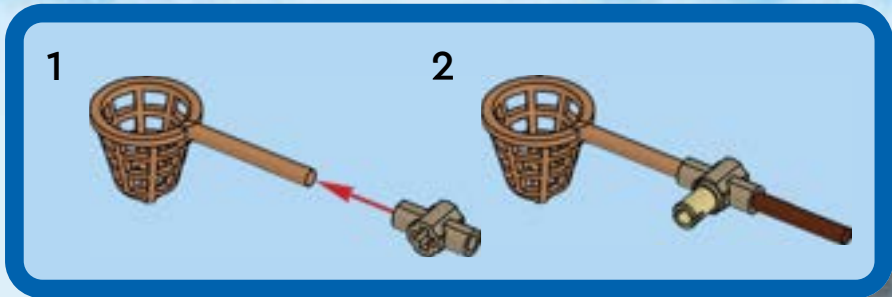



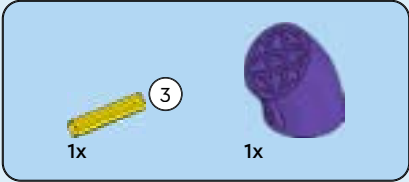
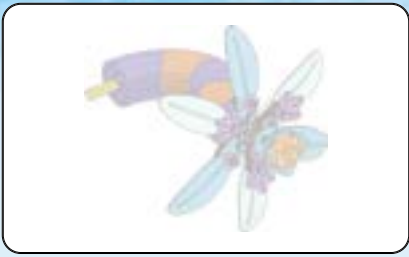

79

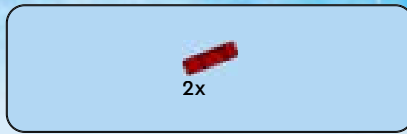
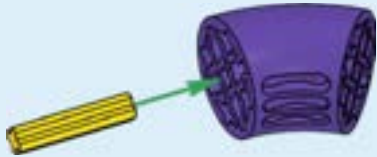

80

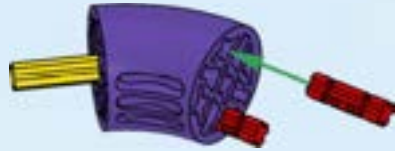

81

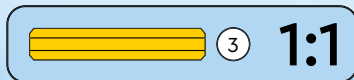



82

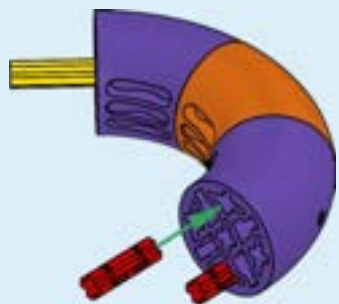

83

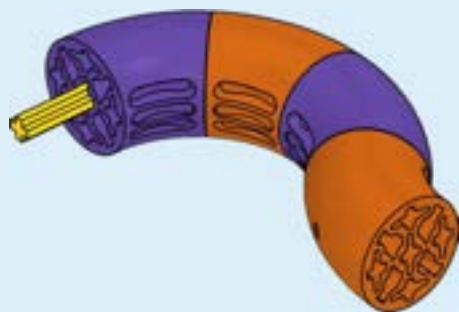

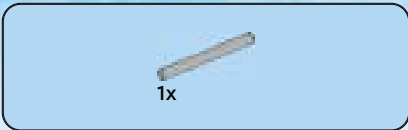

84

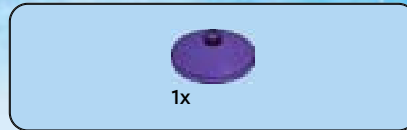
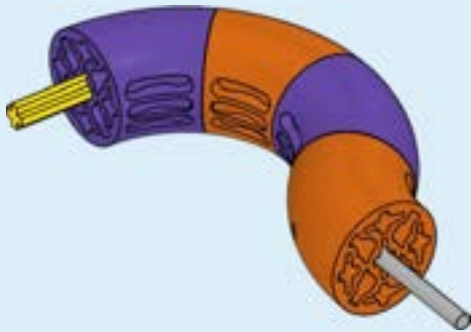

85





86

1



2

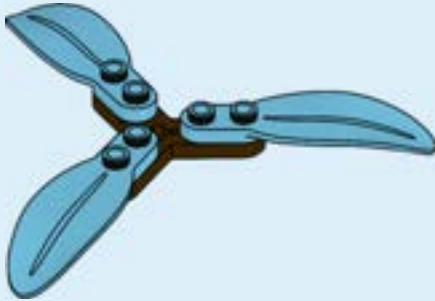

3

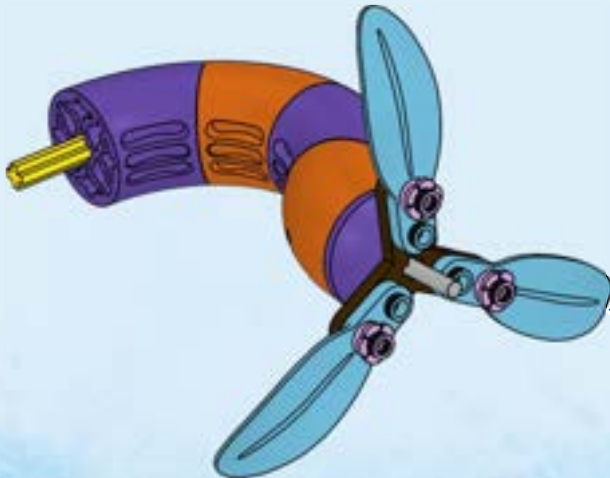
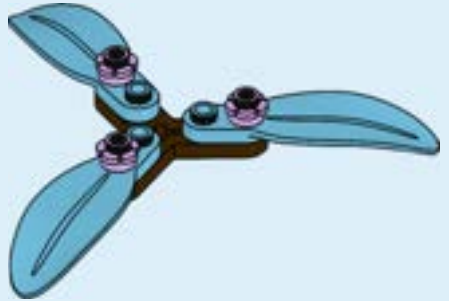

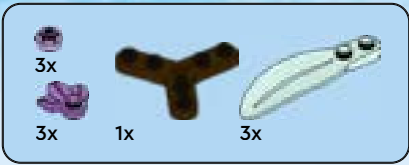

87

1



2



3

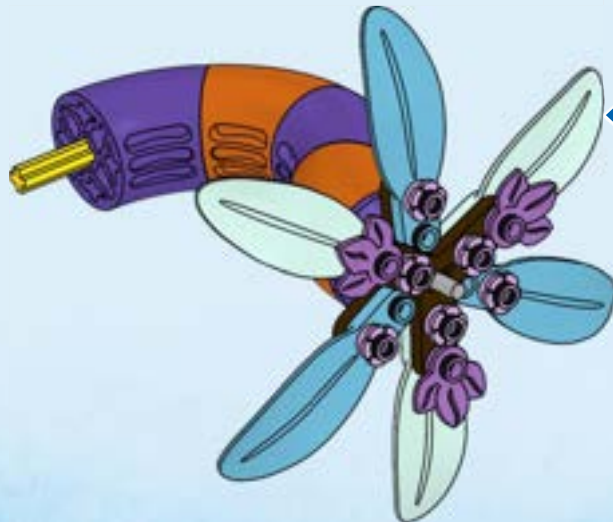
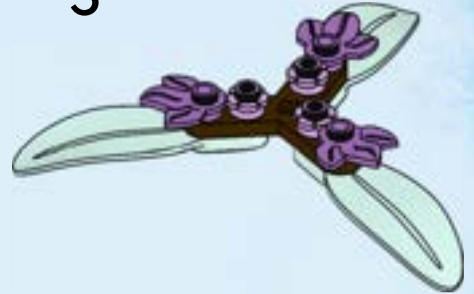

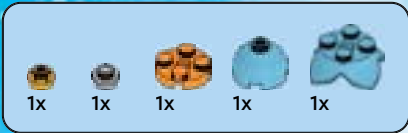

88

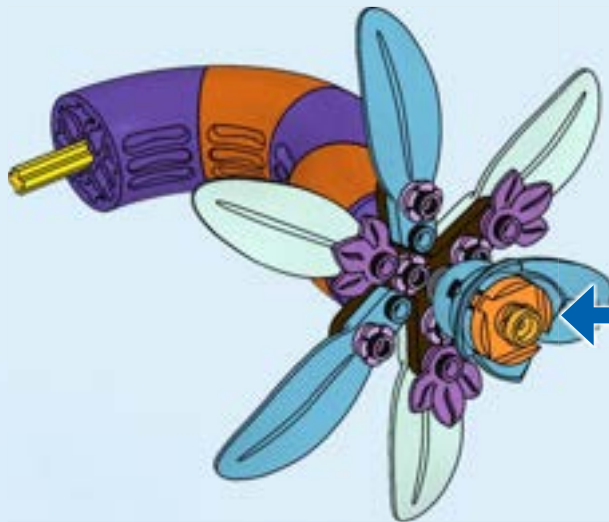

89

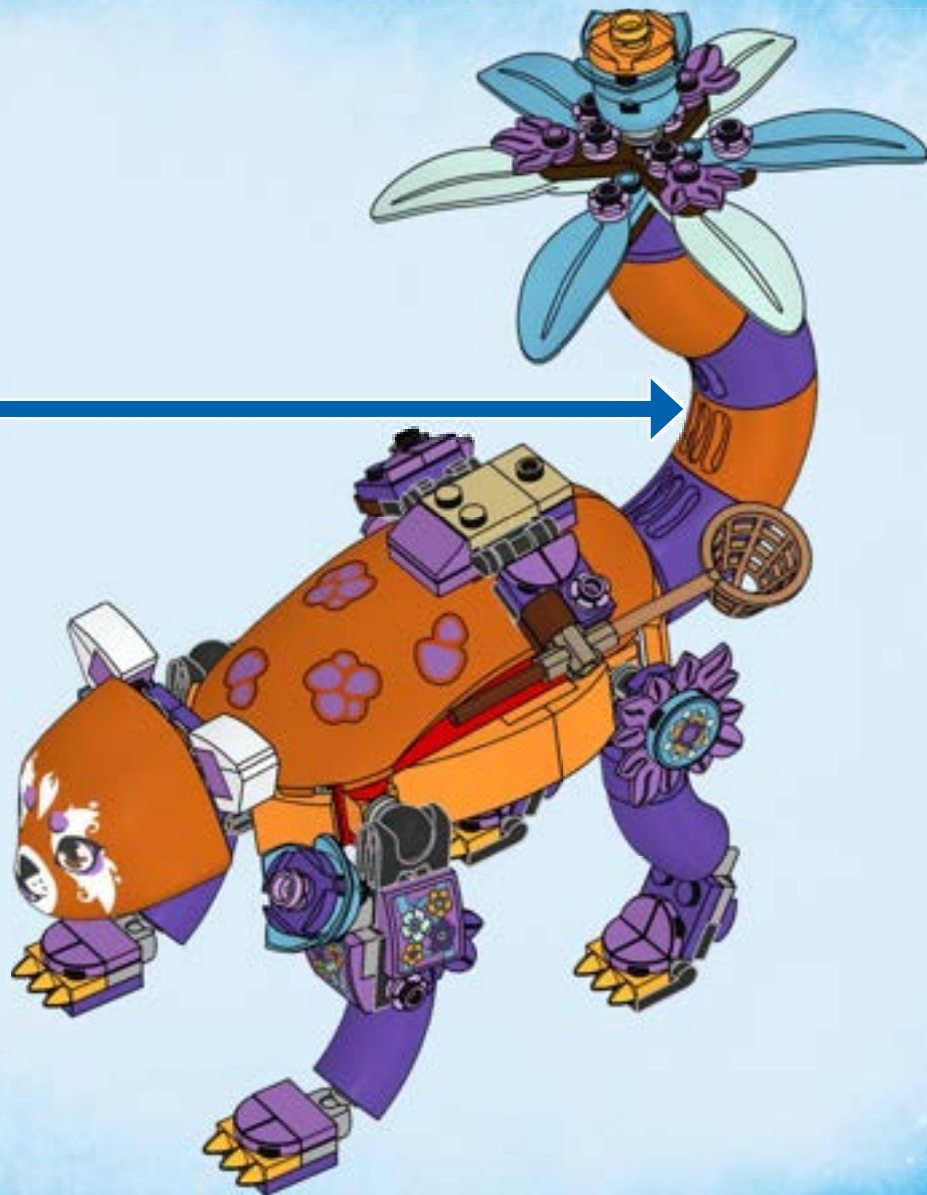





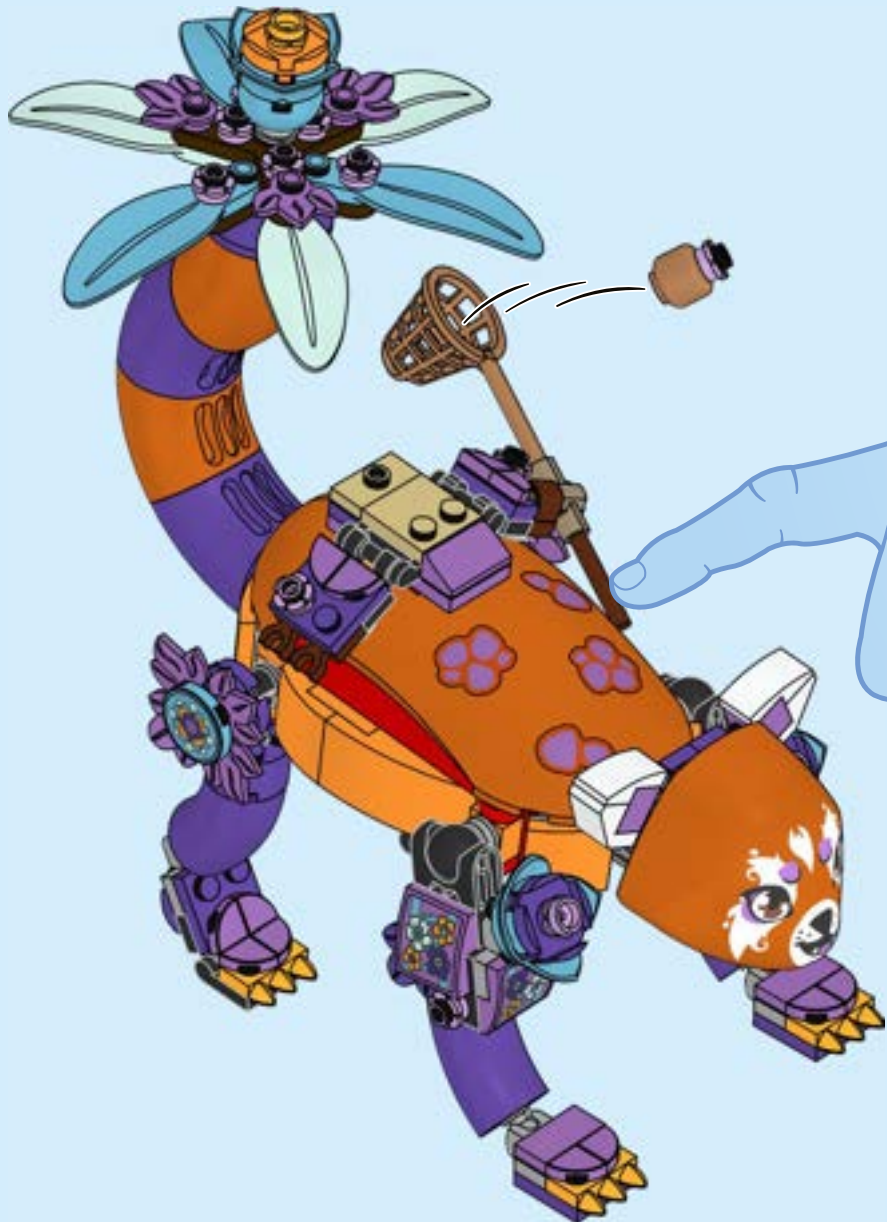



1



2



3



4



1



2



3



4







+





30





1x



1x

31

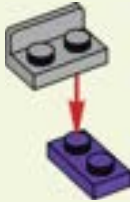

1x

32



1x

33



2x

34

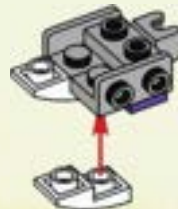



1x

35



2x

36



2x

37



1x



1x

38





1x



1x

39



1x

40



2x

41



2x

42







43



44

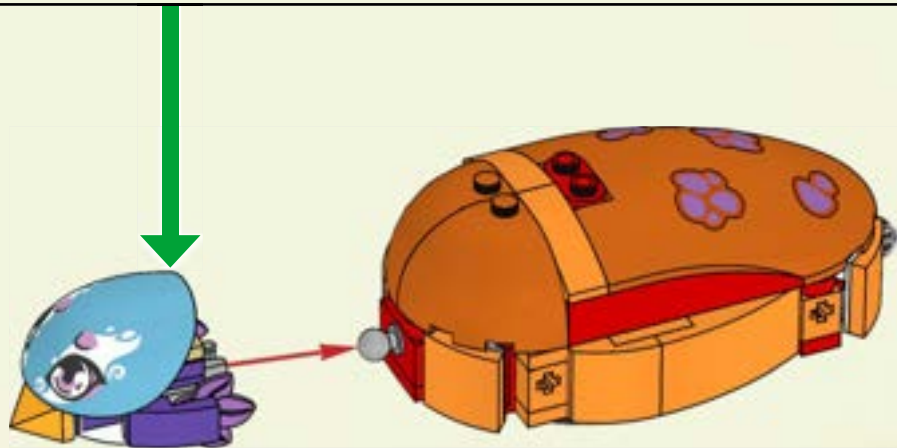



2x

45



2x

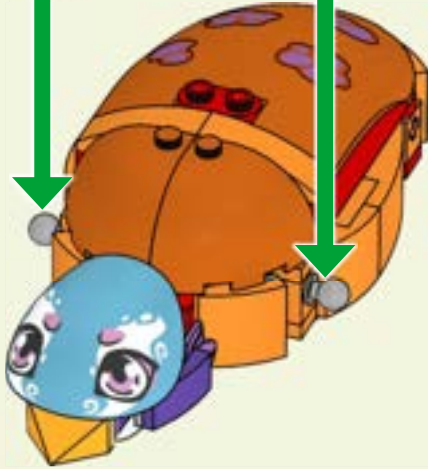



46



47



48

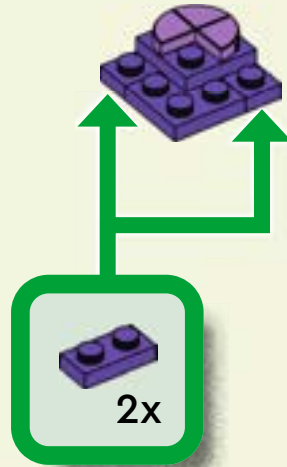



2x

49

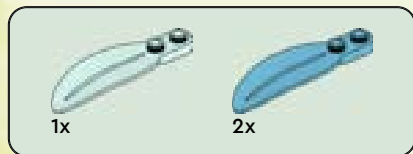

50



1x

51



52



53



54





1x

55



1x



1x

56



1x

57



58

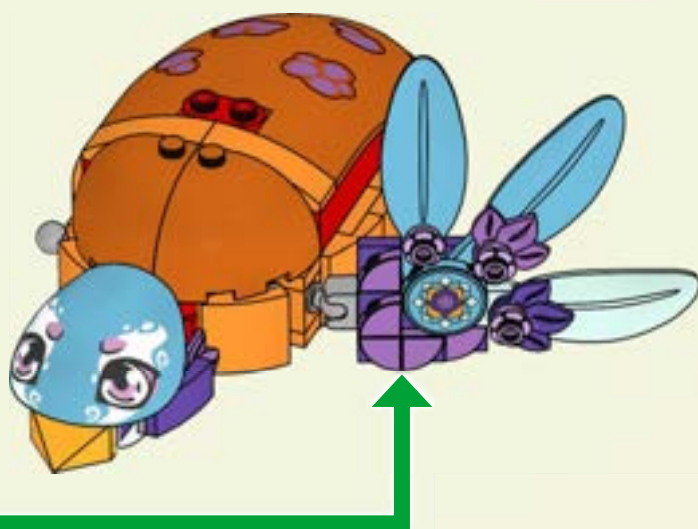



59



60



61

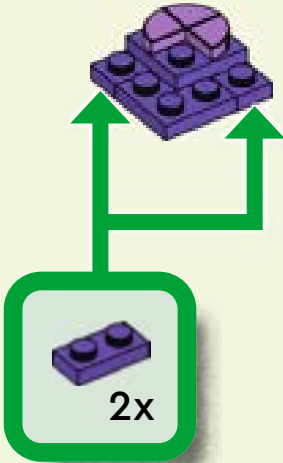





2x

62



1x



2x

63



1x

64



65



66

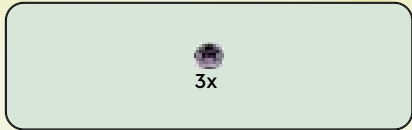

67



1x

68

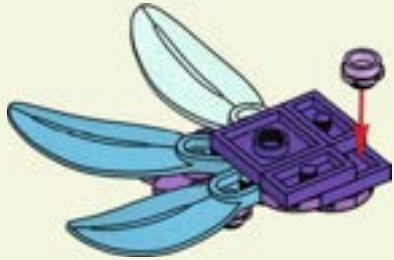

1x

1x

69



1x

70



71

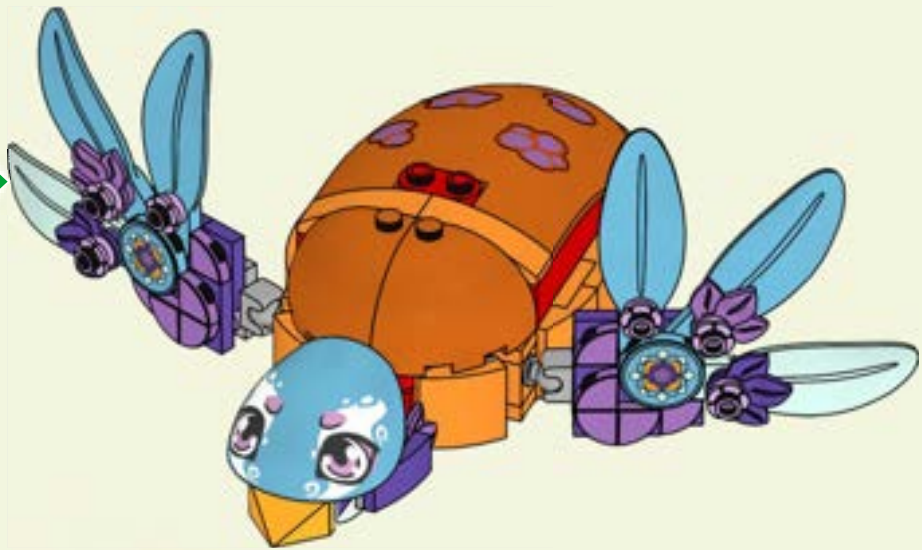



72

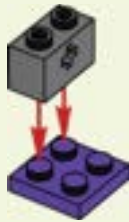

73



74





1x

75



76



1x



1x

77



78

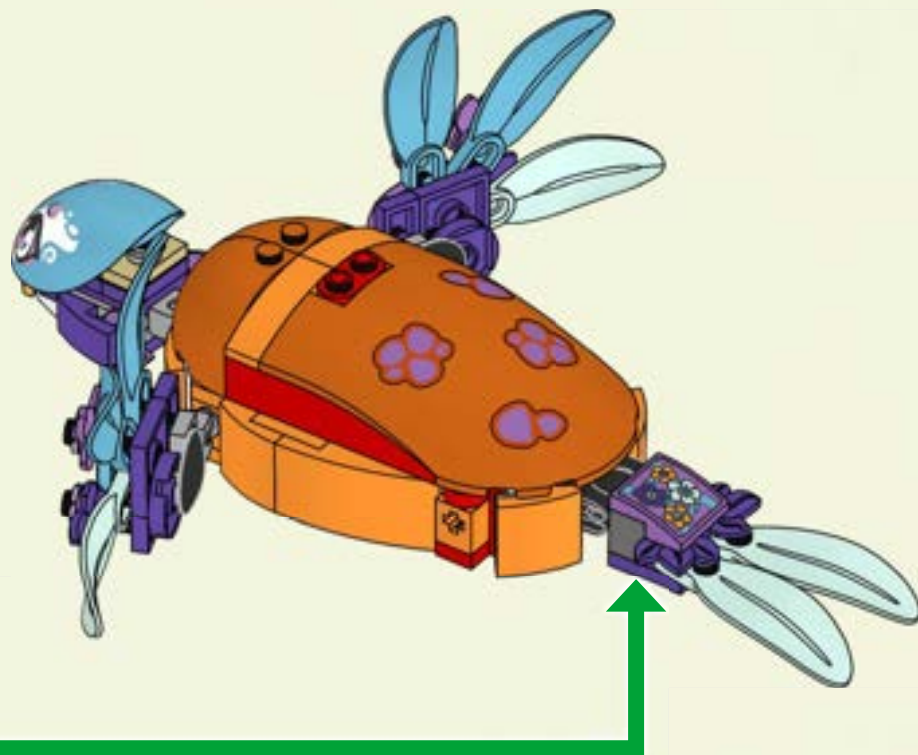

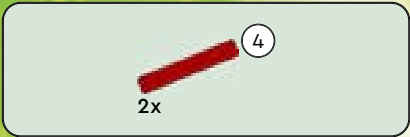

79

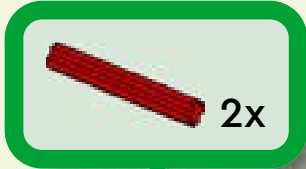
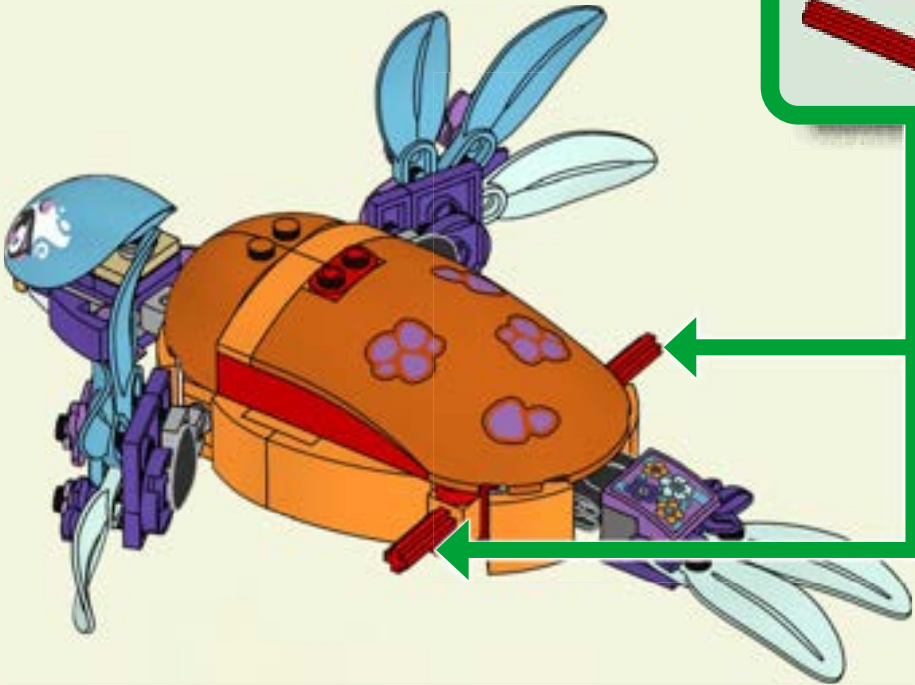





2x



1x



1x

80

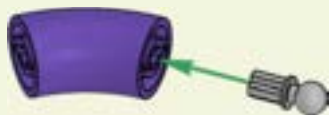

4

1:1

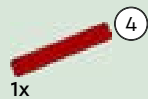

1x

81



1x

82

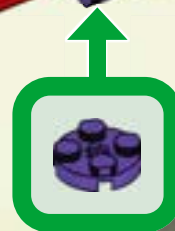
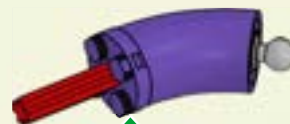



2x

83

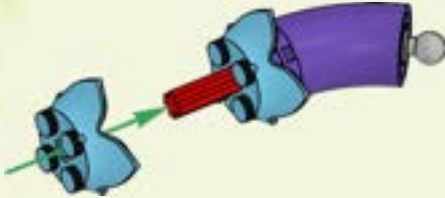

1x

84



1x



1x



1x



1x



1x

85

1

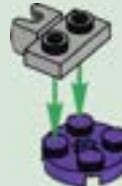

2



3



4



2x

86

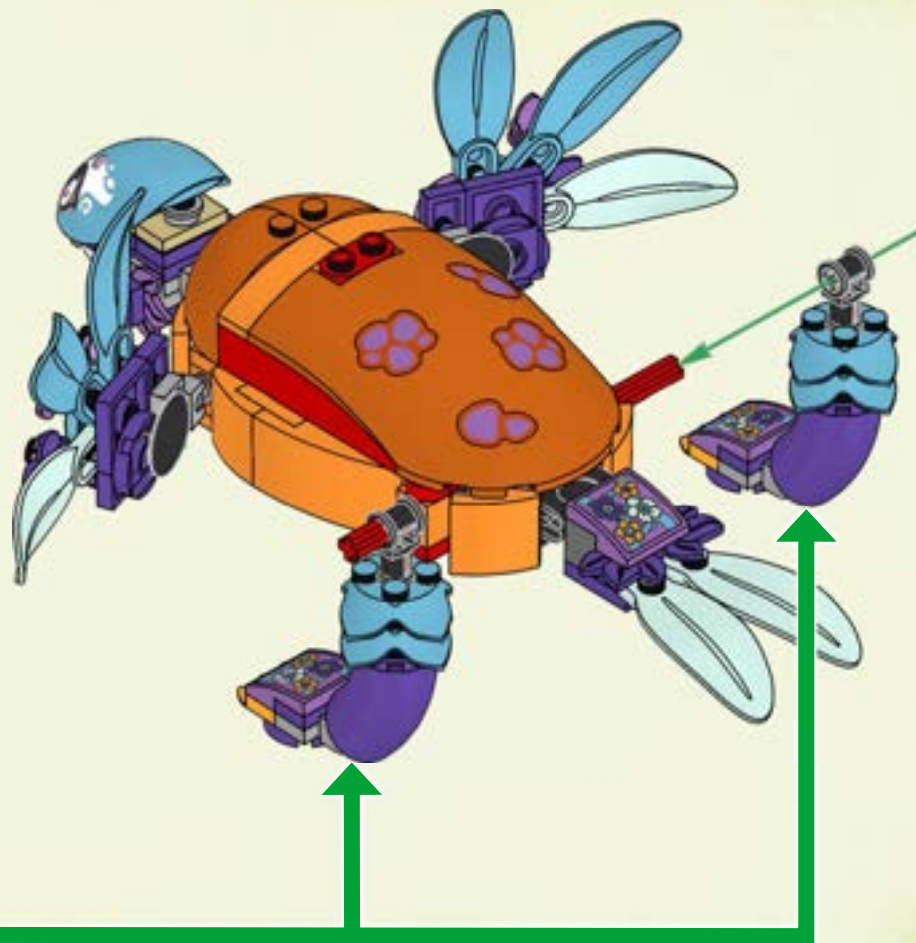

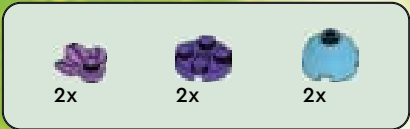

87

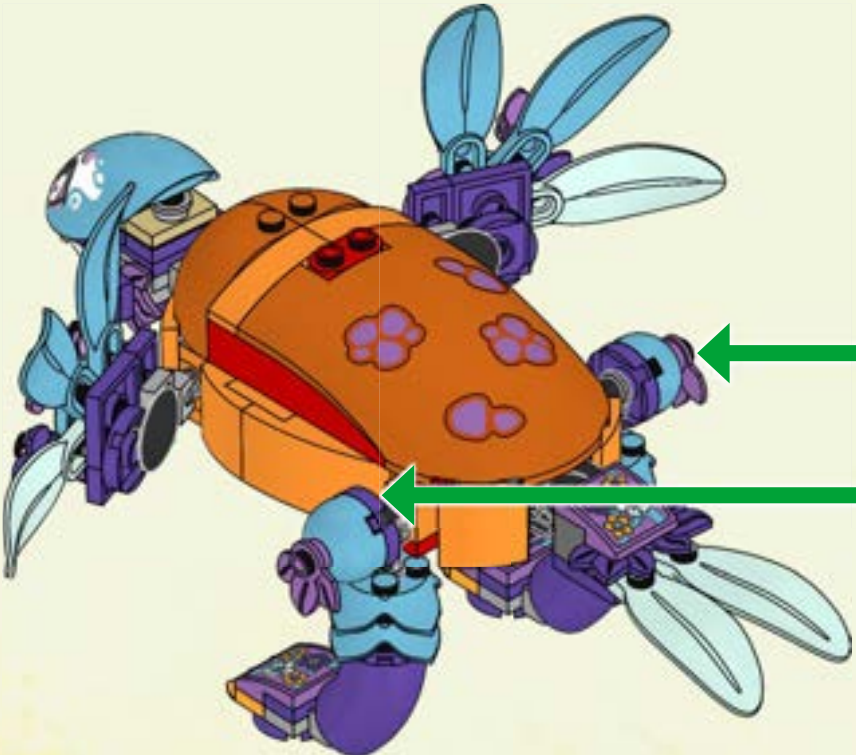
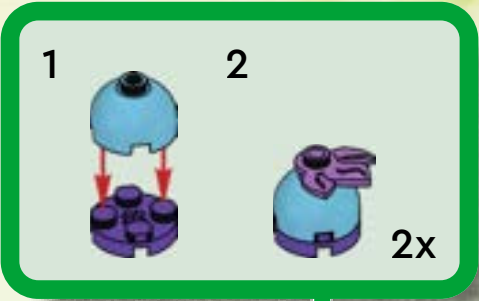

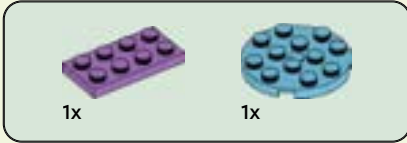

88

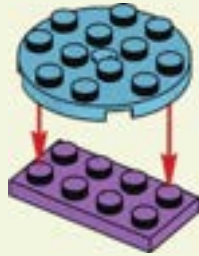

89



90

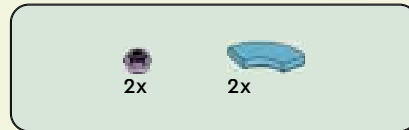

91





92

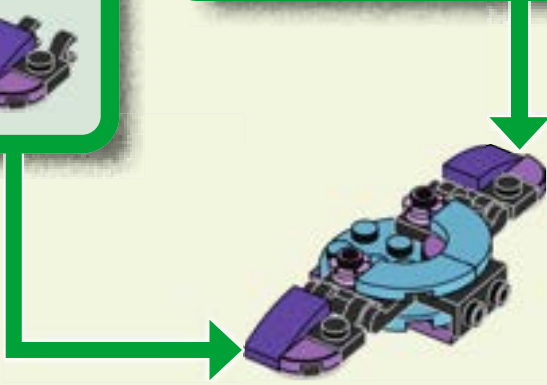
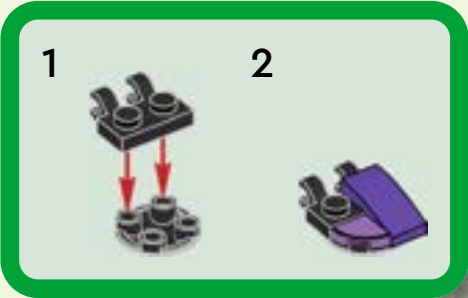
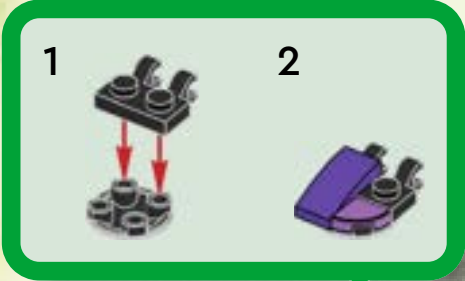

2x



2x

93



2x

94

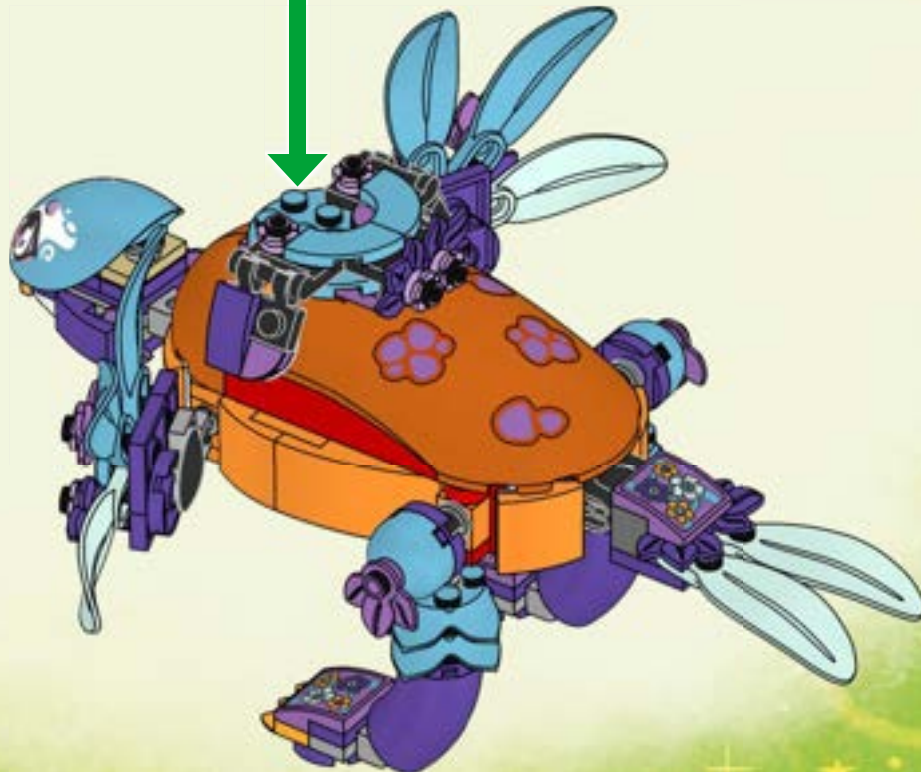



1

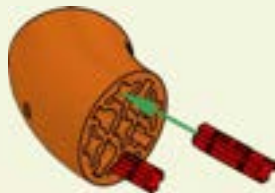

2

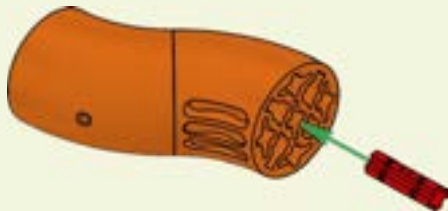





3

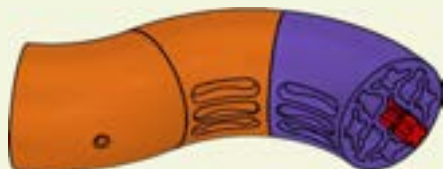

4

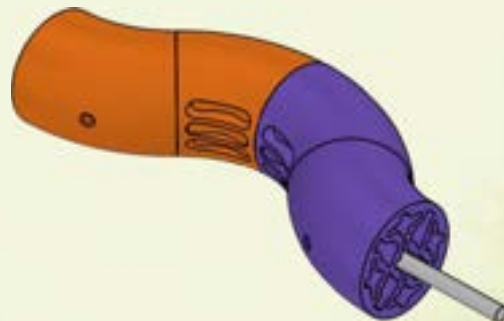



5

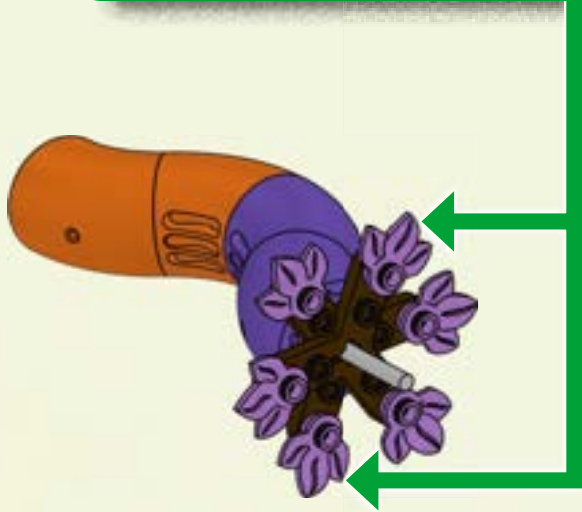
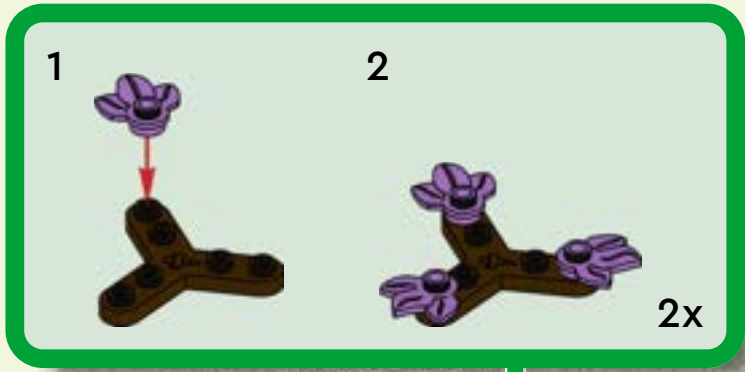



6



7

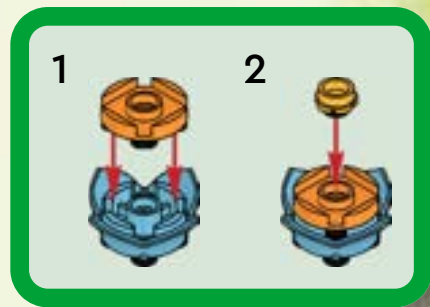

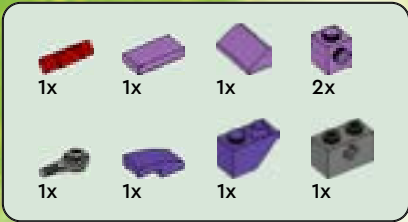

8

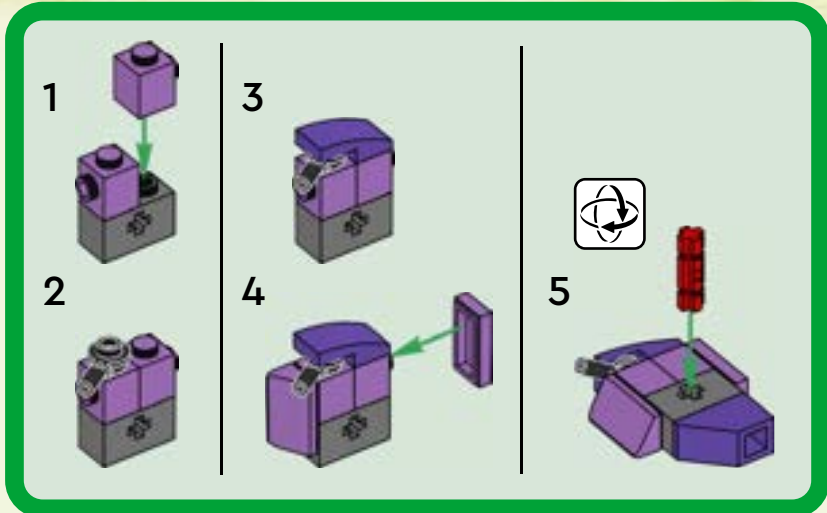



9

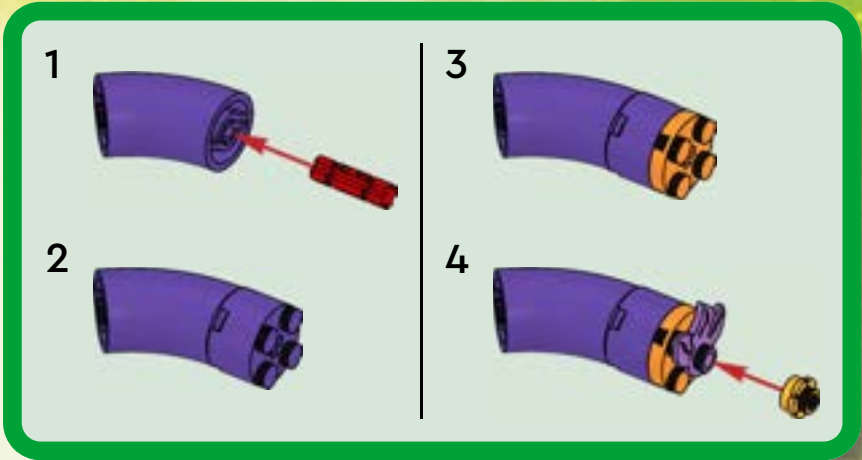



1

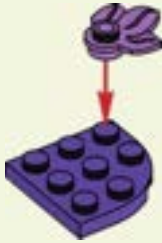

2



3



4





1x



1x

5



1x

6



1x



1x

7

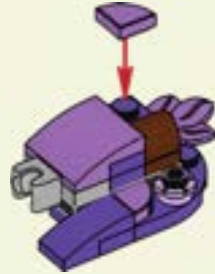

8





9

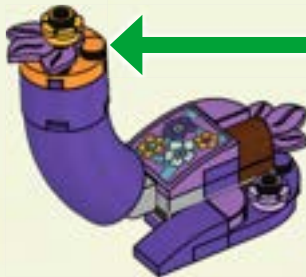
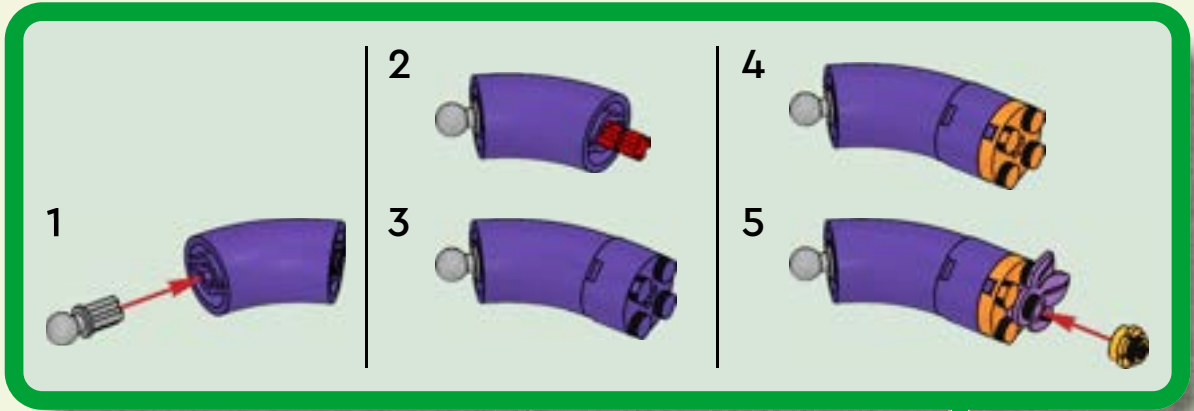





10

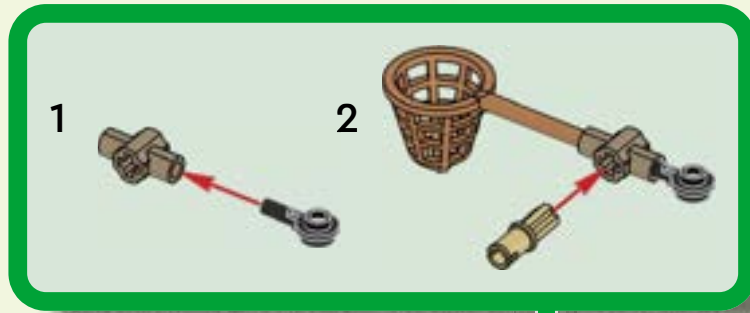

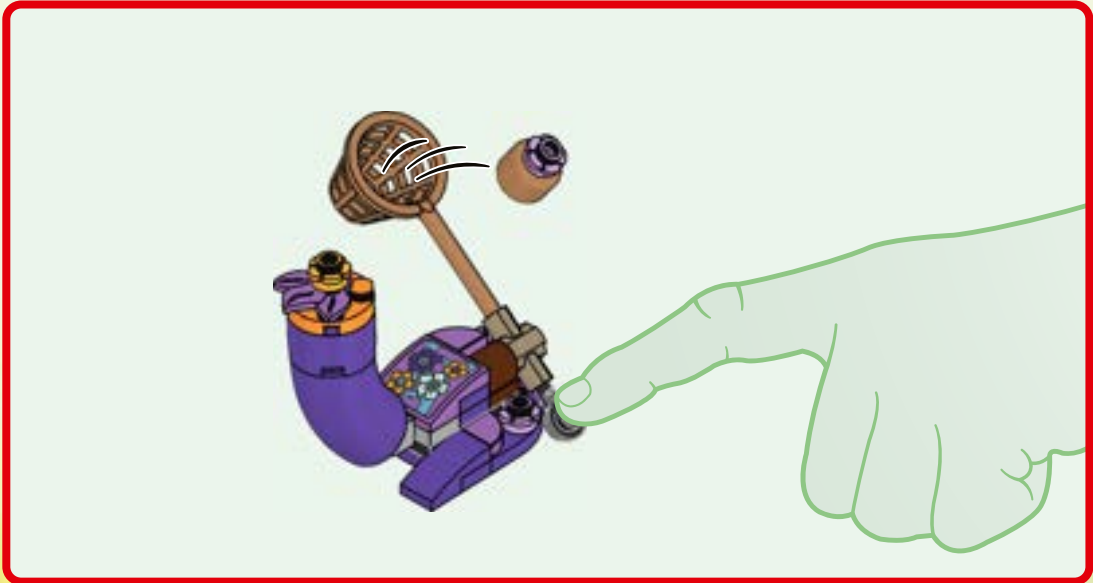
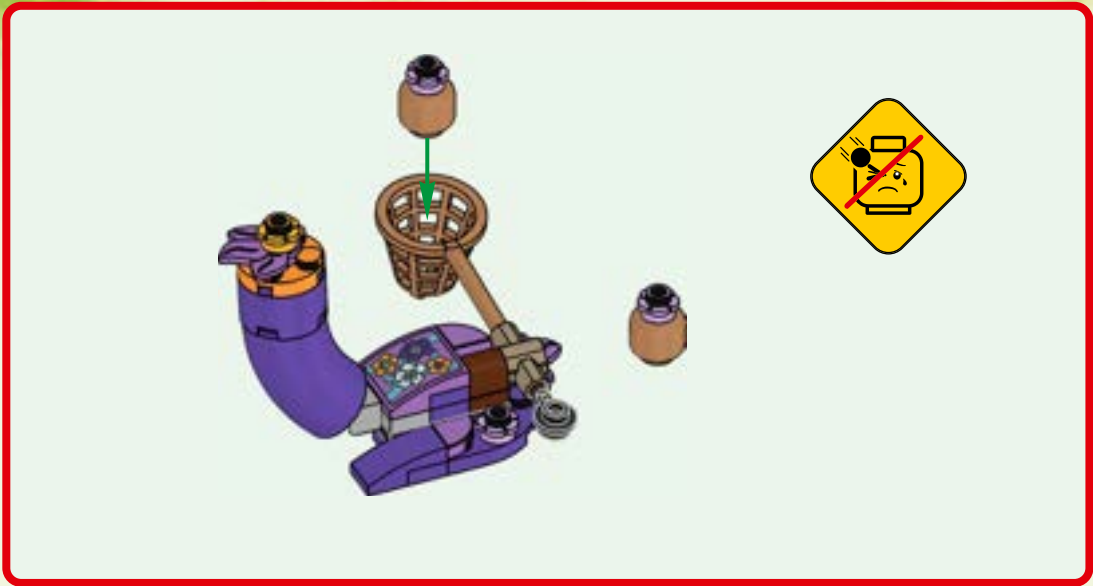





+



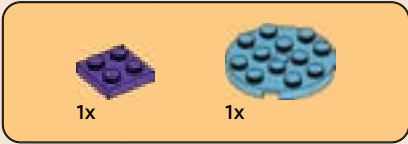

30

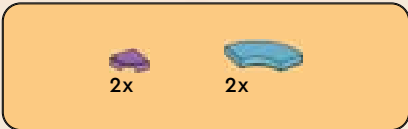

31

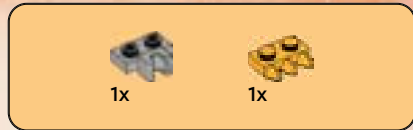

32

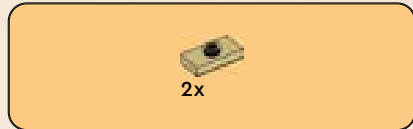

33





34



1x

35



1x



1x

36



37

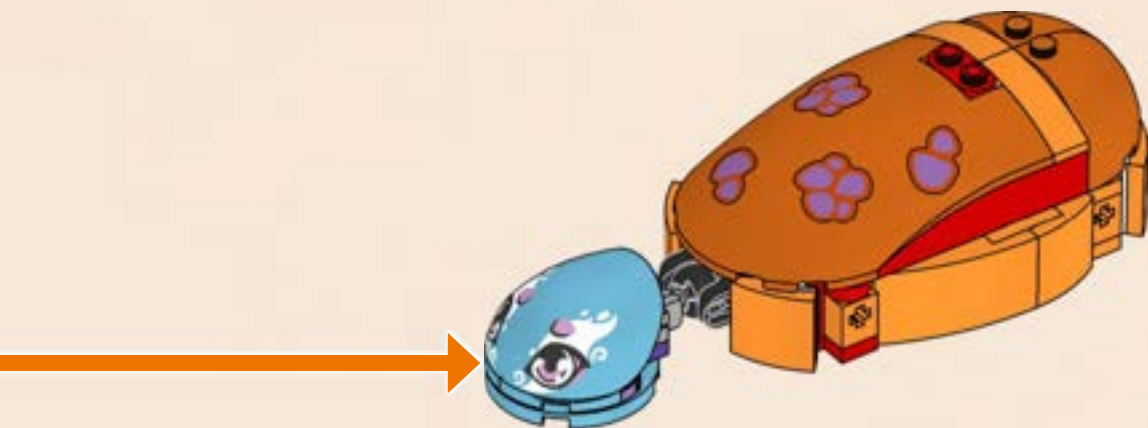

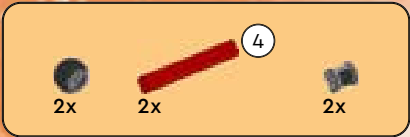

38

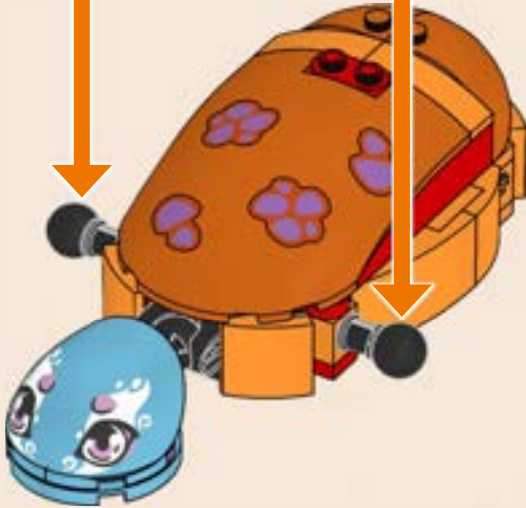
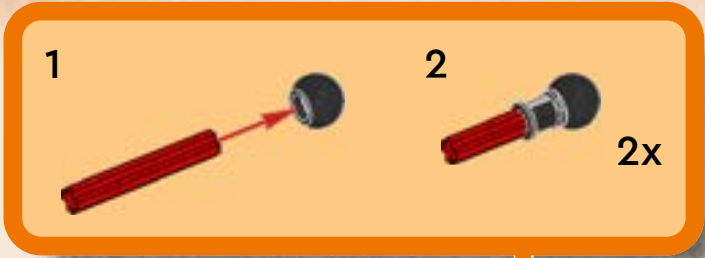





39



40

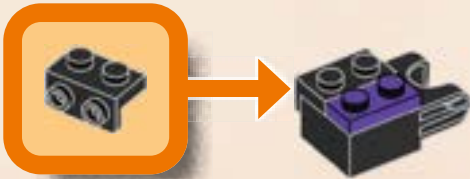

41

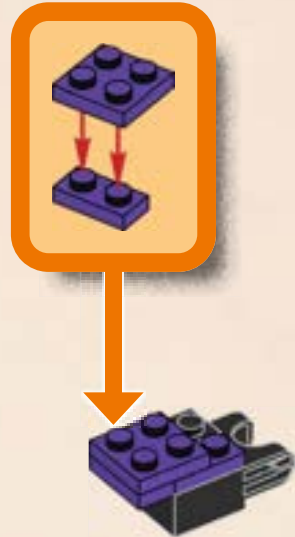



42

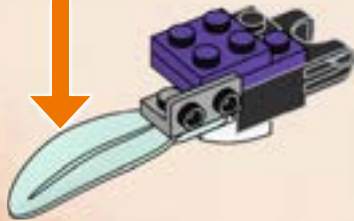
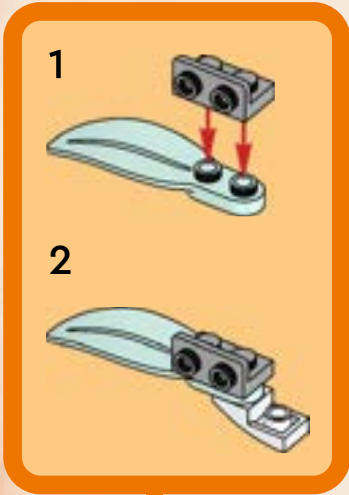

43

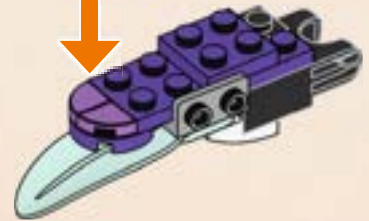
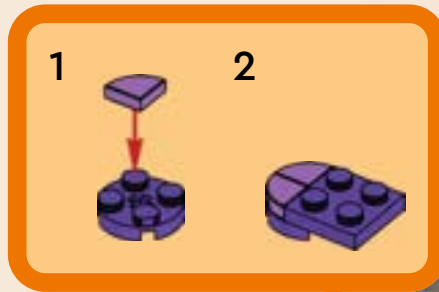



2x

44

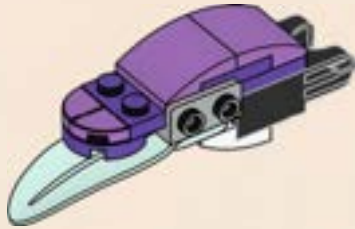

45

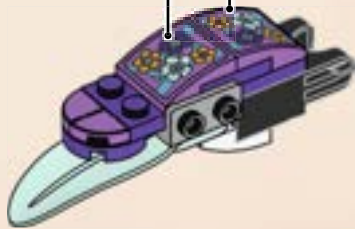

2x

46

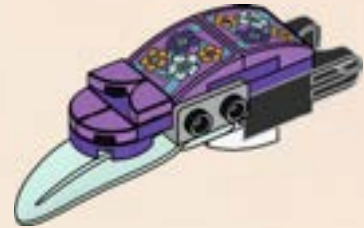

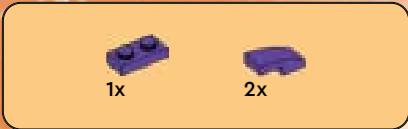

47

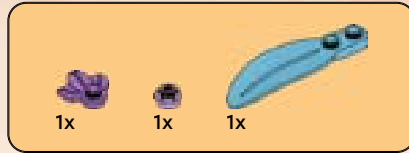
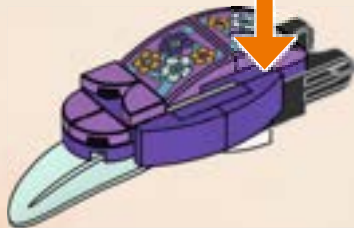
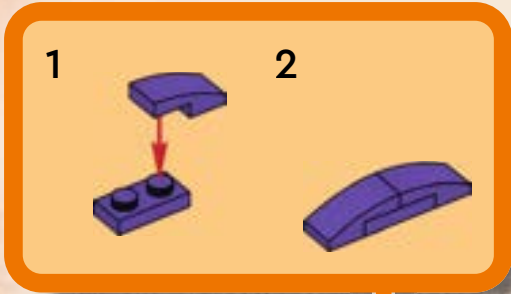

48

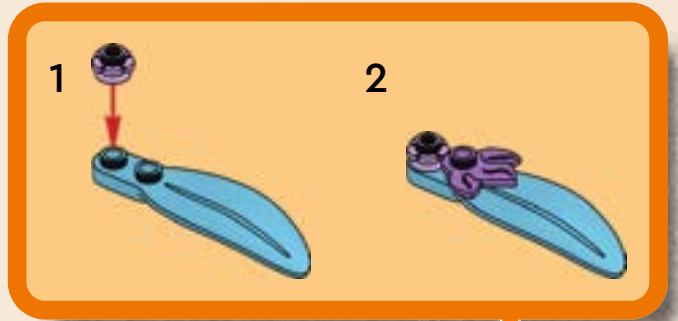

49

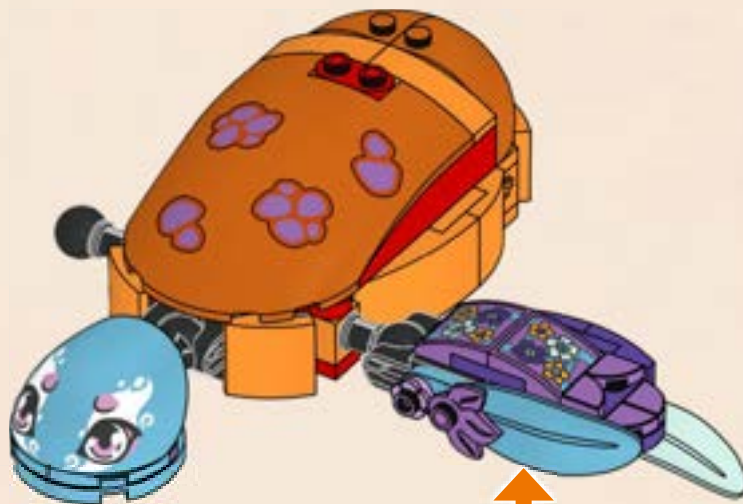



1x

50



1x



1x

51



1x



1x

52

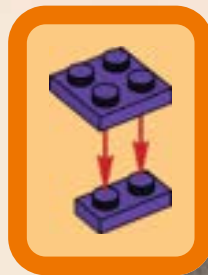



53

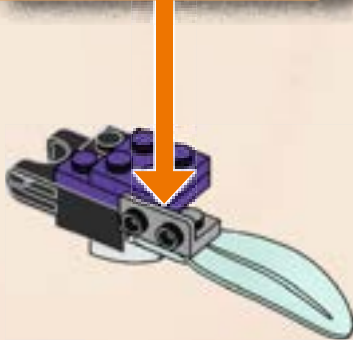
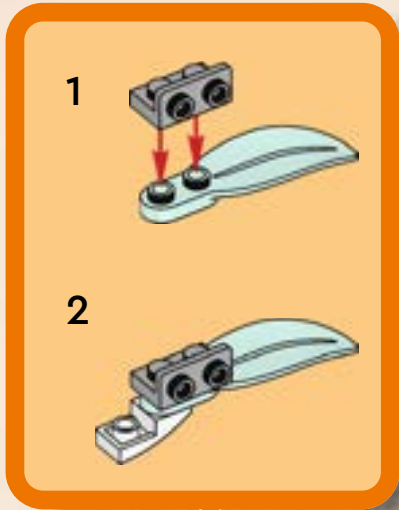

54

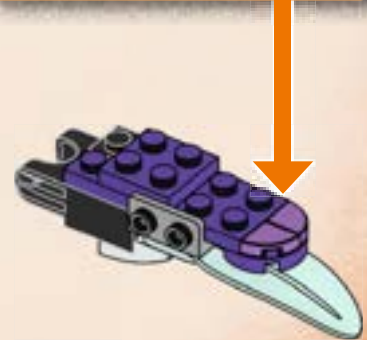
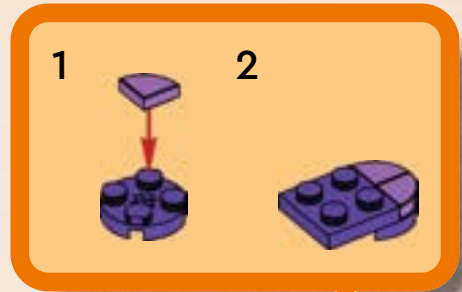



2x

55

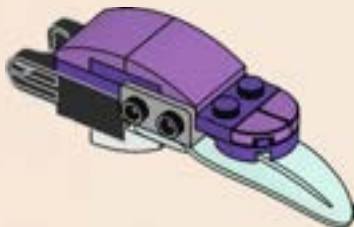

56

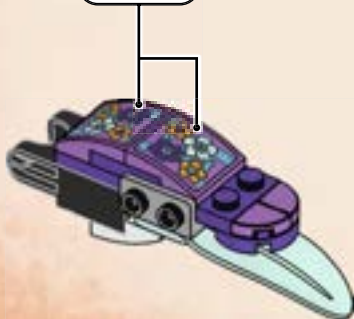

2x

57

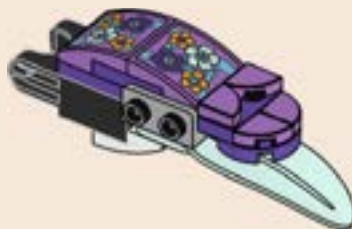



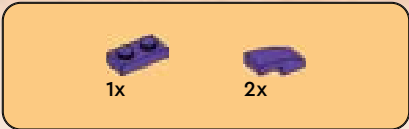

58

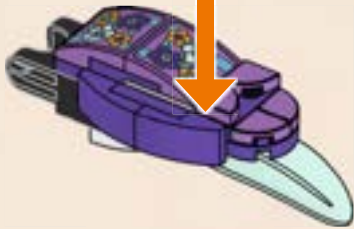
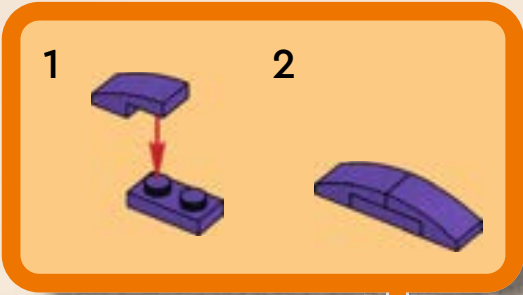

59

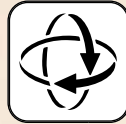
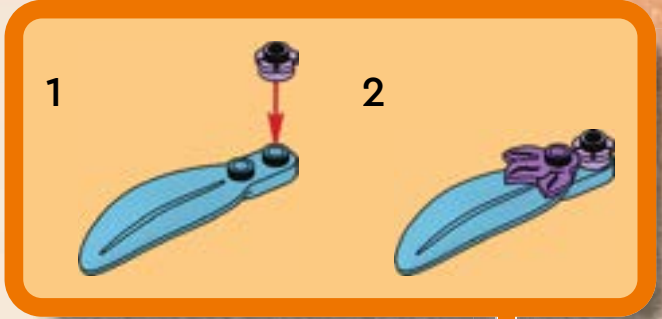

60

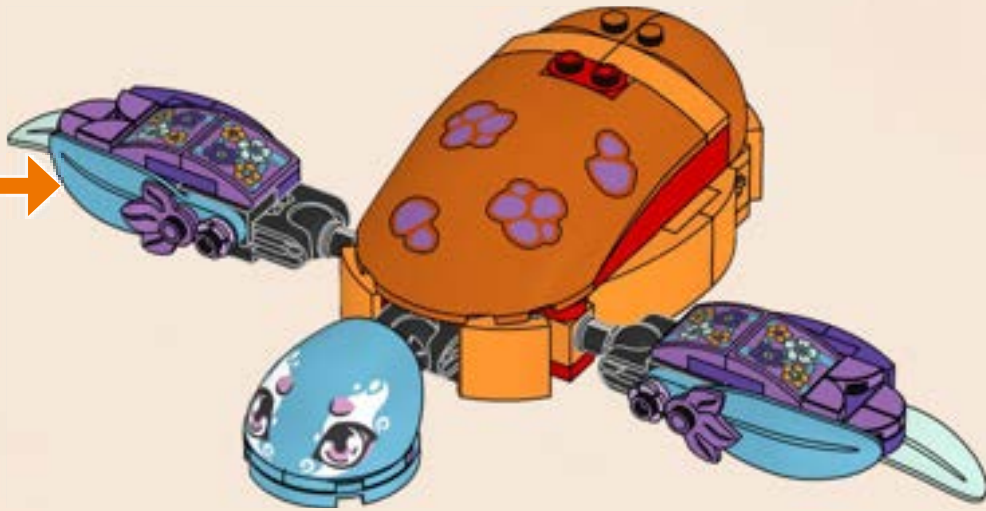



3x

61

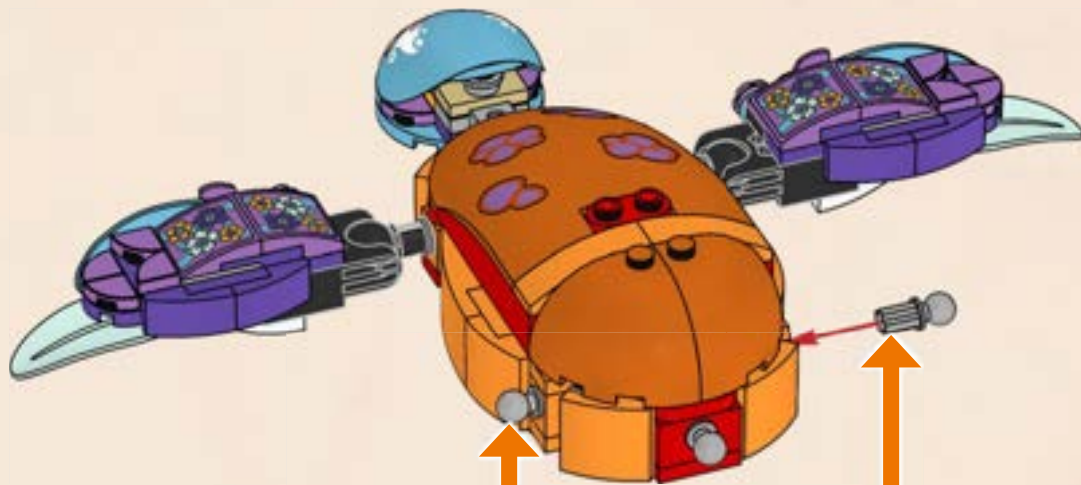

3x

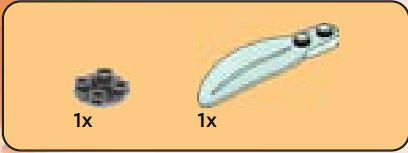

62

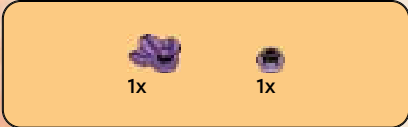
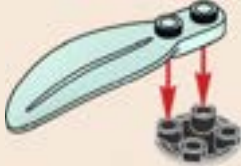

63

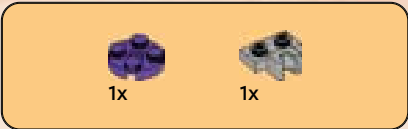

64

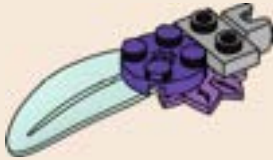



1x



2x

65



1x

67



2x

66



68



69

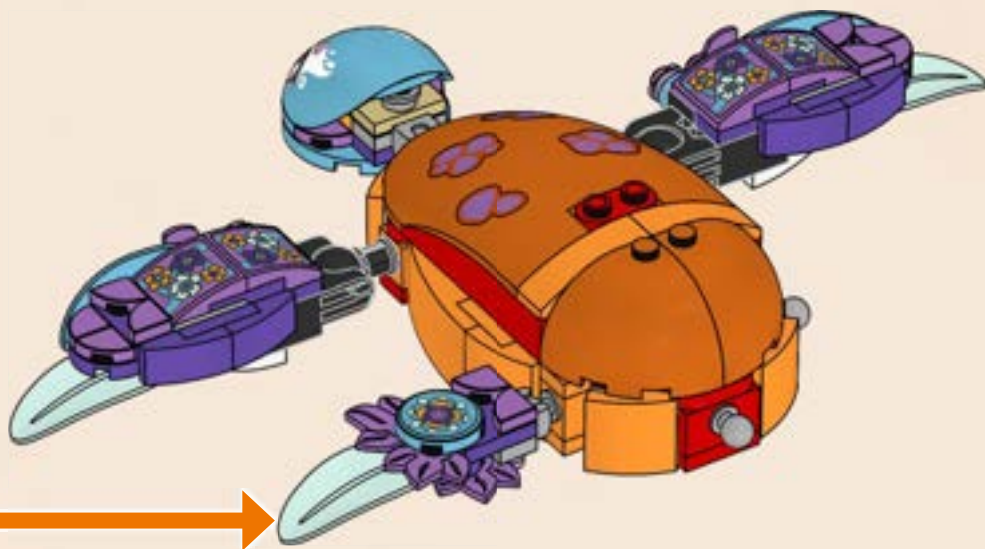

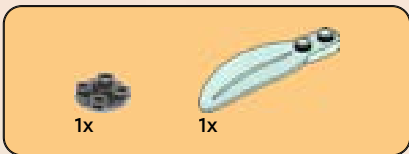

70

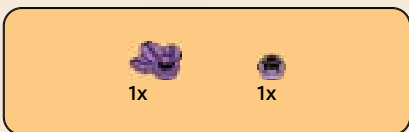
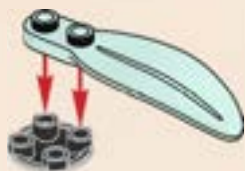

71

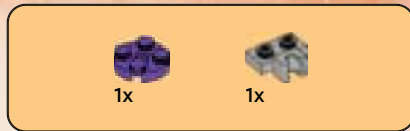

72





73

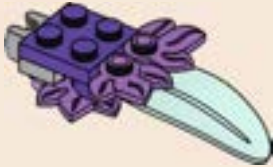

74

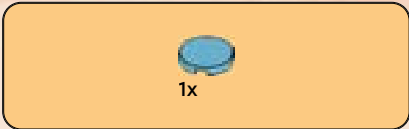

75



76





77

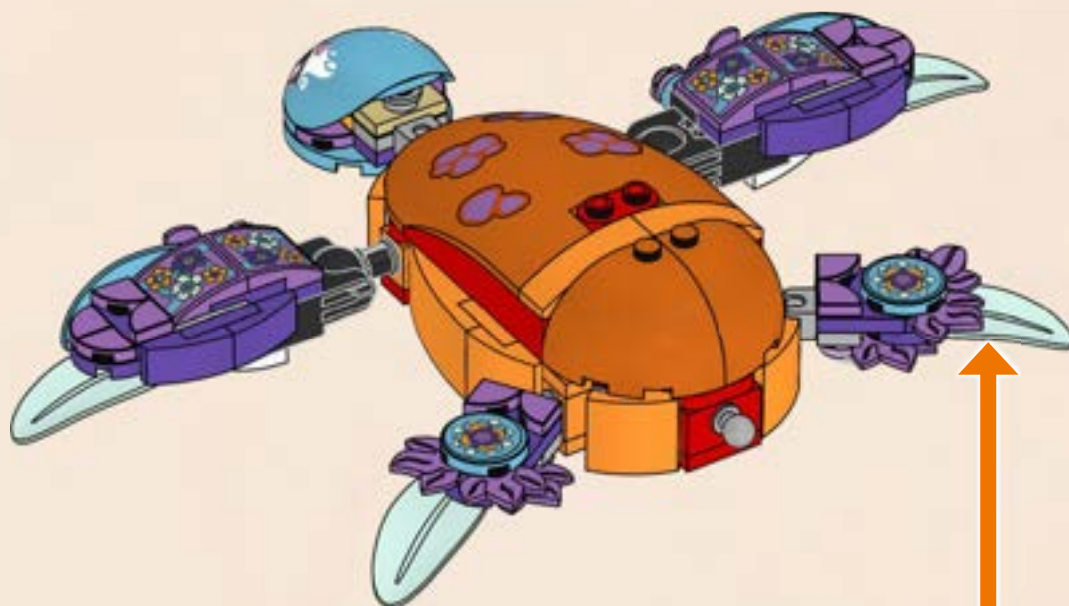



78

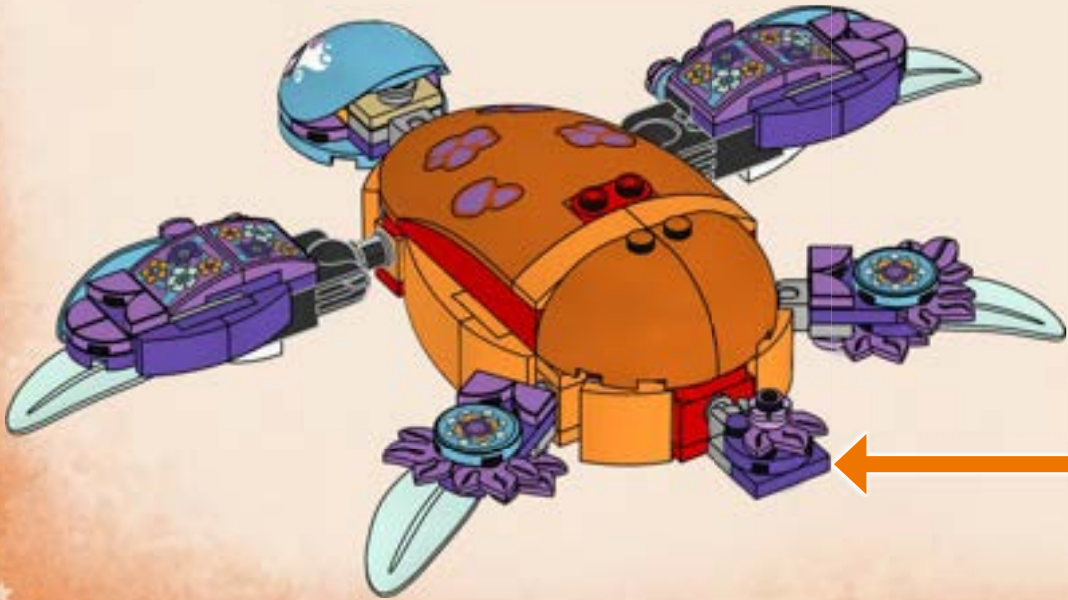



79

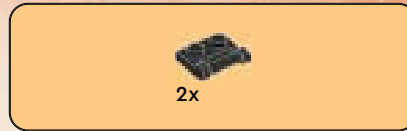
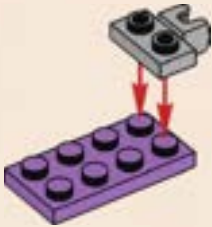

80



81





# 82

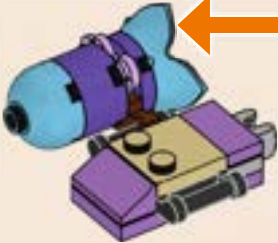



83

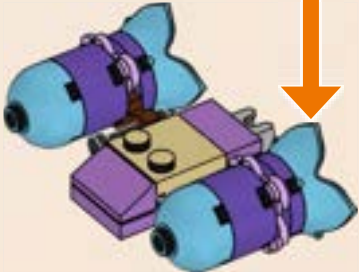

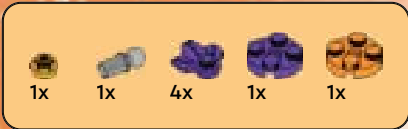

84

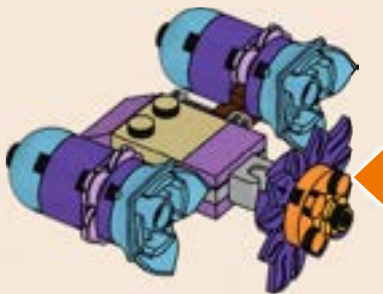

85

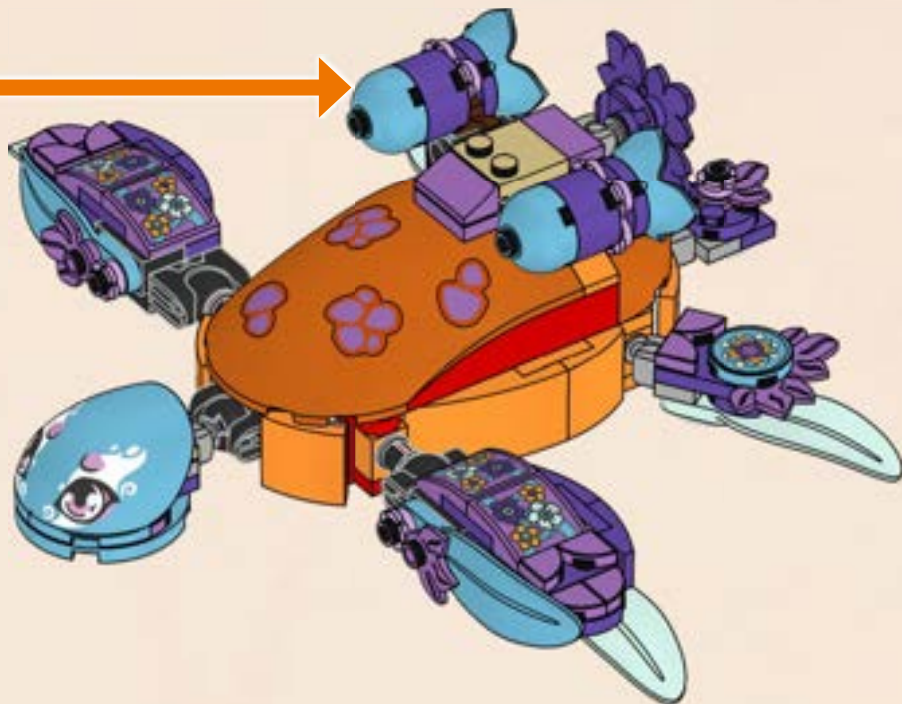



1

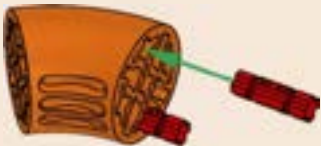

2

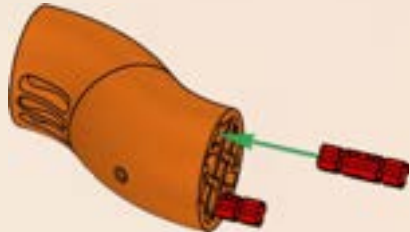

3

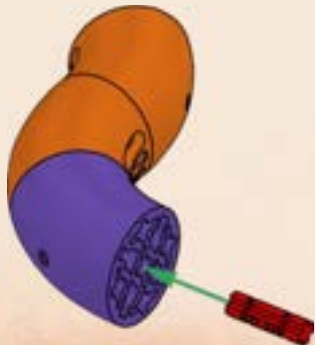





4

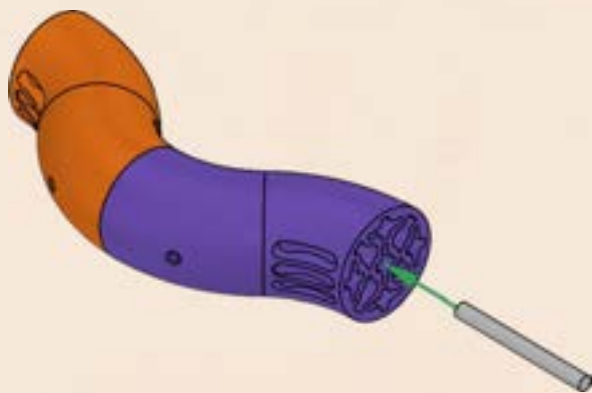

5

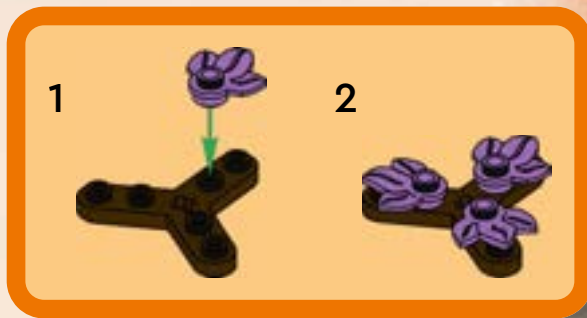

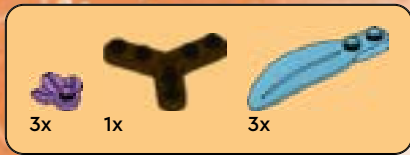

6

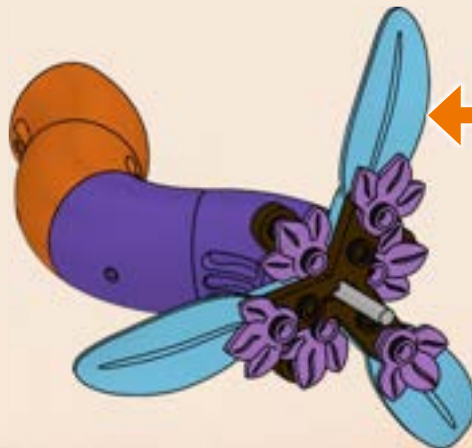
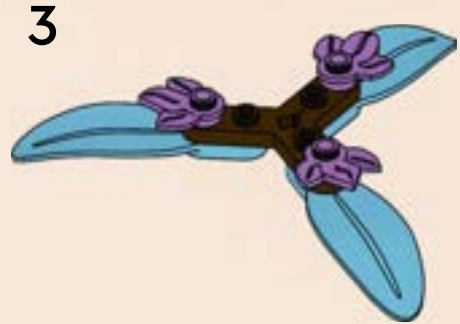
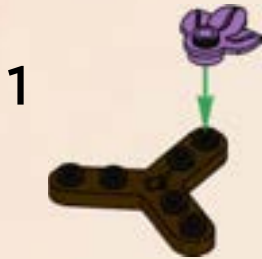

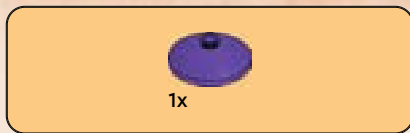

7

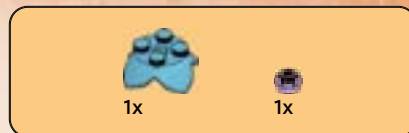

8

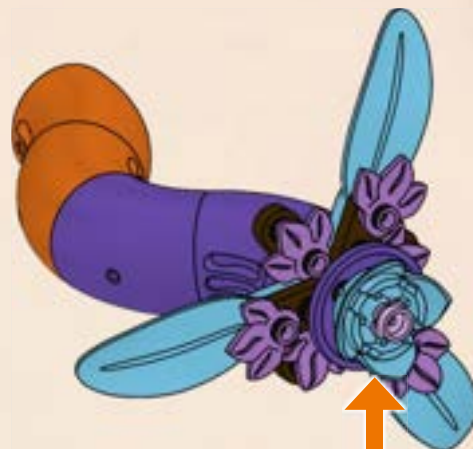



9

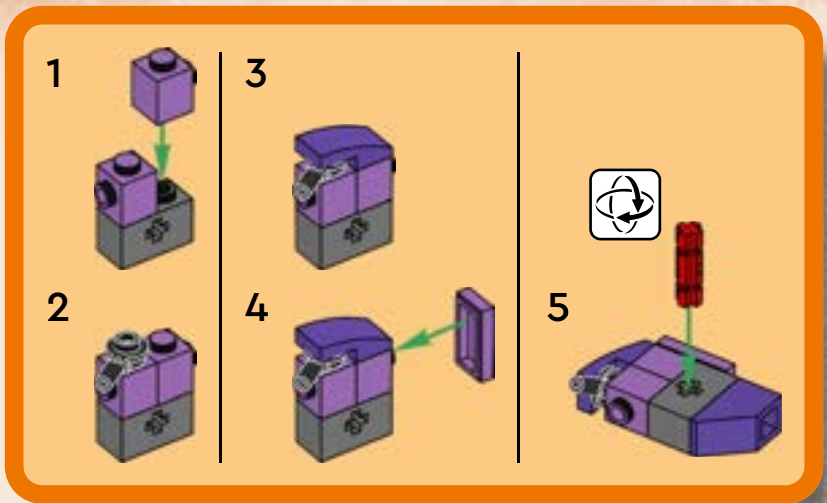



10





1



2



3



4





5

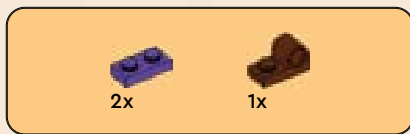

6

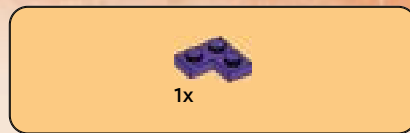

7

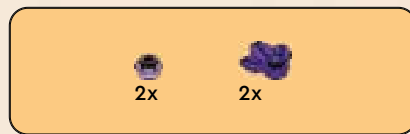

8





9

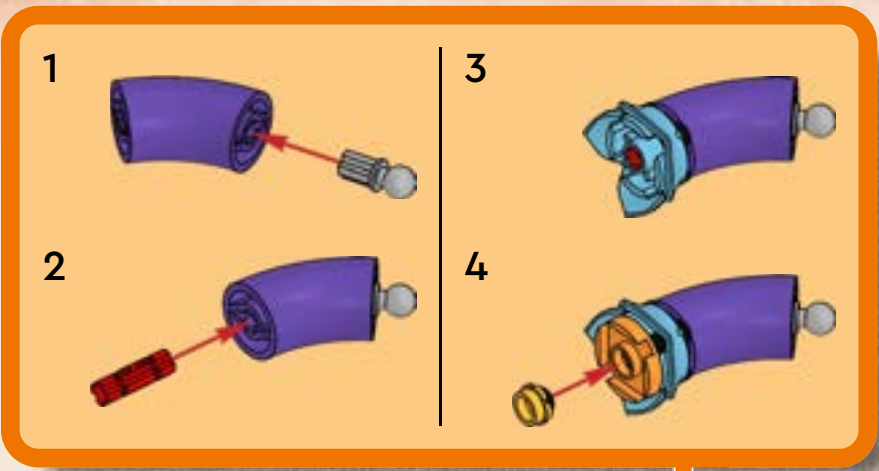



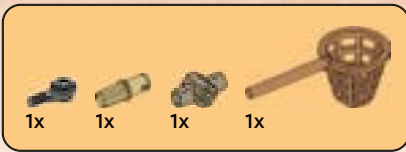

10



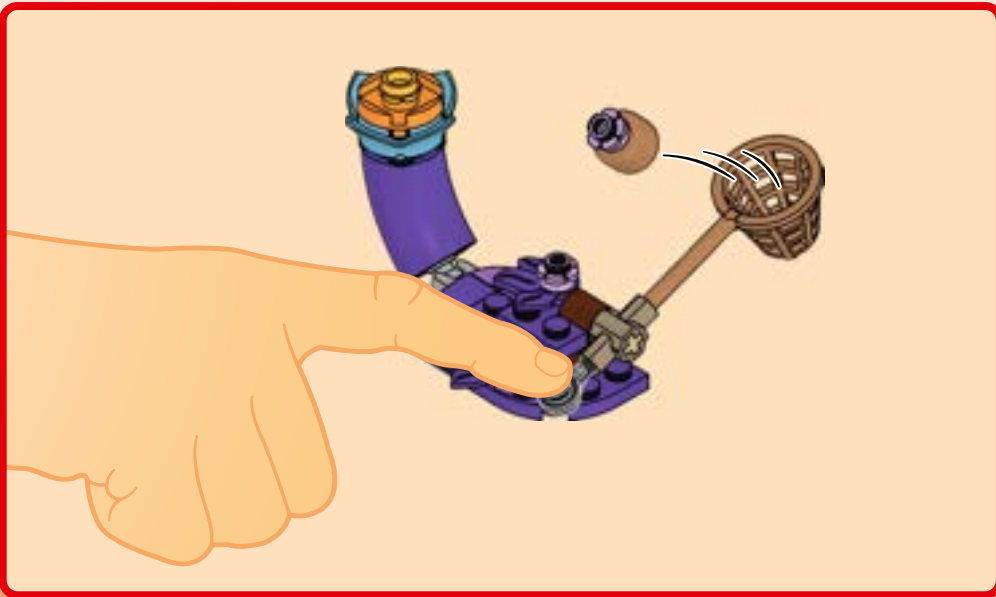





# DREAMZZZ



71481



71480



71483



71479



71484



71485



71478



# DREAMZZZ



**WATCH  
SERIES  
ONLINE** 

Watch series online  
Schau dir die Serie online an  
Regarde la série en ligne  
Guarda la serie online  
Mira la serie en Internet  
Assistir à série online  
在线观看  
Oglądaj serial w internecie

Sleduj seriál online  
Pozri si seriál online  
Nézd a sorozatot online  
Vizionează serialul online  
Гледайте сериала онлайн  
Skaties seriālu tiešsaistē  
Vaata sarja veebist  
Žiūrėk serialą internetu



 [LEGO.com/DREAMZZZ](https://LEGO.com/DREAMZZZ)

1x  
6487069

2x  
6172927

2x  
6166894

4x  
393801

2x  
6117940

1x  
6499166

2x  
371001

1x  
4666579

1x  
4218749

2x  
6092587

2x  
6214334

1x  
6221467

7x  
6210269

8x  
4142865

4x  
393721

1x  
6196217

2x  
242021

4x  
6129995

2x  
4160390

1x  
383221

1x  
6487066

5x  
6130007

1x  
4286267

2x  
4290713

2x  
6332148

2x  
6196548

4x  
4278359

1x  
6487071

4

3

2x  
6331716

1x  
6178922

2x  
6016172

4x  
6310268

4x  
4225201

1x  
4531412

1x  
302126

1x  
371026

3x  
6360825

1x  
6105963

1x  
4129572

1x  
6466880

1x  
6247792

4x  
6339309

3x  
6030521

4x  
4159007

6x  
6067913

2x  
4251969

1x  
6501161

2x  
6054529

1x  
4121741

1x  
6247796

1x  
6508633

1x  
6503633

1x  
6466858

2x  
4537936

1x  
6143445

1x  
6487068

1x  
6501089

1x  
6523618

1x  
6311435

3x  
6209681

1x  
6382584

4x  
6138731

2x  
6337003

1x  
6138664

1x  
6428805

2x  
6271165

2x  
6168647

6x  
6362975

6x  
6443149

6x  
6043656

2x  
6004990

1x  
6116608

4x  
4211385

4x  
4210639

2x  
6178919

1x  
6083620

1x  
4211006

6x  
6482646

8x  
6030534

2x  
4622176

10x  
4655695

1x  
6250643

6x  
6057390

4

8x  
6047422

1x  
6167461

1x  
6443492

1x  
6251900

4x  
6510160

2x  
6491527

1x  
6190252

1x  
6501459

2x  
6328094

2x  
6454735

1x  
6501165

1x  
6487079

1x  
6253187

1x  
6122727

2x  
6429058

2x  
6145255

5x  
6058746

2x  
6258069

3x  
4619513

1x  
6102828

1x  
6487080

5x  
6470919

4x  
6467799

16x  
6199893

2x  
6125776

15x  
6210460

1x  
6335182

2x  
6152645

4x  
6139090

1x  
4619516

16x  
6214235

1x  
6466042

1x  
6267417

1x  
6489687

1x  
6503197

2x  
6492177

2x  
6491526

1x  
6486043

1x  
6487037

1x  
6508817

 [LEGO.com/service](https://www.LEGO.com/service)



**YOU COULD WIN**

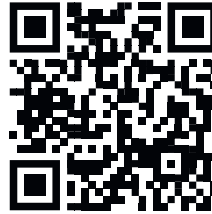

Scan this QR code or go to **LEGO.COM/PRODUCTFEEDBACK** and give us your short feedback about this LEGO® set for a chance to win a cool LEGO prize.

Terms and Conditions apply\*

**EN: YOU COULD WIN.** Terms and Conditions apply\* **DE: Du könntest GEWINNEN.** Es gelten die Teilnahmebedingungen\* **FR: Tu pourrais GAGNER.** Des conditions s'appliquent\* **IT: Potresti VINCERE tu.** Termini e condizioni sono applicabili\* **ES: Puedes GANAR.** Aplican términos y condiciones\* **PT: Poderá GANHAR.** Aplicam-se termos e condições\* **ZH: 轻松获奖. 条款和条件适用\*** **PL: Szansa na WYGRANĄ.** Obowiązują warunki korzystania\* **CS: Máte šanci VYHRÁT.** Platí všeobecné smluvní podmínky\* **SK: Máte šancu VYHRAŤ.** Platia všeobecné zmluvné podmienky\* **HU: TE IS NYERHETSZ.** Felhasználási feltételek érvényesek\* **RO: Ai putea CÂȘTIGA.** Se aplică termeni și condiții\* **BG: Можете да СПЕЧЕЛИТЕ.** Има определени правила и условия\* **LV: Tu vari LAIMĒT.** Ir spēkā noteikumi un nosacījumi.\* **ET: Sul on võimalus VÕITA.** Kehtivad tingimused\* **LT: Jūs galite LAIMĖTI.** Taikomos sąlygos\*

\*[LEGO.com/productfeedback-terms](https://www.lego.com/productfeedback-terms)