



# CITY

60423







LEGO® Builder



[LEGO.com/sustainable-packaging](https://LEGO.com/sustainable-packaging)



 **FR**  
**DONNEZ**  
OU  
**RECYCLEZ**

 OU  OU 

ASSOCIATION    MAGASIN    DÉCHÈTERIE

Adresses sur [quefairedemesdechets.fr](https://quefairedemesdechets.fr)



Q LEGO® Builder

# BUILDER



Apple and the Apple logo are trademarks of Apple Inc., registered in the U.S. and other countries and regions. App Store is a service mark of Apple Inc. Google Play and the Google Play logo are trademarks of Google LLC. Tencent and the Tencent logo are trademarks of Tencent Inc.

Q [LEGO.com/devicecheck](https://lego.com/devicecheck)

**EN** Ask parents' permission before going online | **DE** Eltern um Erlaubnis bitten, bevor du online gehst | **FR** Demande l'autorisation d'un parent avant d'aller en ligne | **IT** Chiedi il permesso ai tuoi genitori prima di andare online | **ES** Pídeles permiso a tus papás antes de conectarte a Internet | **PT** Pede autorização aos pais antes de acederes online | **ZH** 上网前应先征得父母的同意 | **PL** Poproś rodziców o zgodę, zanim wejdziesz do Internetu | **CS** Než půjdeš na internet, požádej rodiče o svolení | **SK** Skôr než pôjdeš na internet, vypýtaj si povolenie od rodičov | **HU** Kérj szülői engedélyt, mielőtt online csatlakoznál! | **RO** Cere permisiunea părinților înainte de a te conecta online | **BG** Поискайте разрешение от родител, преди да влезете онлайн | **LV** Pirms došanās tiešsaistē palūdz atļauju vecākiem | **ET** Enne Interneti kasutamist küsi vanematelt luba | **LT** Prieš prisijungdami prie interneto, atsiklauskite tėvų

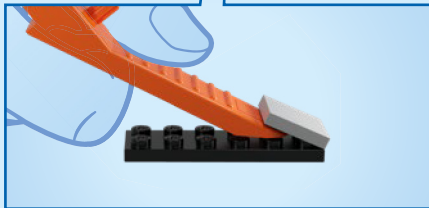
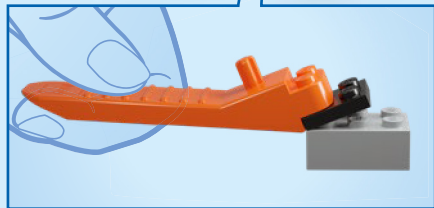
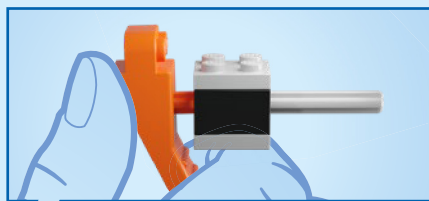
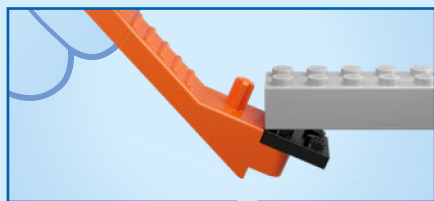

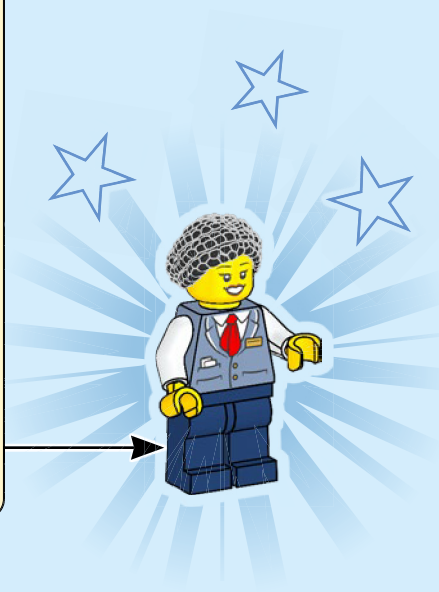
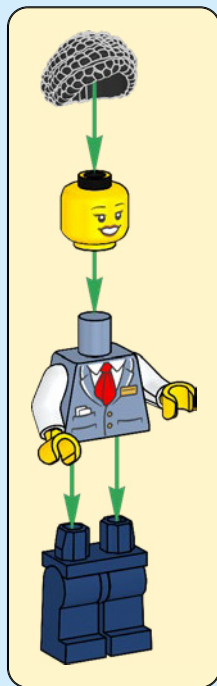

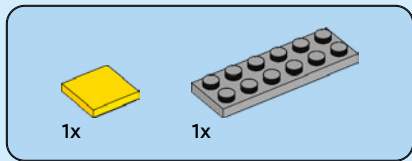

1

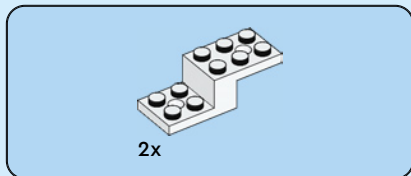
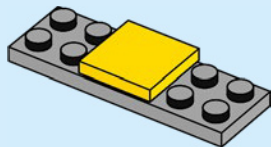

2

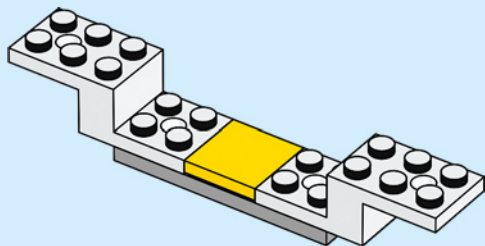

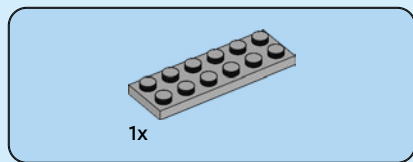

3

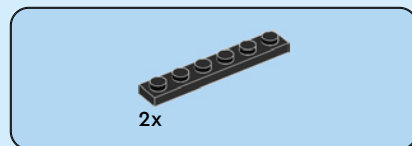
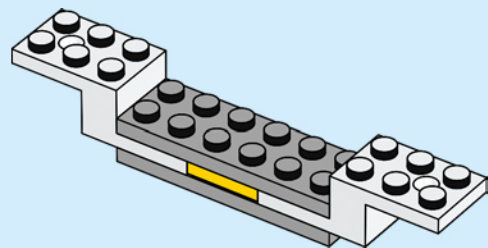

4

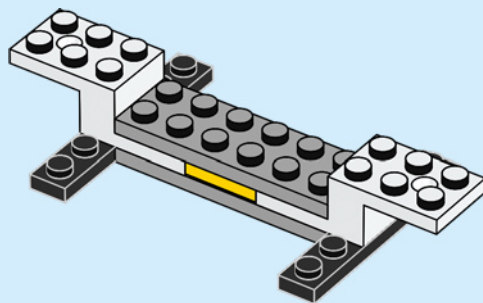



4x



4x

5

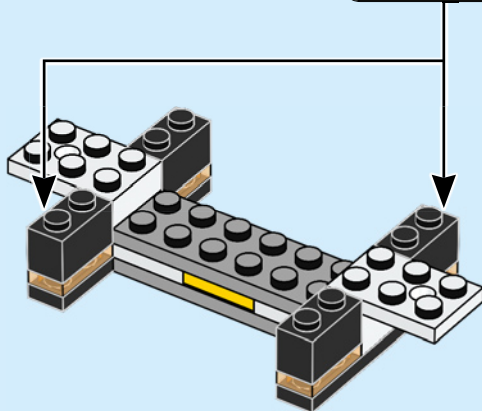
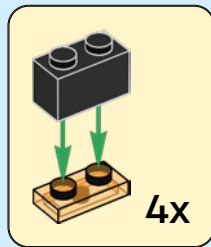



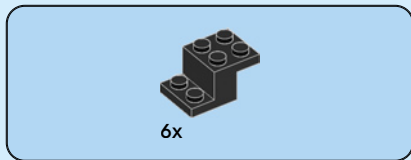

6

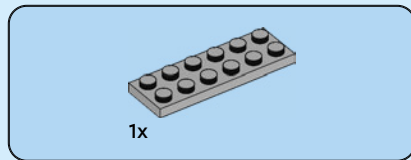
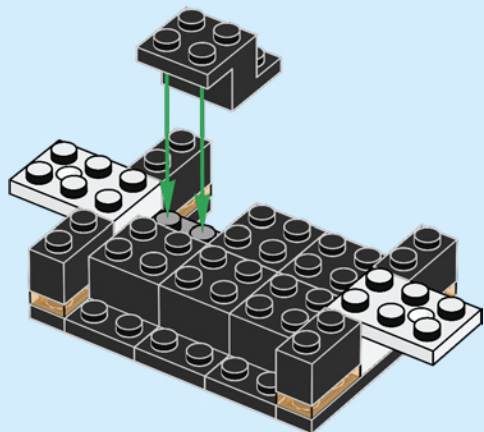

7

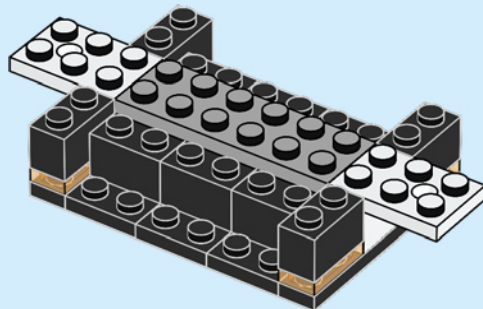

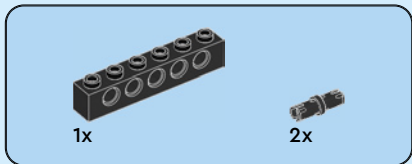
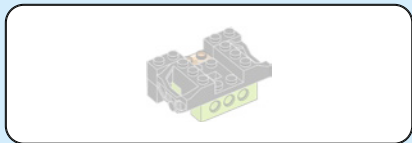

8

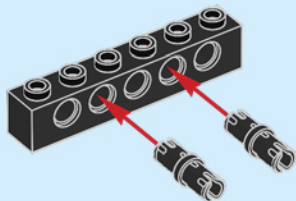

10

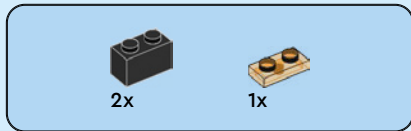

9

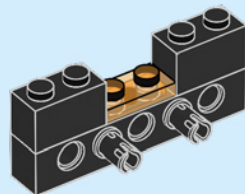

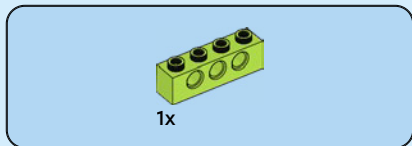

10

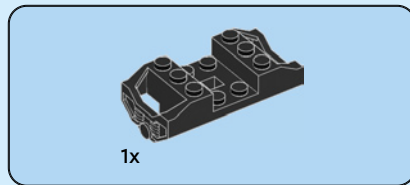
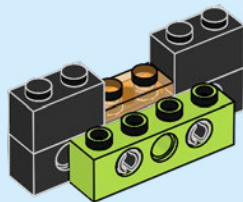

11

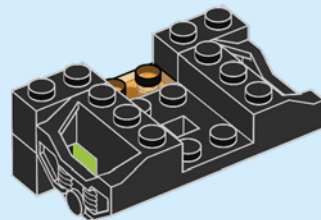

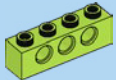

1x

12

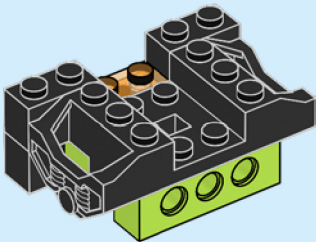

13

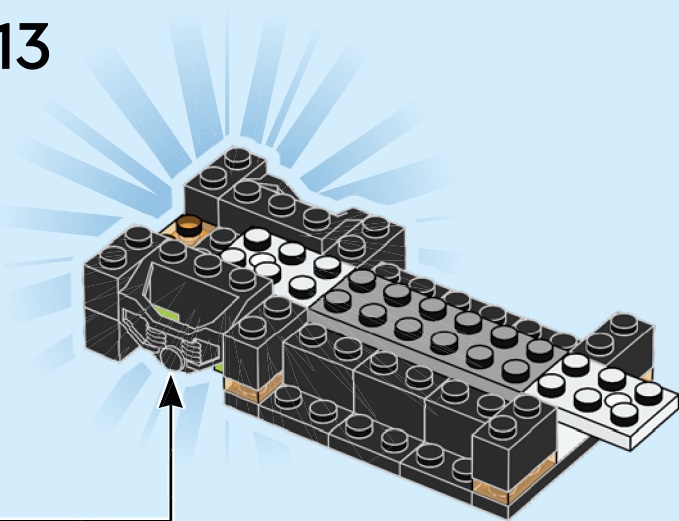



1x

14

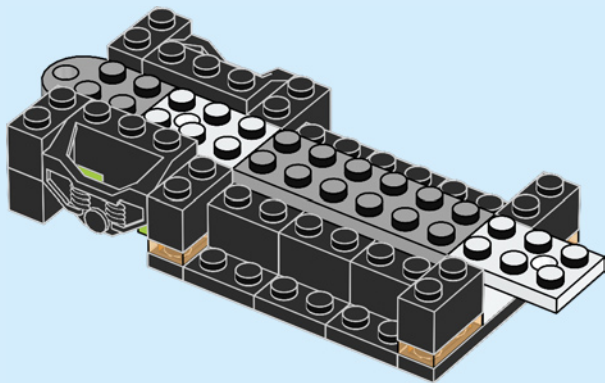

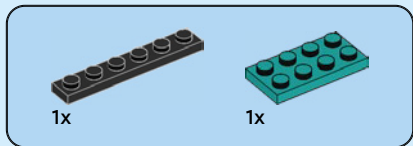

15

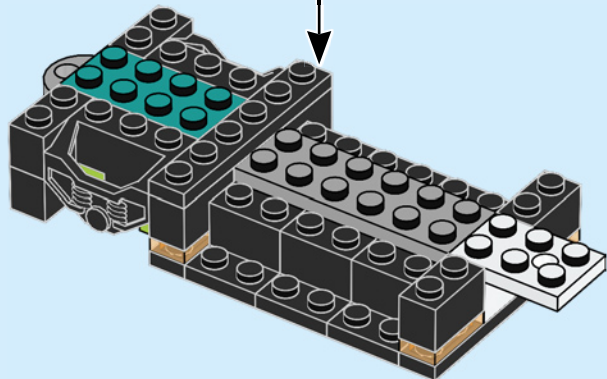
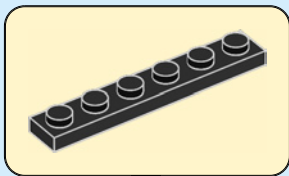

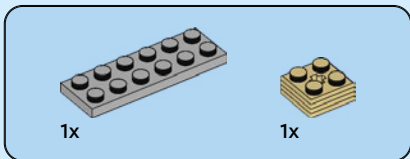
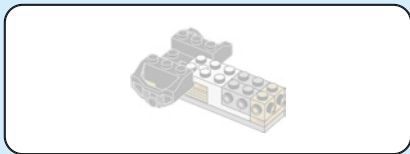

16

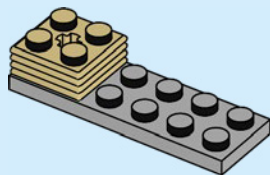

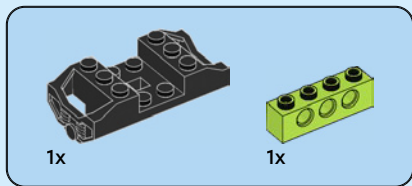

17

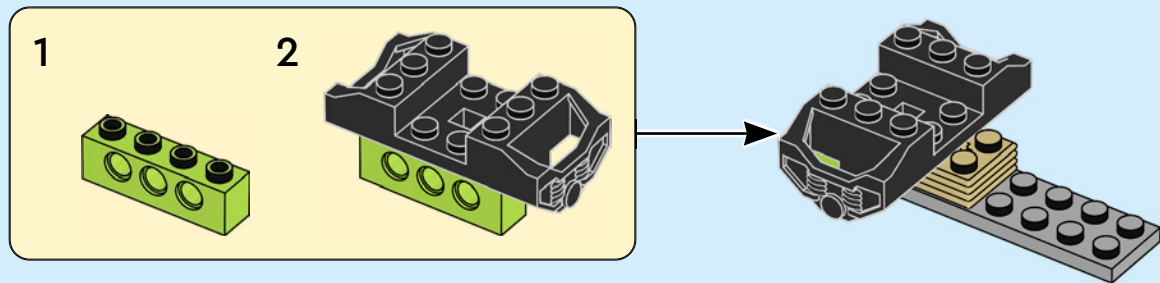





18

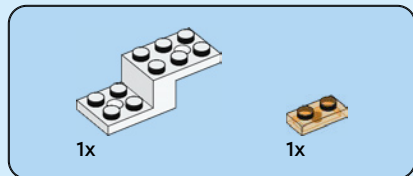
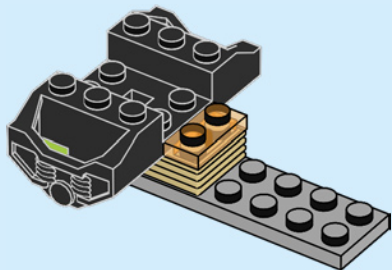

19

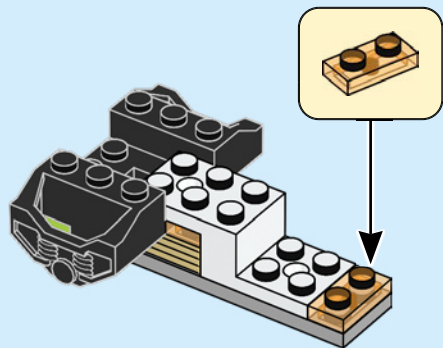



2x

20

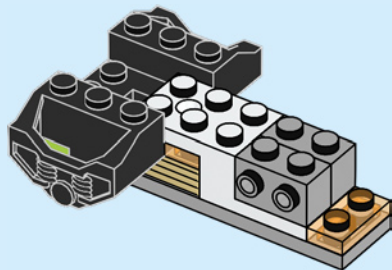

2x

21

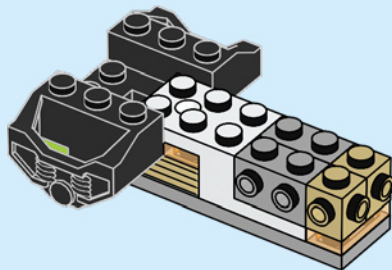

22

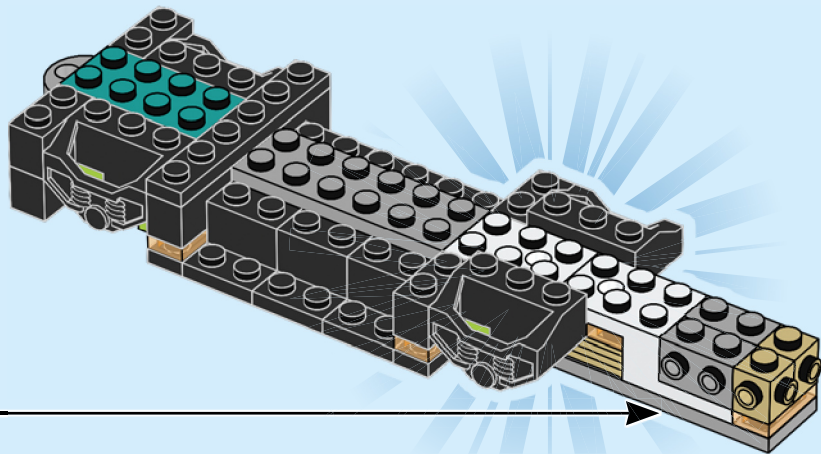

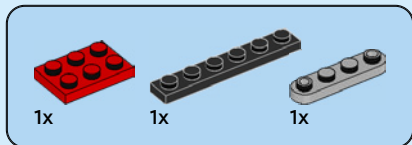

23

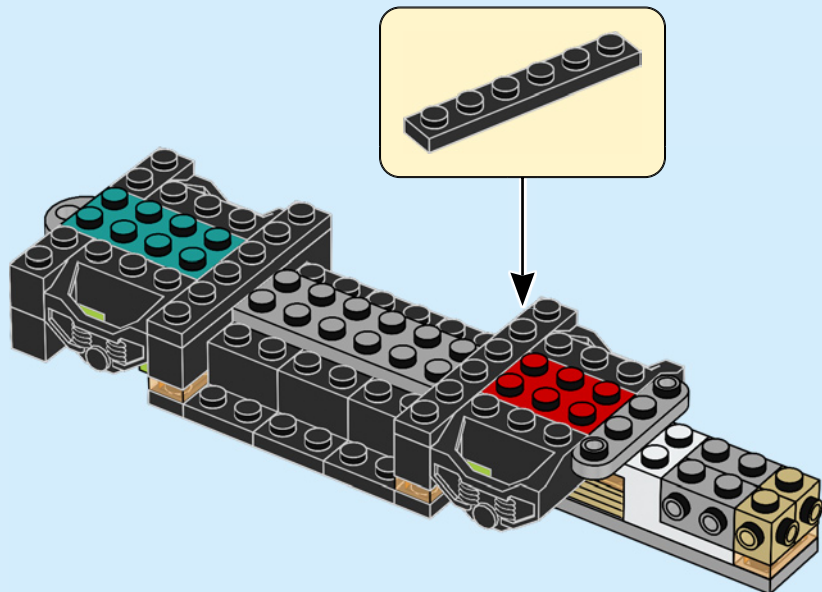



1x



1x

# 24

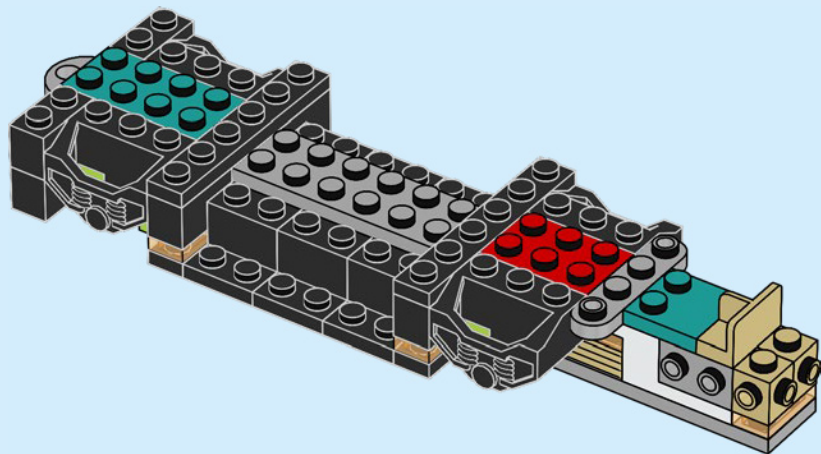



25

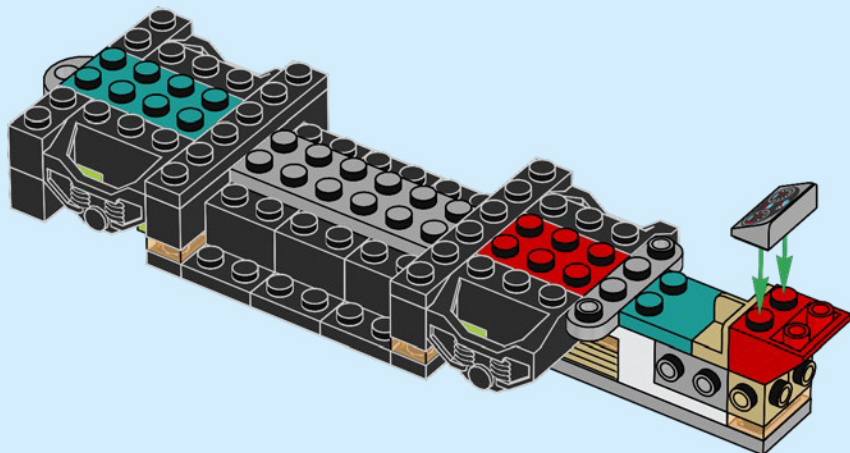



2x



1x

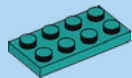

1x

26

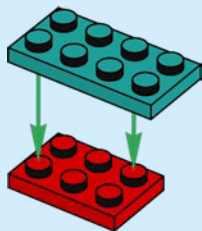

1x

27

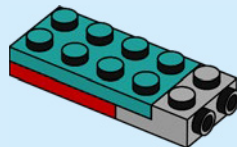



1x



1x

28

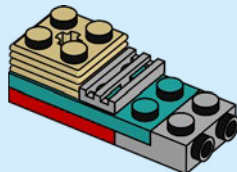

1x



1x

29

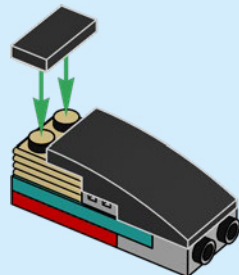

2x





30

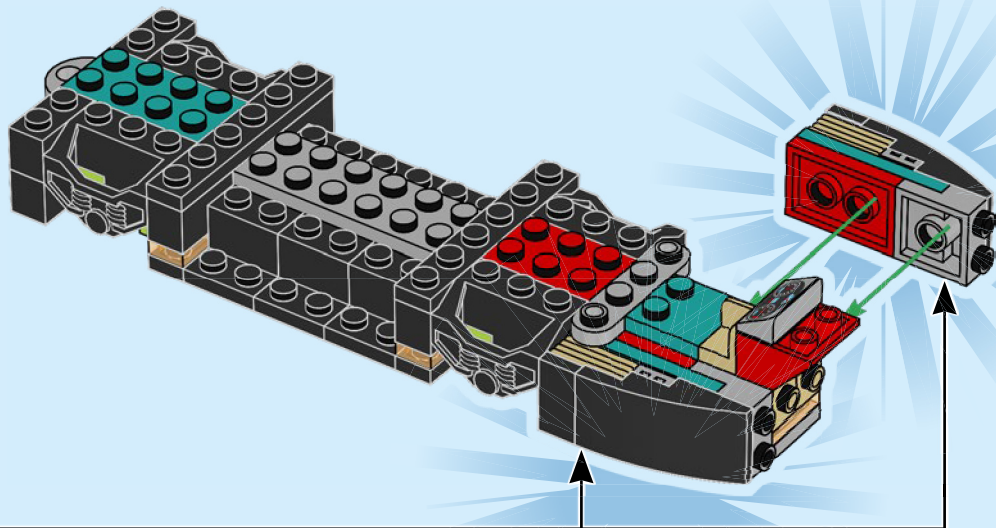



2x

31

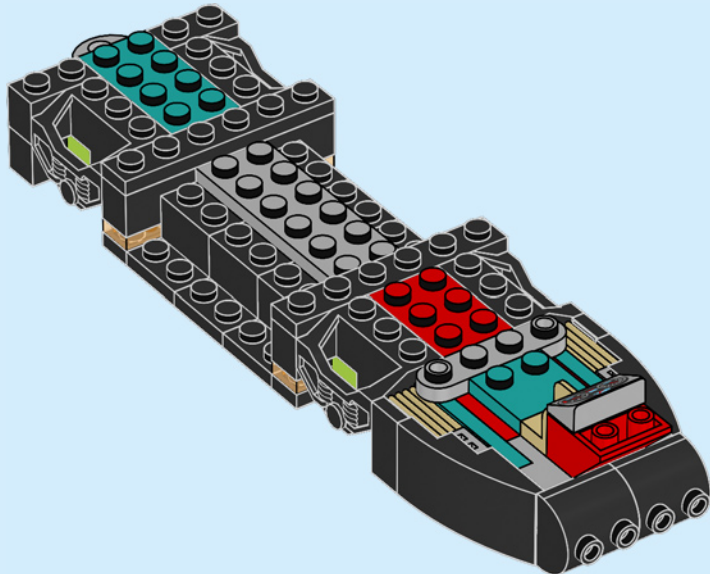



1x



2x

# 32

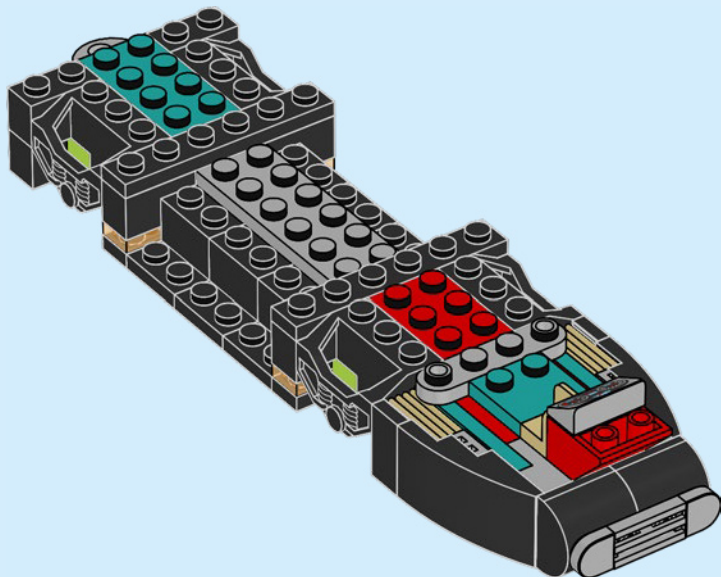

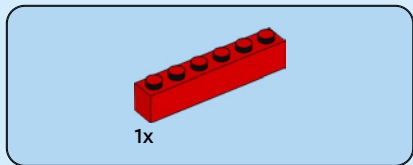

33

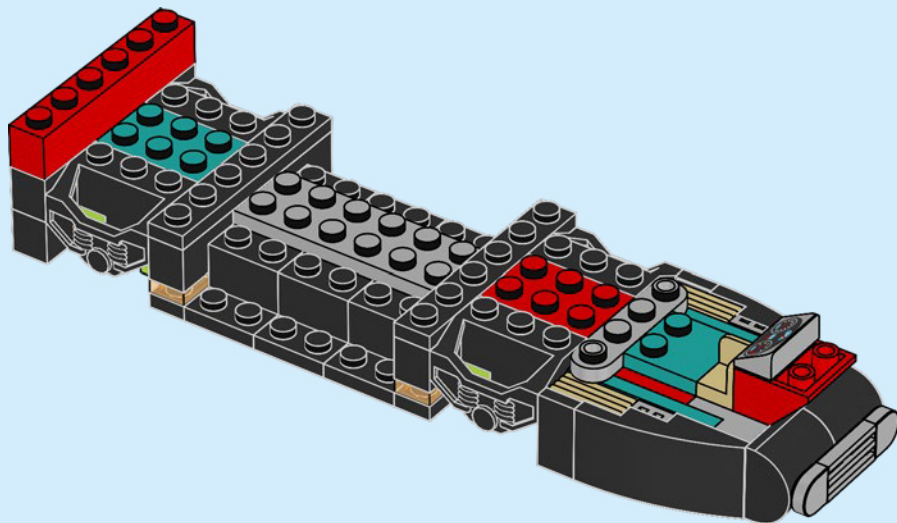

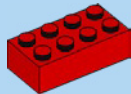

2x

# 34

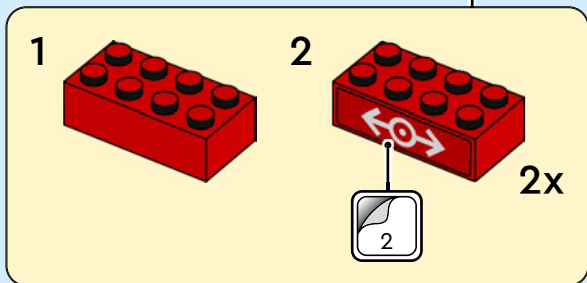
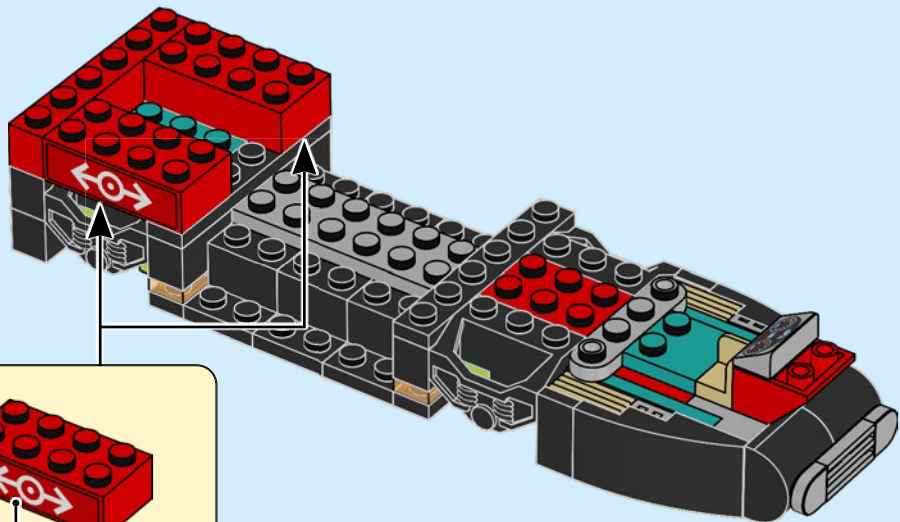



2x

# 35

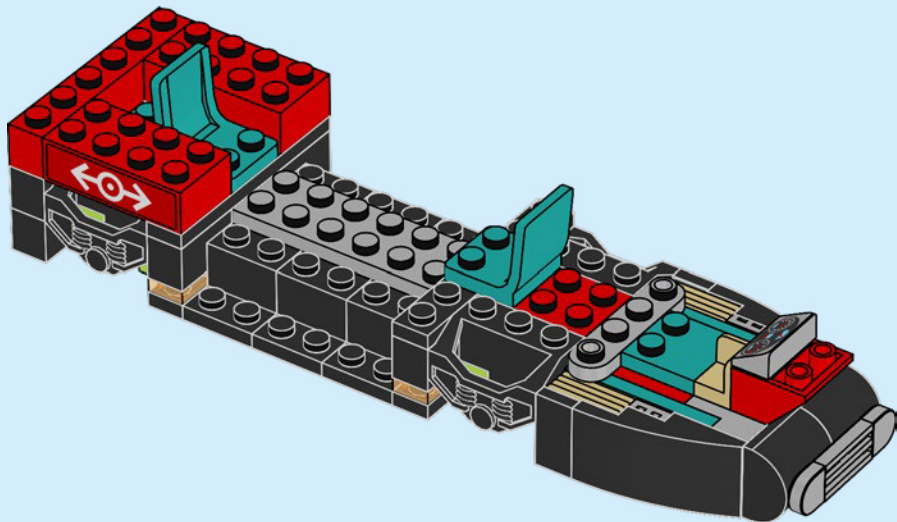

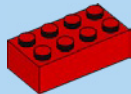

2x

36

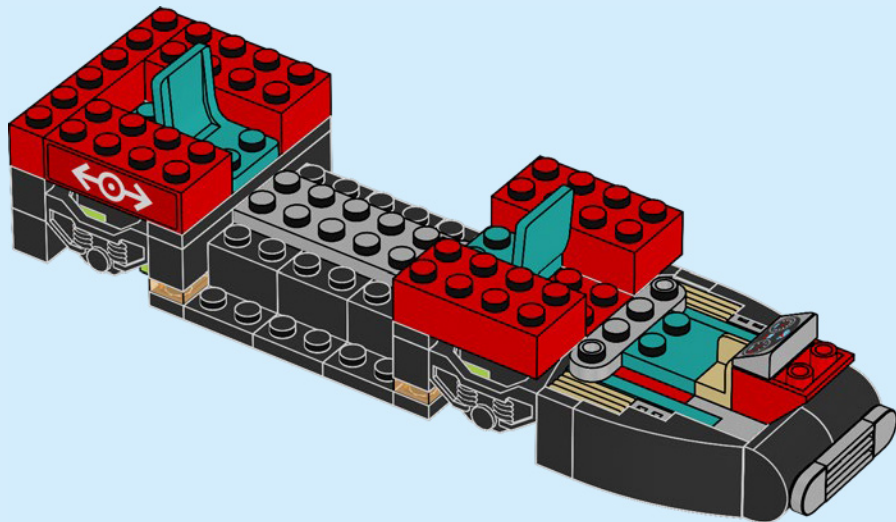







1x

37

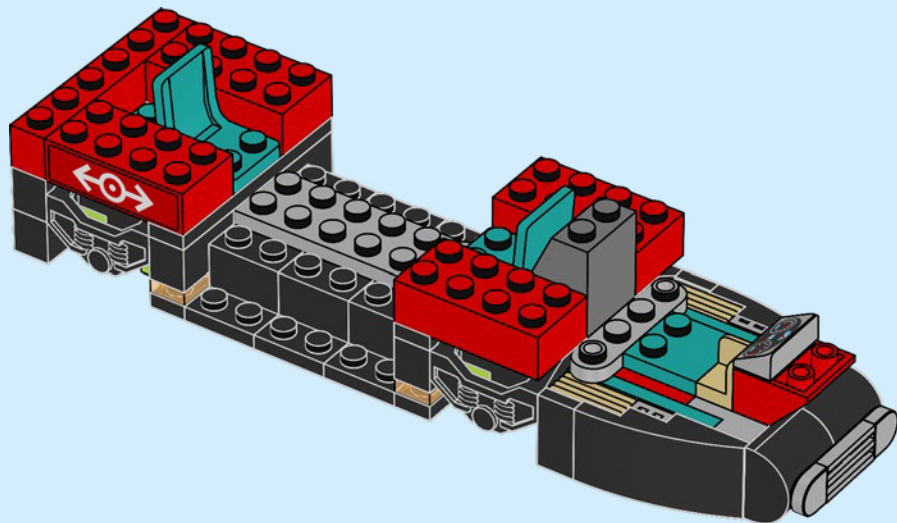



2x

38

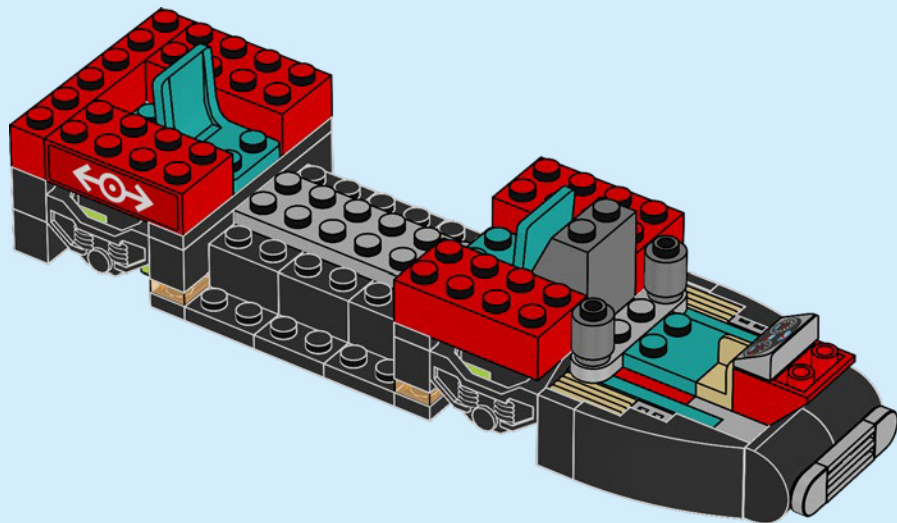



1x

39

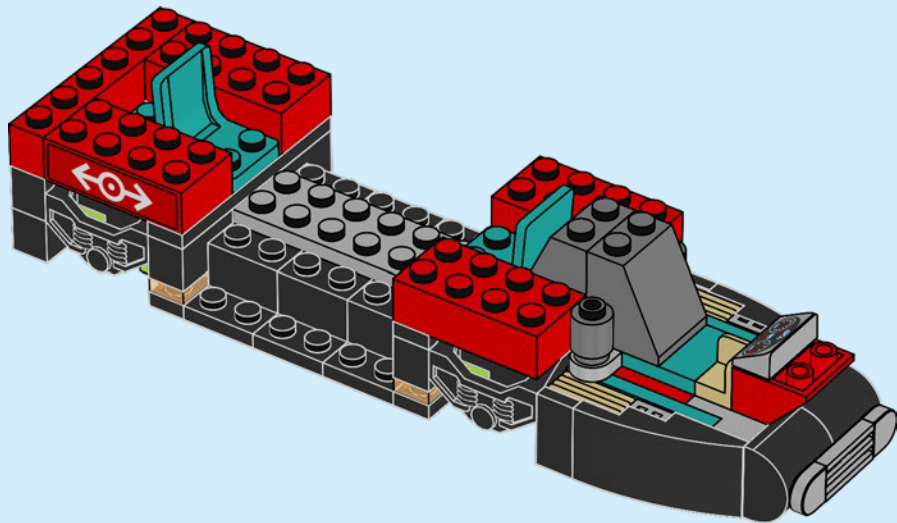



2x

40

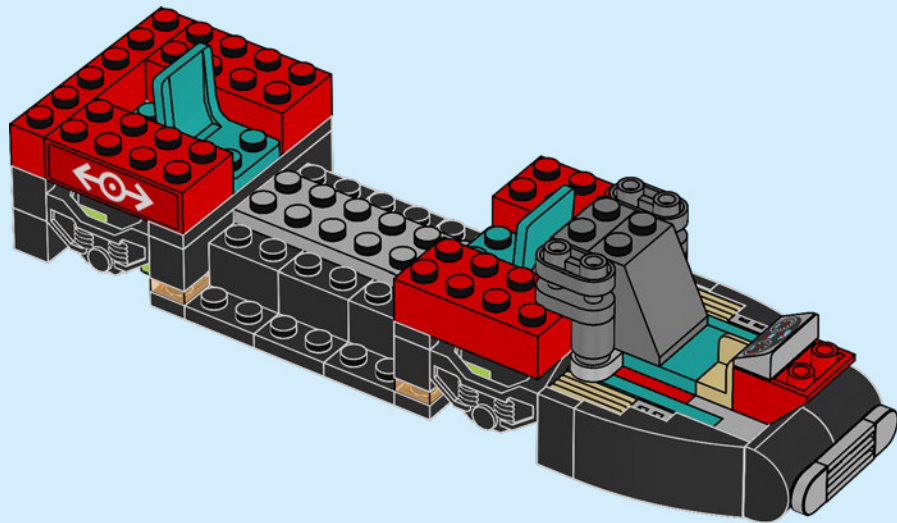



2x

41

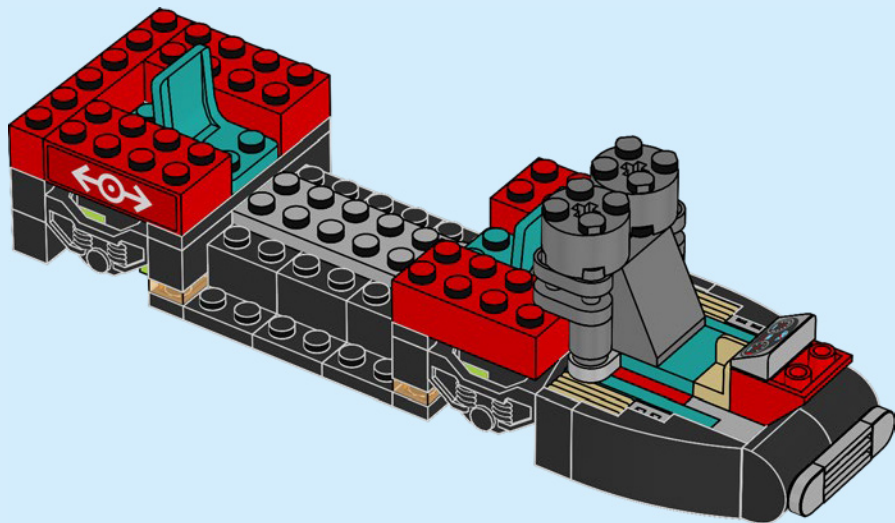



1x



2x

42

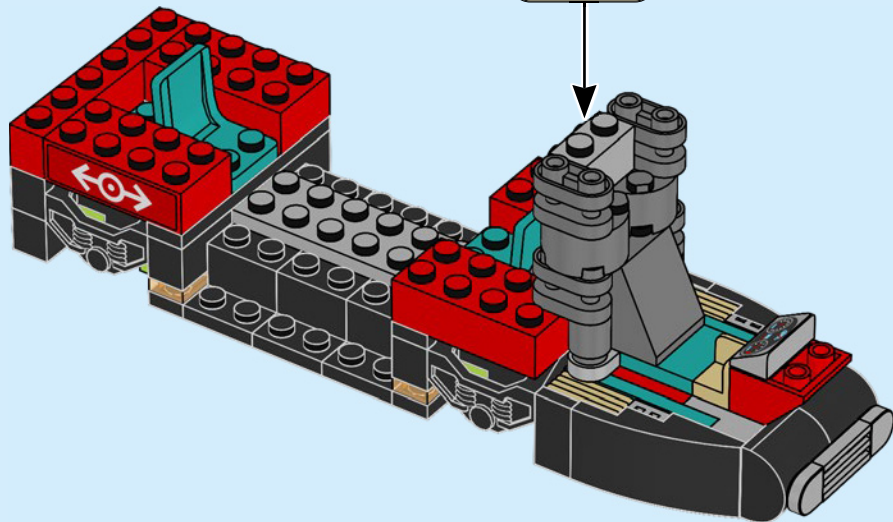
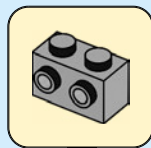



1x

# 43

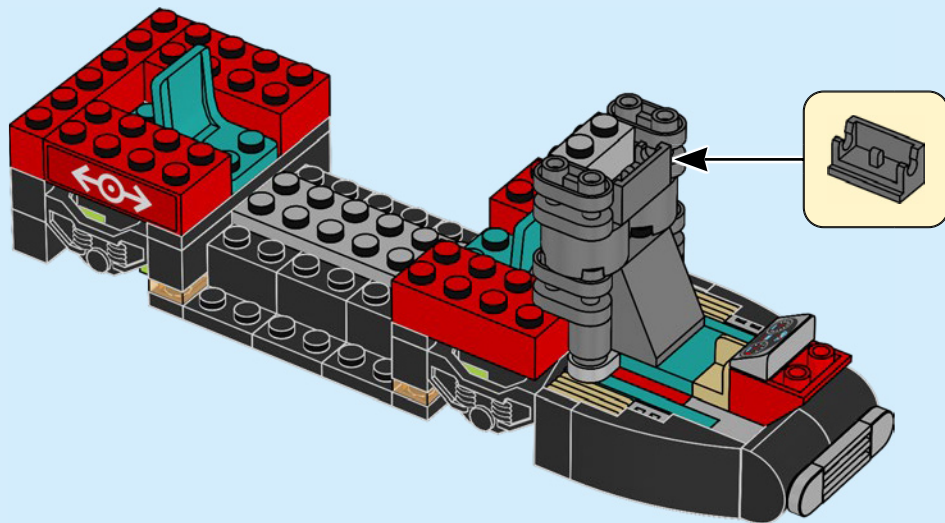

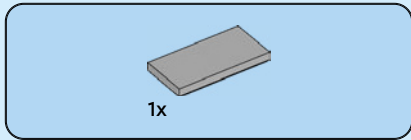

44

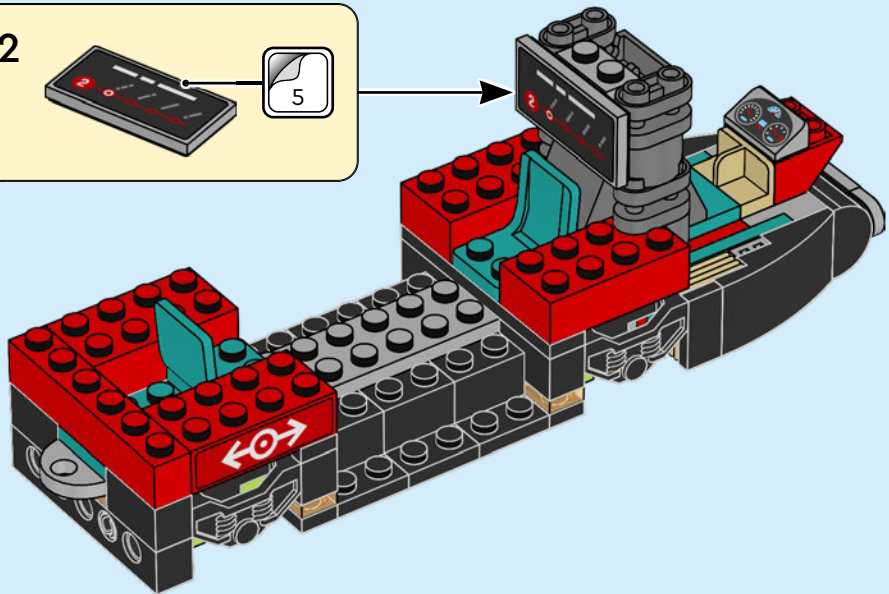



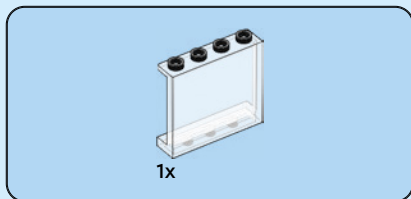

45

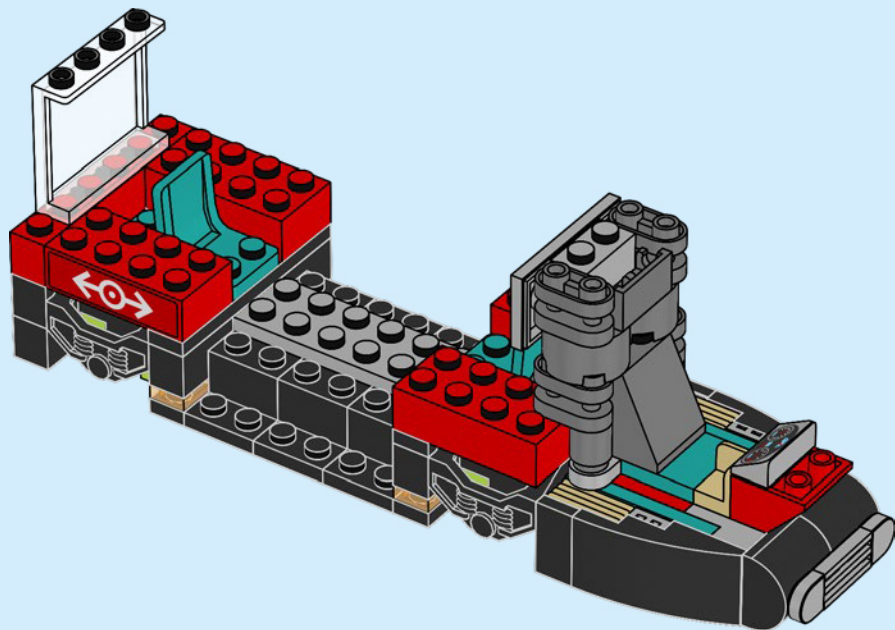

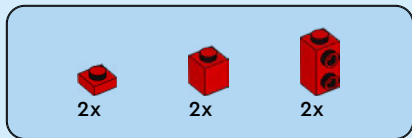

46

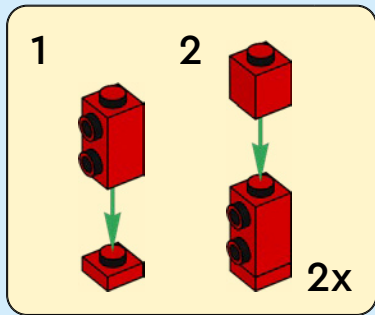
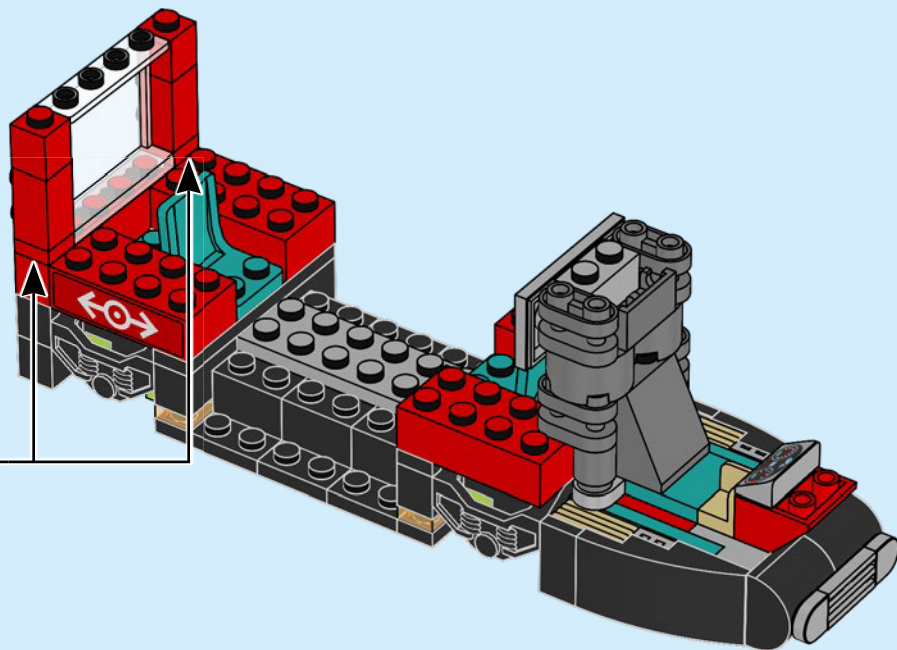

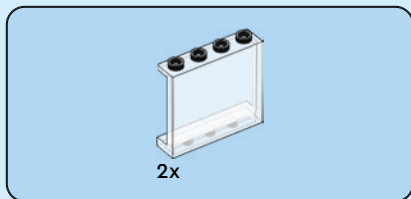

47

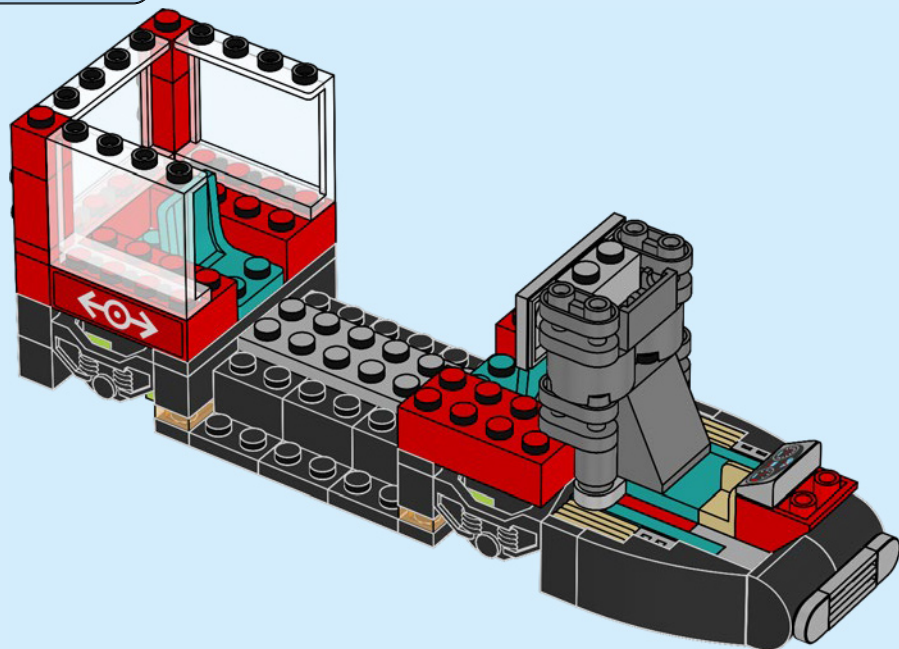

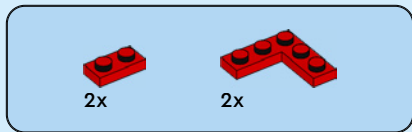

48

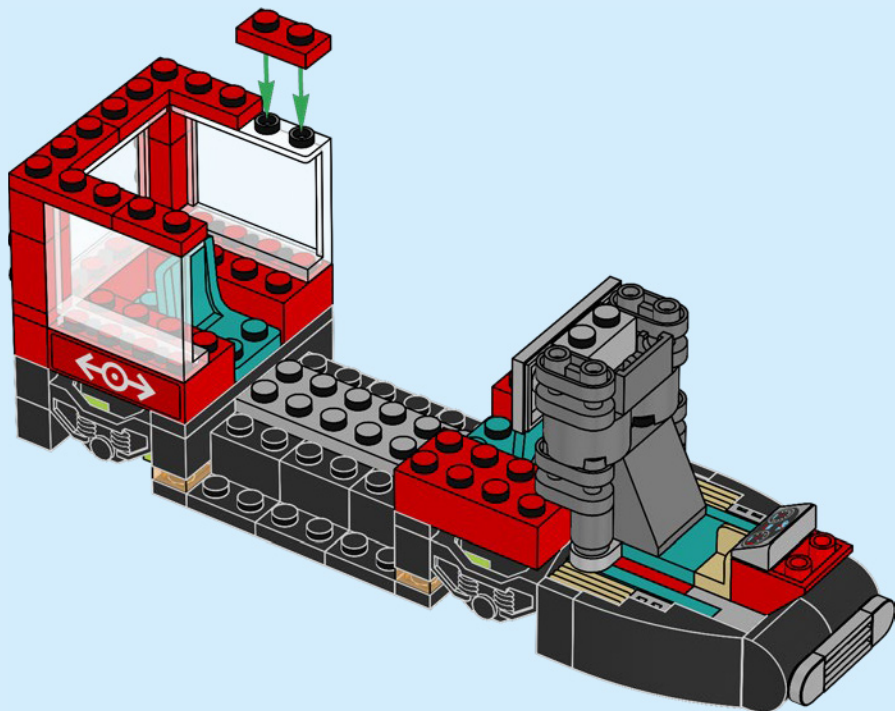

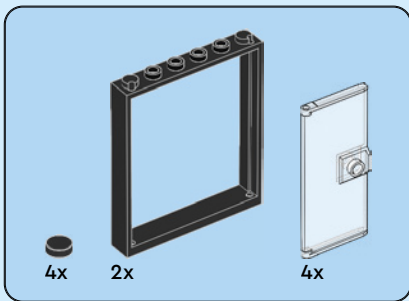
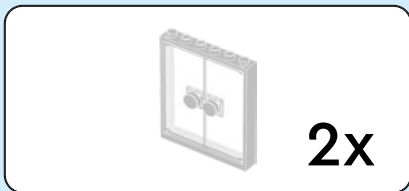

49

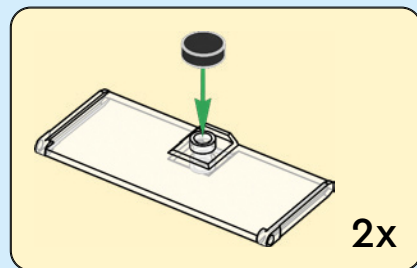

1

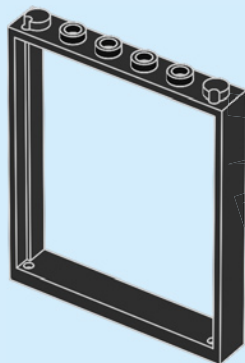

2

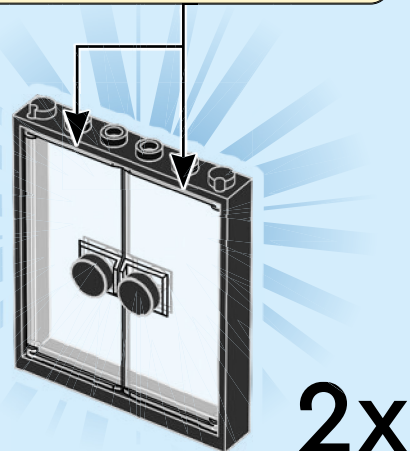

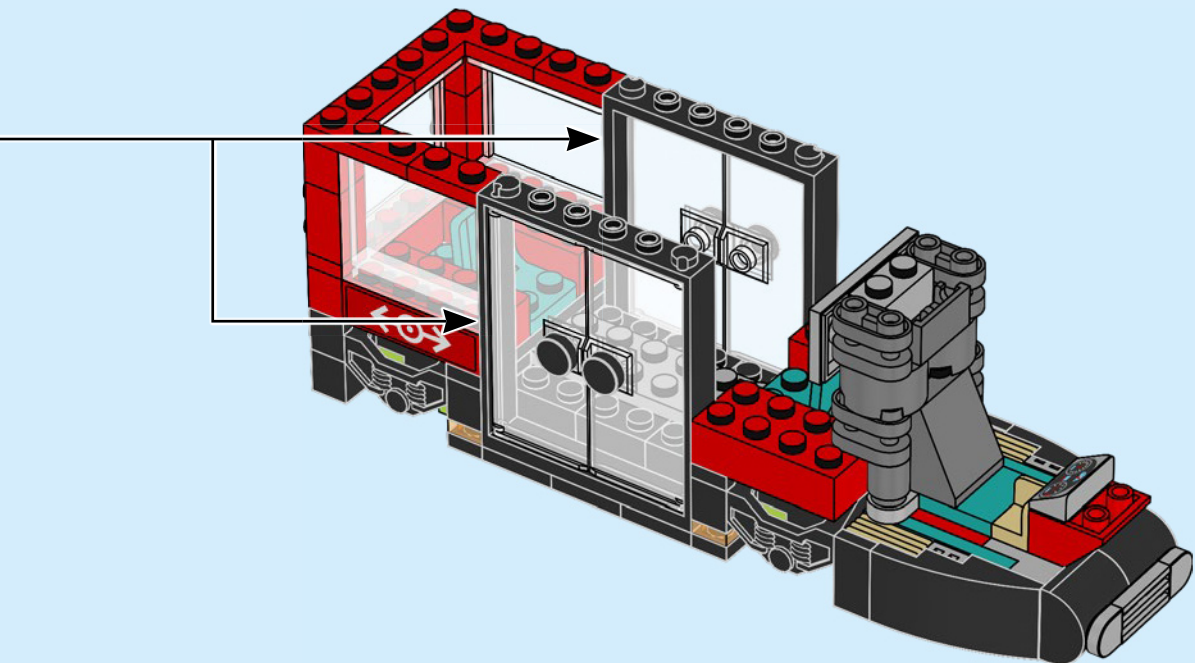

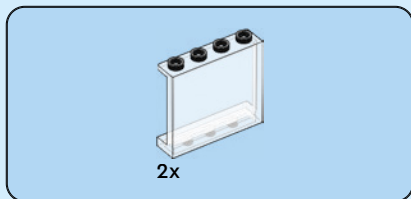

50

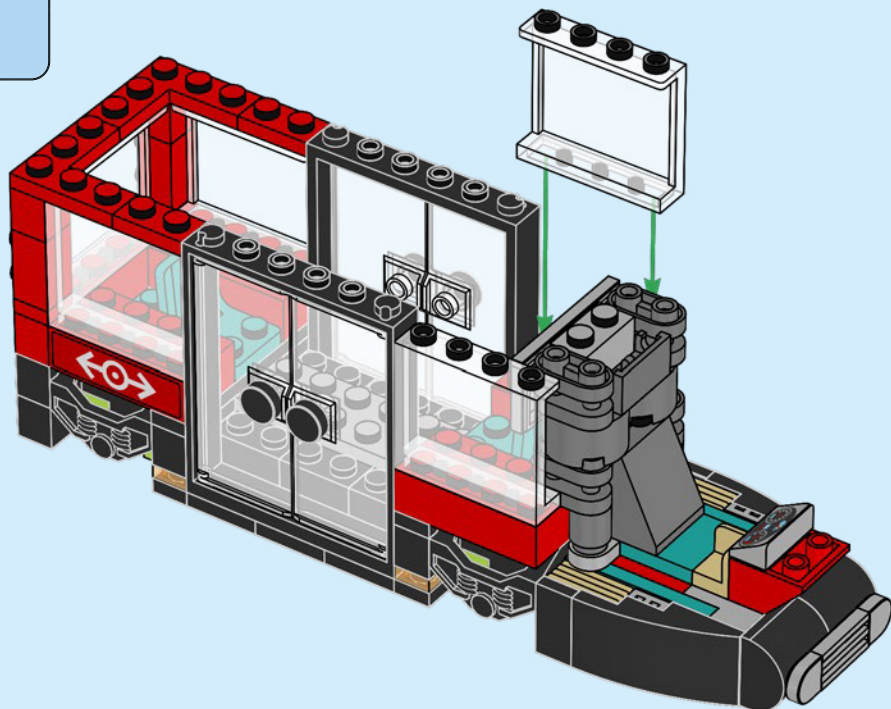



2x



2x

# 51

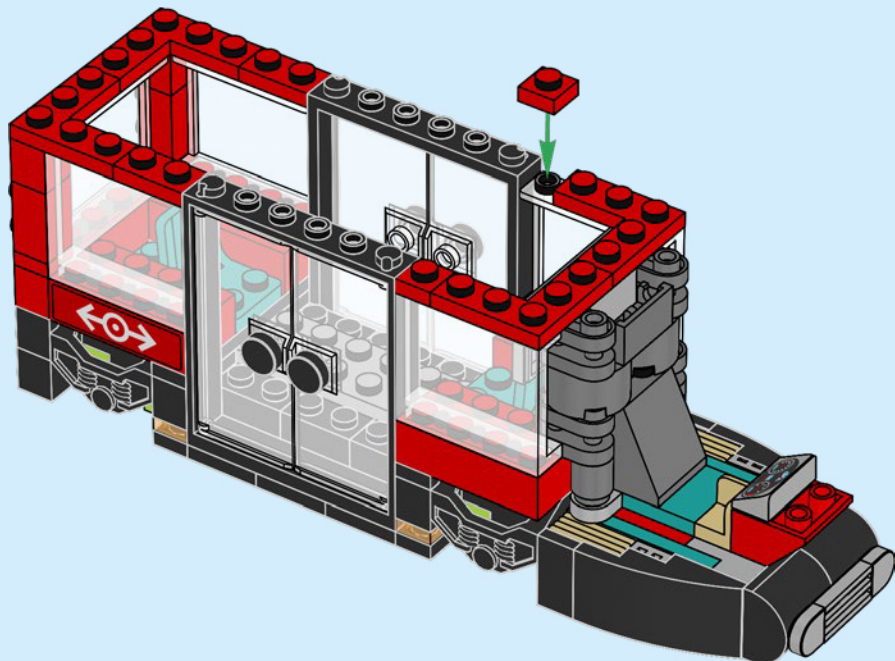





1x

52

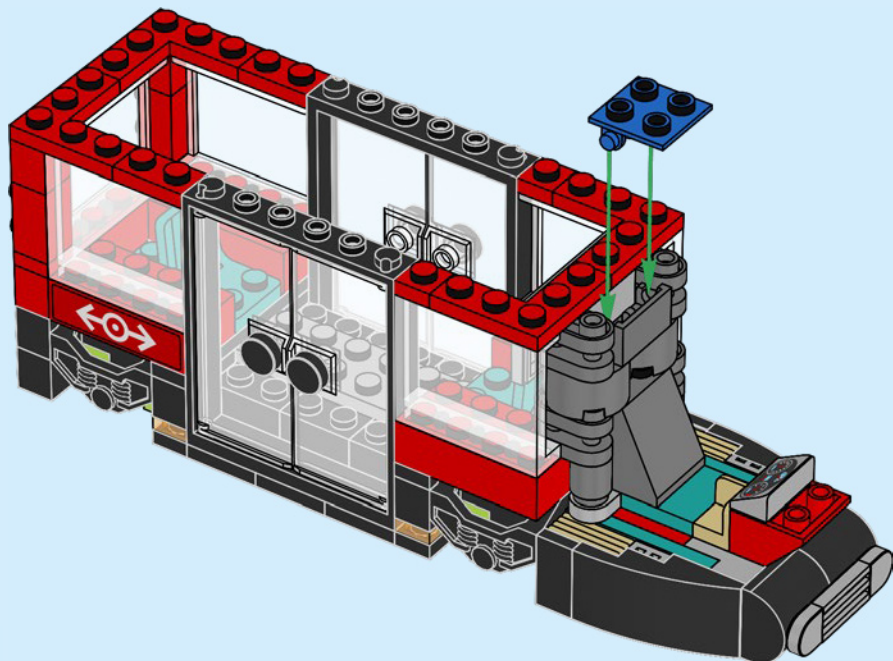



1x

53

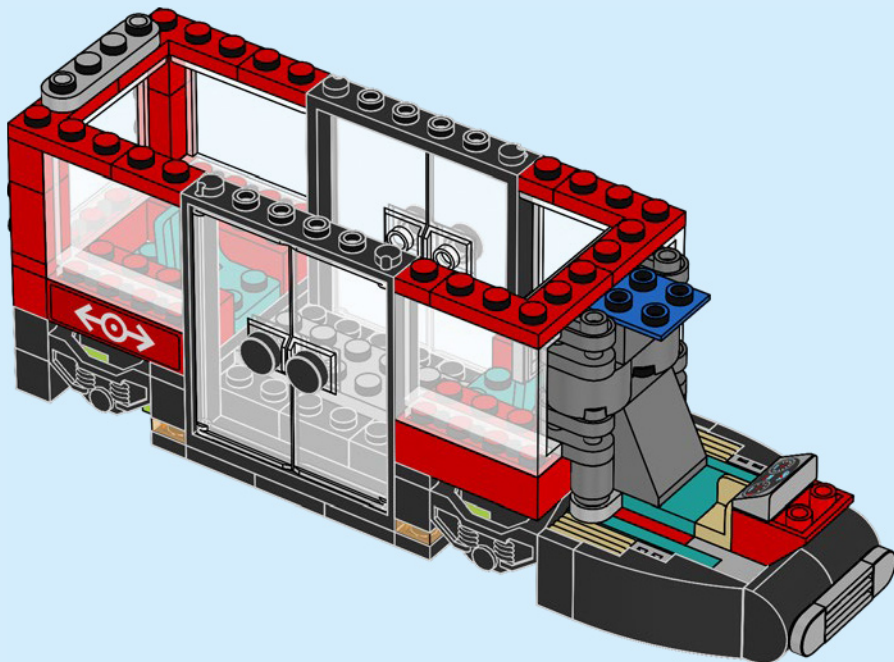

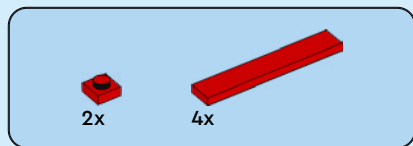

54

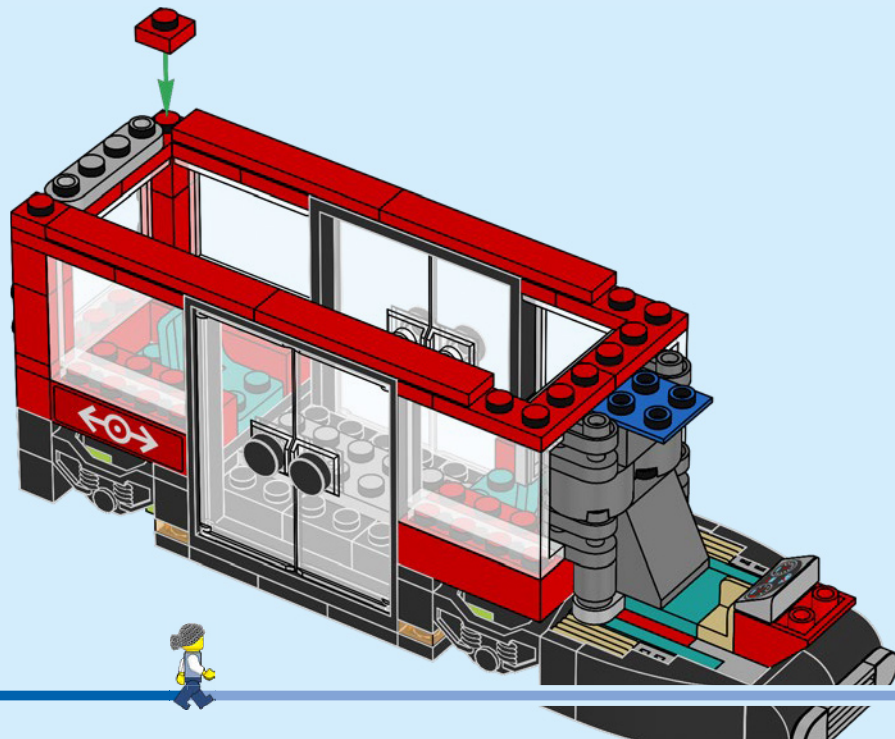

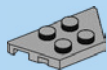

1x



2x

55

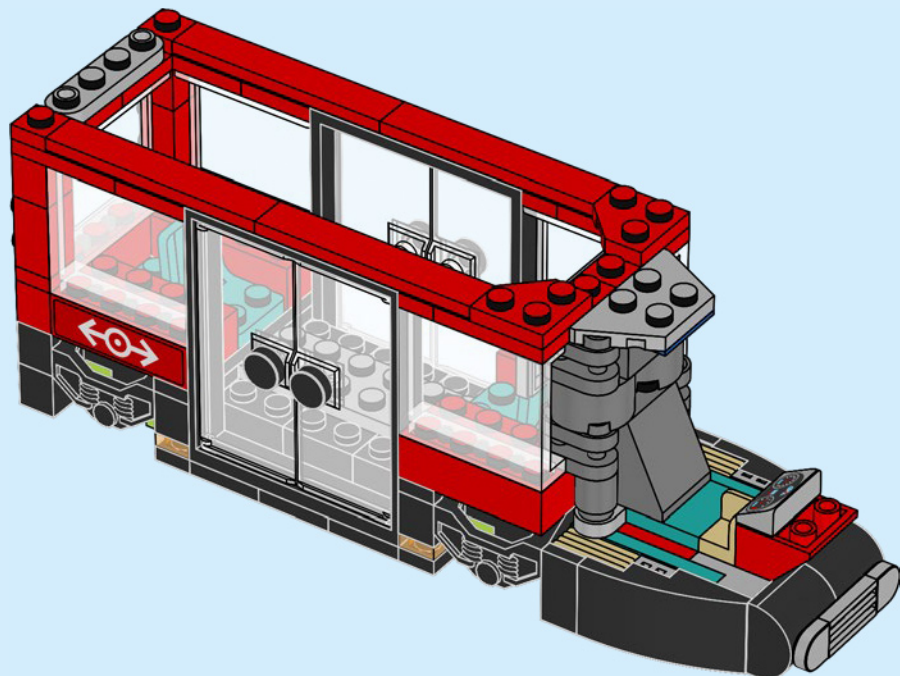



1x



2x

# 56

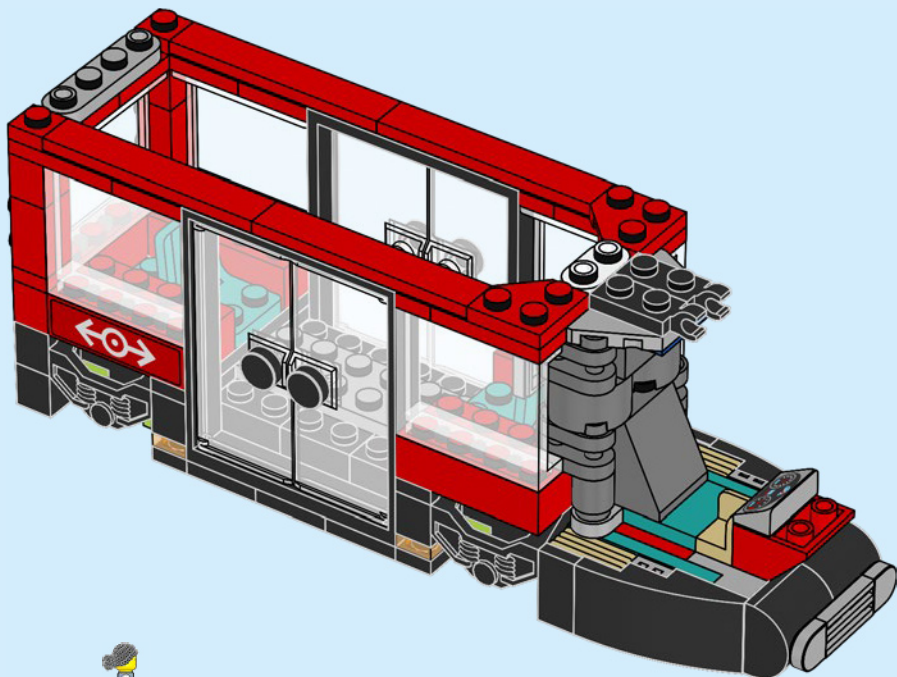

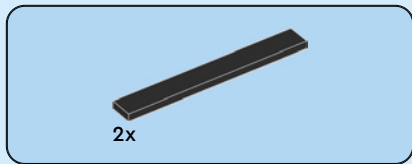

57

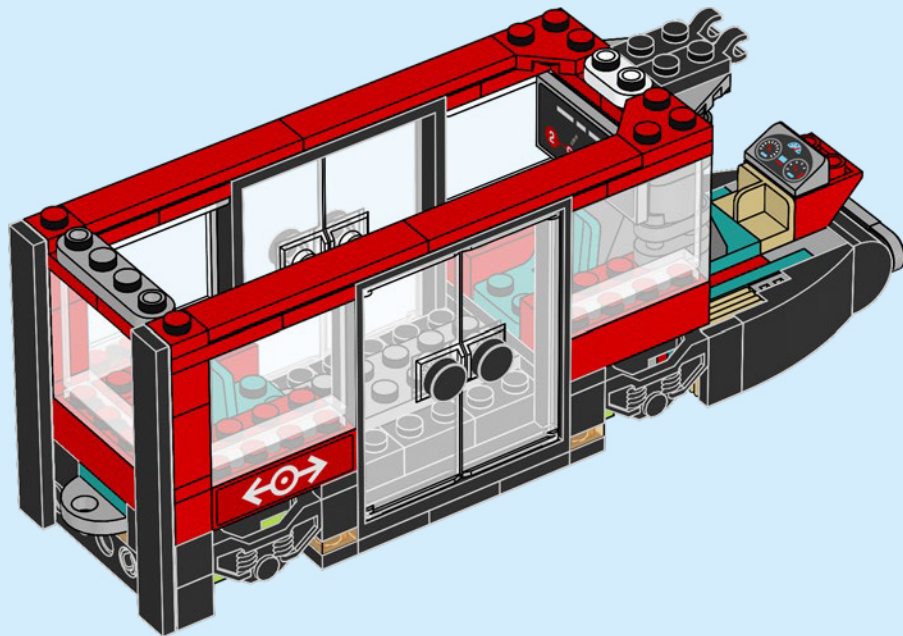

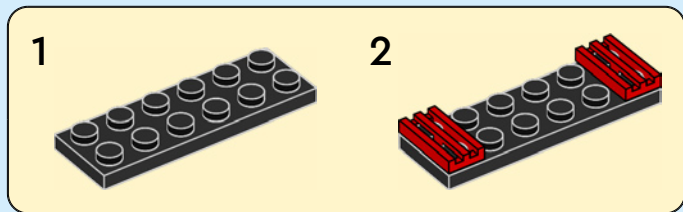
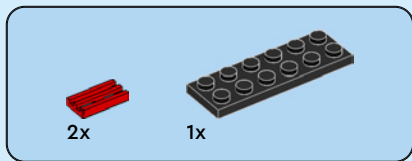

58

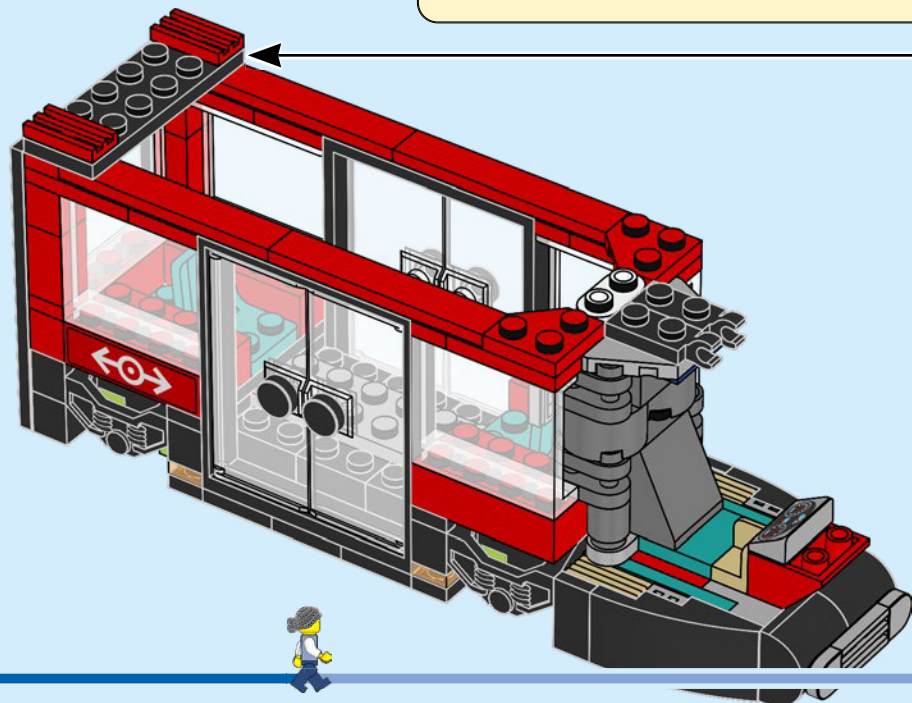

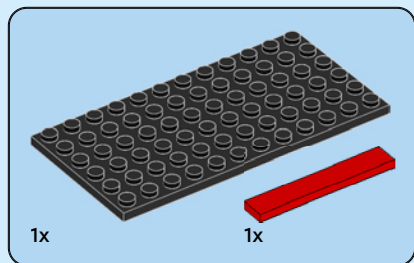

59

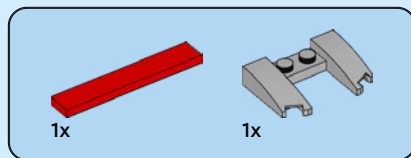
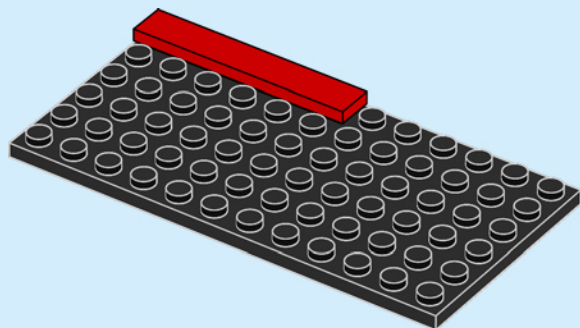

60

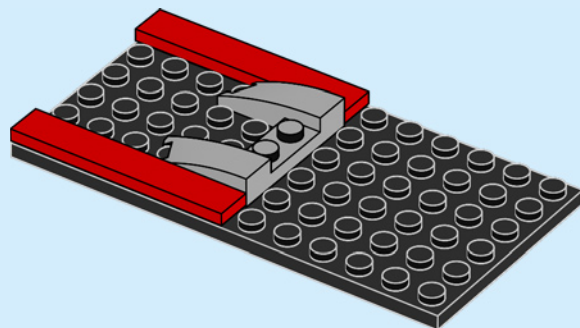



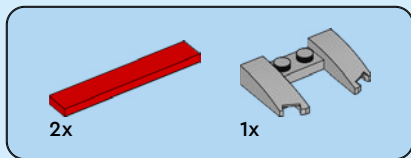

61

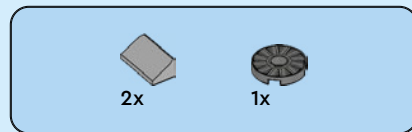
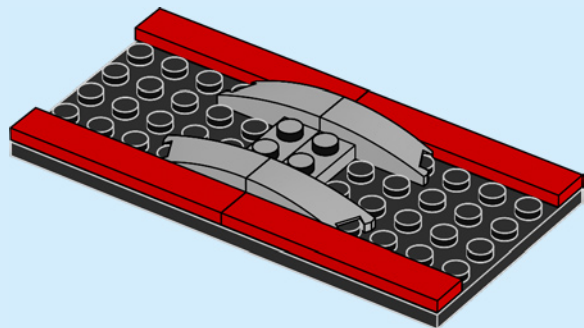

62

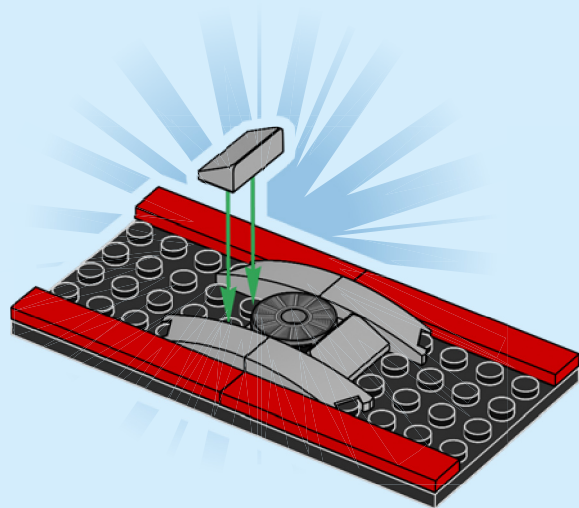

63

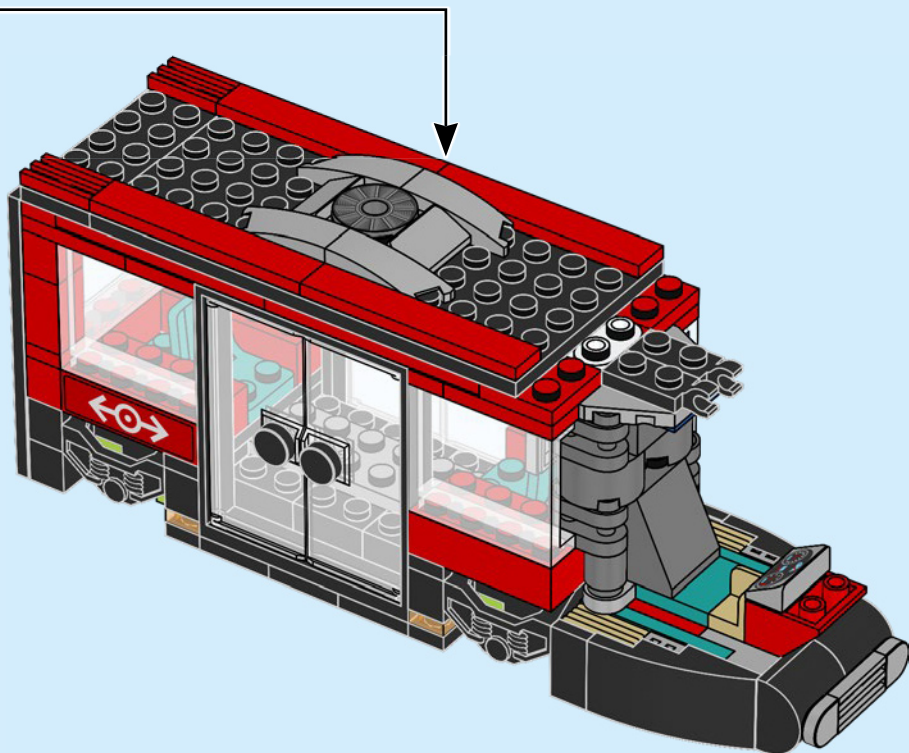



2x

64

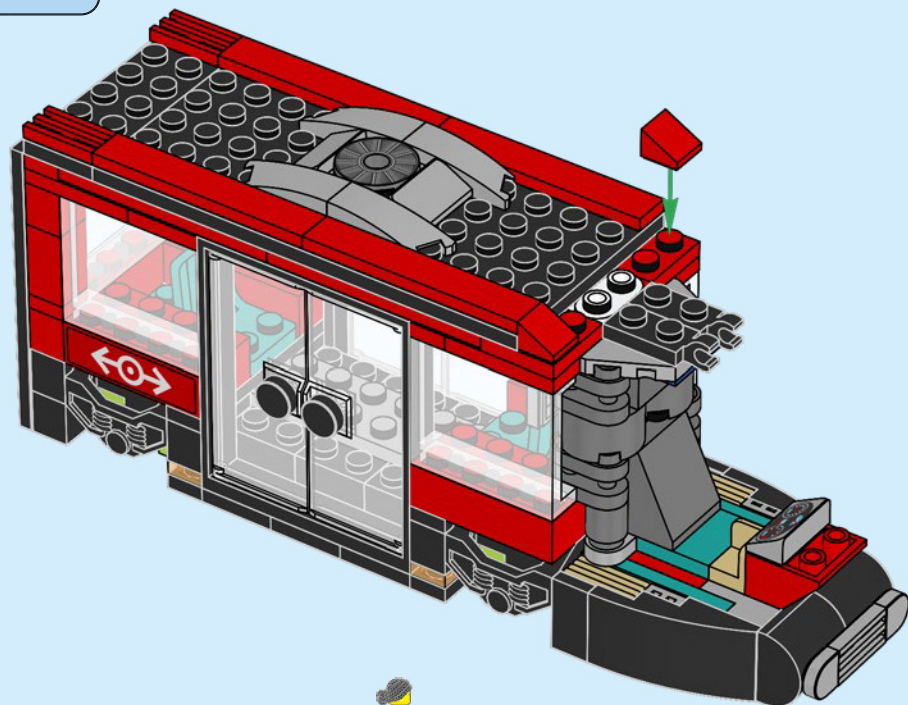

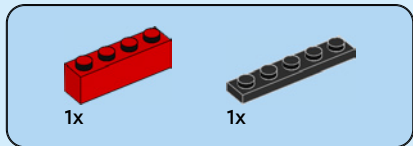
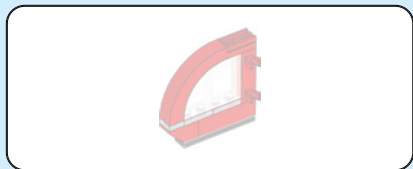

65

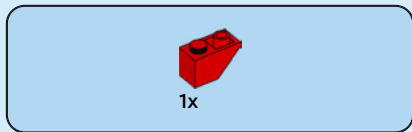
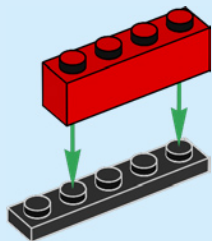

66

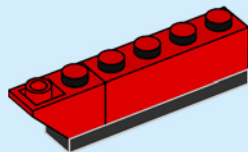

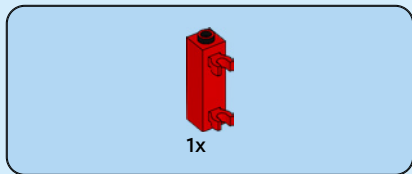

67

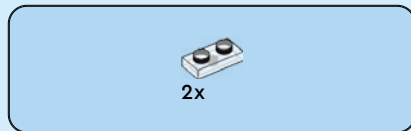
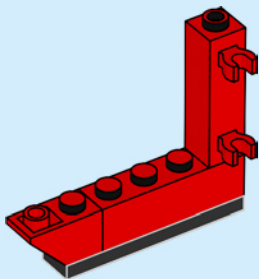

68

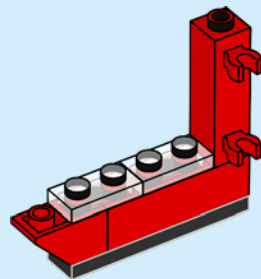

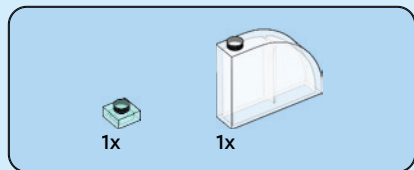

69

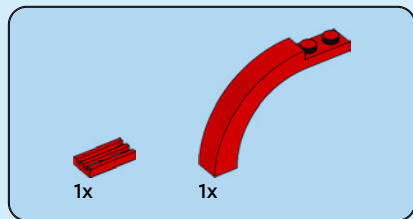
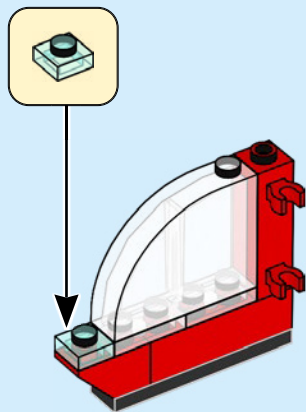

70

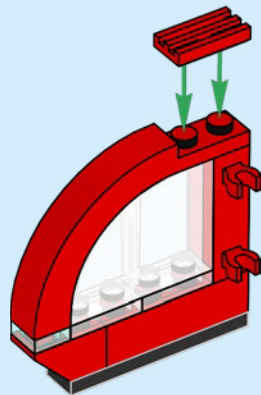

71

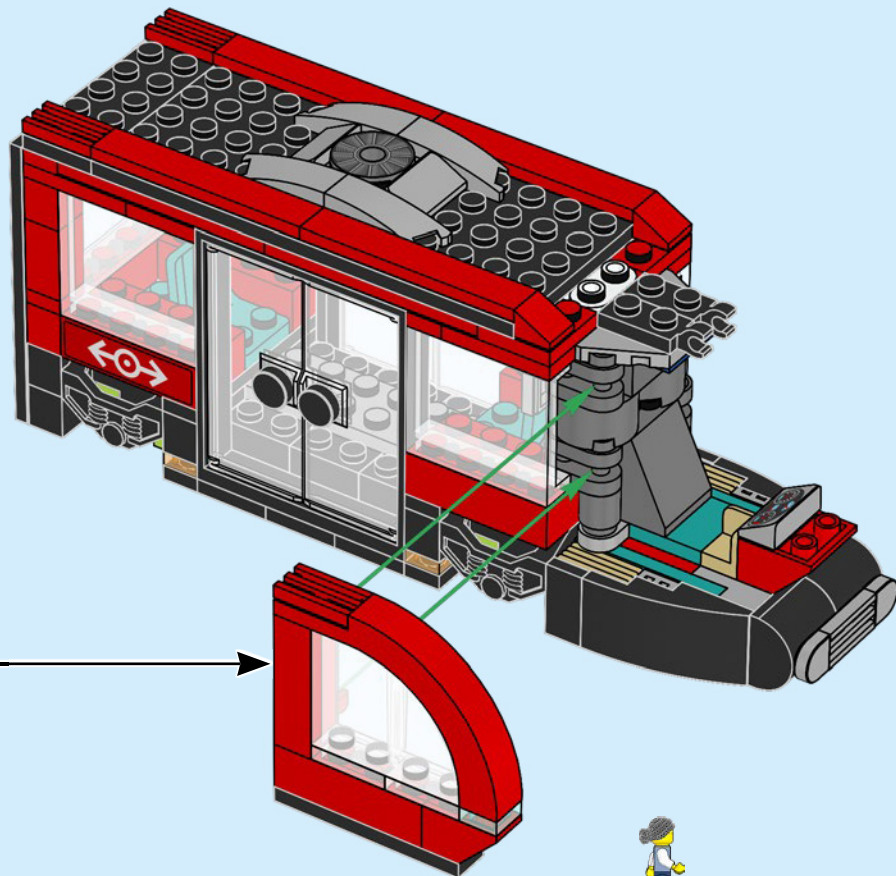

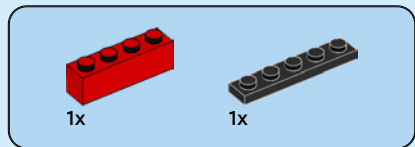

72

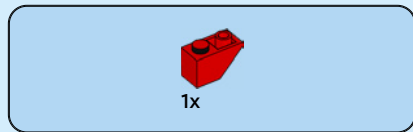
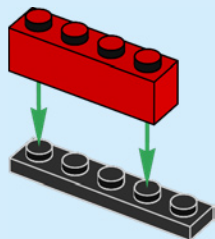

73

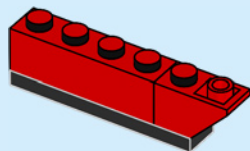



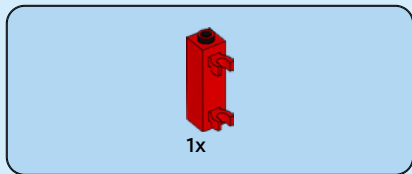

74

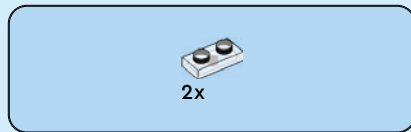
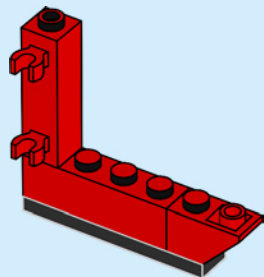

75

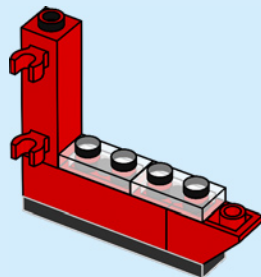

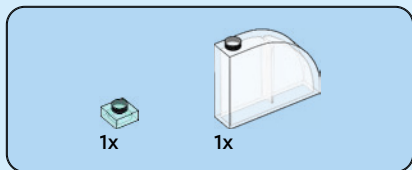

76

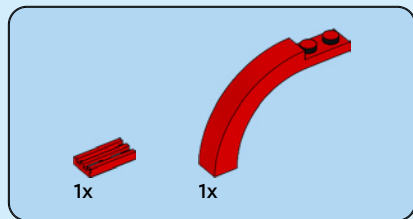
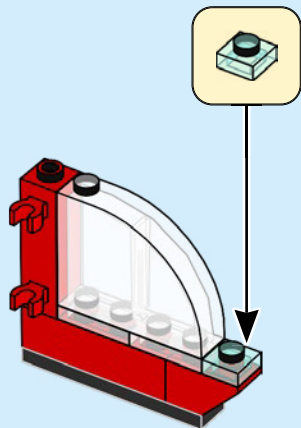

77

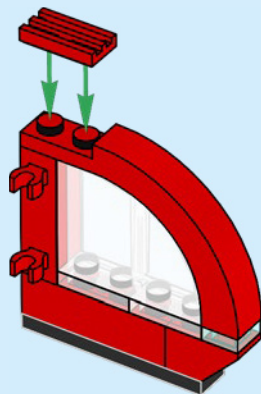

78

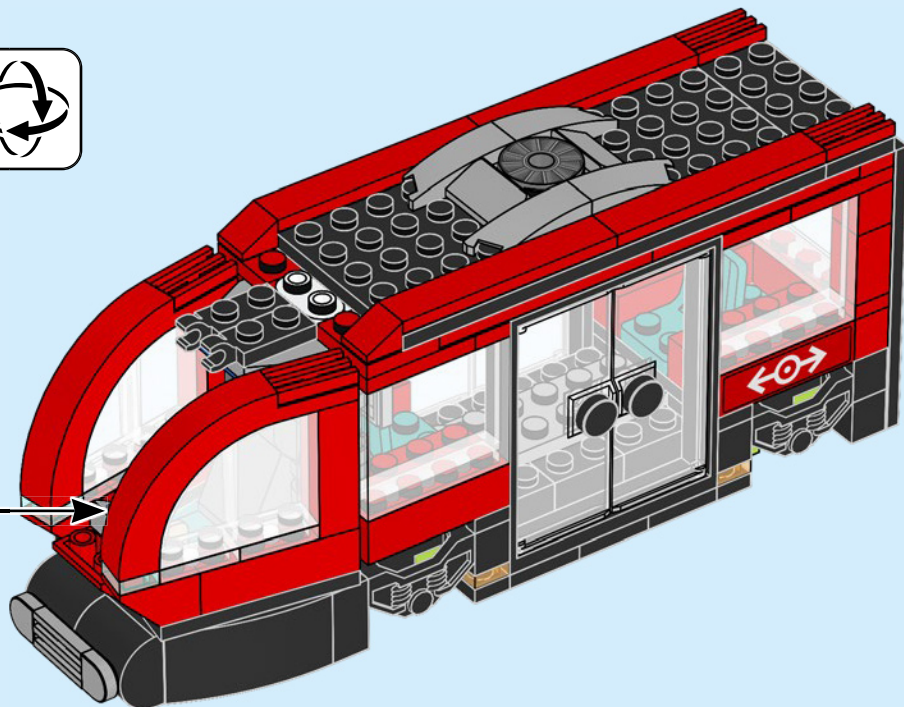



1x

79

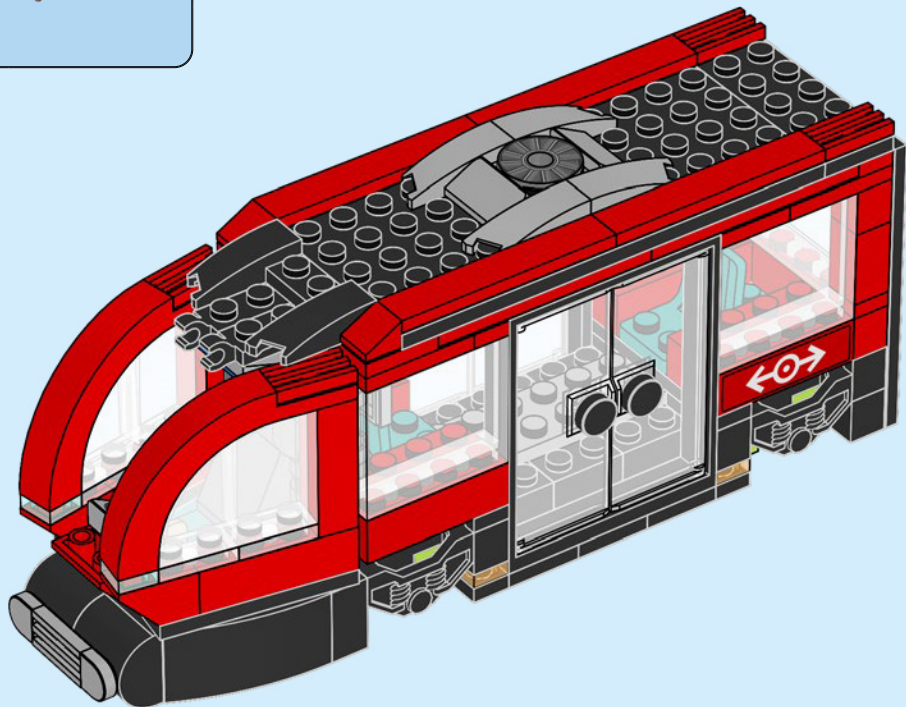



1x

80

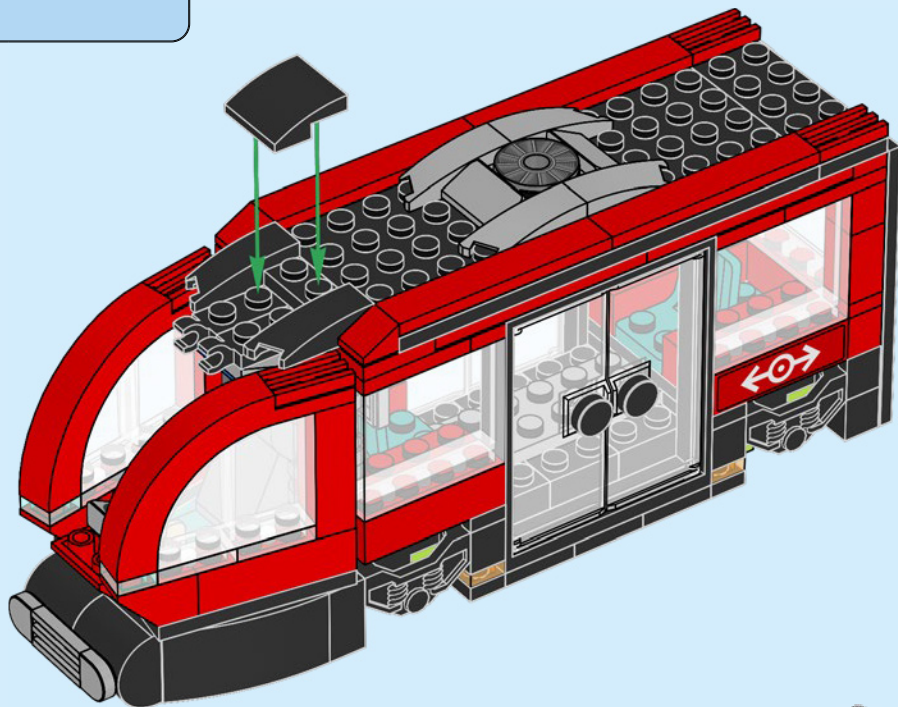



1x

81

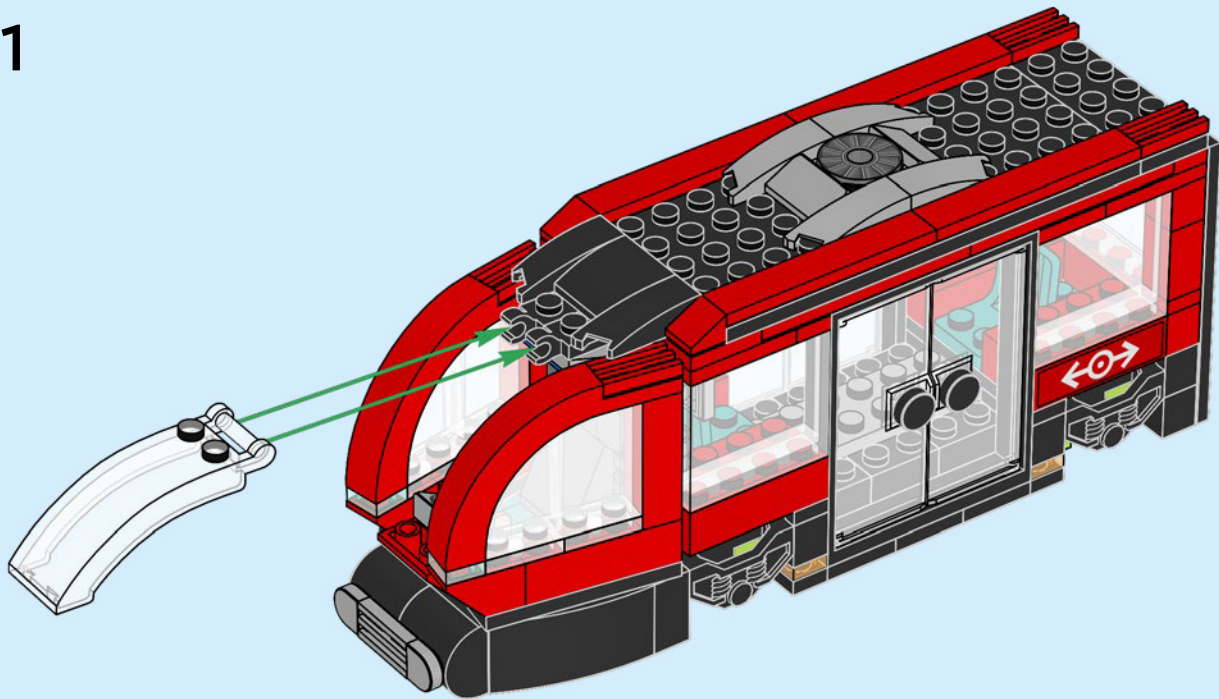

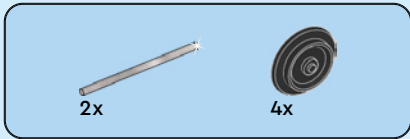

82

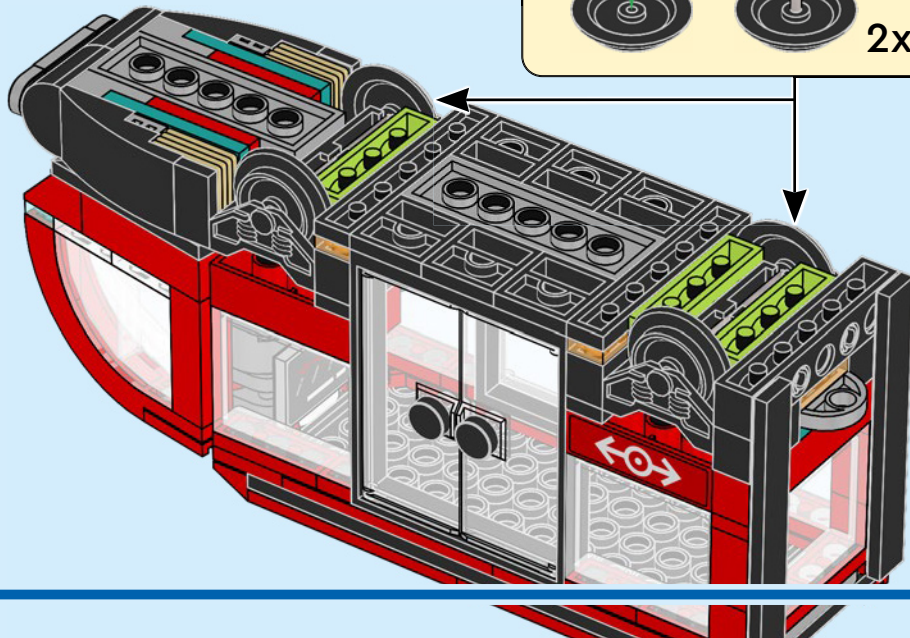
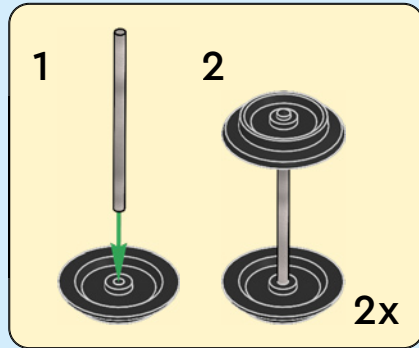

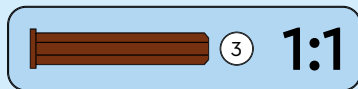
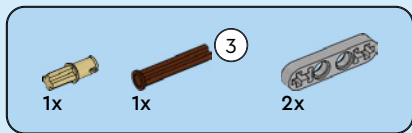

83

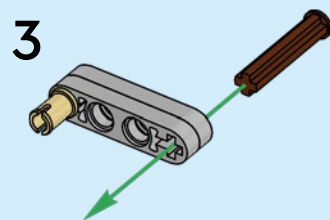
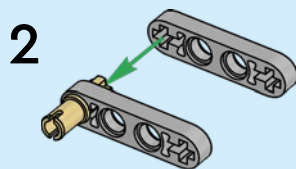
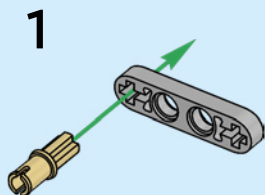



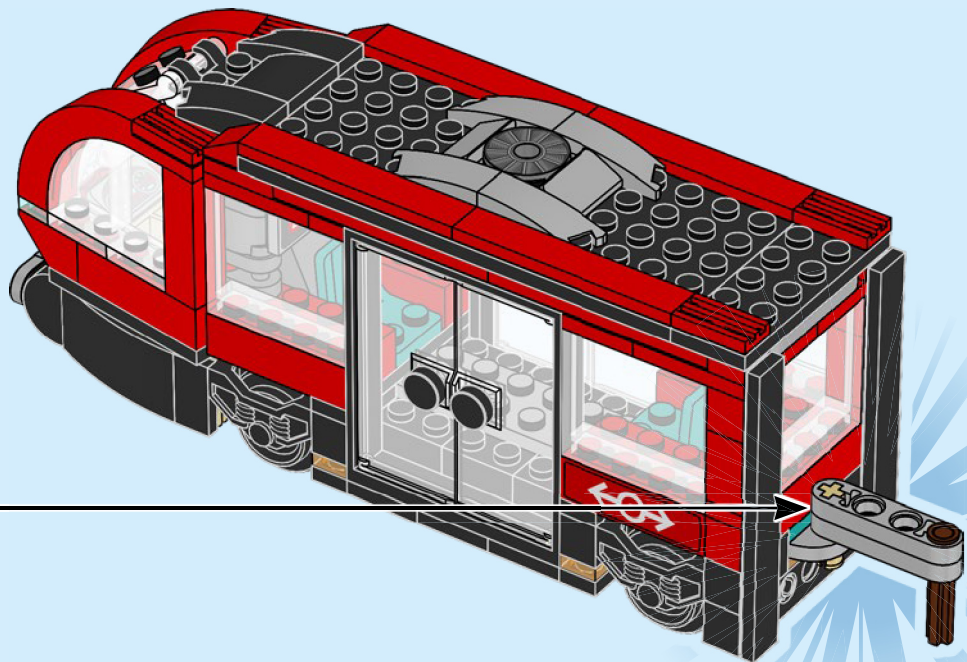

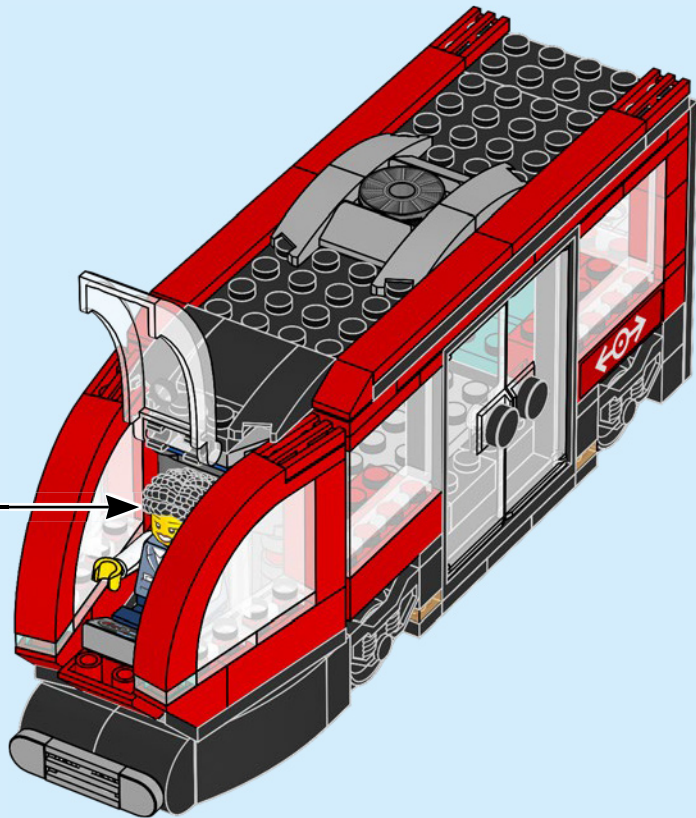

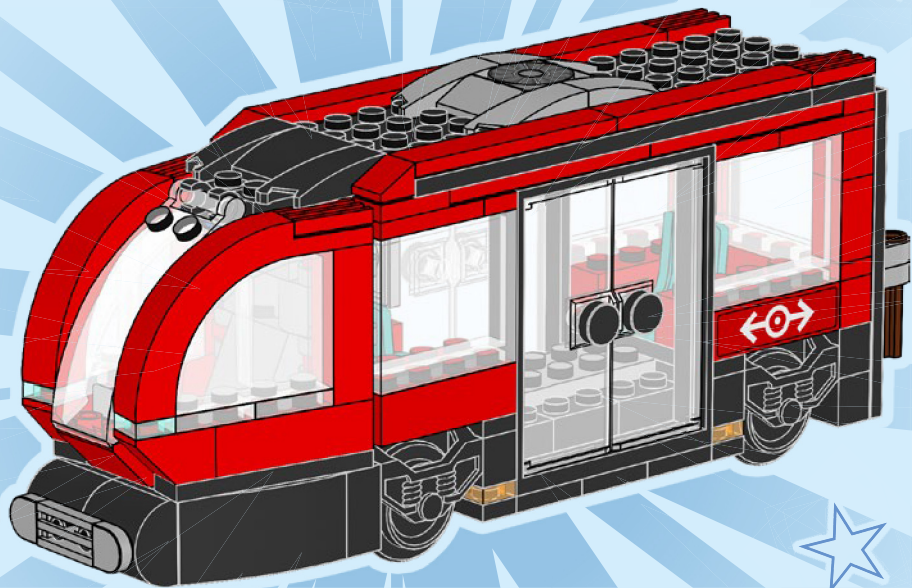



# CITY

LEGO and the LEGO logo are trademarks of the LEGO Group.  
©2024 The LEGO Group. 6532124

60409



60407



60420



60408

