



# CREATOR™

# 3 IN 1

31129



3 in 1  
3 en 1  
3 em 1  
3 az 1-ben  
Trīs vienā  
3合1

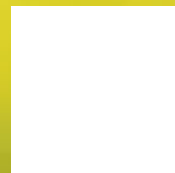



Check for compatibility  
Kompatibilität prüfen  
Vérifier la compatibilité  
Controlla la compatibilità  
Comprueba tu compatibilidad  
Verificar a compatibilidade  
Ellenőrizd a kompatibilitást  
Pārbaudīt saderību  
检查兼容性

[LEGO.com/devicecheck](https://LEGO.com/devicecheck)



# 乐高®拼搭指引



LEGO® Building Instructions



Download on the  
App Store



GET IT ON  
Google Play



腾讯应用宝  
安卓应用商店

Apple and the Apple logo are trademarks of Apple Inc.  
Google Play and the Google Play logo are trademarks of Google LLC.  
Tencent and the Tencent logo are trademarks of Tencent Inc.



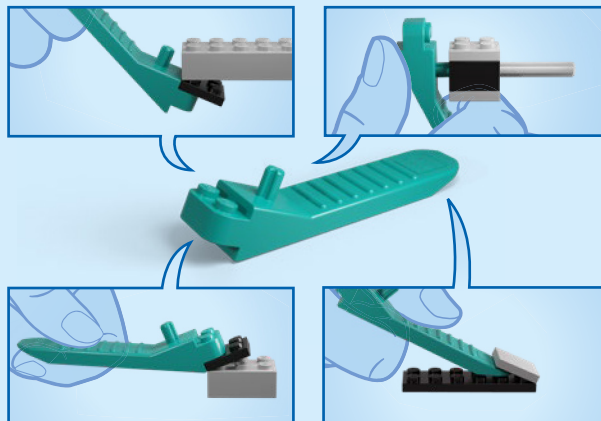



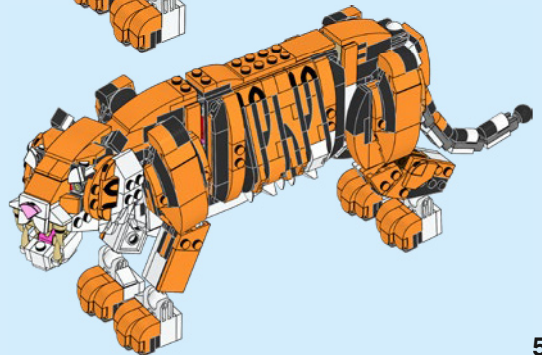
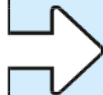
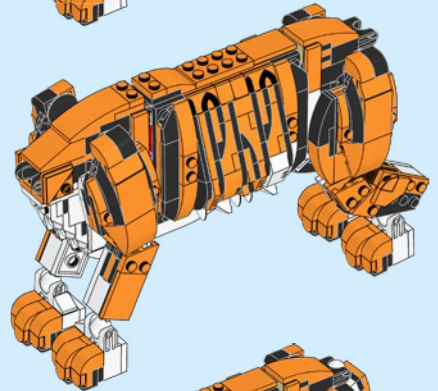
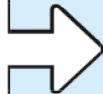
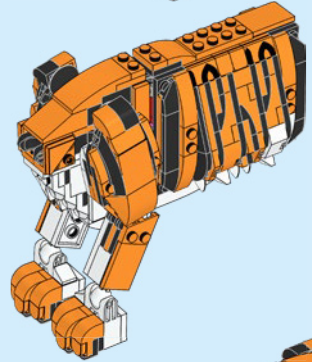
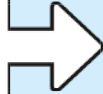
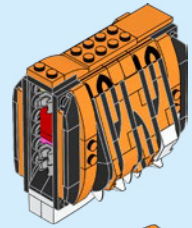
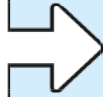

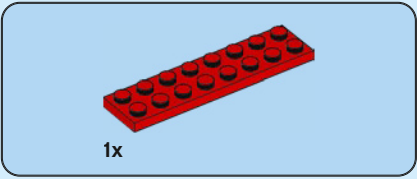
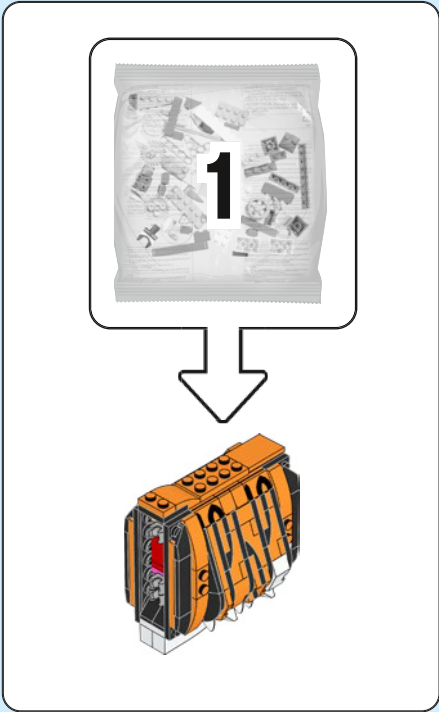
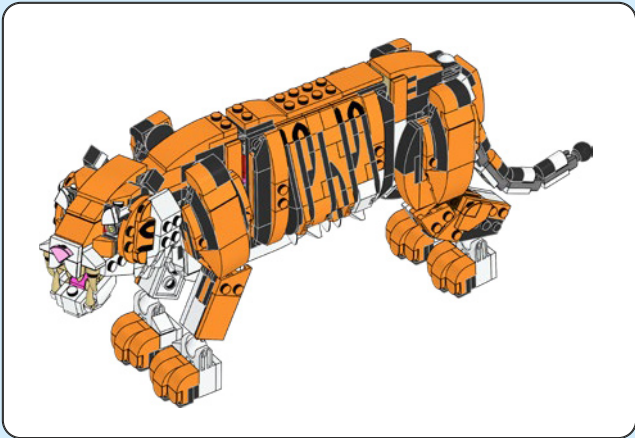

1

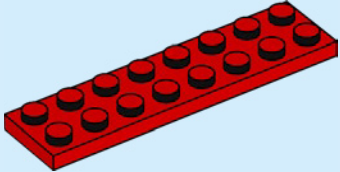

2

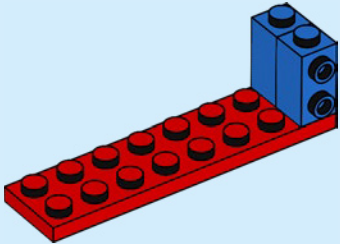



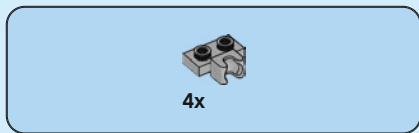

3

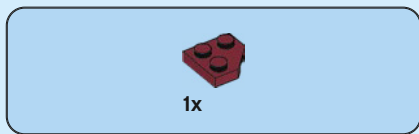
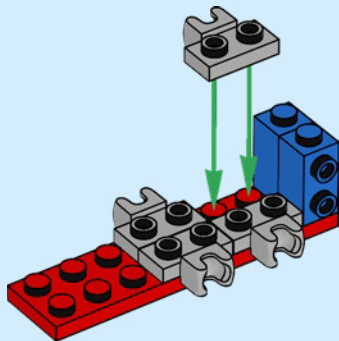

4

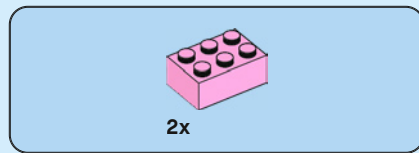
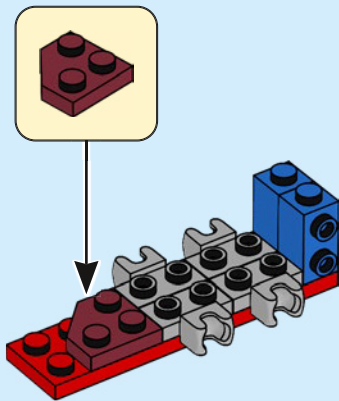

5

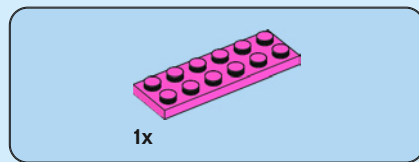
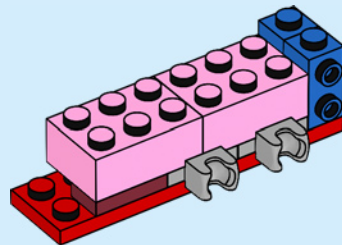

6

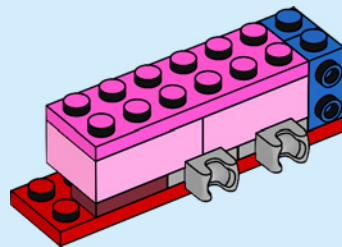



2x

7

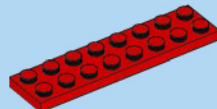
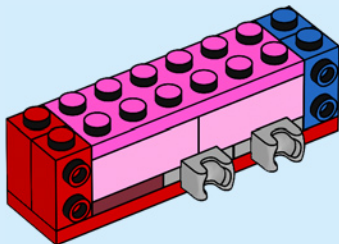

1x

8

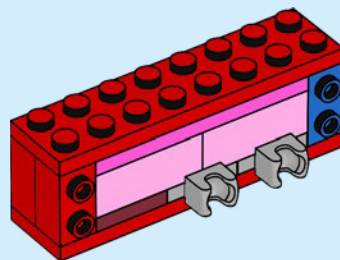

2x

9

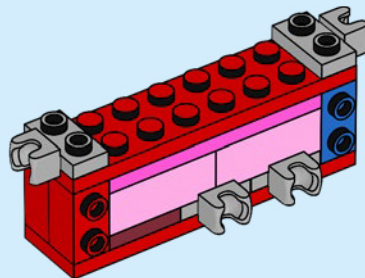





6x

10

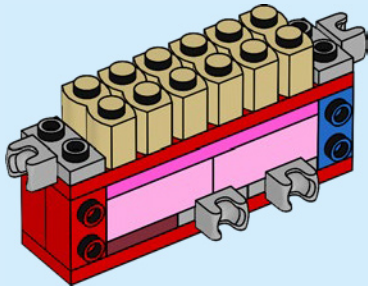

4x

11

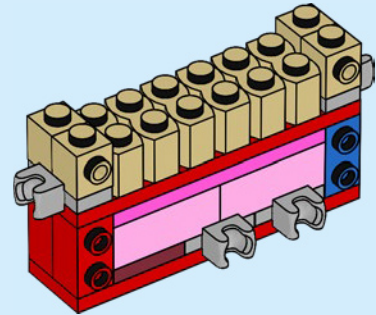

6x

12

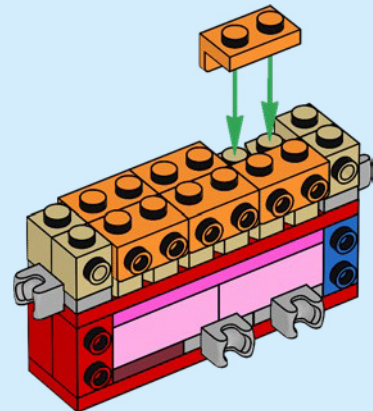

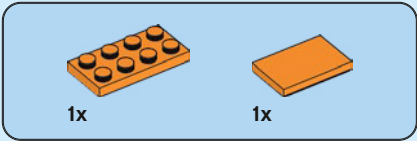

13

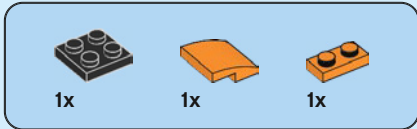
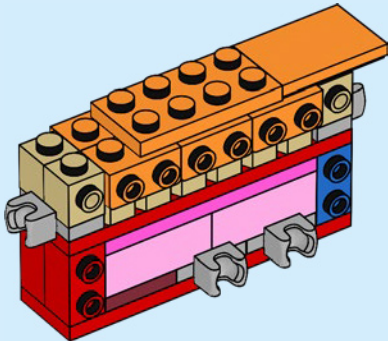

14

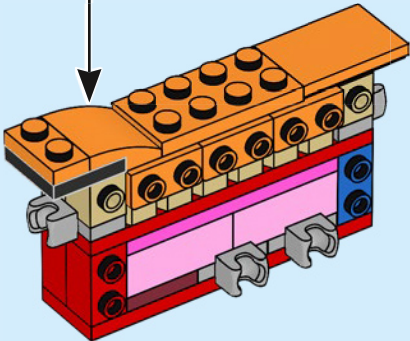

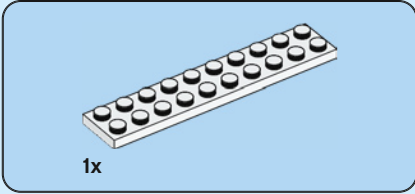
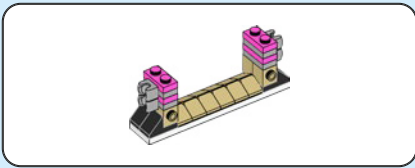

1x

15

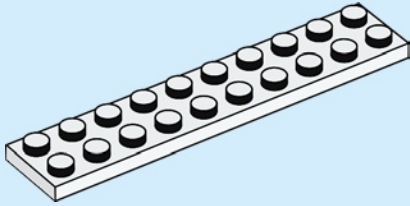

4x

16

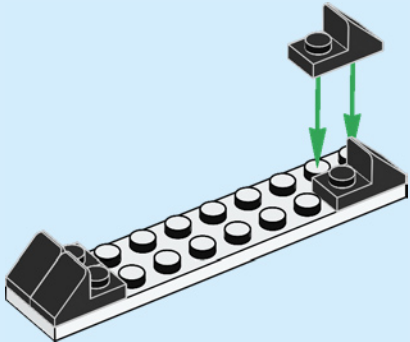

12x

17

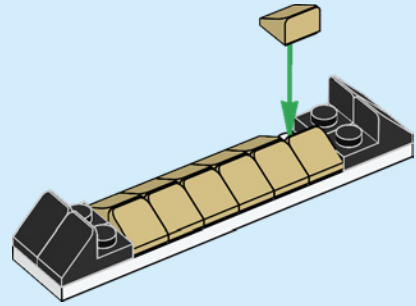

4x

18

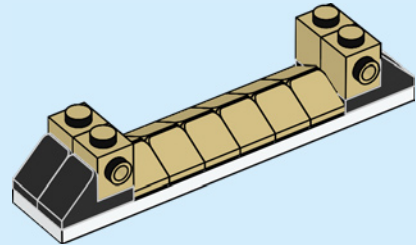



19

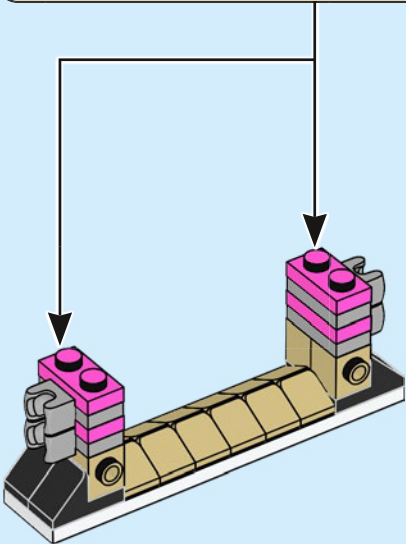
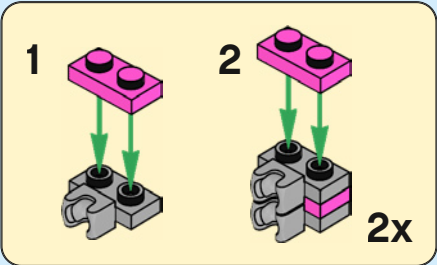

20

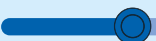
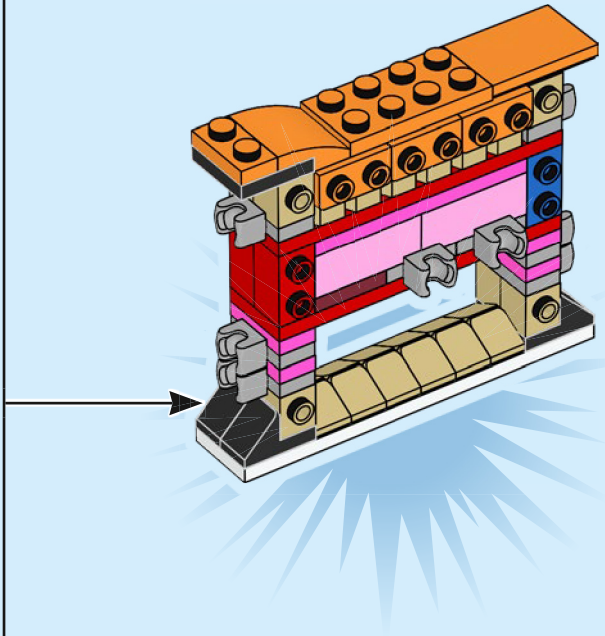



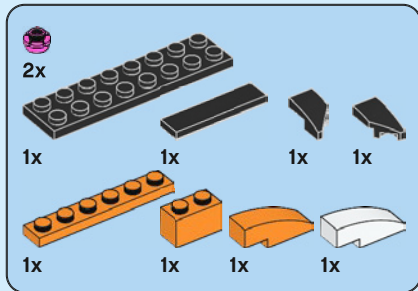

21

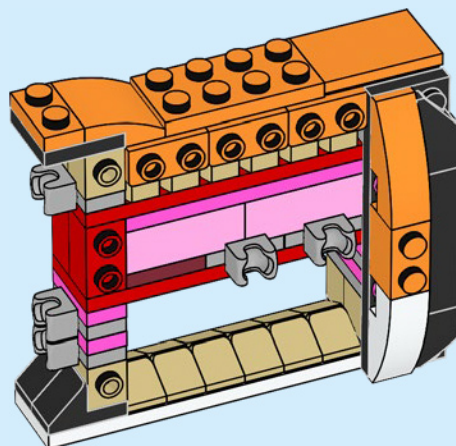
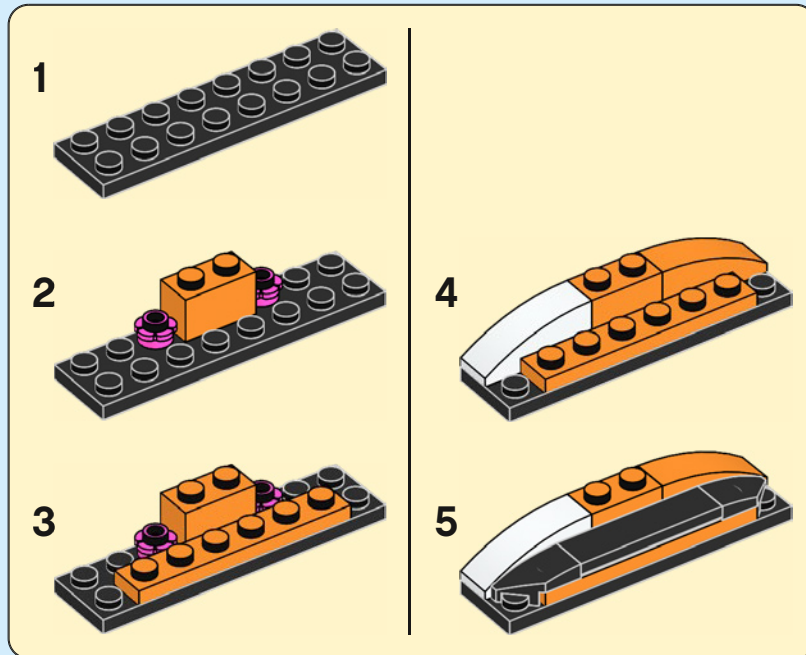



2x



2x

22

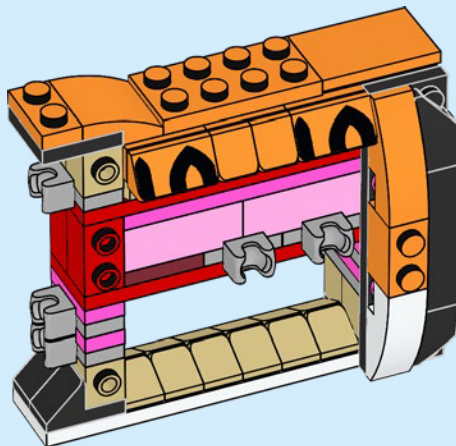

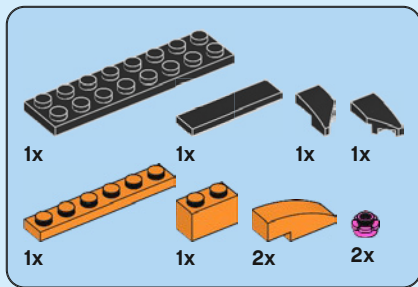

23

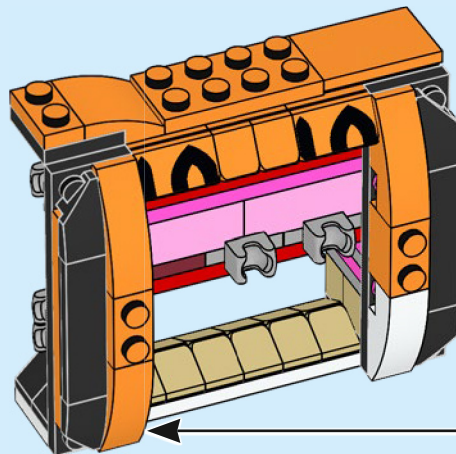
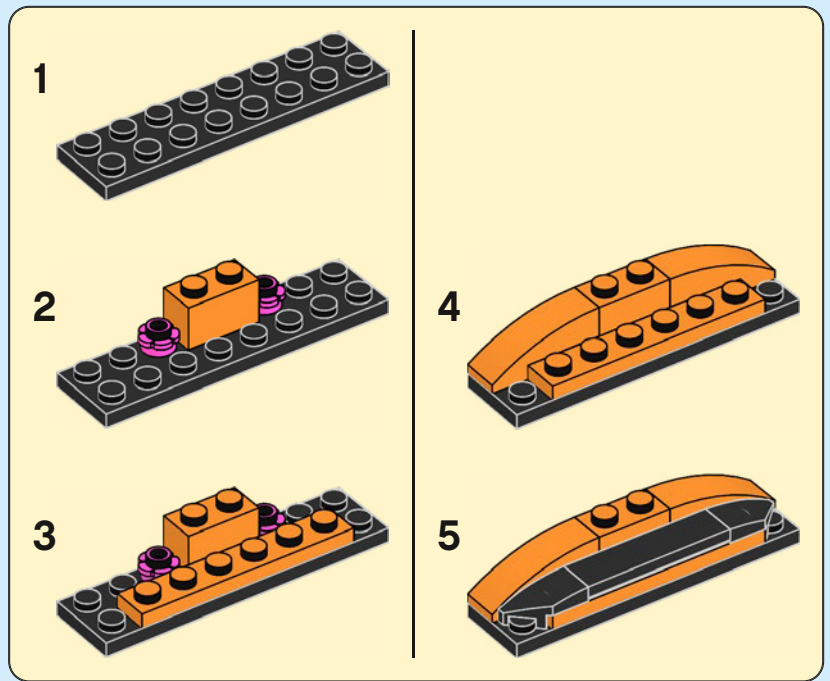

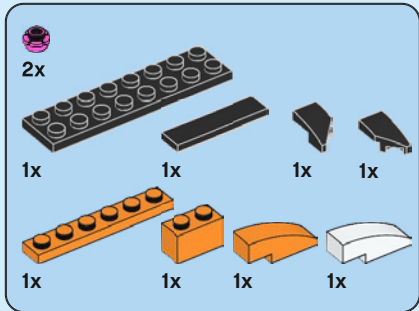

24

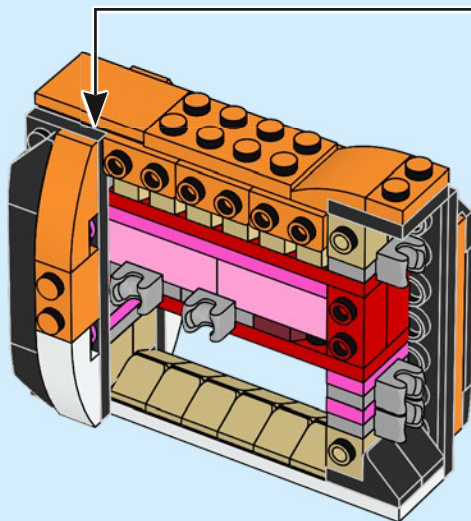
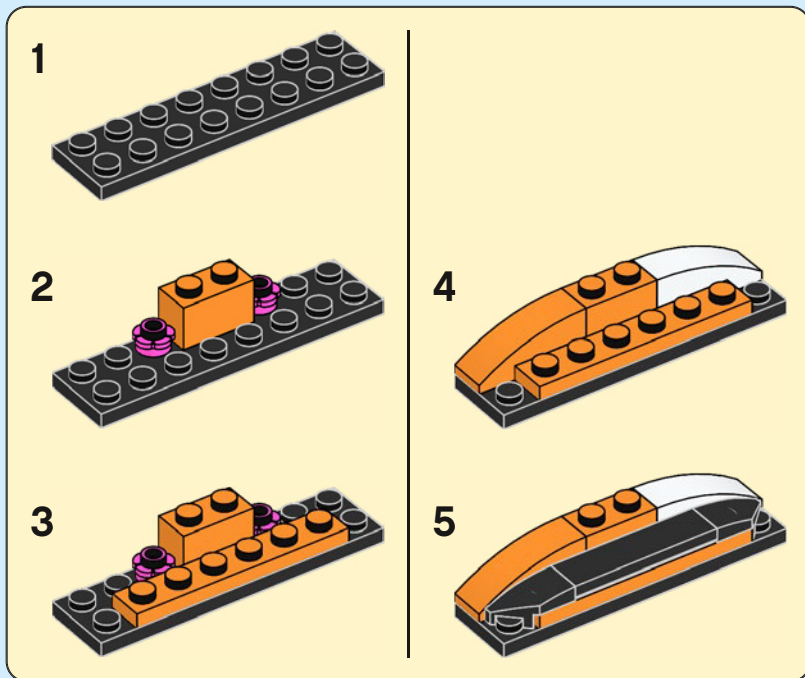





2x



2x

25

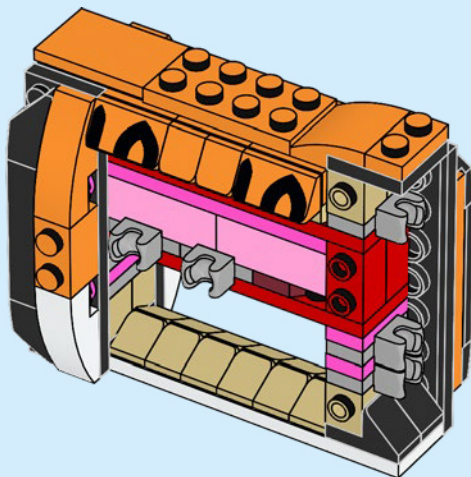

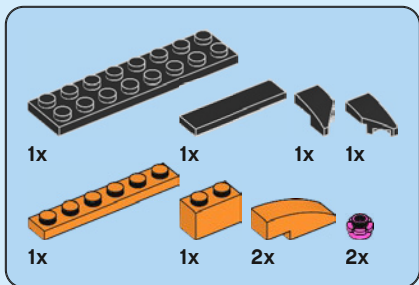

26

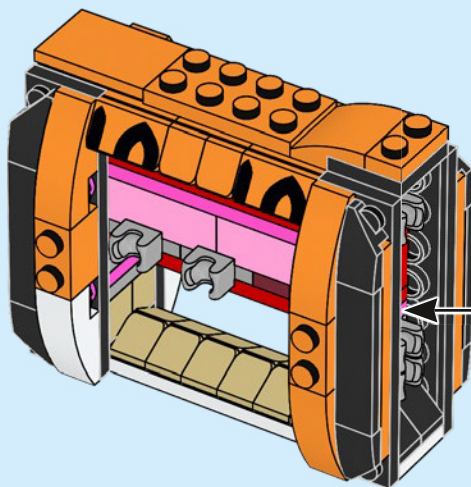
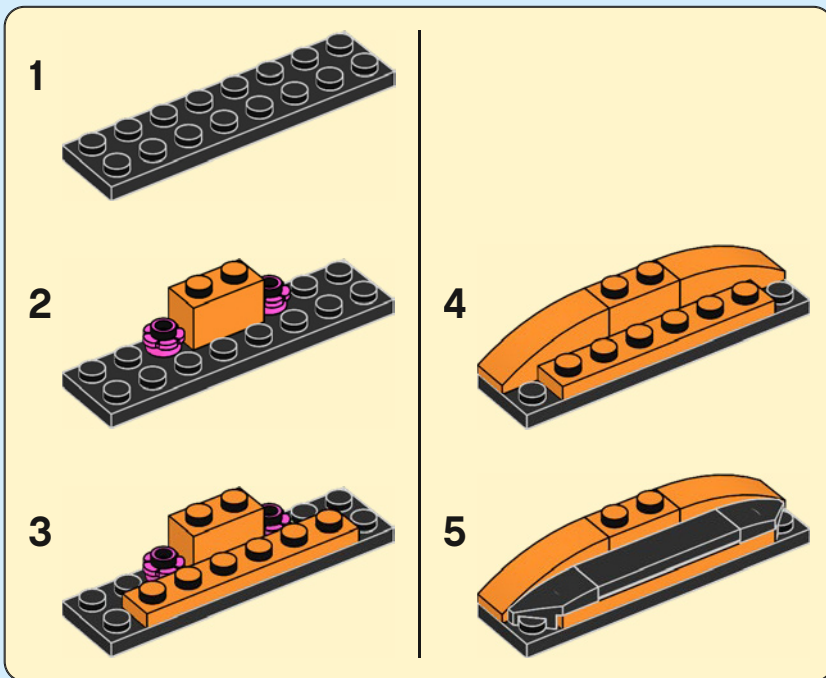

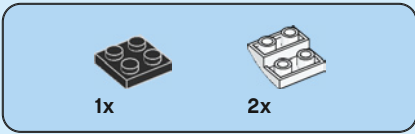

27

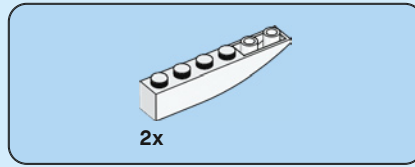
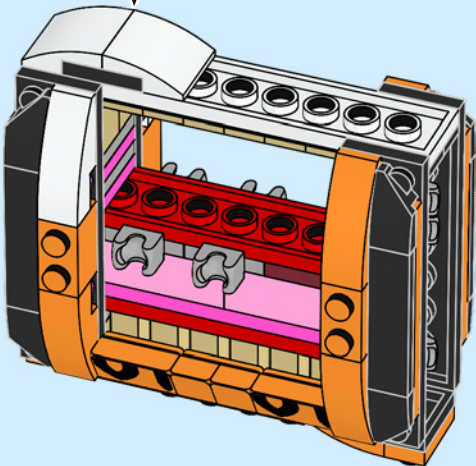
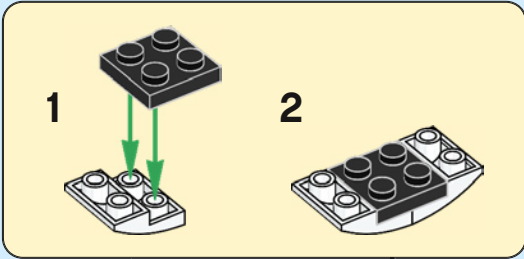

28

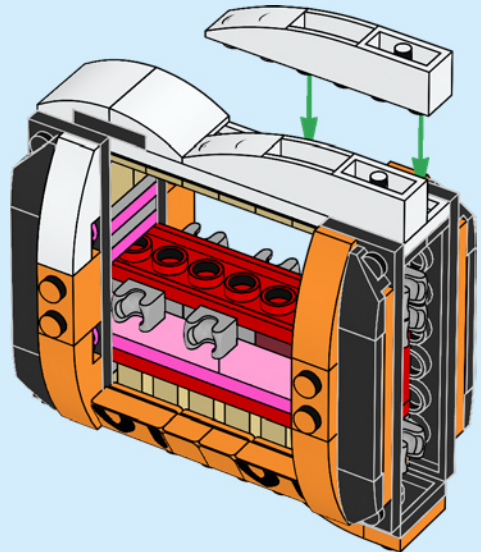

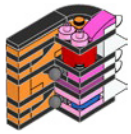

1x

# 29

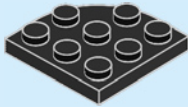
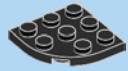

1x

# 30

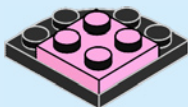

1x



1x



1x

# 31

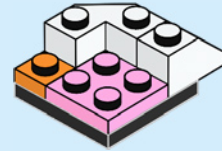

1x



1x



1x

# 32

1

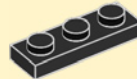

2



3

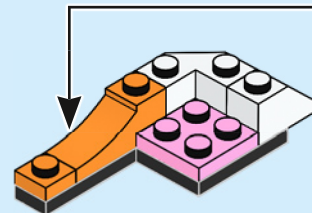
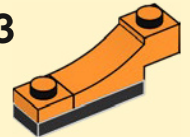



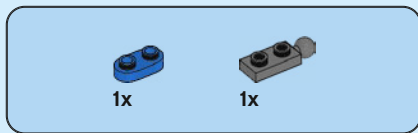

33

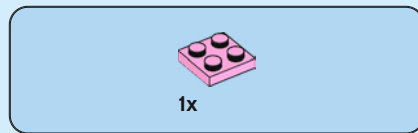
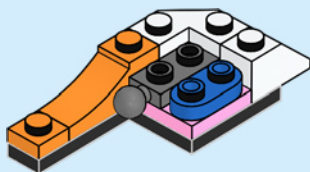

34

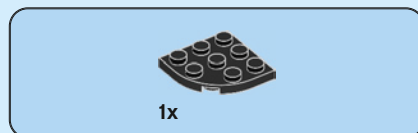
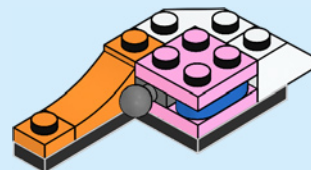

35

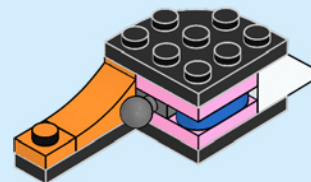

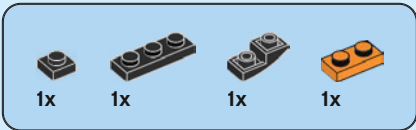

36

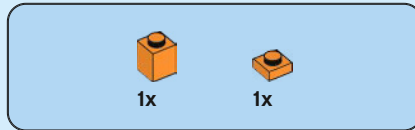
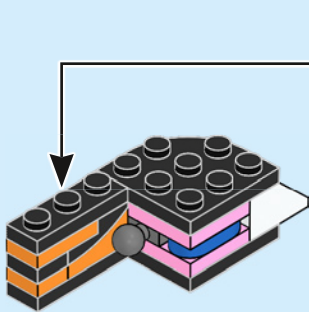
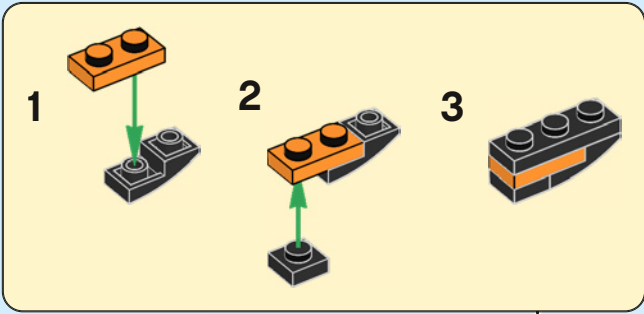

37

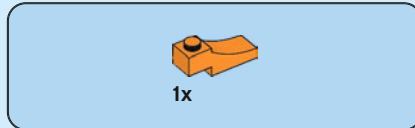
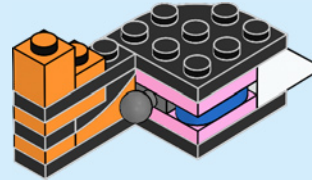

38

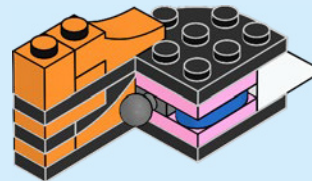

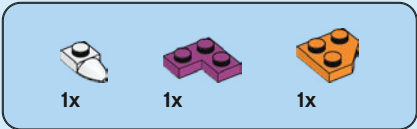

39

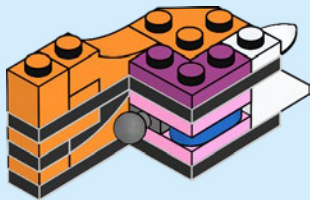

40

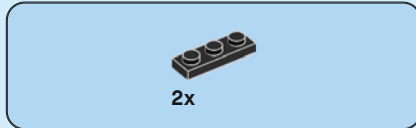
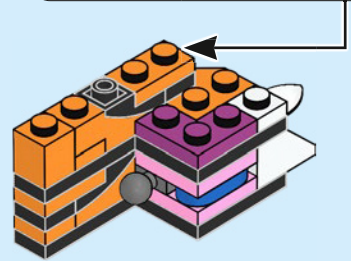
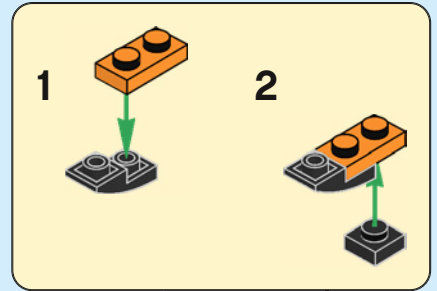

41

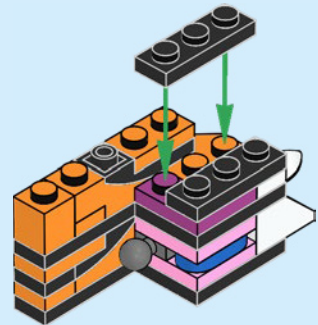

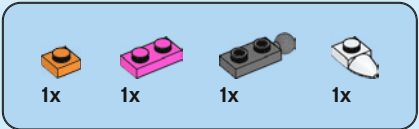

42

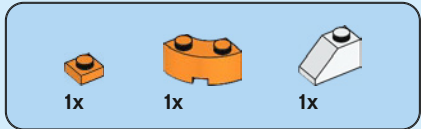
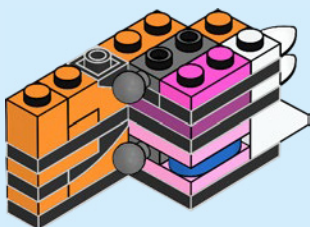

44

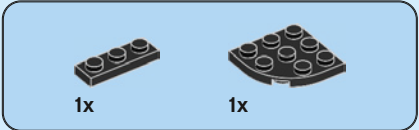
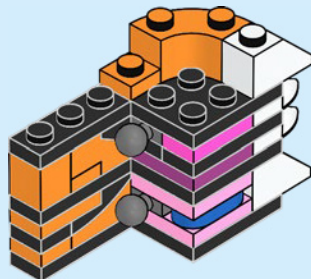

43

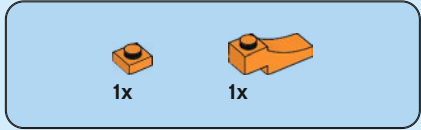
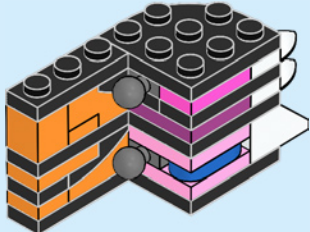

45

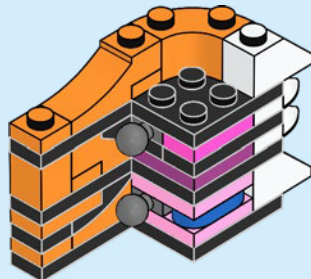



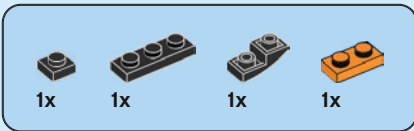

46

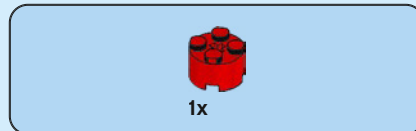
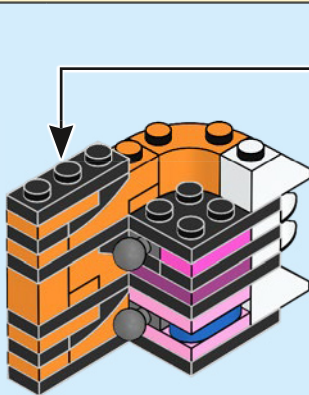
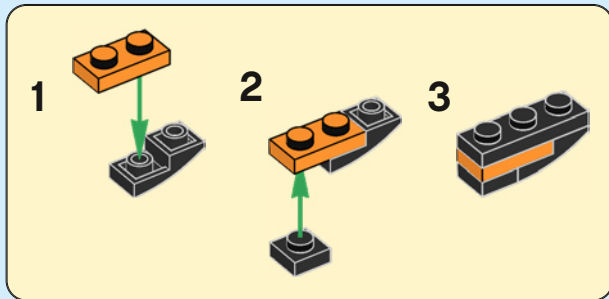

47

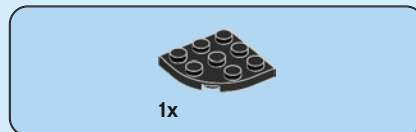
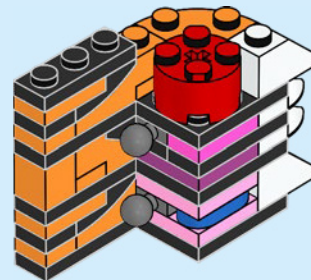

48

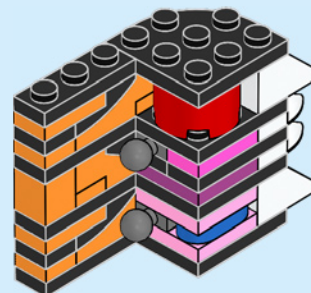

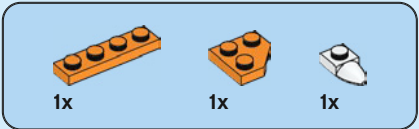

49

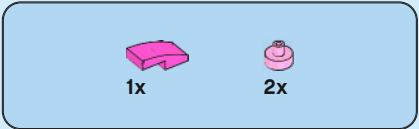
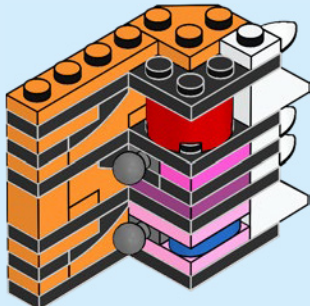

50

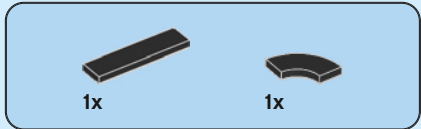
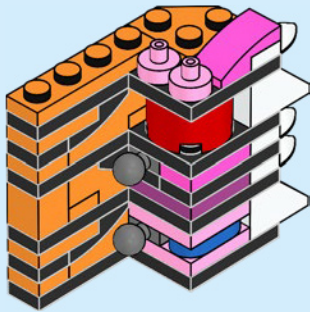

51

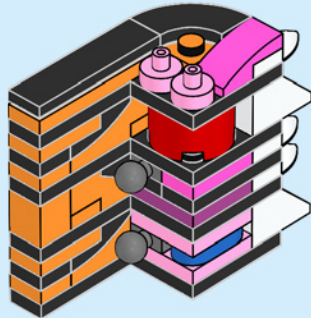

# 52

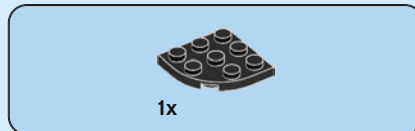
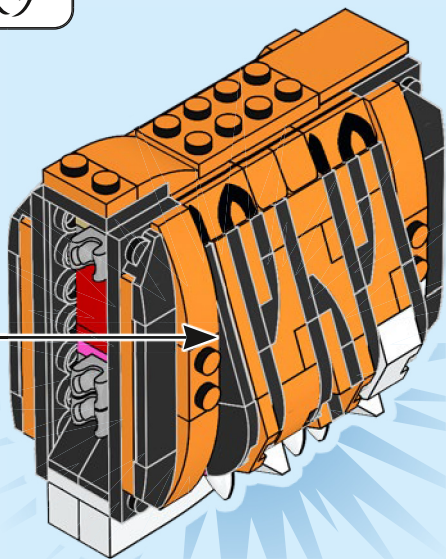

# 53

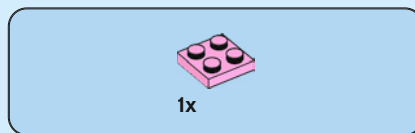
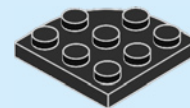

# 54

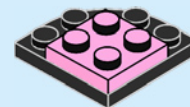

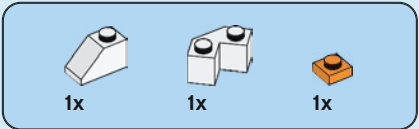

55

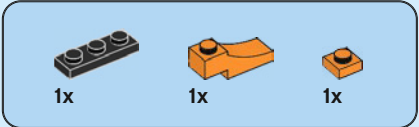
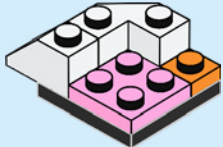

56

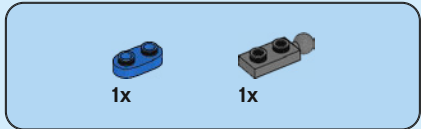
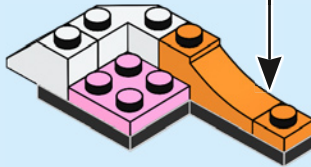
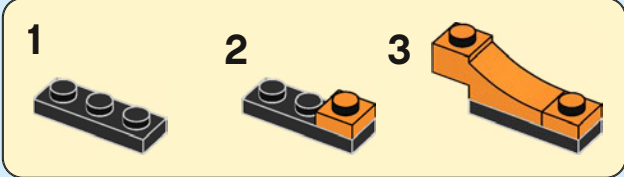

57

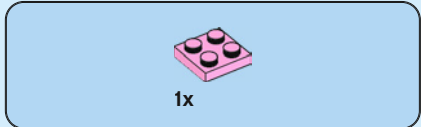
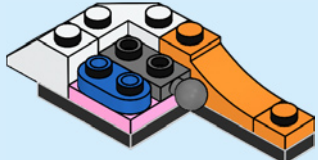

58

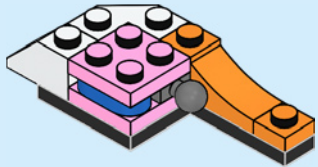

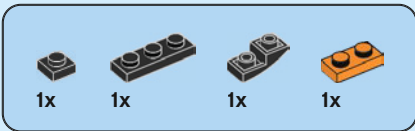

59

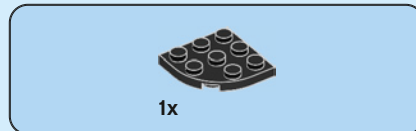
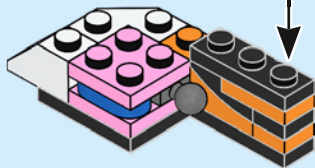
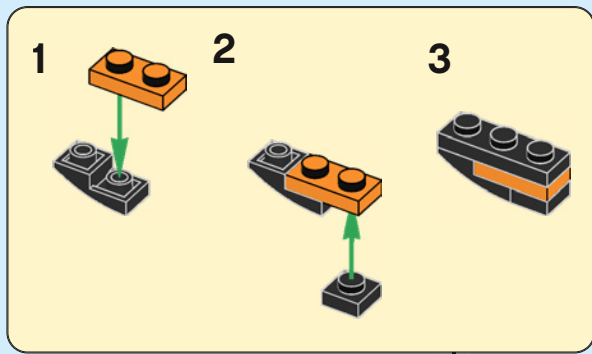

60

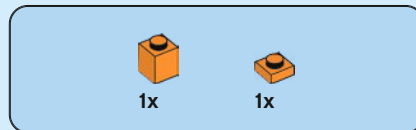
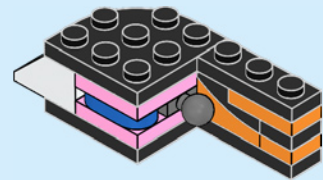

61

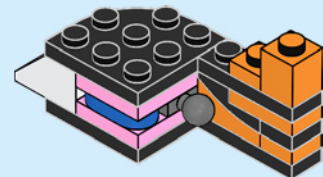



1x

# 62

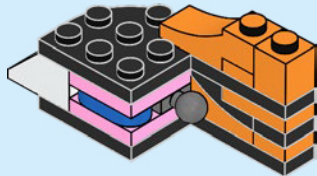

1x



1x



1x

# 63

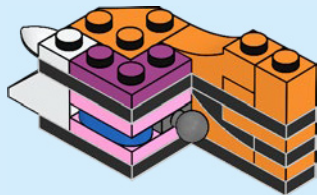

1x



1x



1x

# 64

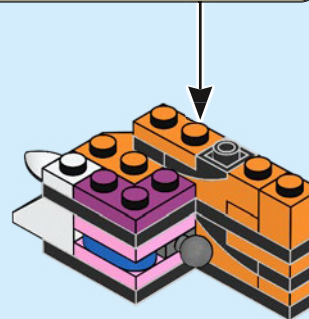
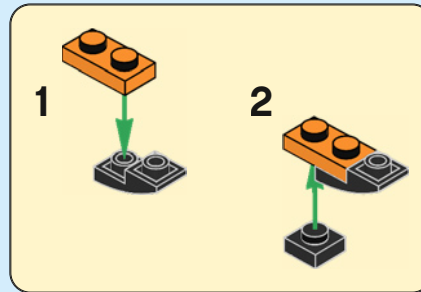





2x

# 65

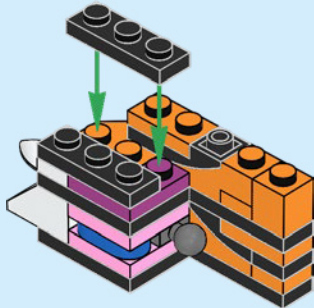

1x



1x



1x



1x

# 66

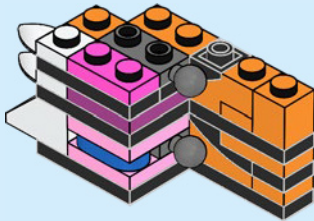

1x



1x

# 67

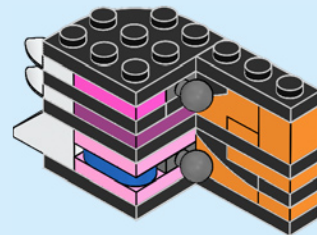

1x



1x



1x

# 68

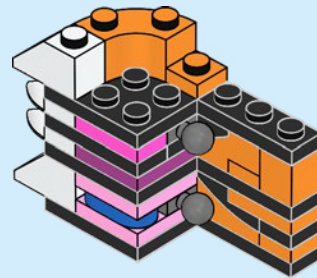

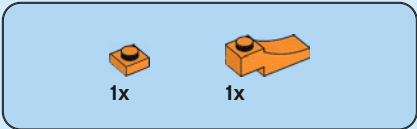

69

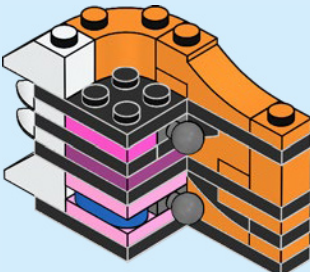

70

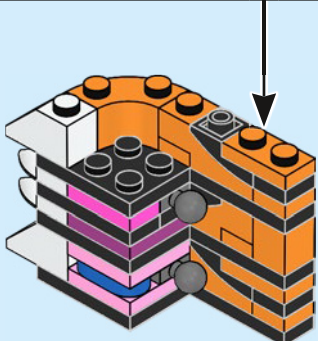
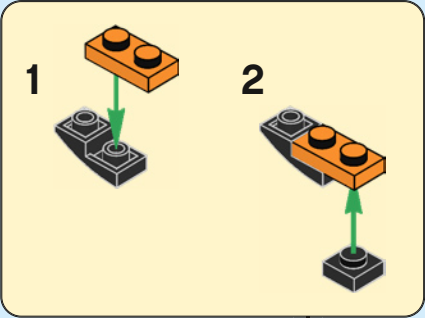



1x

71

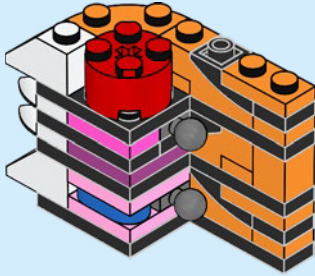

1x

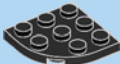

1x

72

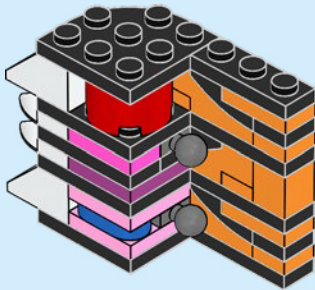

1x



1x



1x

73

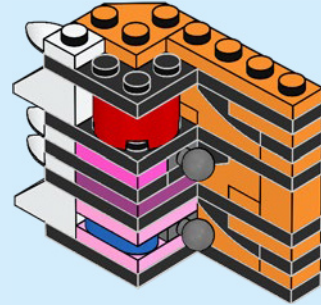

1x



2x

74

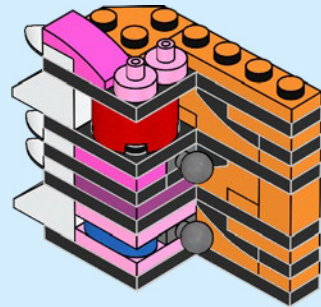

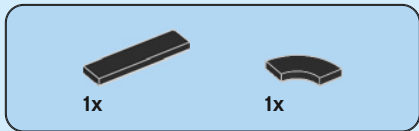

75

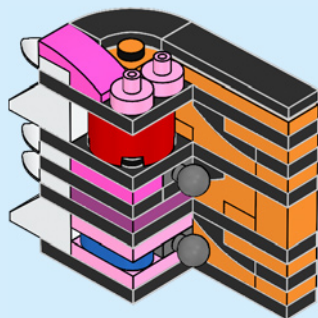

76

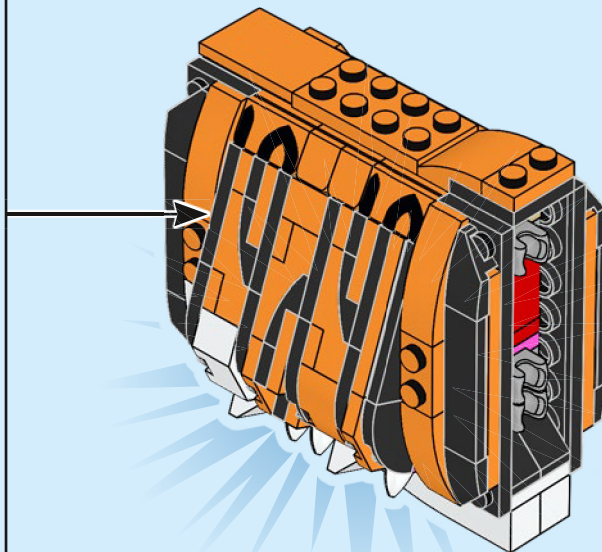

2

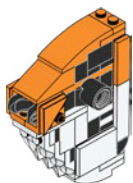
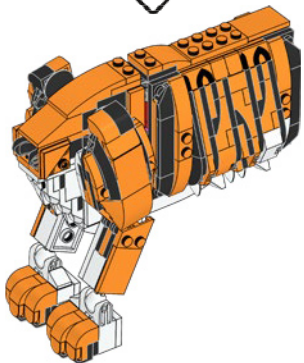
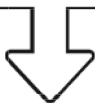

1x

77

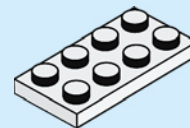

2x

78

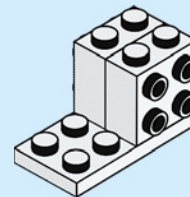



2x

# 79

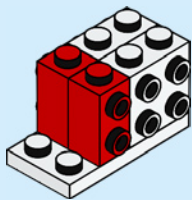

1x

# 80

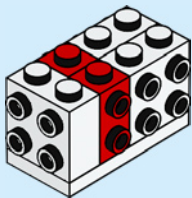

1x



2x

# 81

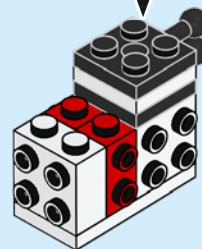
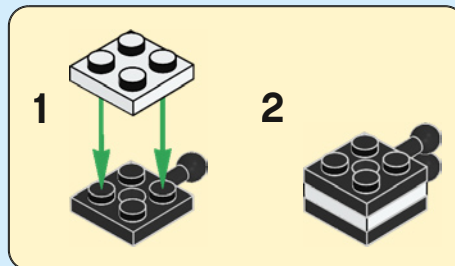





1x

# 82

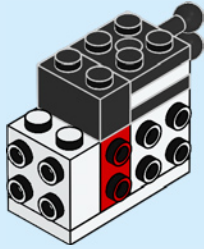

1x

# 83

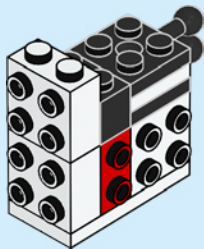

1x



2x

# 84

1



2

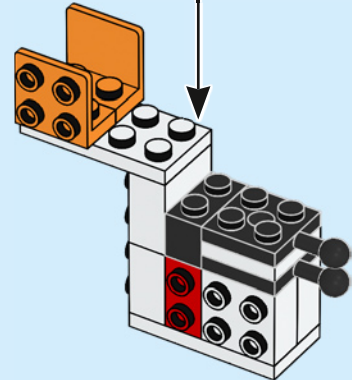
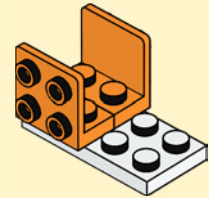

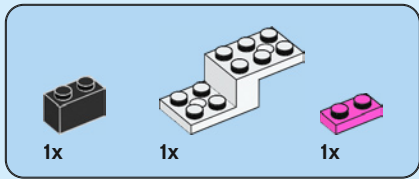

85

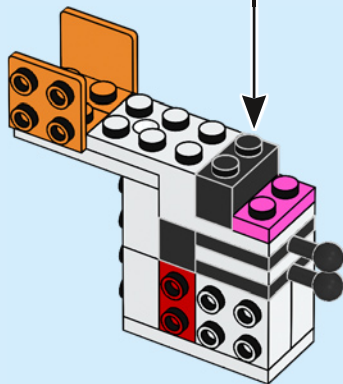
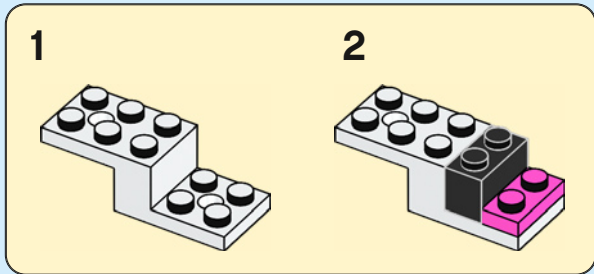

86

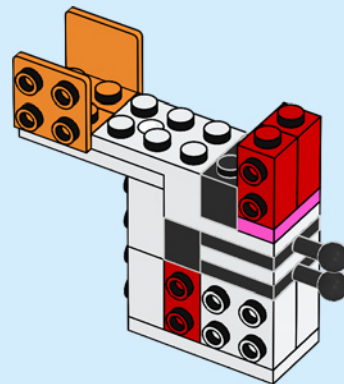

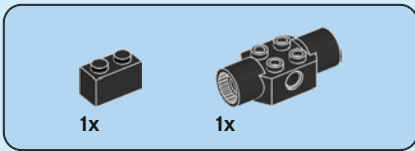

87

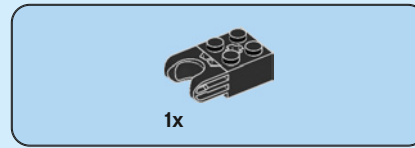
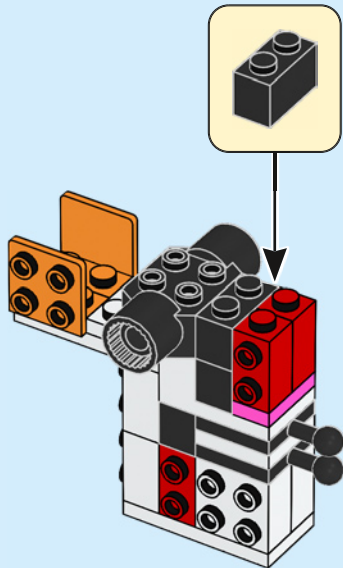

88

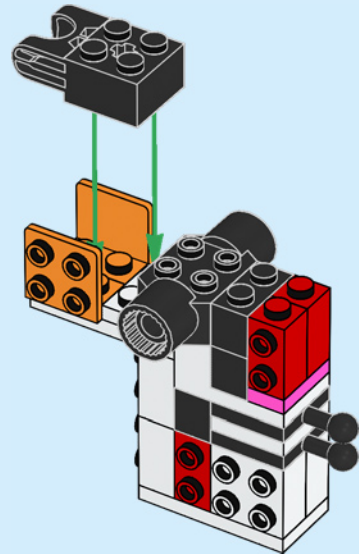

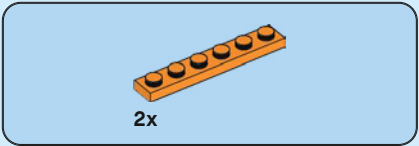

89

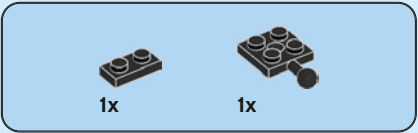
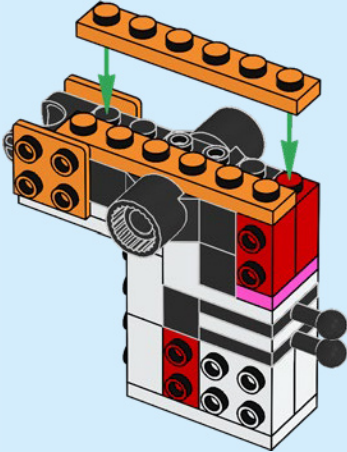

90

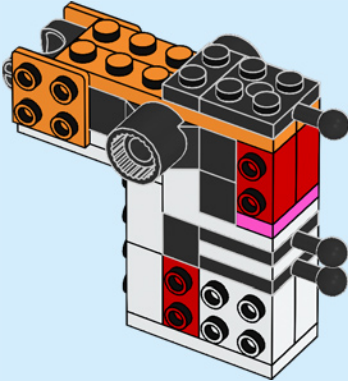



2x

91

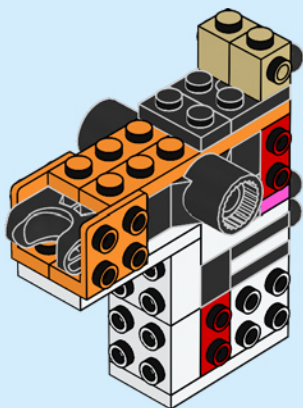

3x

92

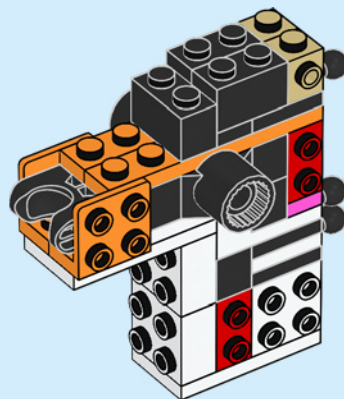

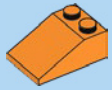

1x

93

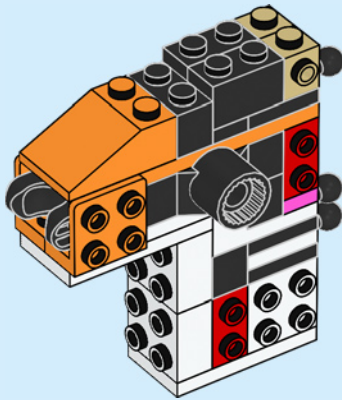

1x

94

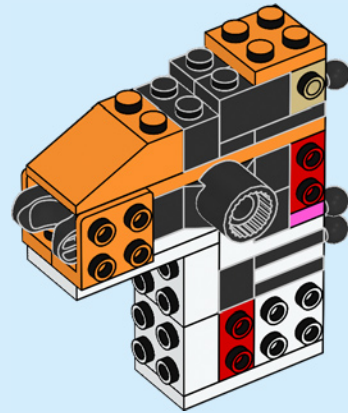



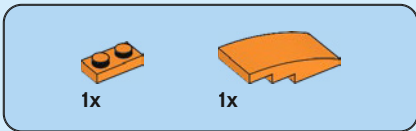

95

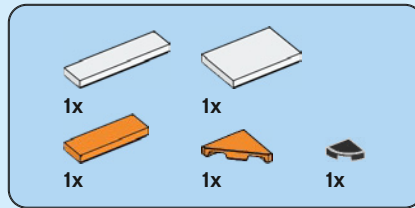
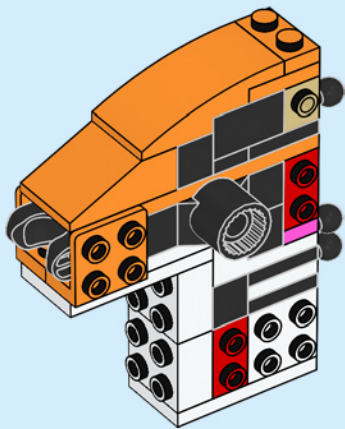

96

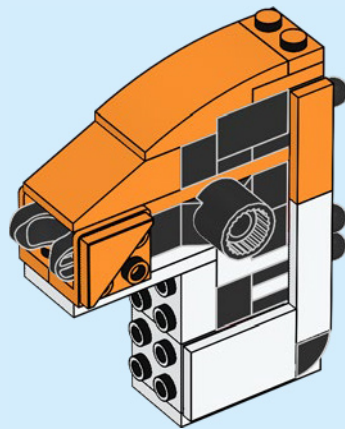

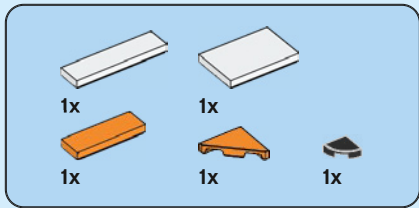

97

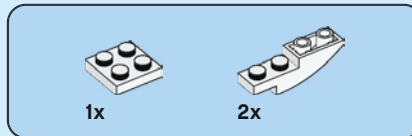
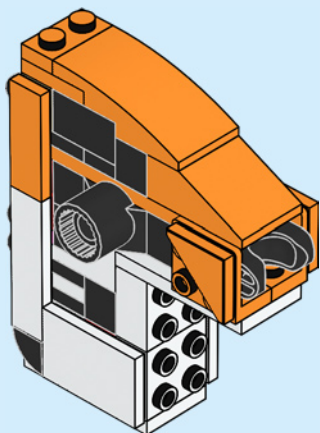

98

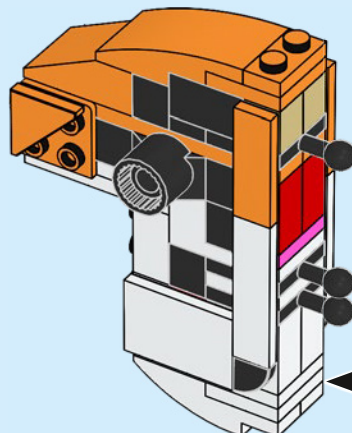
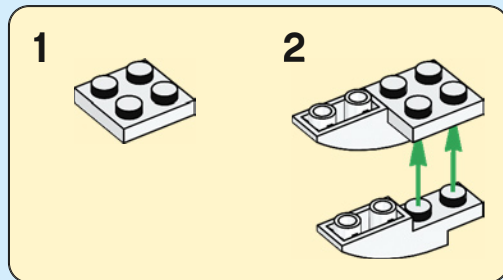

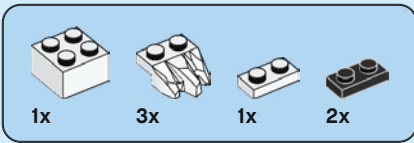

99

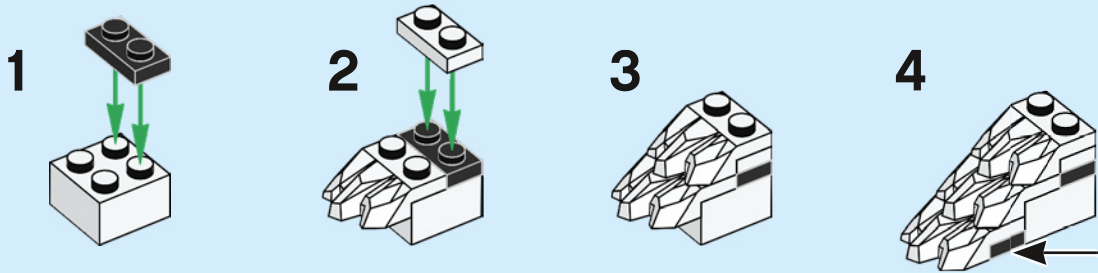

100

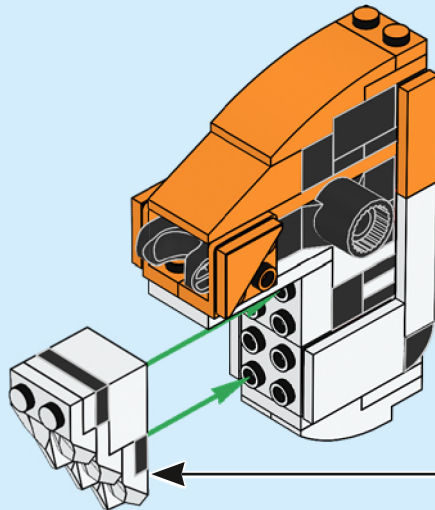

101

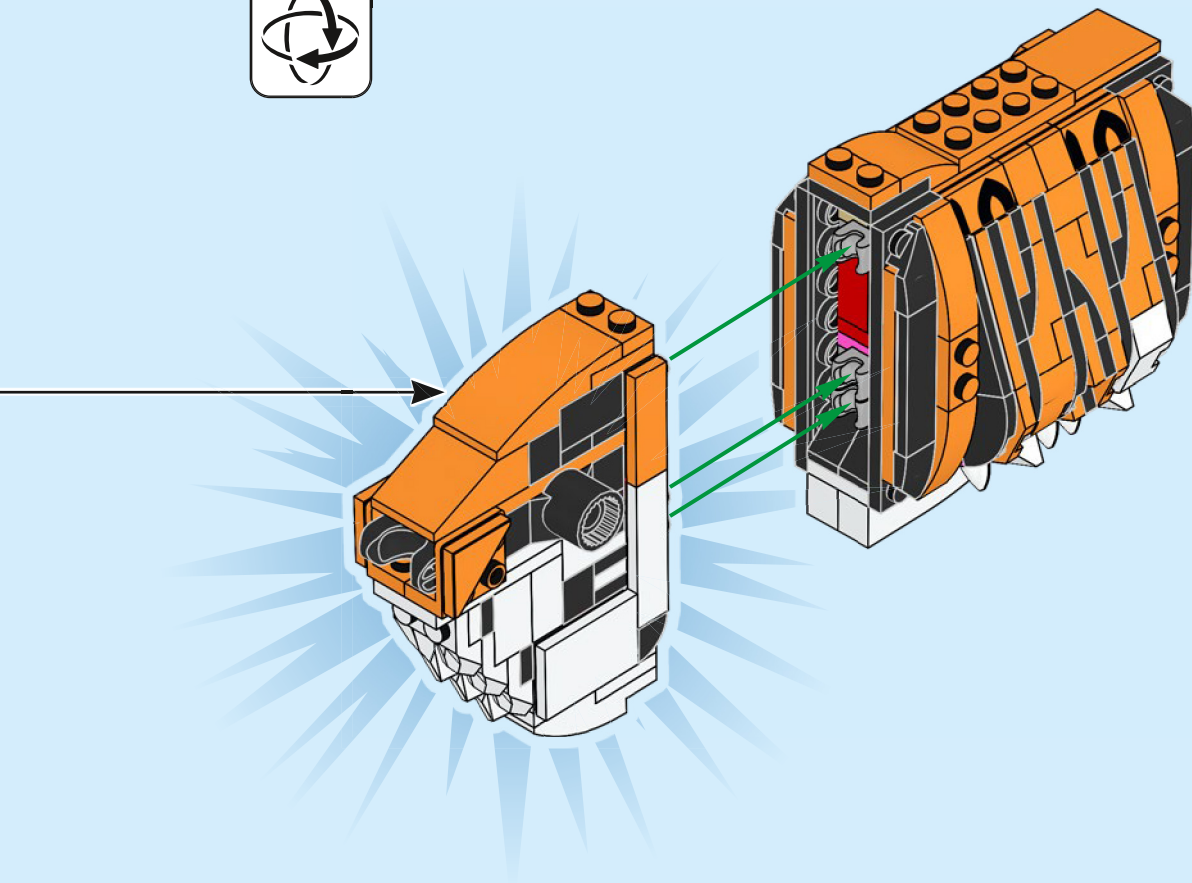

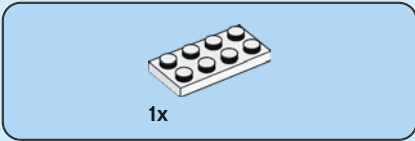
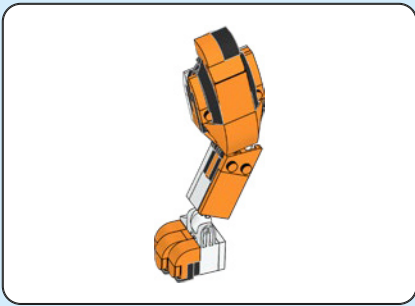

1x

102

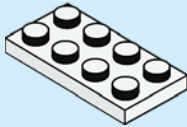

2x

103

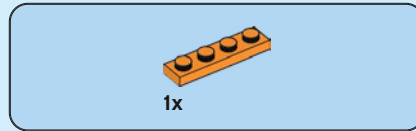
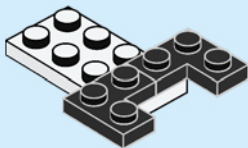

1x

104

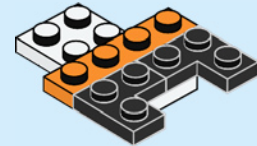

2x

105

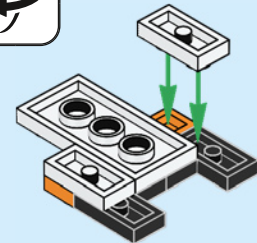

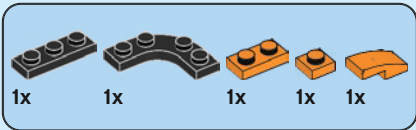

# 106

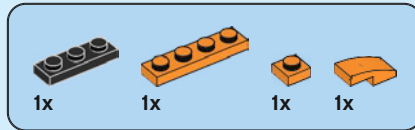
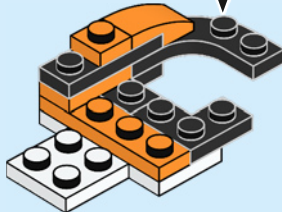
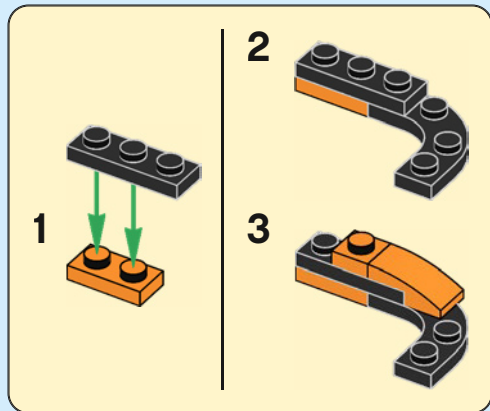

# 107

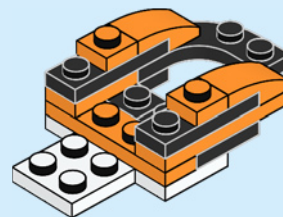
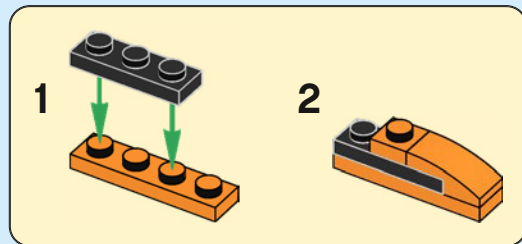





1x

# 108

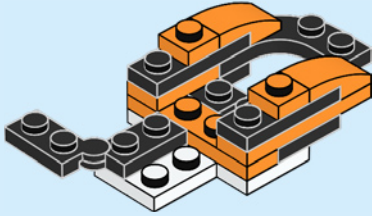

1x

# 109

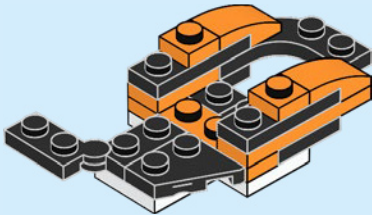

1x

# 110

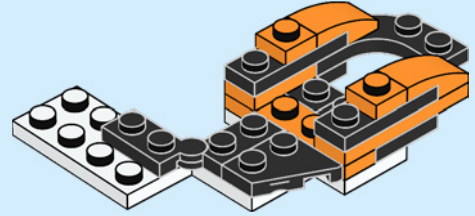

1x



1x



1x

# 111

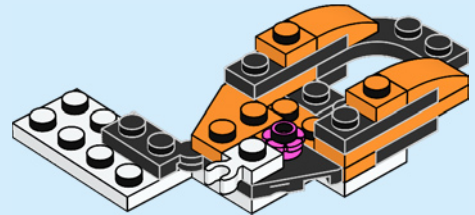



1x



1x

# 112

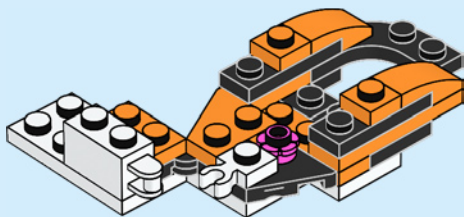

1x



1x



1x

# 113

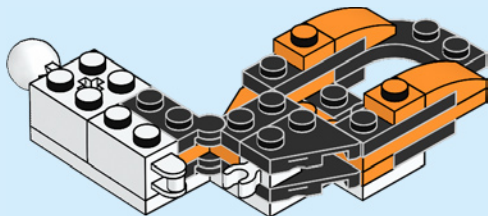

1x



1x

# 114

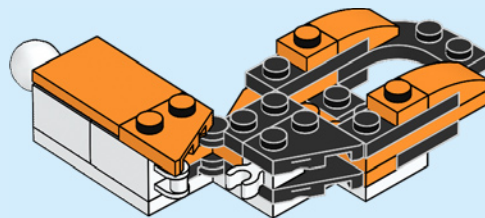

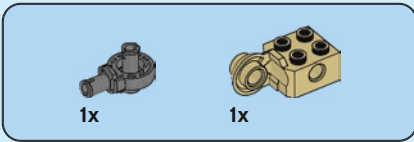

115

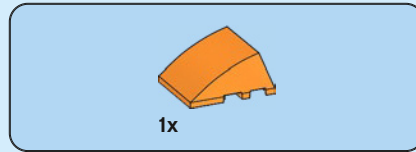
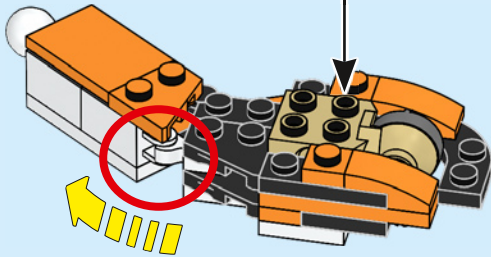

116

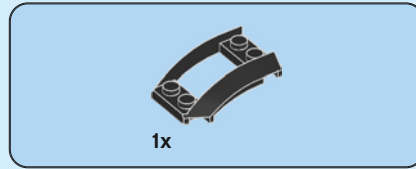
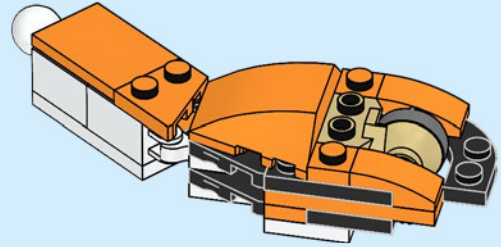

117

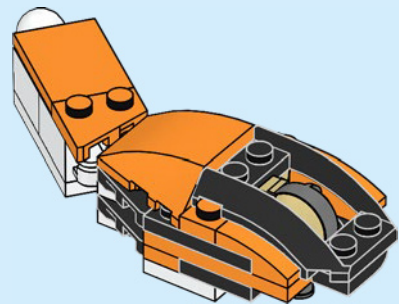



1x



1x

# 118

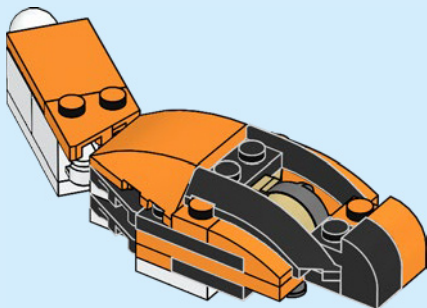

1x



1x

# 119

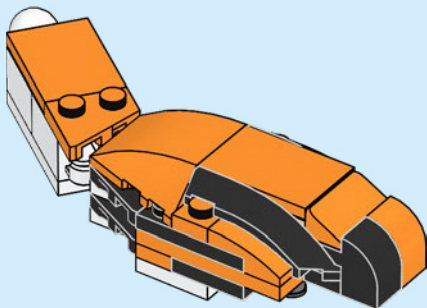

1x



2x

# 120

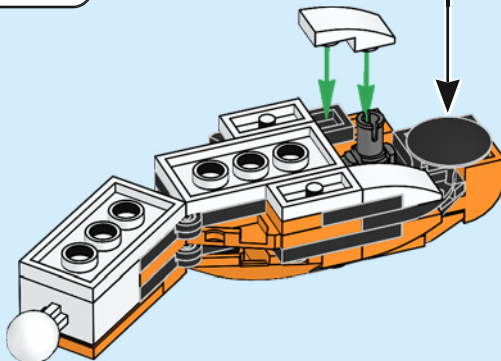



1x



1x

# 121

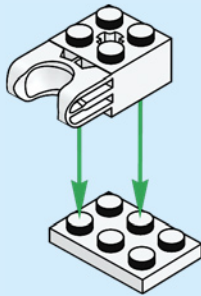

1x

# 122

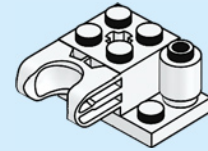

1x



1x

# 123

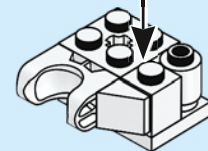
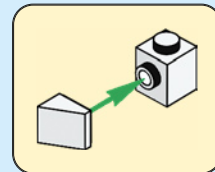

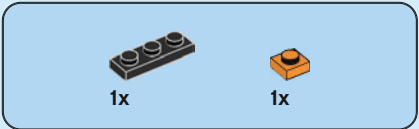

124

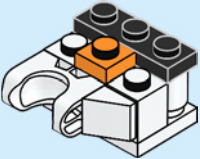

125

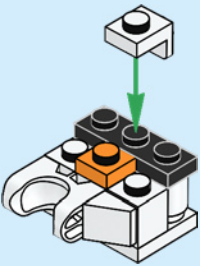

126

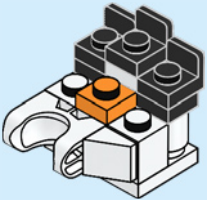

127

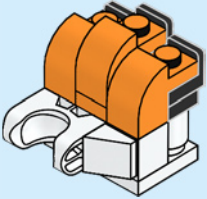



128

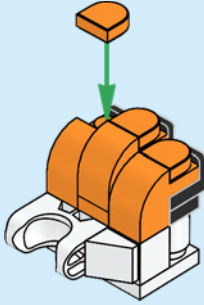

129

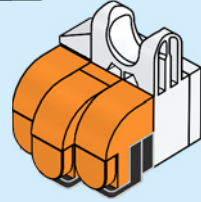

130

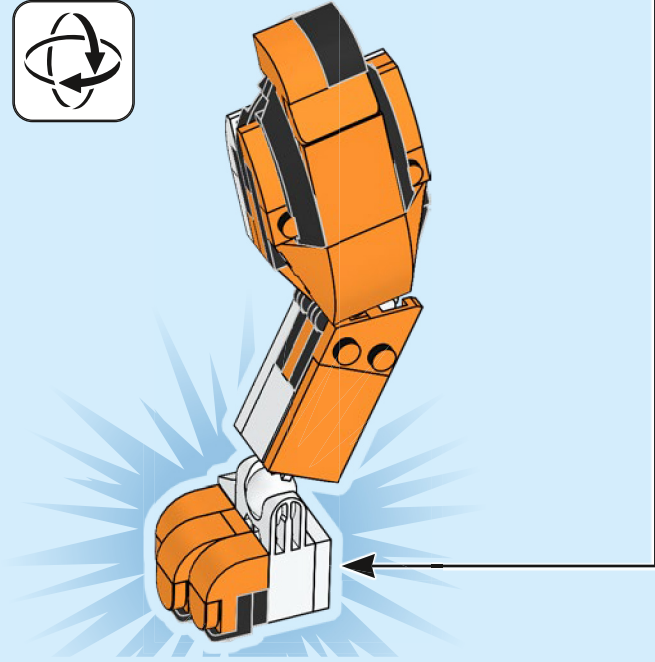



131

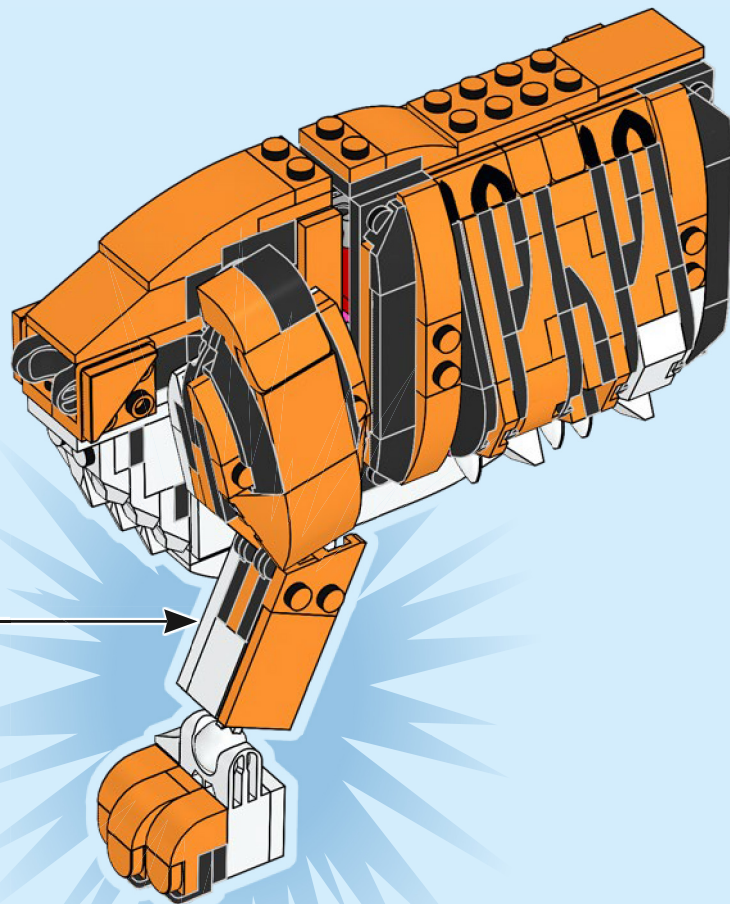

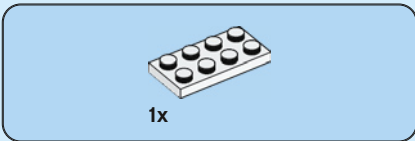
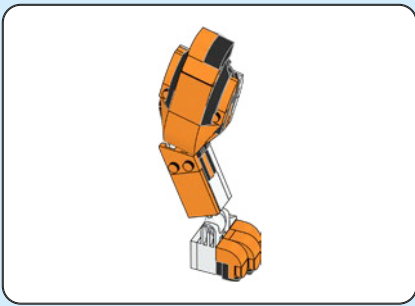

132

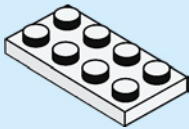

133

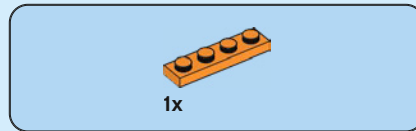
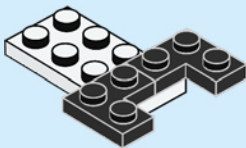

134

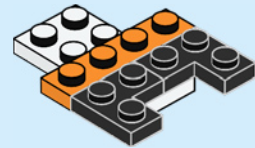

135

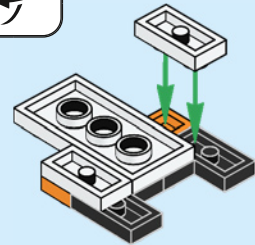
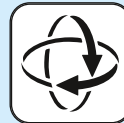

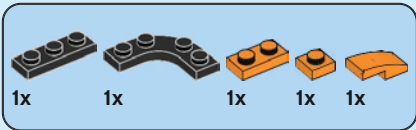

# 136

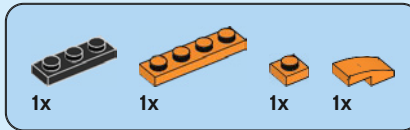
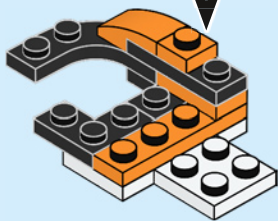
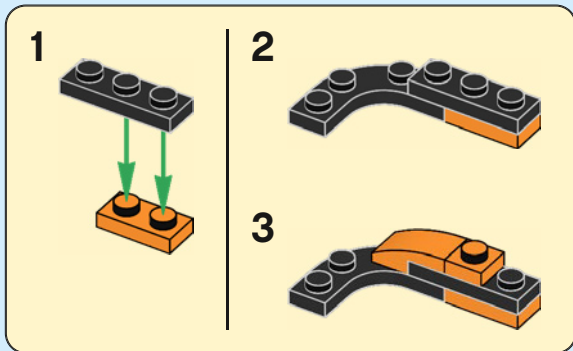

# 137

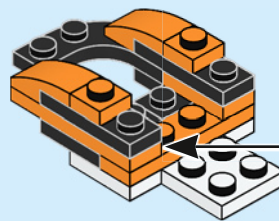
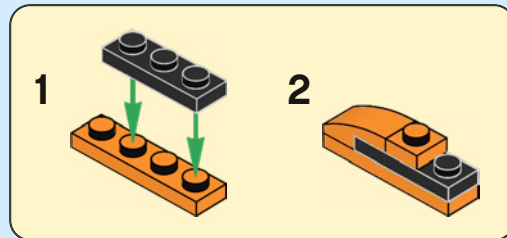



138

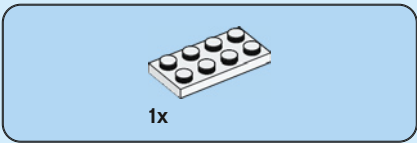
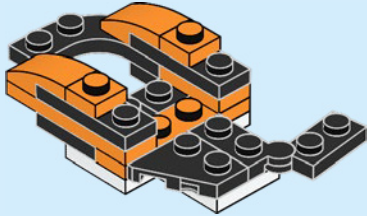

139

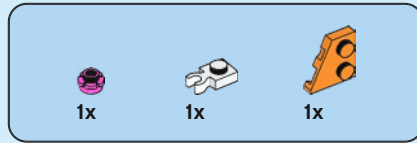
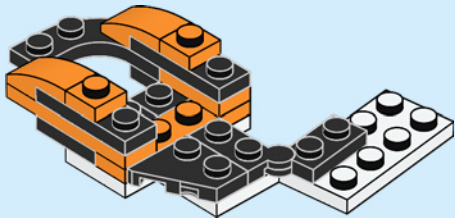

140

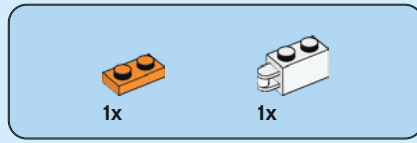
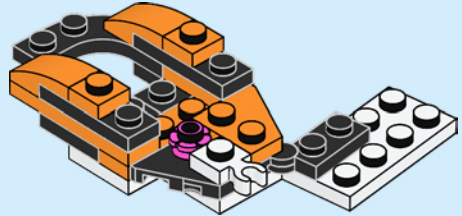

141

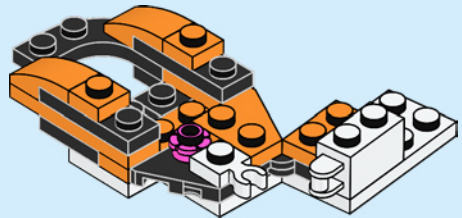



142

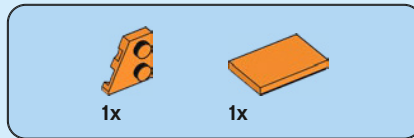
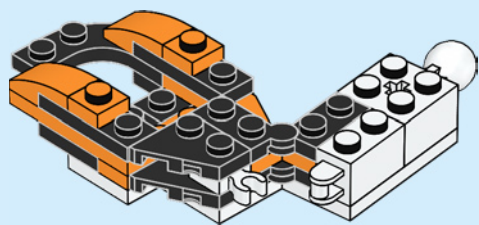

143

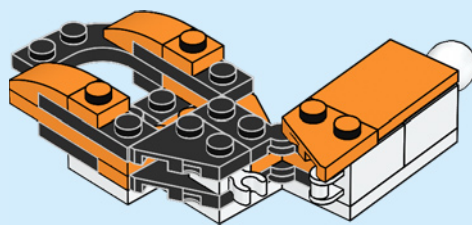

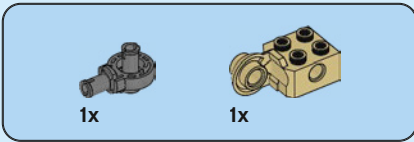

144

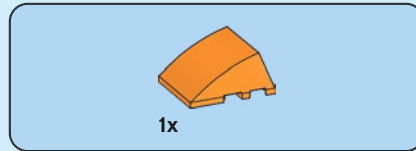
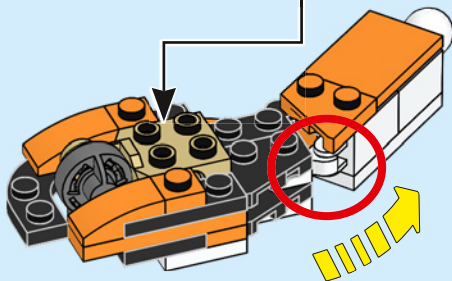

145

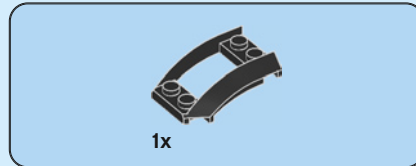
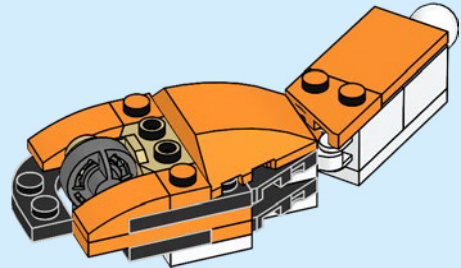

146

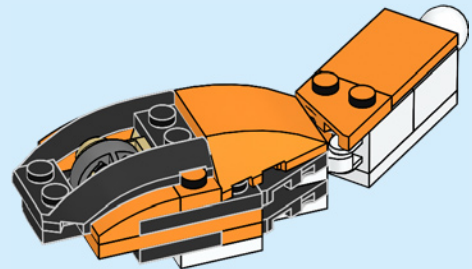



1x



1x

# 147

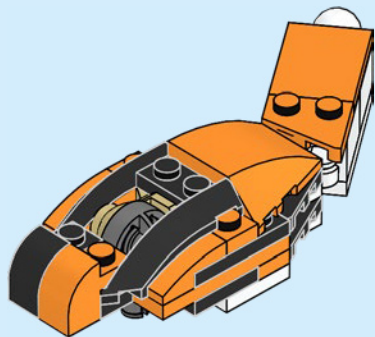

1x



1x

# 148

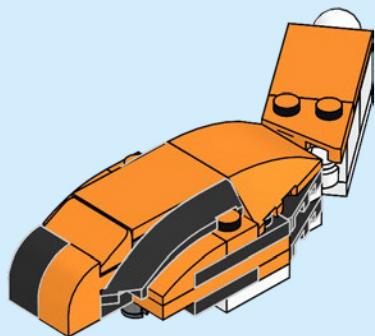

1x



2x

# 149

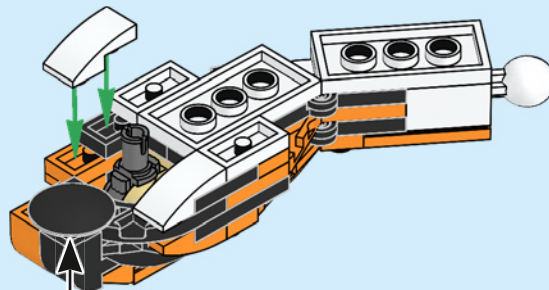



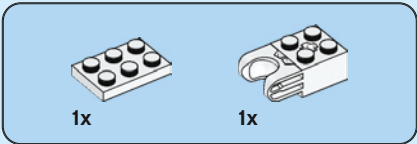

150

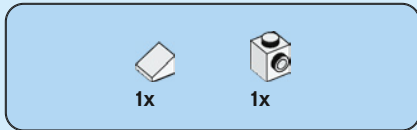
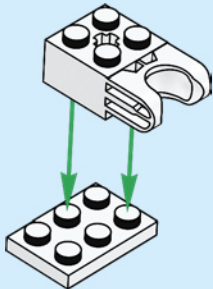

151

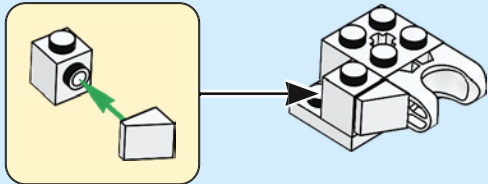

152

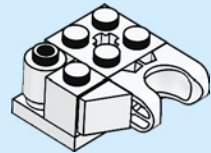



1x



1x

# 153

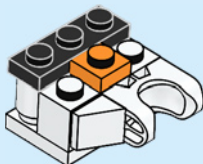

1x

# 154

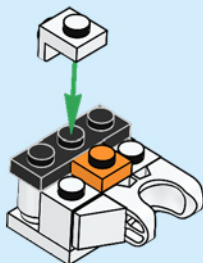

3x

# 155

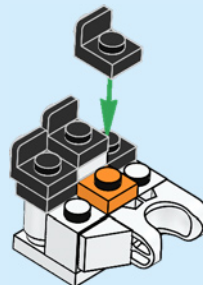

3x

# 156

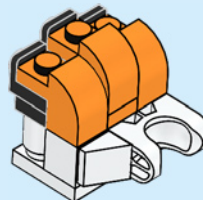

3x

157

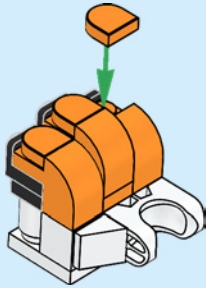

158

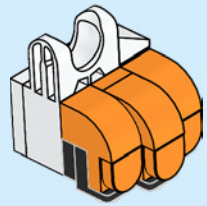

159

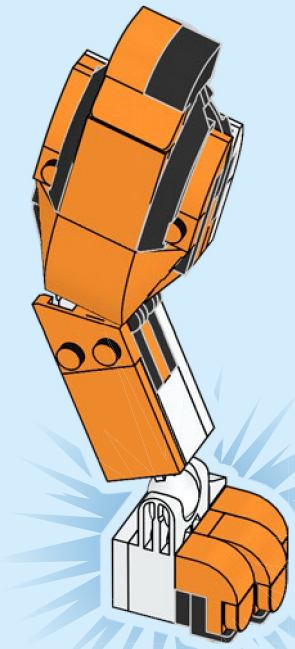

160

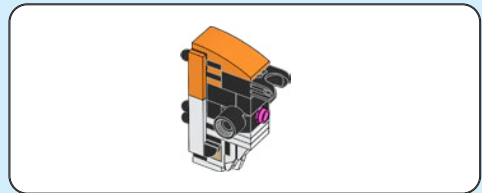
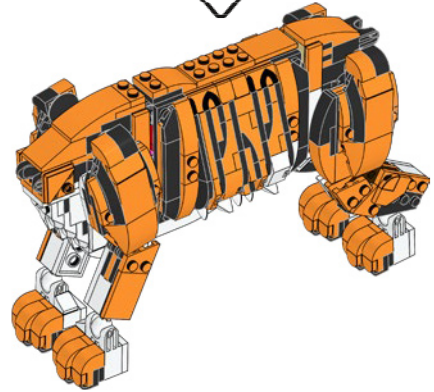
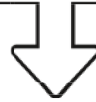
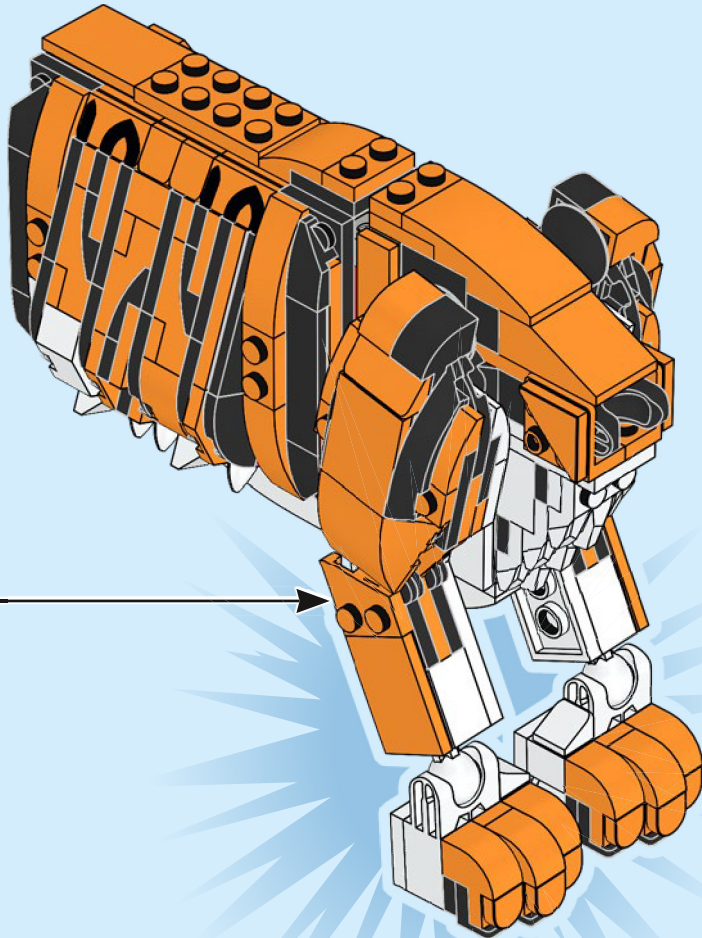

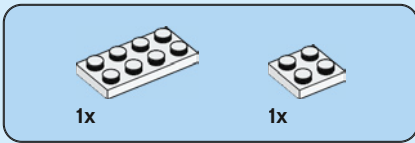

**161**

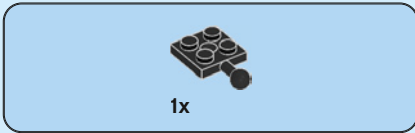
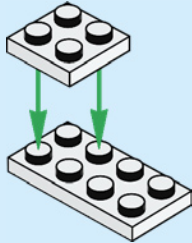

**162**

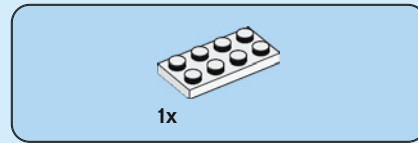
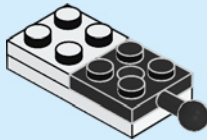

**163**

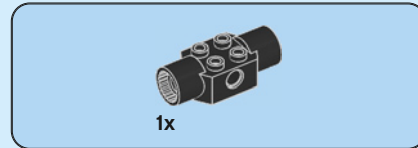
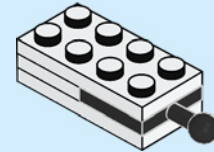

**164**

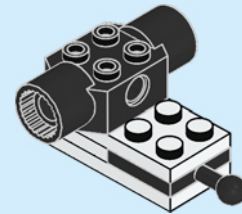



# 165

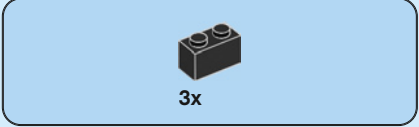
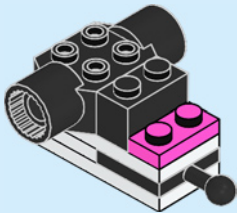

# 166

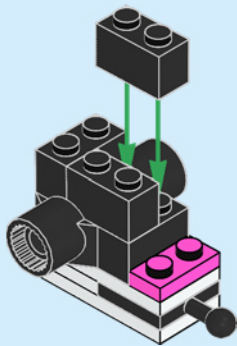

# 167

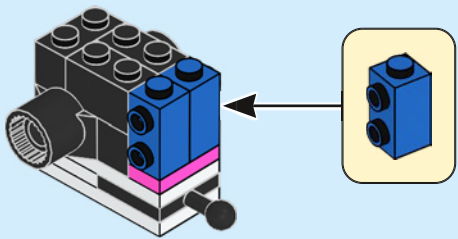

# 168

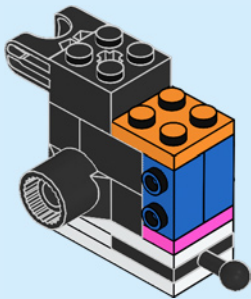



1x

169

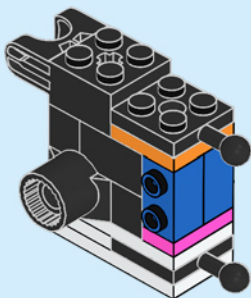

1x



1x

170

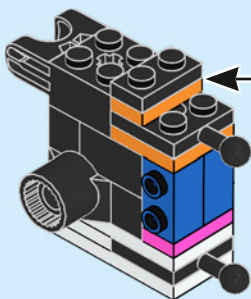

2x

171

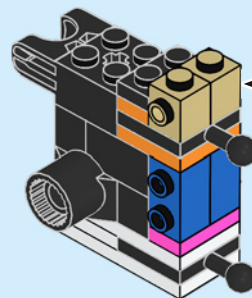

1x

172

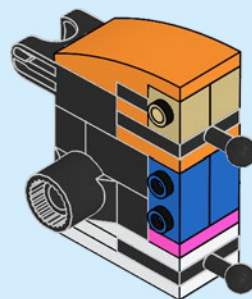





1x



1x

# 173

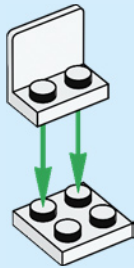

1x

# 174



2x

# 175

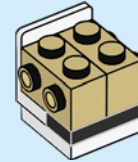

1x

# 176

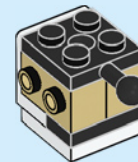

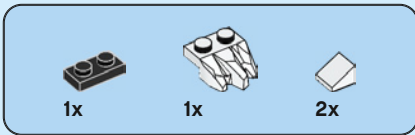

177

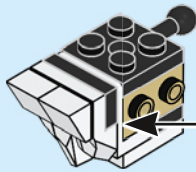
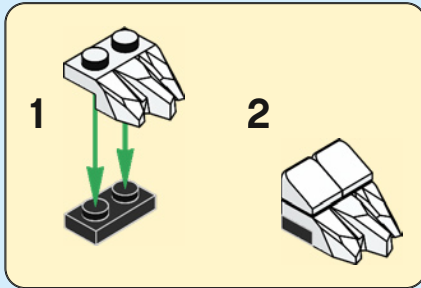

178

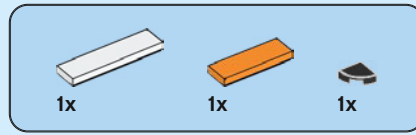
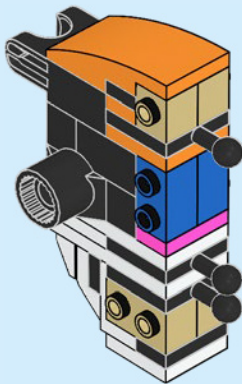

179

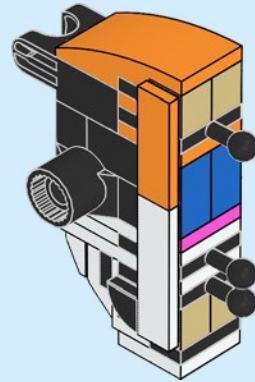

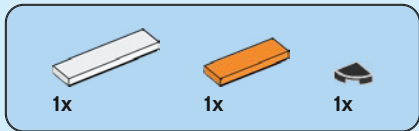

180

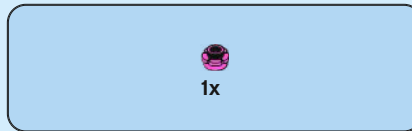
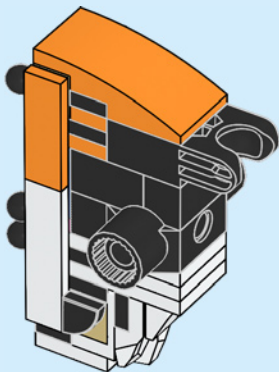

181

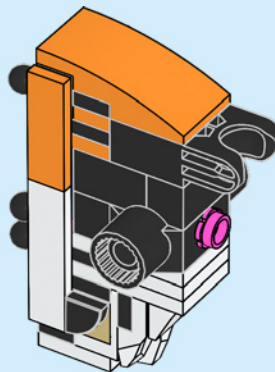

182

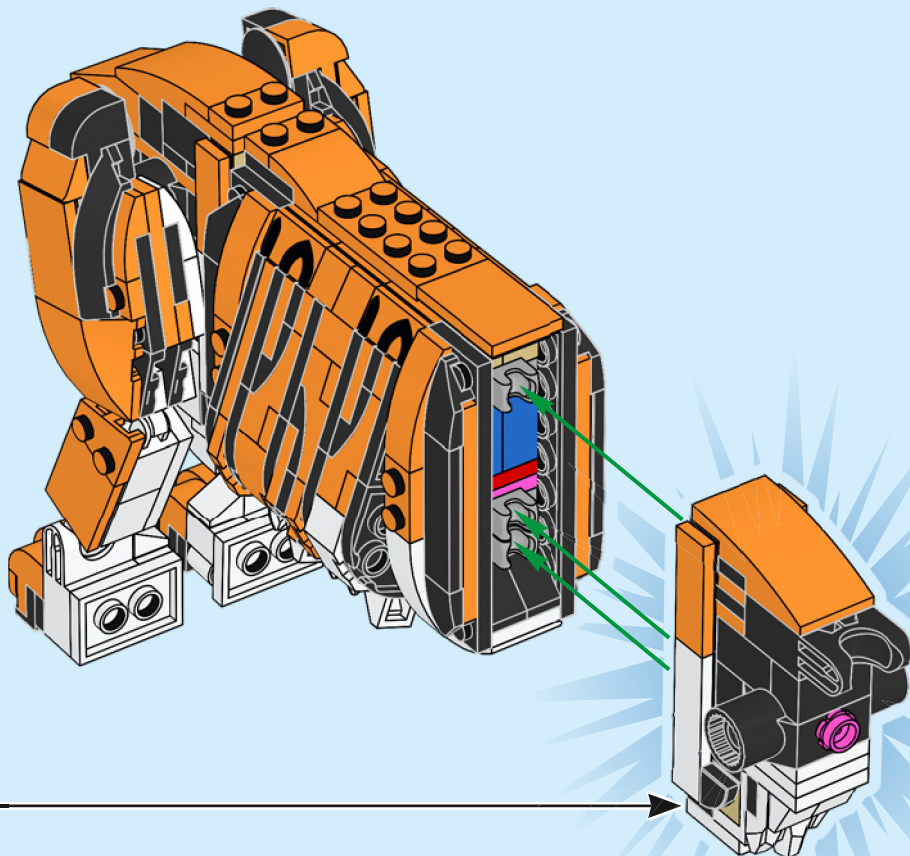

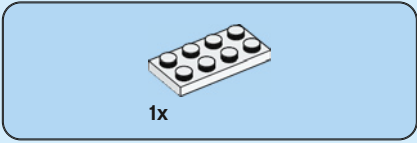
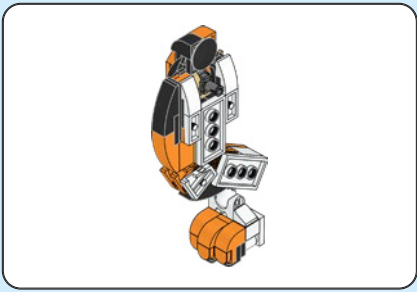

**183**

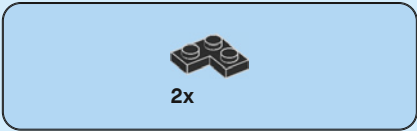
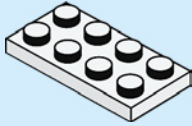

**184**

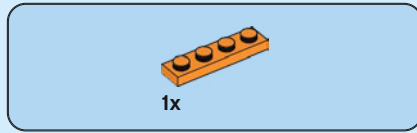
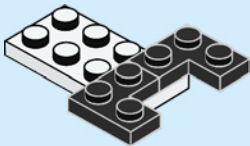

**185**

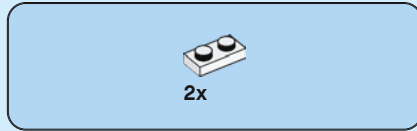
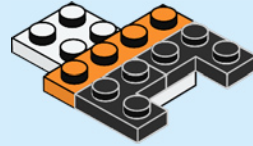

**186**

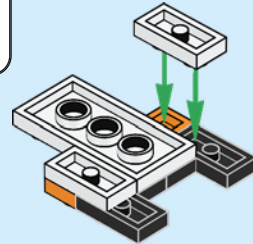

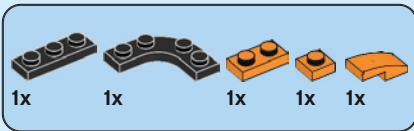

# 187

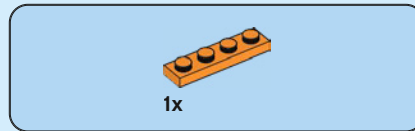
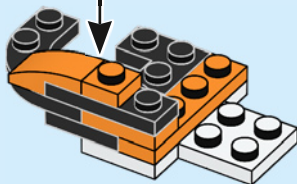
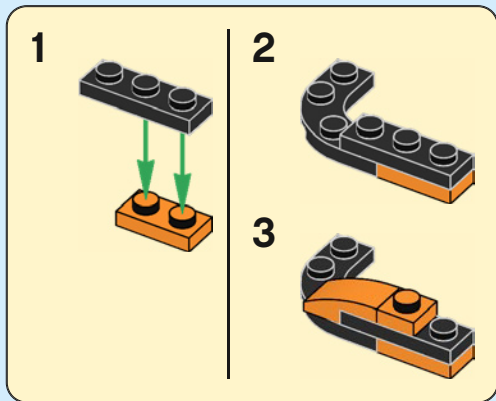

# 188

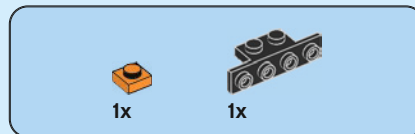
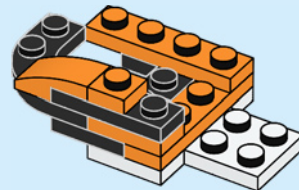

# 189

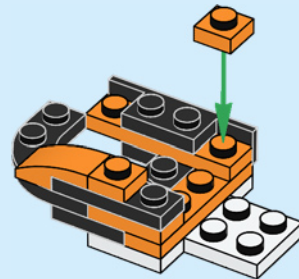



1x



1x

# 190

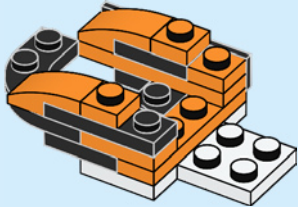

1x

# 191

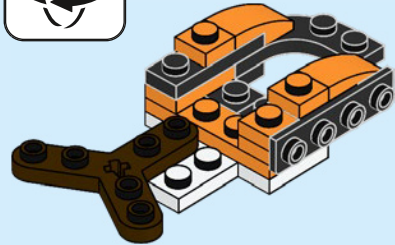

1x



1x

# 192

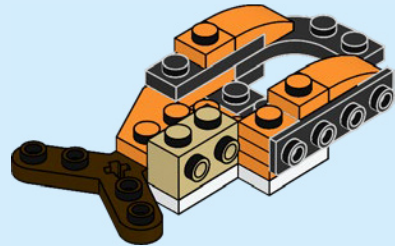



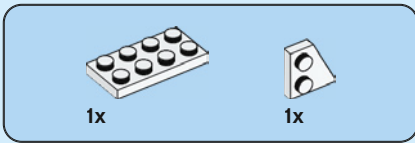

193

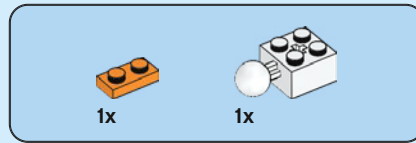
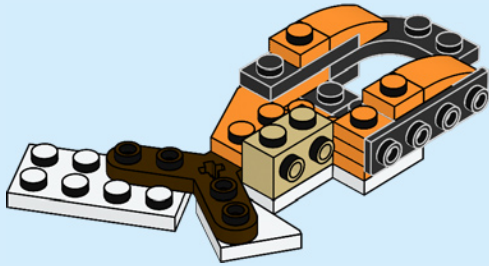

194

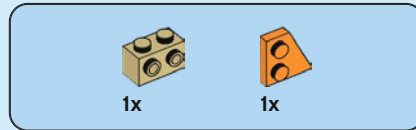
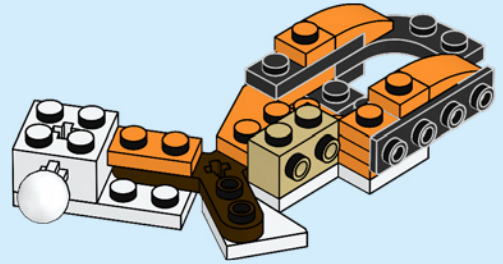

195

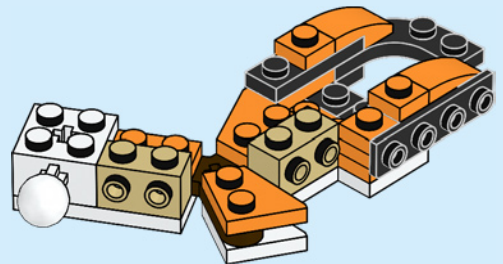



1x

# 196

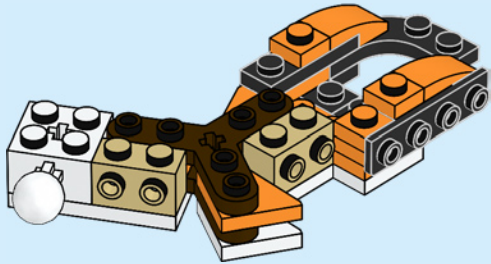

1x



1x

# 197

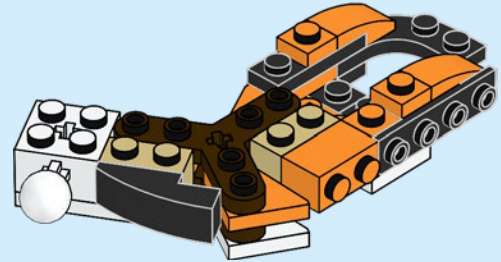

1x



2x

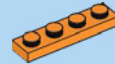

1x

# 198

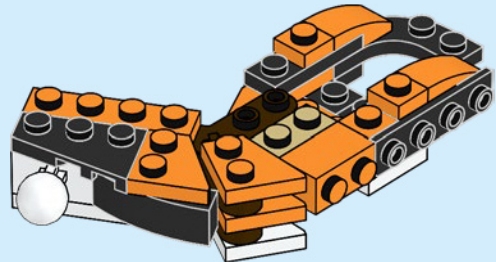

1x



1x

# 199

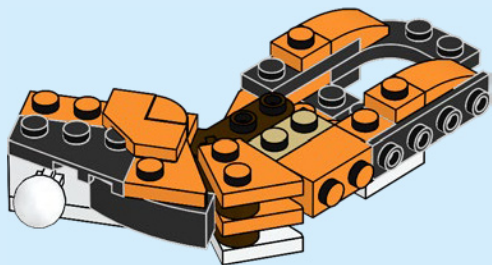

1x

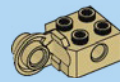

1x

# 200

**CLICK KLICK  
CLIC CLIQUE  
KATT KLIKSKIS  
咔嗒**

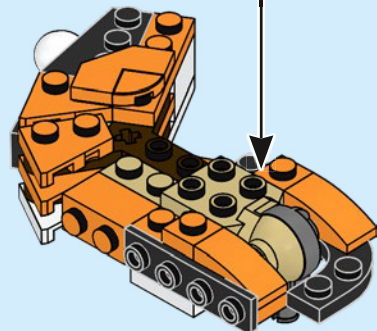
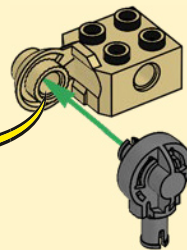



1x

# 201

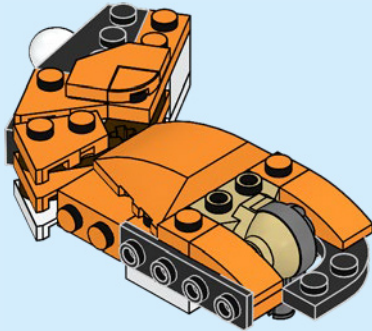

1x

# 202

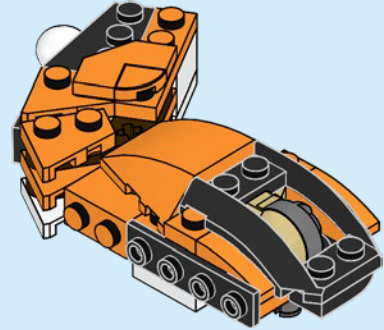

1x



1x

# 203

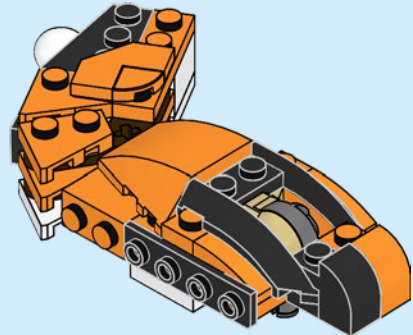

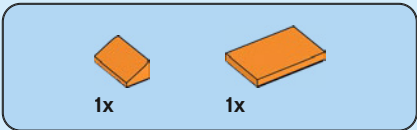

204

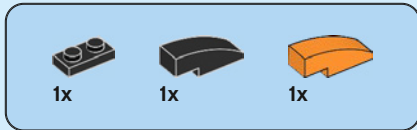
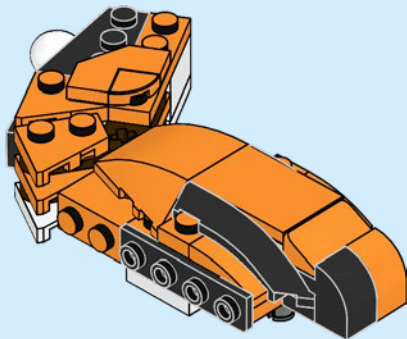

205

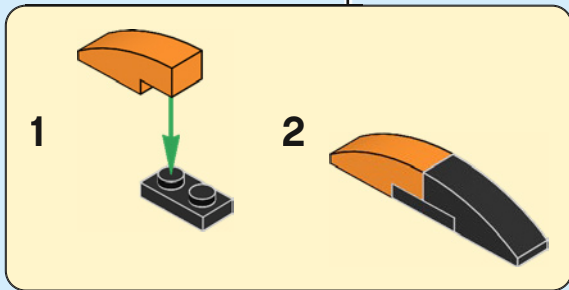
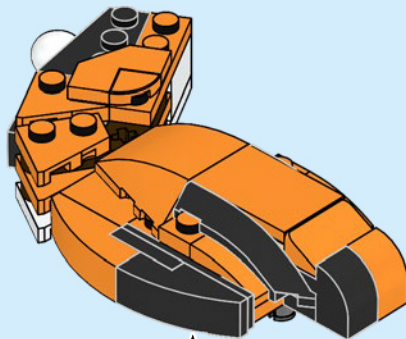



206

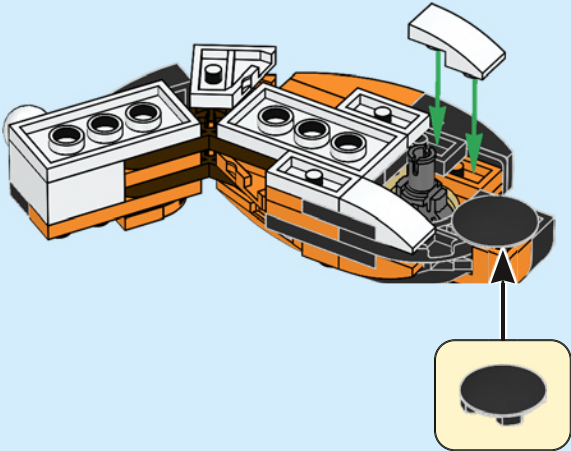



1x



1x

# 207

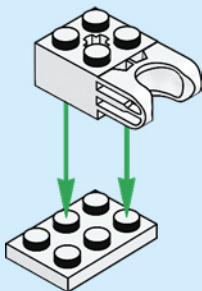

1x



1x

# 208

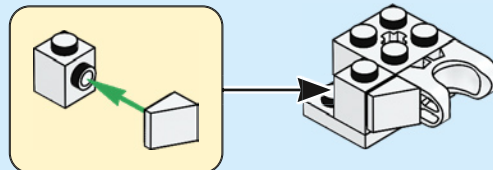

1x

# 209

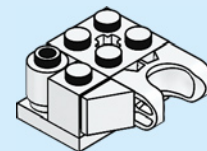



210

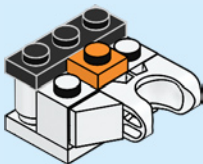

211

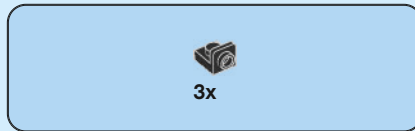
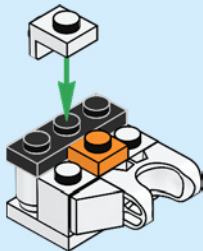

212

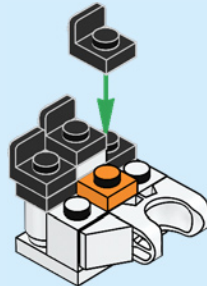

213

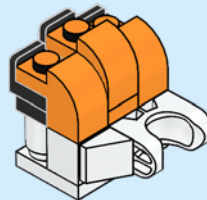



3x

214

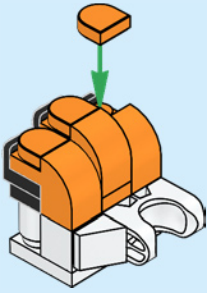

215

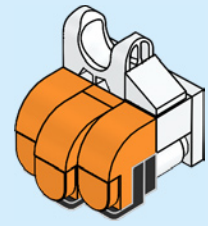

216

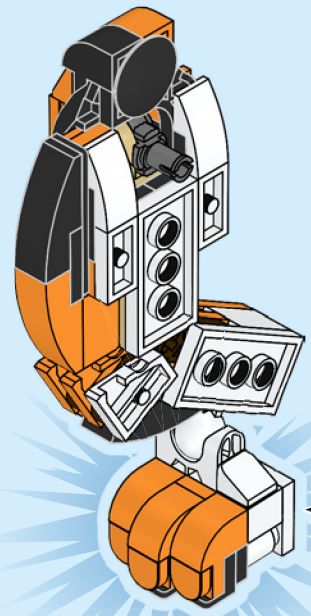
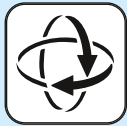

217

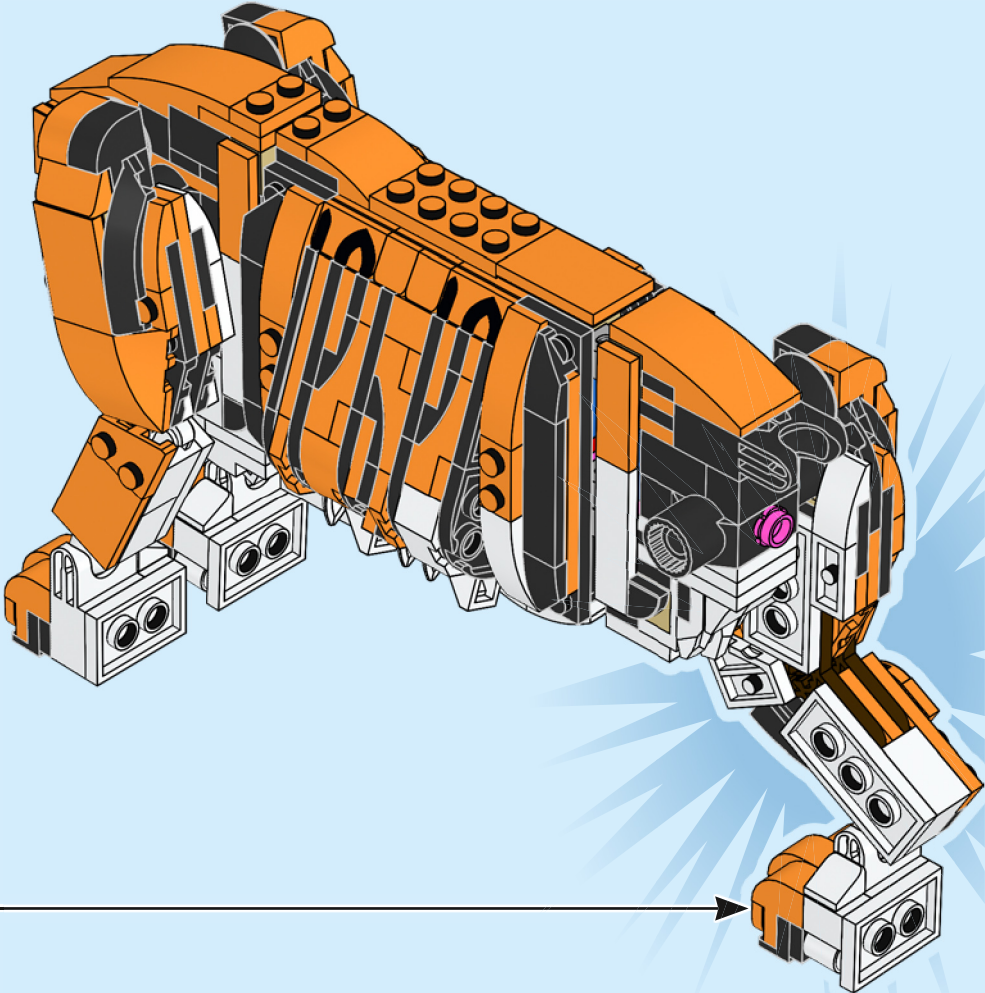

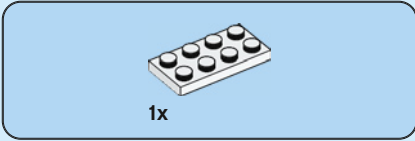
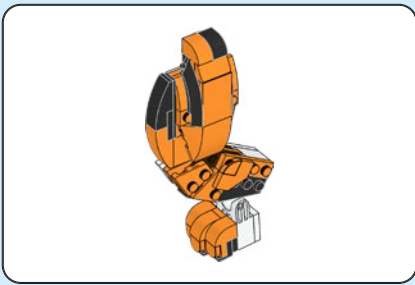

218



219

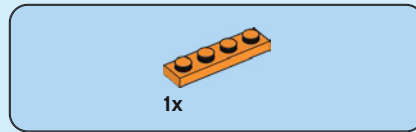
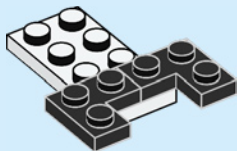

220

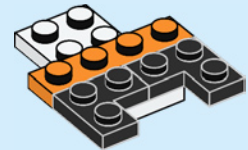

221

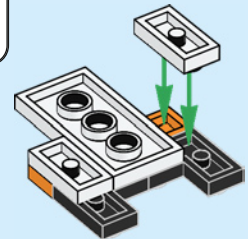

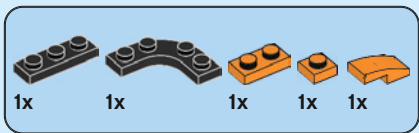

222

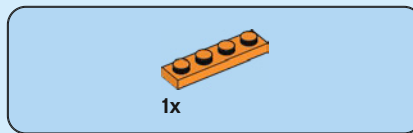
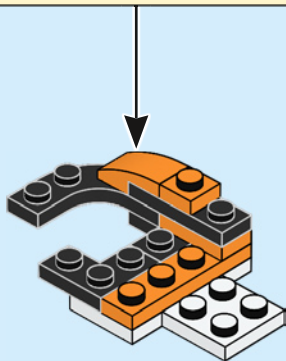
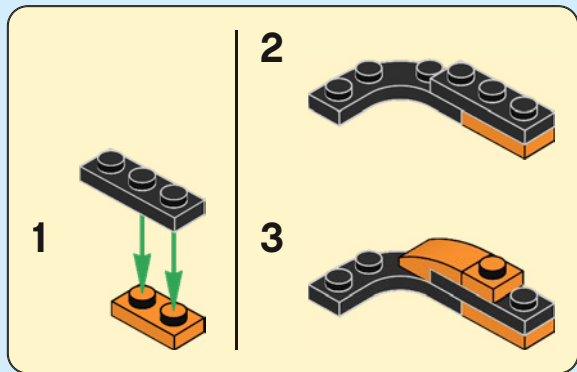

223

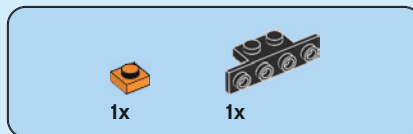
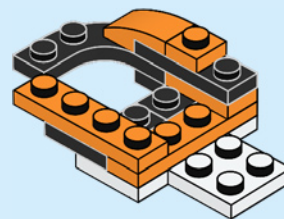

224

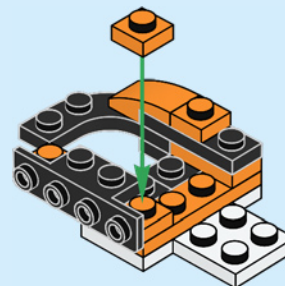



1x



1x

# 225

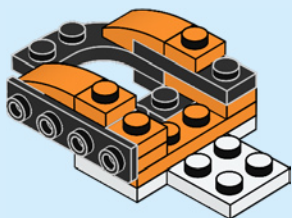

1x

# 226

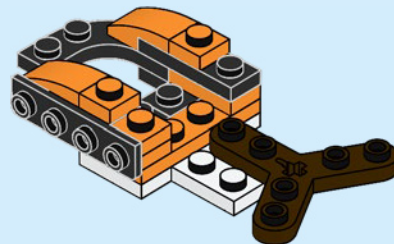

1x



1x

# 227

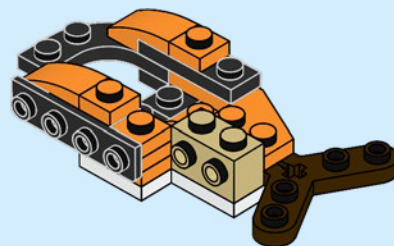

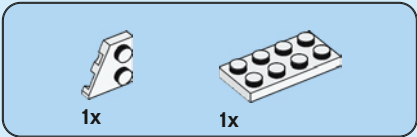

228

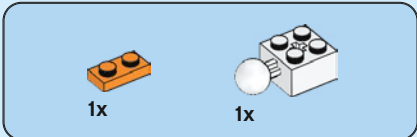
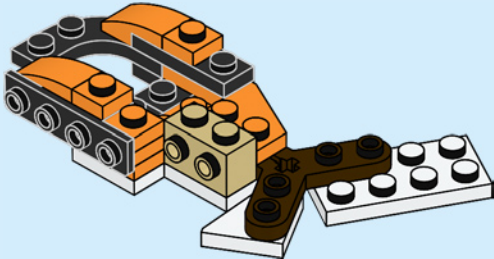

229

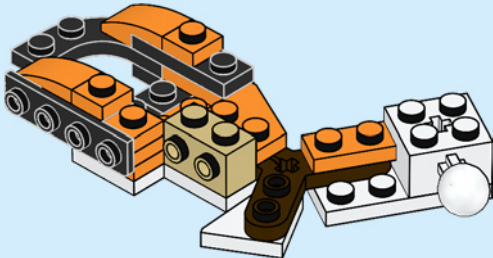

230

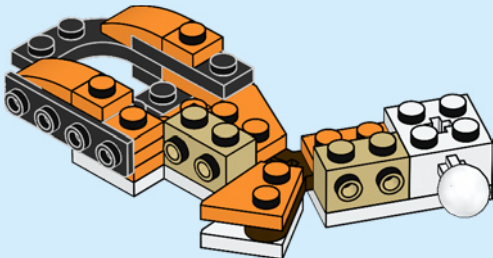



1x

# 231

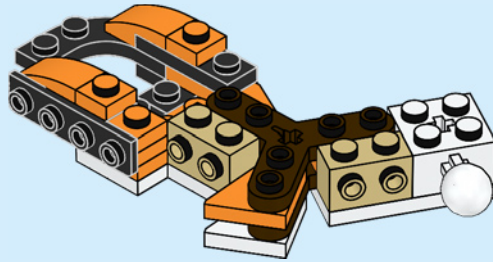

1x



1x

# 232

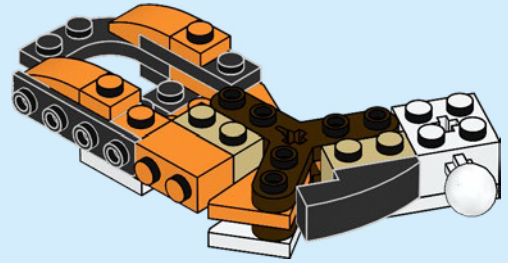

1x



2x



1x

# 233

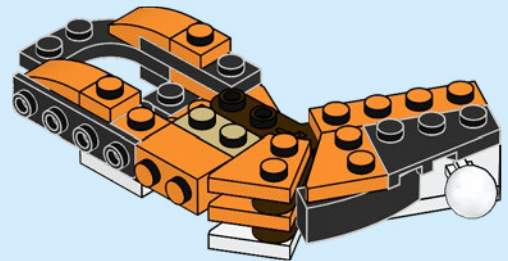



1x



1x

# 234

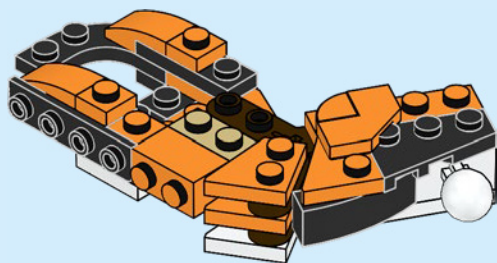

1x

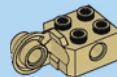

1x

# 235

CLICK KLICK  
CLIC CLIQUE  
KATT KLIKŠKIS  
咔嗒

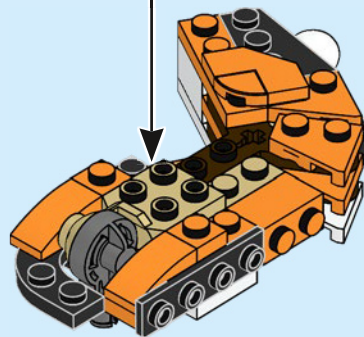
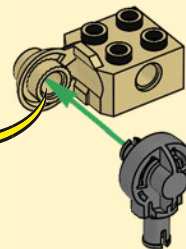



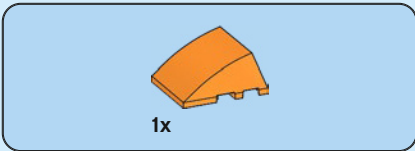

236

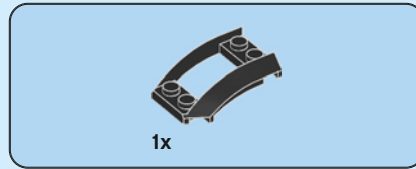
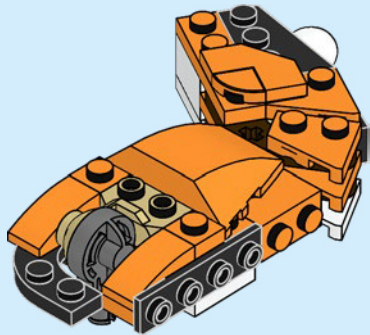

237

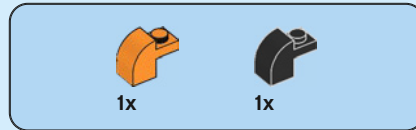
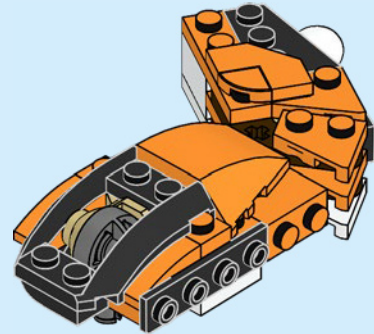

238

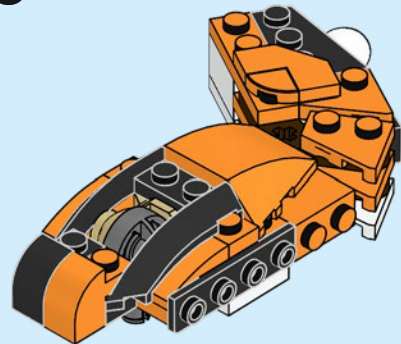

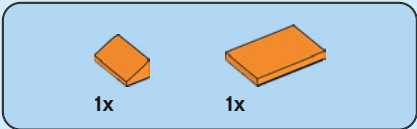

# 239

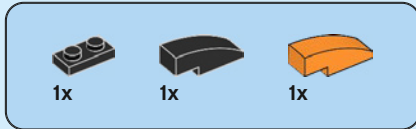
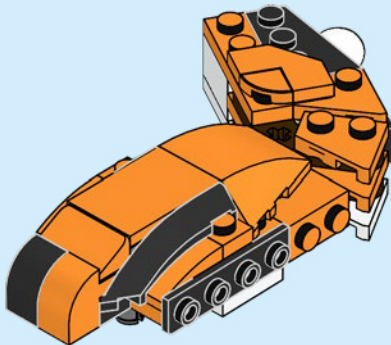

# 240

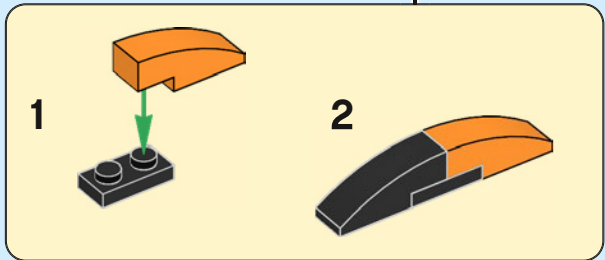
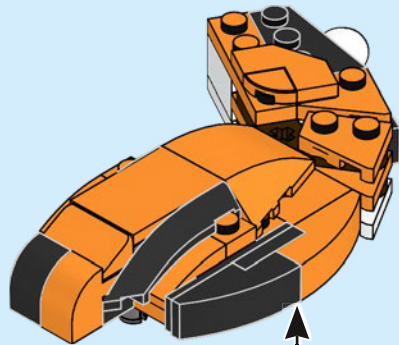



1x



2x

# 241

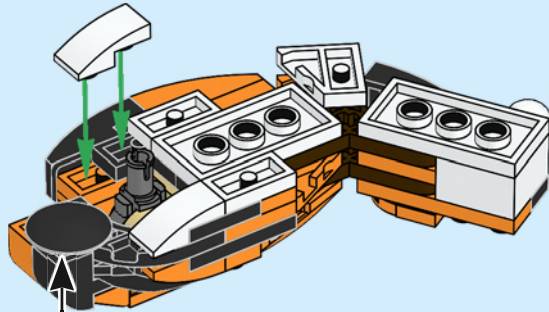
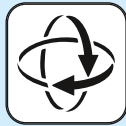



1x



1x

# 242

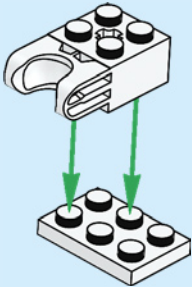

1x



1x

# 243

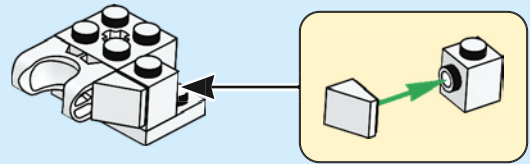

1x

# 244

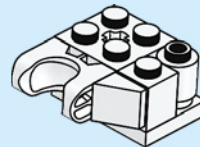



1x



1x

# 245

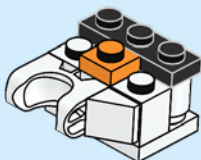

1x

# 246

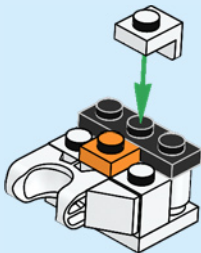

3x

# 247

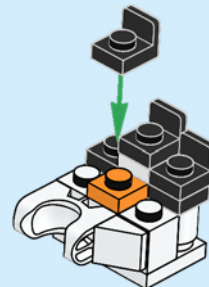

3x

# 248

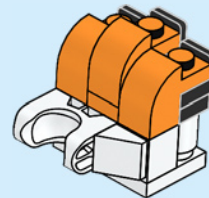

3x

249

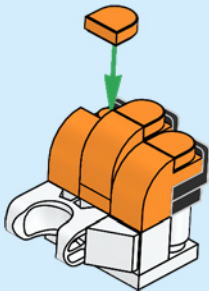

250

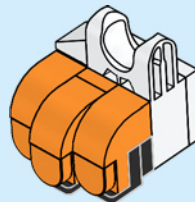

251

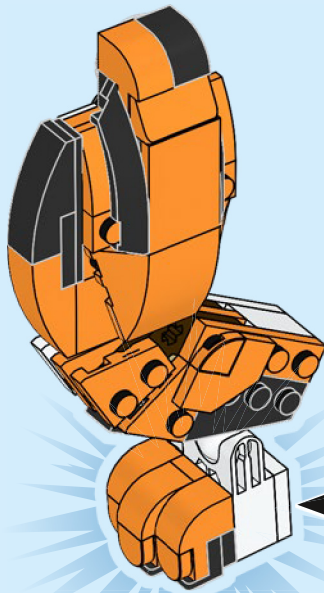

252

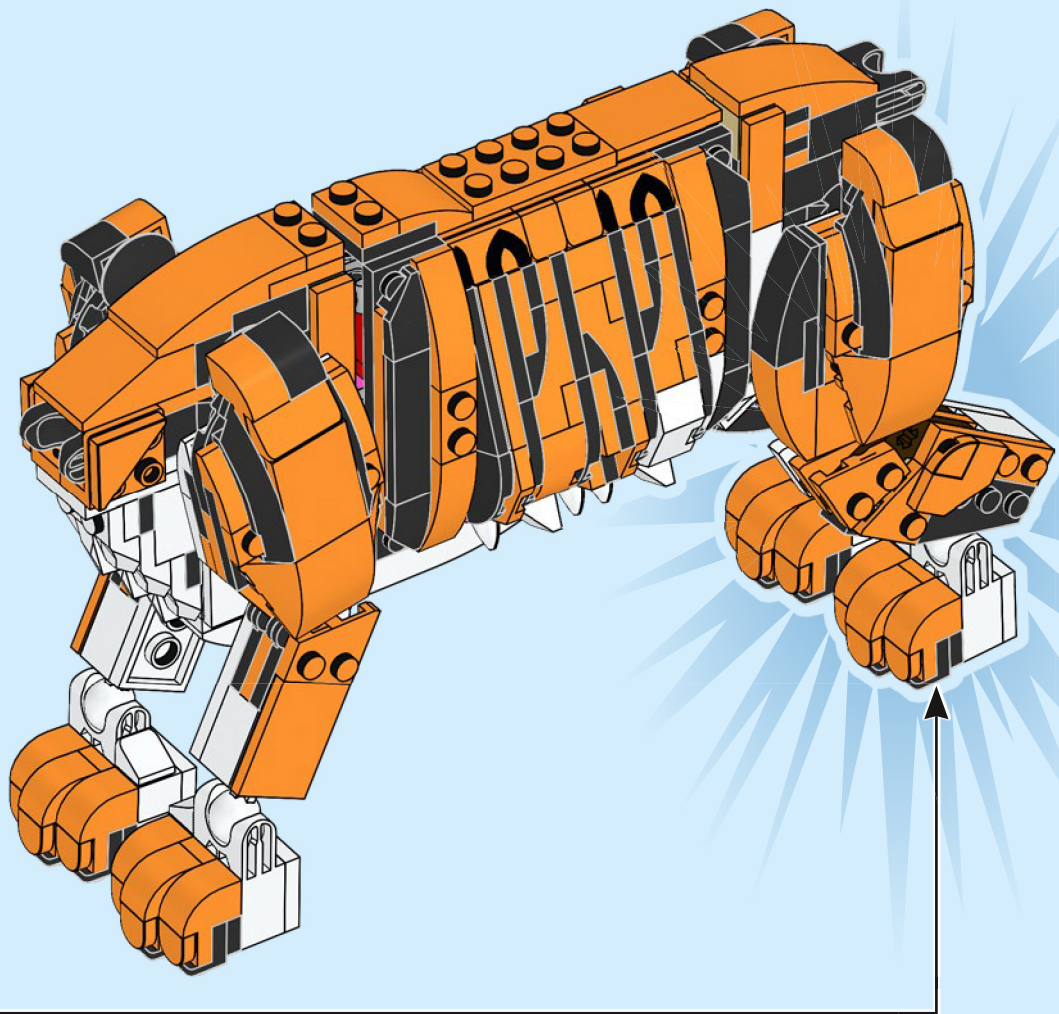

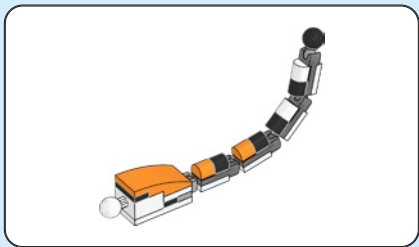
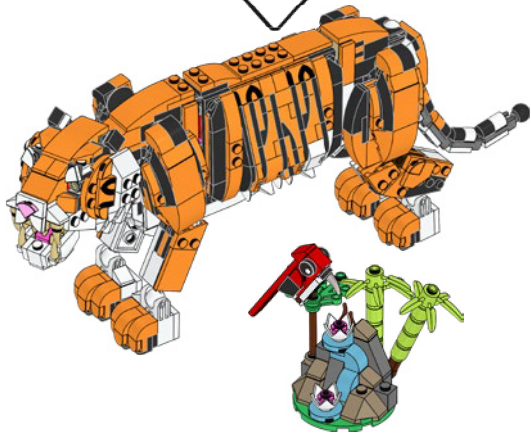

1x

**253**

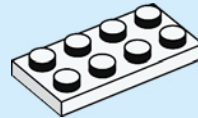

1x



1x

**254**

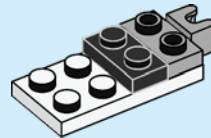





1x

**255**

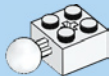
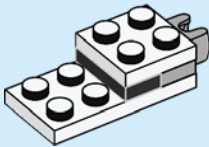

1x

**256**

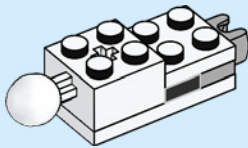

1x

**257**

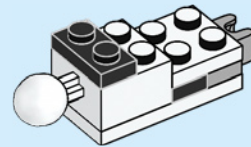

1x

**258**

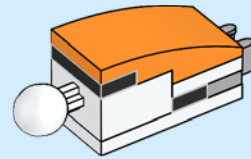



# 259

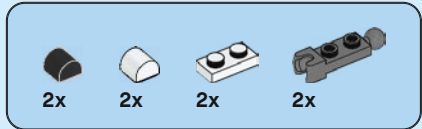
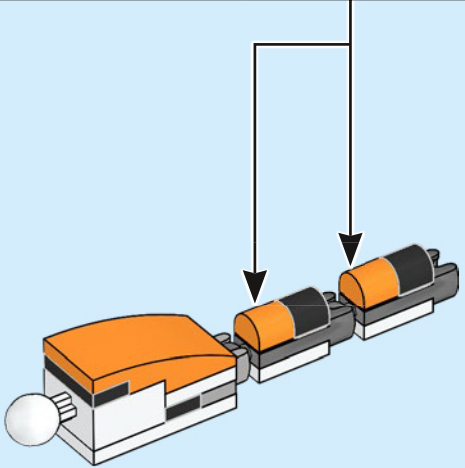
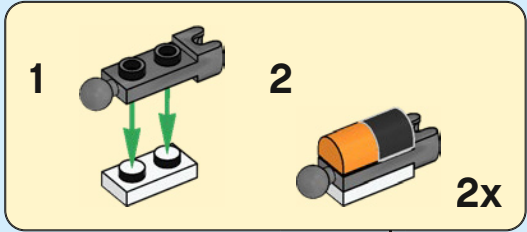

# 260

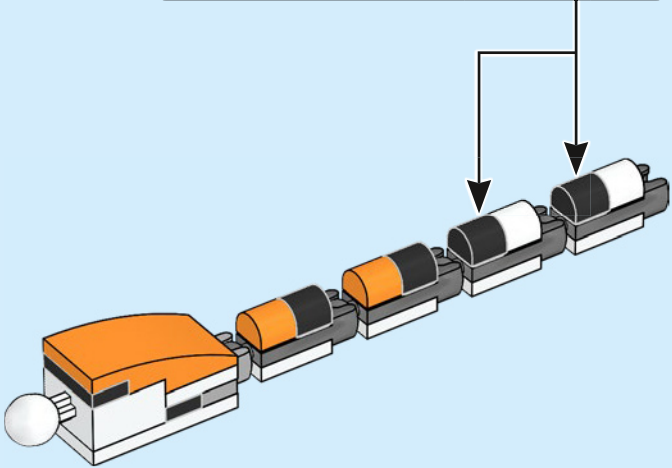
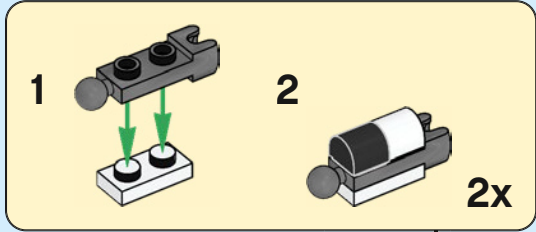



1x



1x

# 261

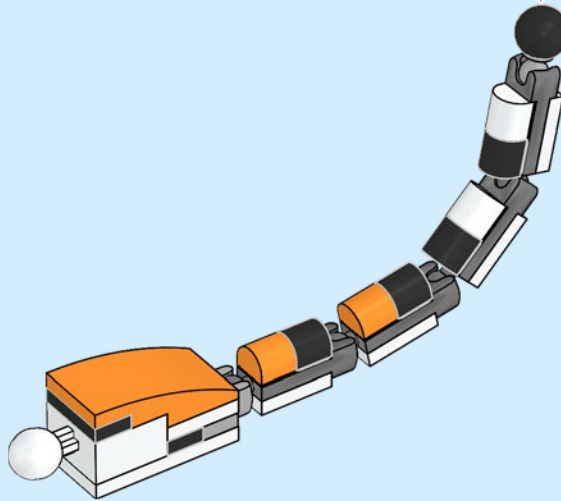
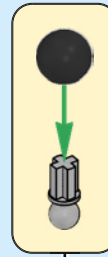

262

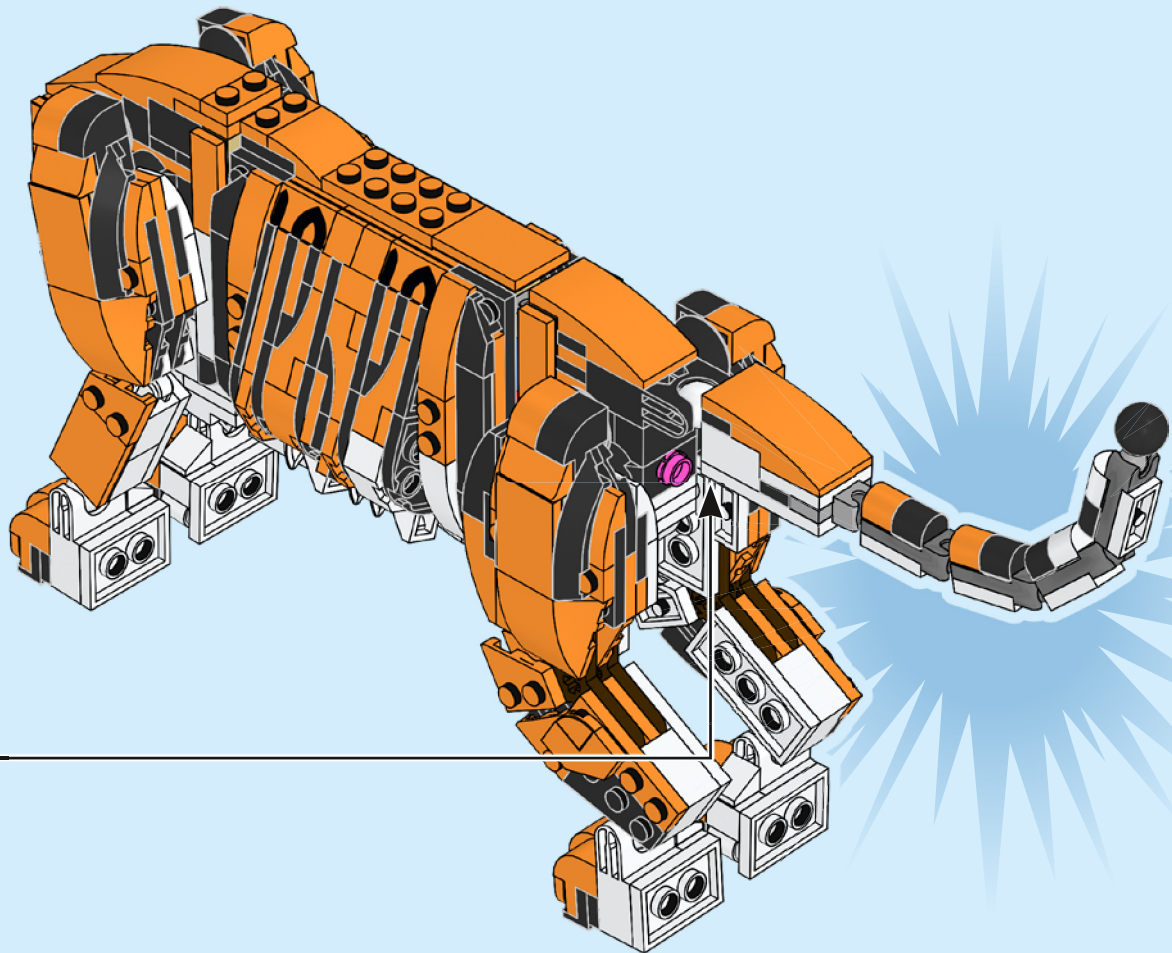

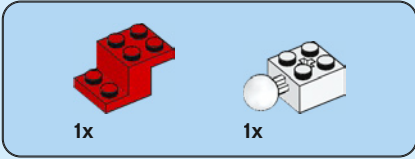
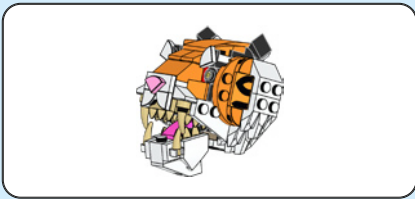

263

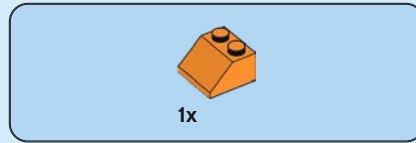
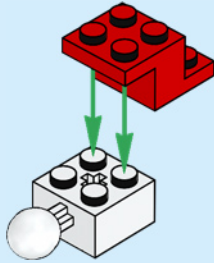

264

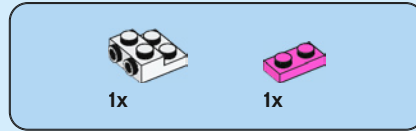
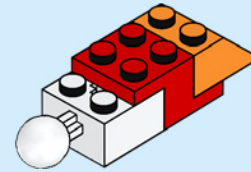

265

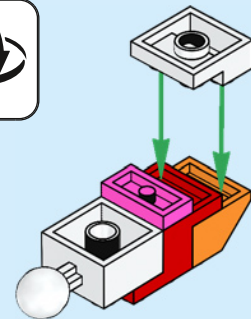
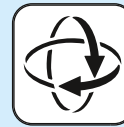



2x

# 266

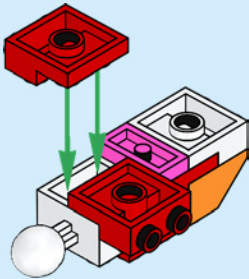

1x

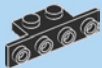

2x



1x

# 267

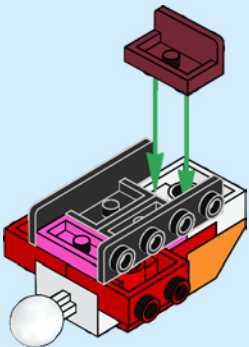

1x

# 268

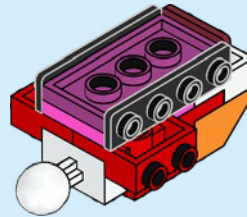

2x

# 269

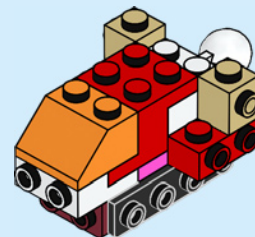



4x



2x

# 270

1



2



2x

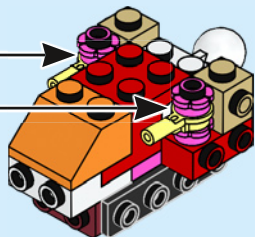

2x



2x



2x



2x

# 271

1



2



3



2x

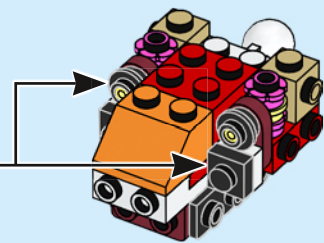

2x

# 272

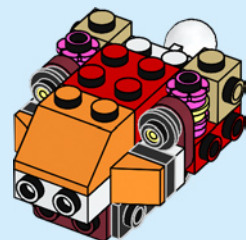



2x

# 273

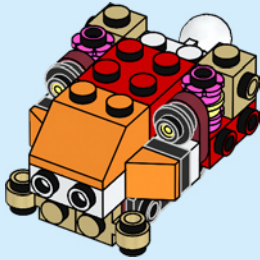

2x

# 274

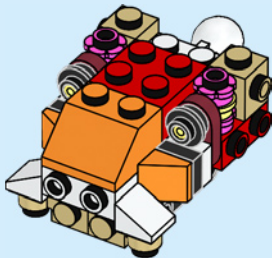

2x



3x

# 275

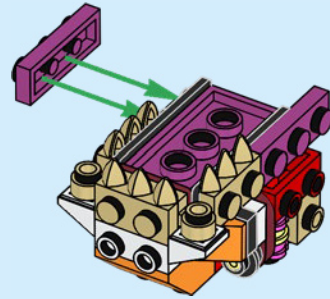

1x



2x



2x

# 276

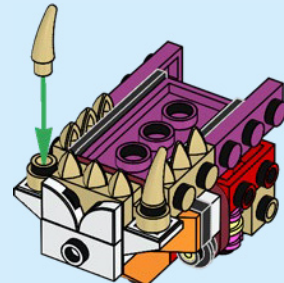



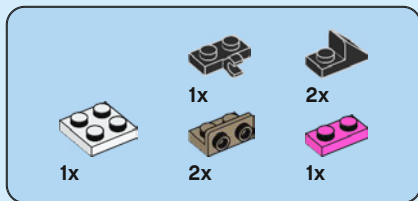

277

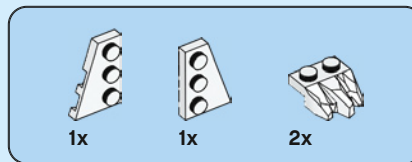
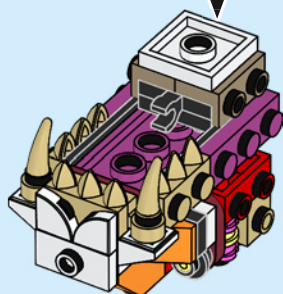
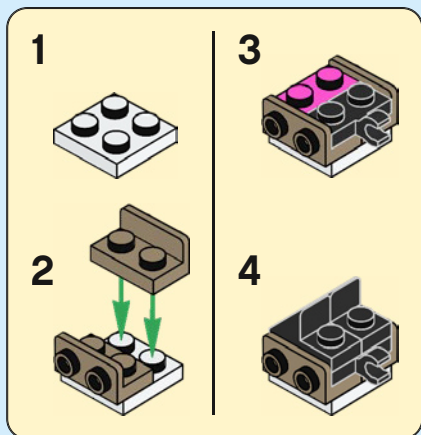

278

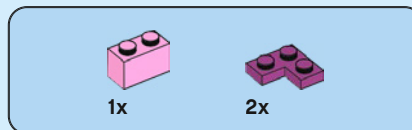
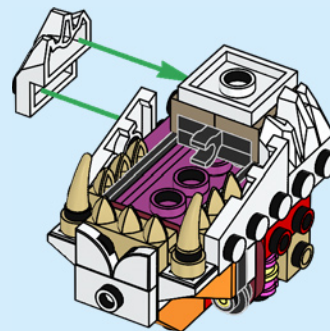

279

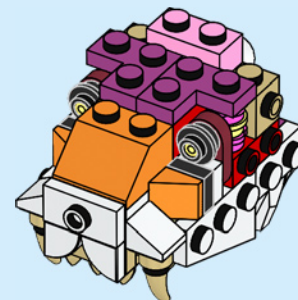



280

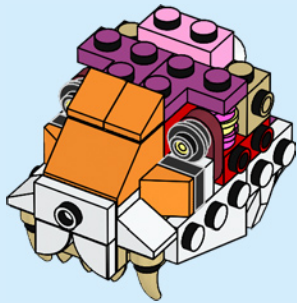

281

1



2

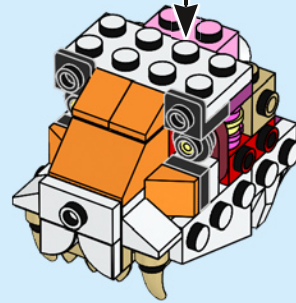
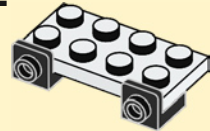



2x



1x

# 282

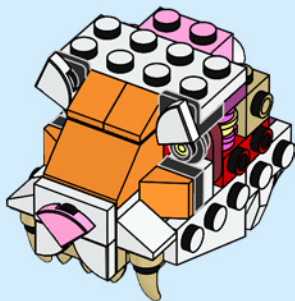

2x



2x

# 283

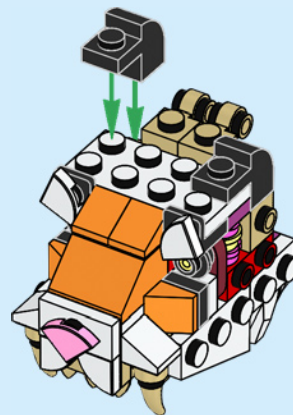



1x



1x

# 284

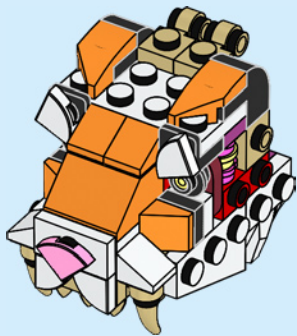

1x



2x

# 285

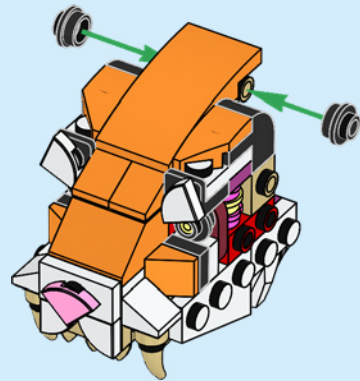



2x



2x



2x

# 286

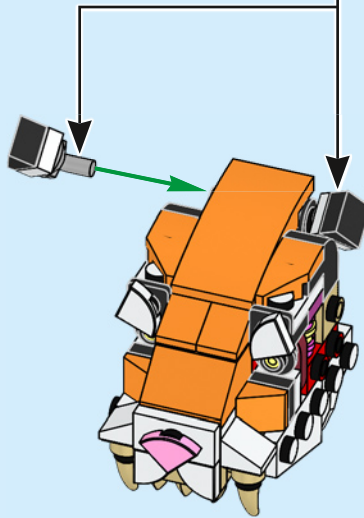
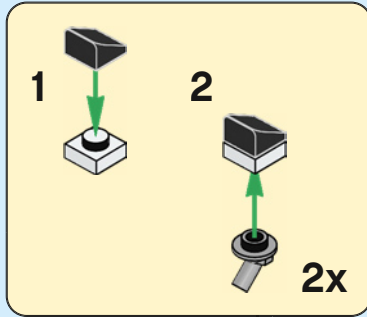

# 287

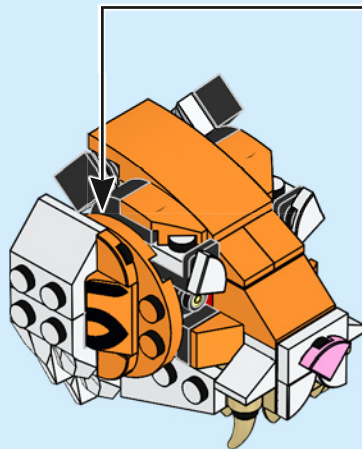
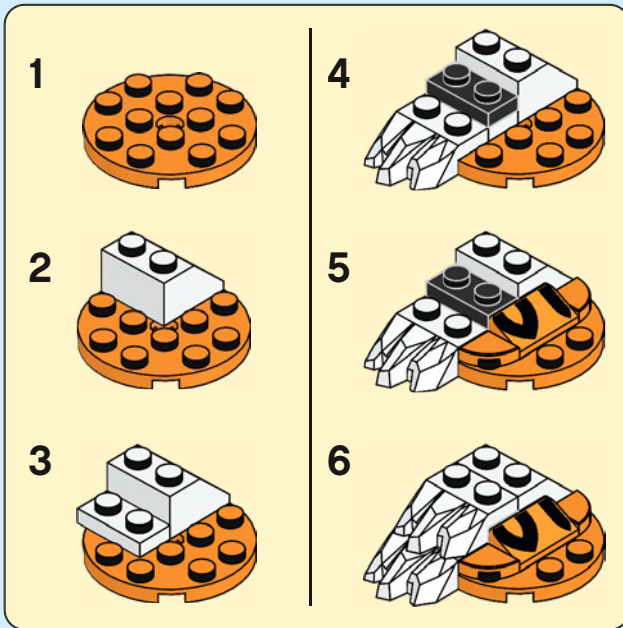
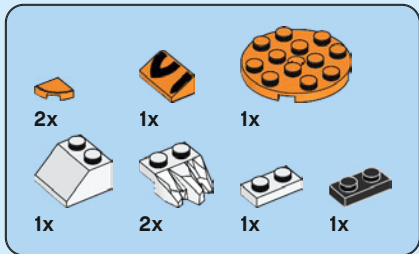

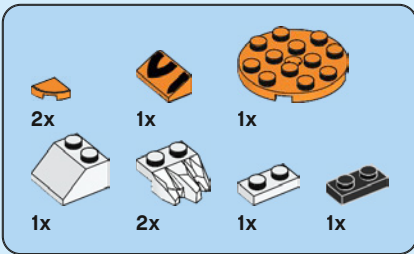

288

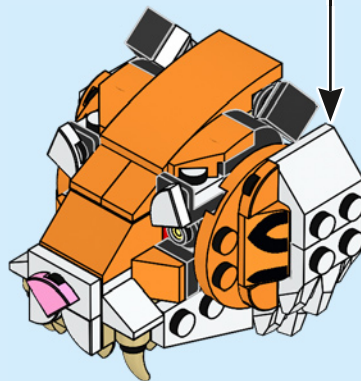
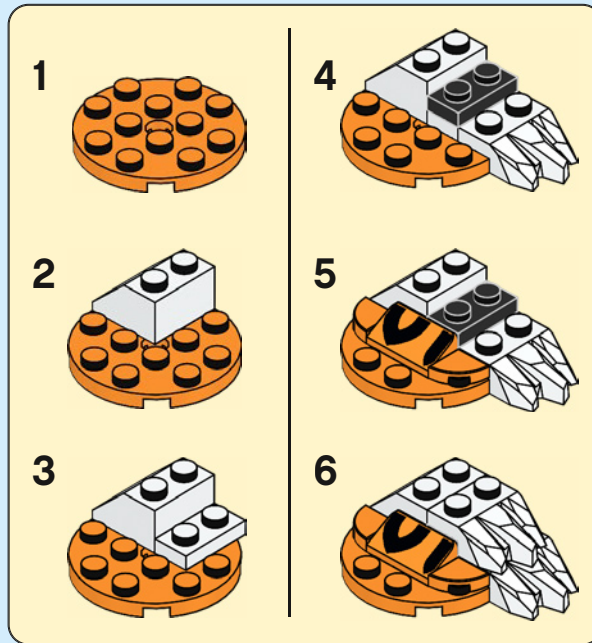

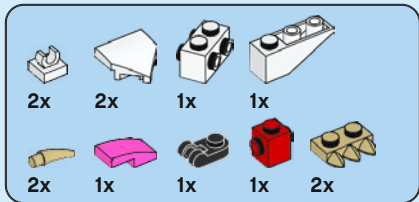

# 289

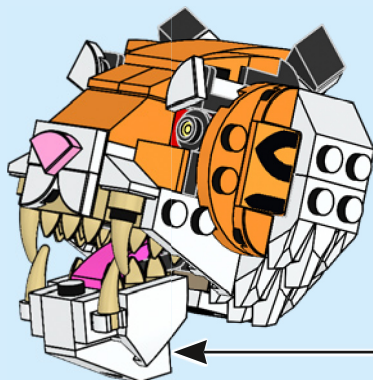
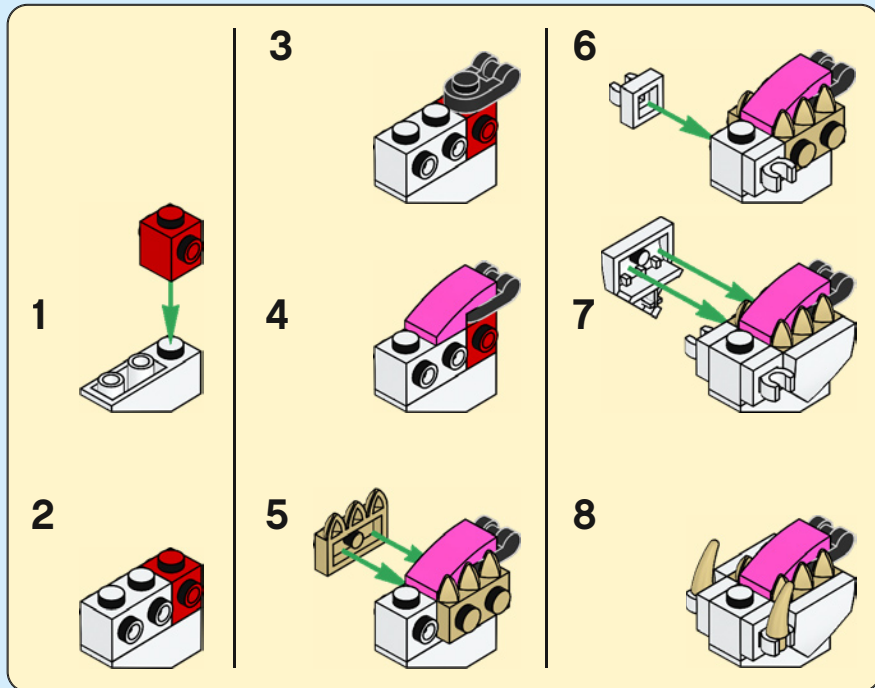



290

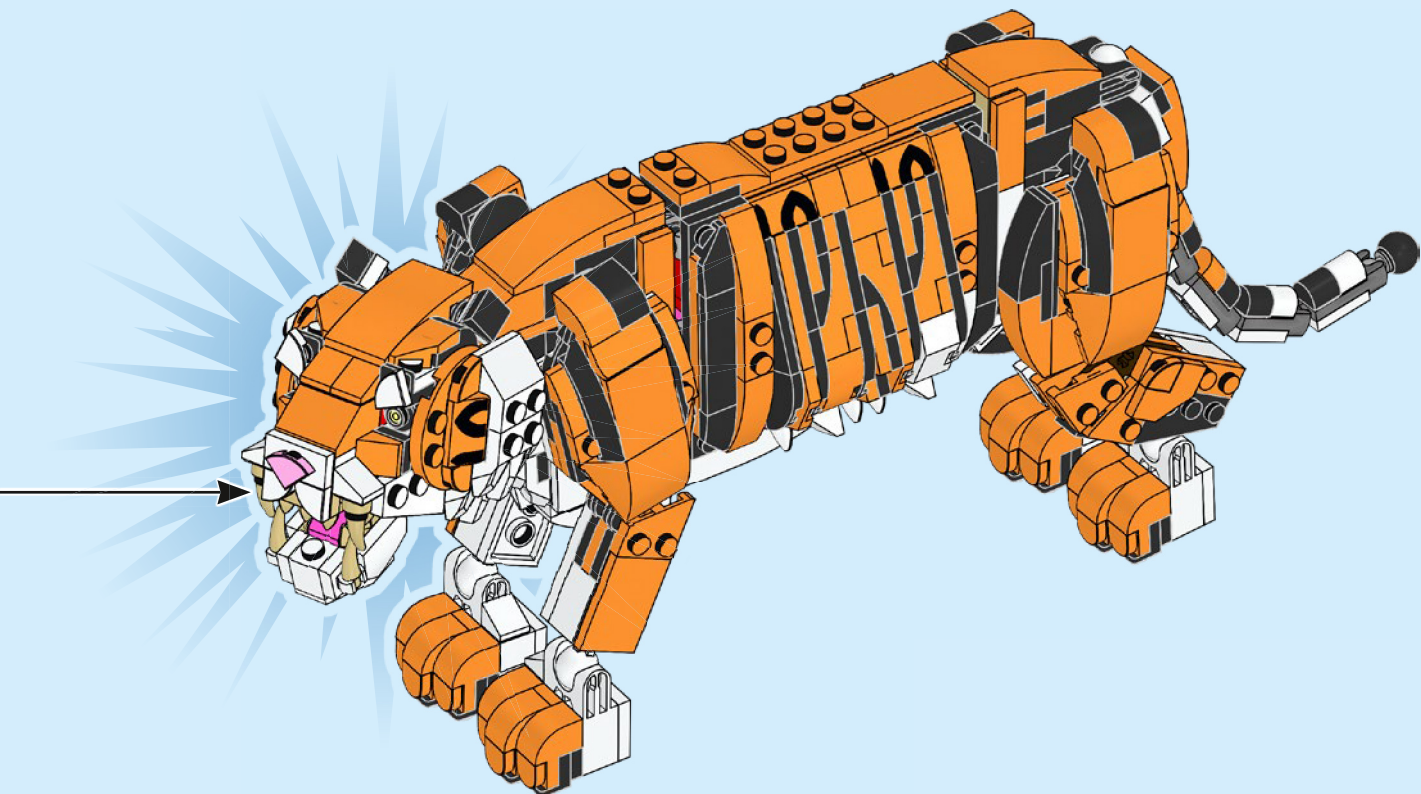

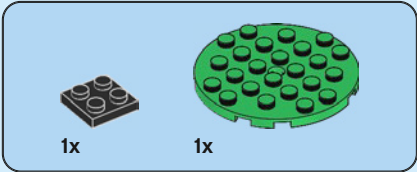

1

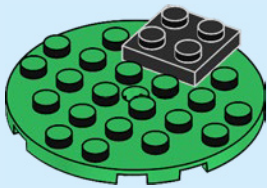

2

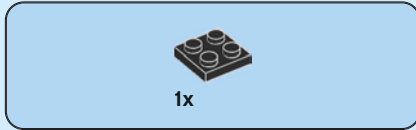
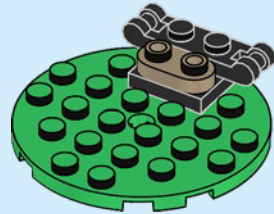

3

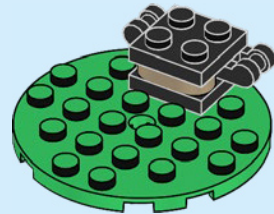



2x

4

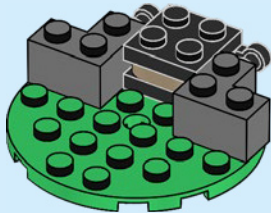

1x



1x

5

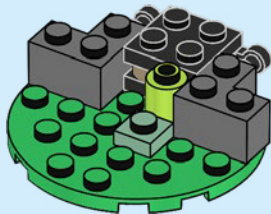

3x

6

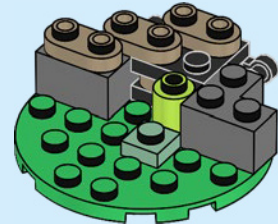

1x

7

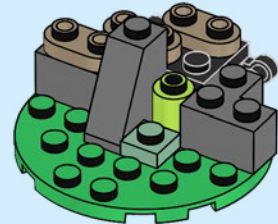

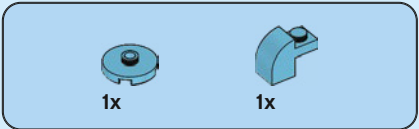

8

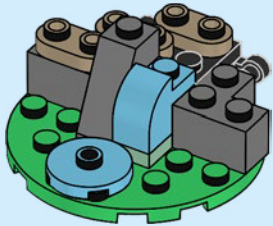

9

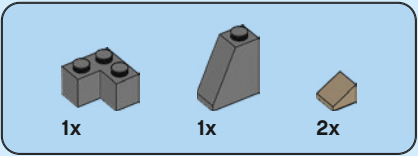
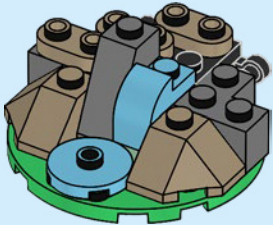

10

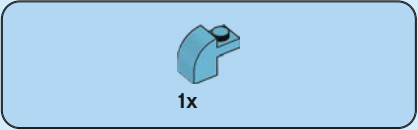
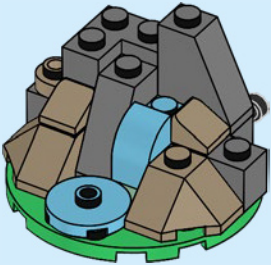

11

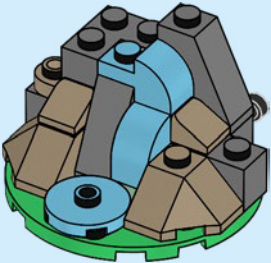

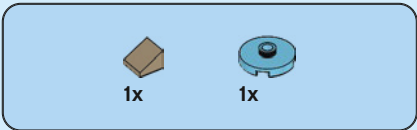

12

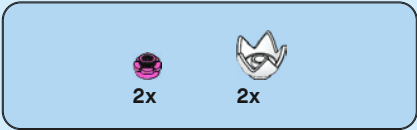
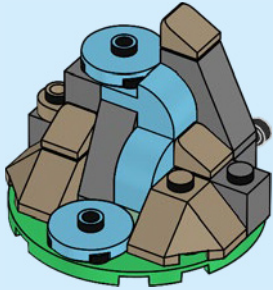

13

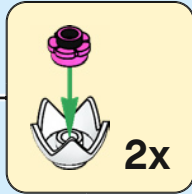
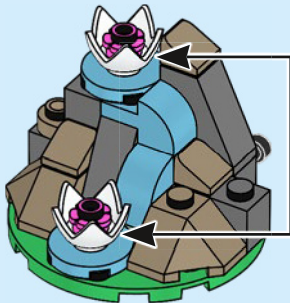

14

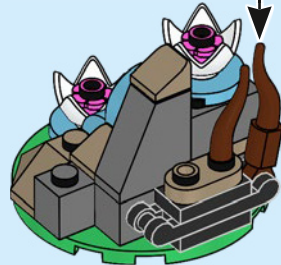
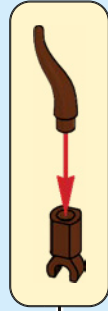

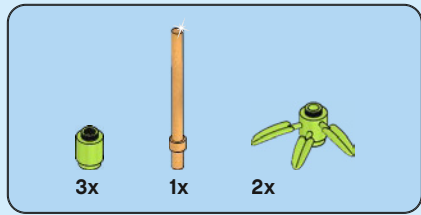

15

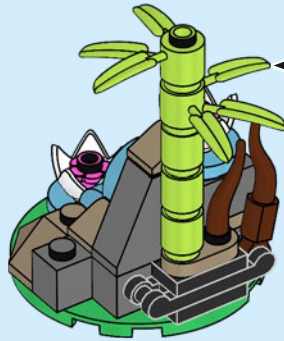
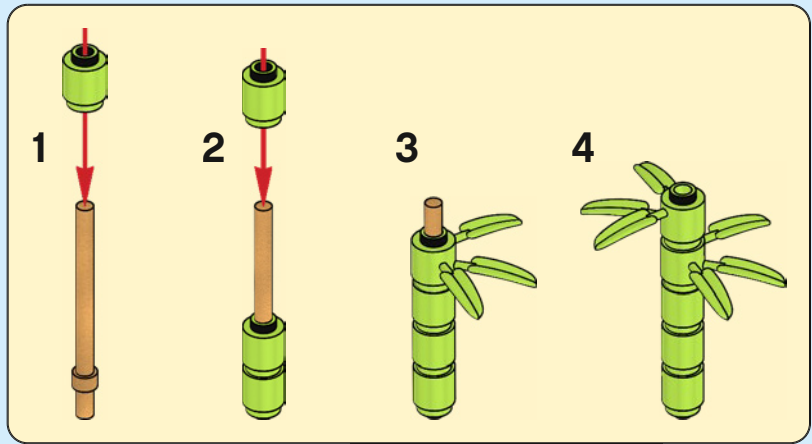

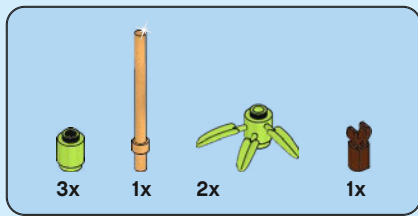

16

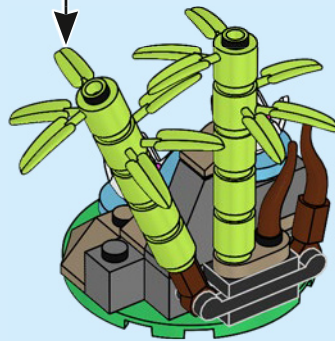
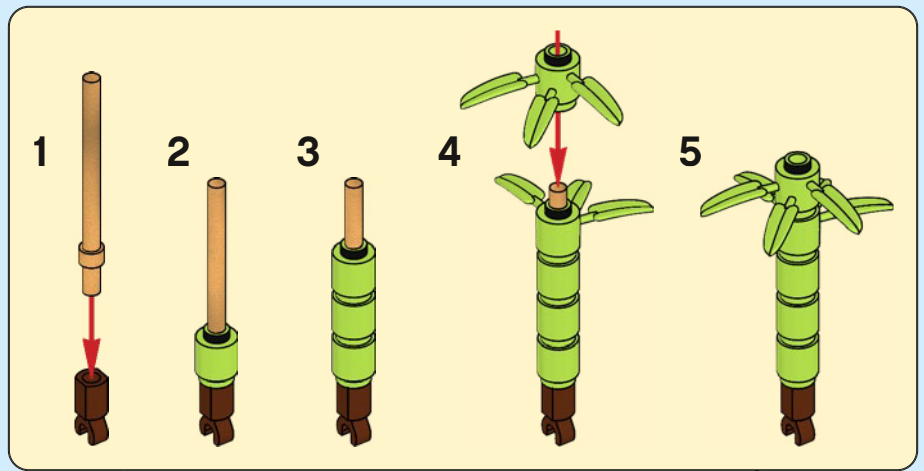



17

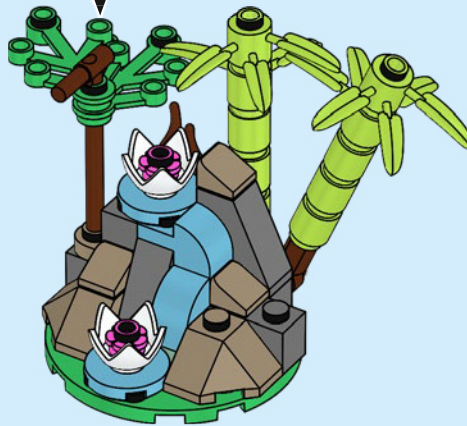
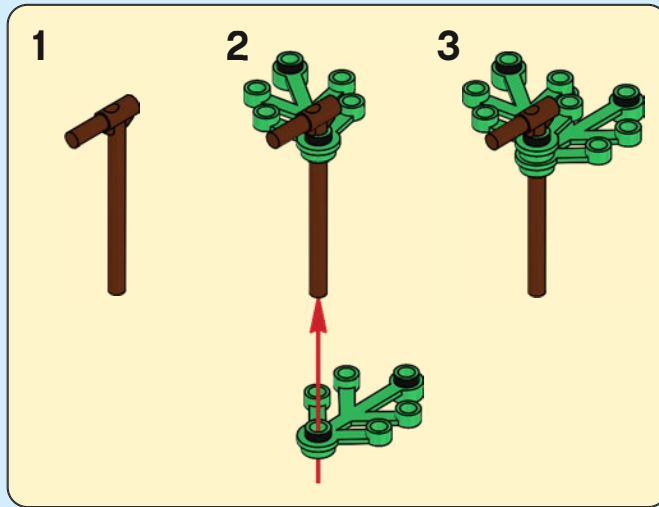



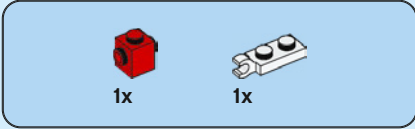

18

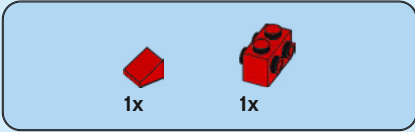
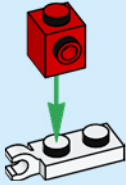

19

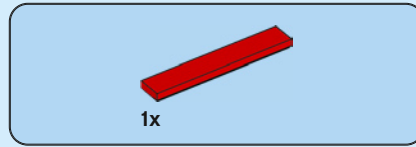
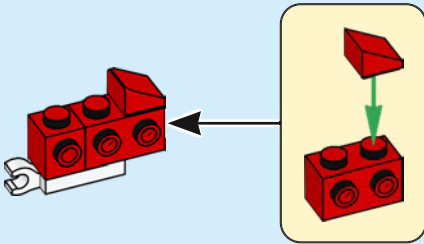

20

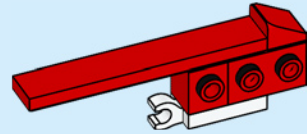

21

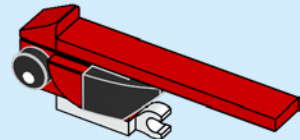
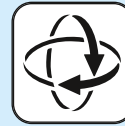



22

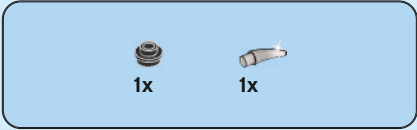
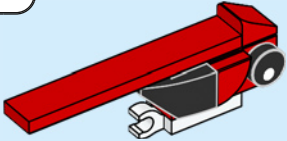

23

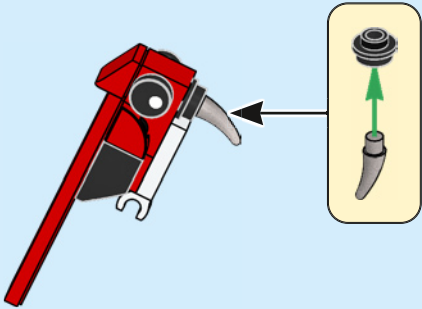

24



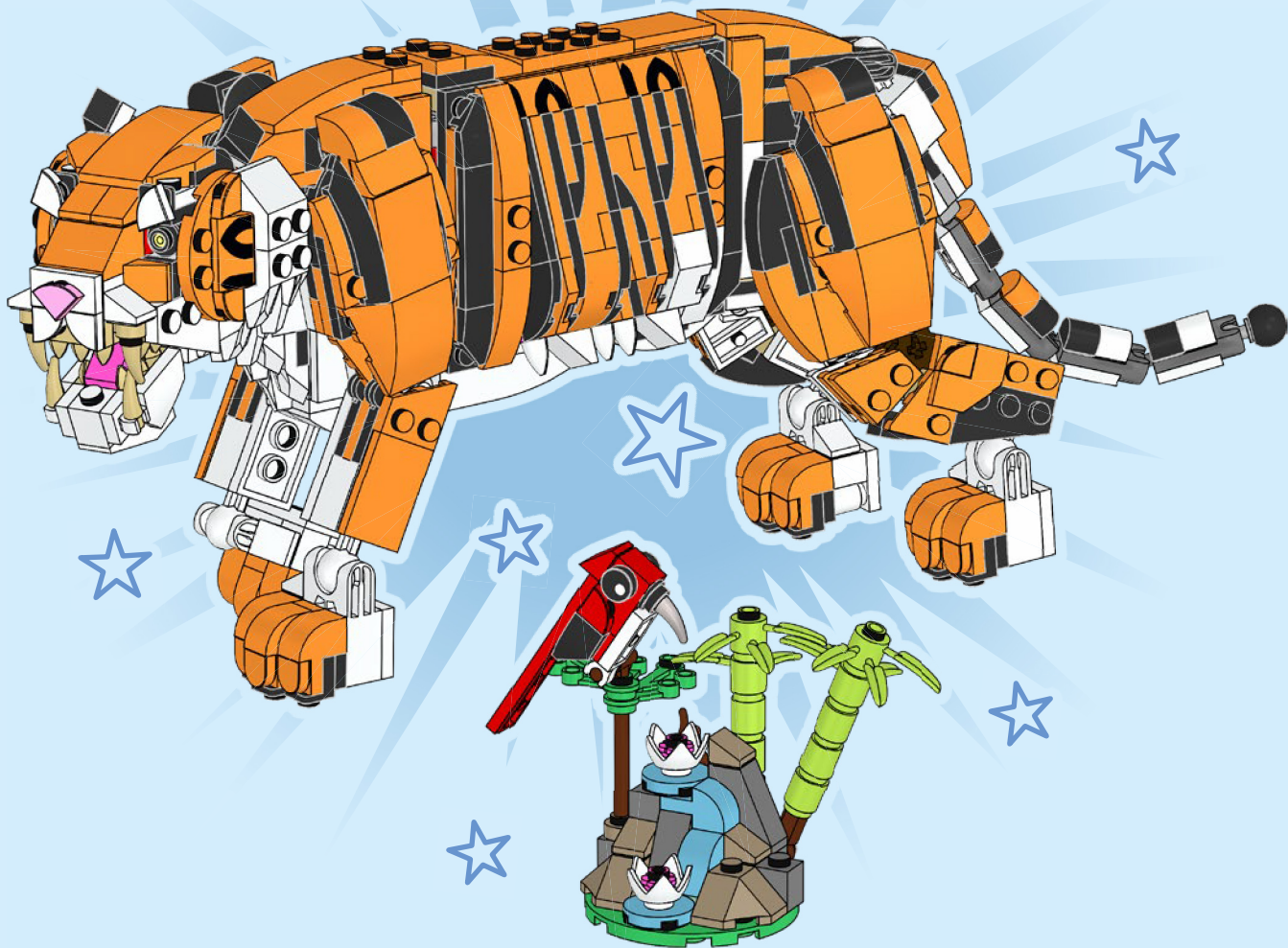



# CREATOR™

# 3 IN 1

**A tiger's stripes serve as camouflage in tall grass and bushes. The colours and spacing vary between subspecies and no two tigers have identical stripes.**

Die Streifen tarnen den Tiger im hohen Gras. Die Farben und der Abstand der Streifen unterscheiden sich von Unterart zu Unterart. Keine zwei Tiger besitzen dasselbe Streifenmuster.

Ses rayures permettent au tigre de se camoufler dans les hautes herbes et les buissons. Leur couleur et leur espacement varient d'une sous-espèce à une autre, et chaque tigre a des rayures uniques.

Le strisce consentono alla tigre di mimetizzarsi nell'erba alta e nei cespugli. I colori e la distanza variano tra le sottospecie e non esistono due tigri con strisce identiche.

Las rayas del tigre le sirven para camuflarse entre la hierba alta y los arbustos. Su color y separación varían según la subespecie y no hay dos tigres con rayas idénticas.

As riscas do tigre servem de camuflagem no capim e arbustos. As cores e o espaçamento variam entre subespécies e não há dois tigres com riscas idênticas.

A tigris csíkjai álcaként szolgálnak, elrejtik őt a magas fűben és a bozótban. A színek és a távolság alfajonként változik, és nincs két tigris egyforma csíkokkal.

Tīģera svītras palīdz maskēties garā zālē un krūmos. Svītru krāsa un izvietojums dažādām pasugām atšķiras, un nav divu tīģeru ar vienādām svītrām.

老虎身上的条纹在茂密的草丛和灌木丛中可以起到伪装作用。老虎身上条纹的颜色和间距因其种类的不同而异，没有任何两只老虎拥有相同的条纹。

**Despite their bright fur, tigers can easily sneak up on their prey. Deer and most other prey animals are colour blind and just see the orange fur as green vegetation.**

Trotz ihres leuchtenden Fells können Tiger ihrer Beute leicht auflauern. Die meisten Beutetiere sind farbenblind und können das orange Fell nicht von grünen Pflanzen unterscheiden.

Malgré la couleur de sa fourrure, le tigre peut facilement passer inaperçu. Les cerfs et la plupart de ses autres proies étant daltoniens, ils confondent sa fourrure orange avec la végétation verte.

Nonostante il loro manto appariscente, le tigri riescono facilmente a sorprendere le loro prede. I cervi e la maggior parte degli animali da preda sono daltonici e il manto arancione della tigre appare loro come vegetazione di colore verde.

A pesar de su llamativo pelaje, los tigres saben acercarse sigilosamente a sus presas. Los ciervos y la mayoría de los animales de presa son daltónicos y el pelo naranja les parece vegetación verde.

Apesar do pelo brilhante, os tigres podem aproximar-se furtivamente das suas presas. Os veados e a maioria dos outros predadores são daltónicos e veem o pelo laranja como se fosse vegetação verde.



Élénk színű bundájuk ellenére a tigrisek könnyen a zsákmányuk közelébe lopózkodhatnak. A szarvasok és a zsákmányállatok többsége színvak, és a narancssárga tigriszőrt zöld növényzetnek látják.

Kaut arī tīģeriem ir košs kažoks, tie var viegli pielavīties medījumam. Briēži un daudzi citi medijamie dzīvnieki neatšķir krāsas, tāpēc tie oranžo kažoku redz tāpat kā zaļos augus.

尽管老虎的皮毛非常鲜亮，但它们却很容易偷袭到猎物。这是因为鹿和大多数其他猎物都是色盲，会把金黄色皮毛看作绿色的植被。







## A tiger doesn't roar often, but when it does, it can be heard up to 3 kilometres away!

Ein Tiger brüllt nicht oft, ist aber dafür noch in 3 km Entfernung zu hören!

Le tigre ne rugit pas souvent, mais lorsqu'il le fait, on l'entend à 3 km à la ronde !

Una tigre non ruggisce spesso, ma quando lo fa può essere udita fino a 3 chilometri di distanza!

Los tigres no rugen a menudo, pero, cuando lo hacen, ¡se les puede oír hasta a 3 km de distancia!

Um tigre não ruge com frequência, mas quando o faz, pode ser ouvido a 3 km de distância!

A tigris nem üvölt gyakran, de ha igen, akkor akár 3 km-re is elhallatszík!

Tígeris rēc reti, bet tā rēcienu var dzirdēt pat 3 km attālumā!

老虎不经常吼叫, 但当它吼叫时, 声音会传到 1.9 英里之外!

## 2022 is the Year of the Tiger in the Chinese Zodiac calendar.

2022 ist das Jahr des Tigers im chinesischen Kalender.

2022 est l'année du Tigre dans l'astrologie chinoise.

Il 2022 è l'Anno della Tigre nello zodiaco cinese.

2022 es el Año del Tigre en el Zodiaco chino.

2022 é o Ano do Tigre no Zodiaco chinês.

2022 a tigris éve a kínai horoszkóp szerint.

Pēc ķīniešu zodiaka kalendāra 2022. gads ir tīģera gads.

2022 年是中国虎年。



 8x 4504369	 4x 243101	 4x 306201	 6x 4224792	 4x 6230579	 2x 6013658	 7x 4212454	 2x 303421
 4x 6172366	 1x 6132204	 2x 6258135	 2x 6330191	 2x 4518892	 3x 4211109	 4x 6175572	 2x 614321
 2x 6301907	 1x 300301	 1x 6361170	 1x 428701	 1x 6210310	 4x 6338166	 2x 6315482	 2x 6030266
 1x 6051511	 2x 6198933	 4x 6296132	 2x 6034675	 2x 6212040	 4x 4522784	 4x 6290531	 1x 4113858
 15x 302301	 14x 302001	 4x 4558952	 1x 4667575	 1x 6264026	 4x 6338168	 14x 4579260	 6x 6187620
 8x 6172927	 4x 302101	 2x 6348055	 2x 4160403	 17x 6209679	 11x 6338165	 6x 6024495	 1x 4569056
 4x 6218823	 2x 6156667	 2x 6210385	 4x 4121932	 11x 6057387	 2x 6326748	 5x 6046907	 1x 4504379
 1x 6097637	 2x 6259700	 1x 6132203	 2x 4249112	 3x 6132918	 1x 4211375	 4x 6063671	 2x 6170390
 10x 6181319	 4x 302401	 1x 4179875	 2x 6137926	 1x 6289701	 2x 6341968	 6x 4218749	 2x 6061711
 6x 302201	 1x 6053026	 1x 4179874	 1x 6240463	 2x 6296963	 1x 6214343	 4x 6281995	 1x 6172642
 6x 6307640	 1x 4179874	 1x 383201	 4x 6096589	 2x 6170470	 2x 6269077	 12x 4516055	 1x 6313116
 4x 6360826	 2x 303901	 1x 4517993	 1x 4517993	 2x 6170470	 4x 6328094	 4x 6375375	 2x 6296186



4x  
4525236



4x  
6325190



2x  
4504382



6x  
6359224



2x  
6191630



2x  
6360825



6x  
6184784



1x  
4290713



4x  
4278359



4x  
6273589



5x  
6181720



5x  
6181713



22x  
362326



4x  
4251161



14x  
6234695



4x  
6172383



8x  
4227392



5x  
6168646



8x  
302426



4x  
6168620



1x  
6157554



6x  
6069000



12x  
302326



6x  
6147050



2x  
6141556



2x  
6141556

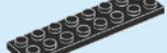

4x  
303426



1x  
6099483



4x  
6102782



2x  
6141554



4x  
302226



10x  
300426



6x  
243126



2x  
6284072



8x  
242026



1x  
4180536



1x  
4180536



1x  
4180508



12x  
4118782



4x  
4118828



4x  
6329309



1x  
6067913



2x  
6061676



1x  
4121742



1x  
4158355



8x  
6055069



6x  
6173925



6x  
6173928



6x  
6173933



2x  
6346092



1x  
6177490



1x  
6177499



4x  
6054529



4x  
6329309



2x  
4159007



2x  
6184997



6x  
4173332



2x  
4173805



6x  
6366029



6x  
4121739



4x  
4620693



17x  
4177932



7x  
6293710



26x  
4524929



8x  
4251969



2x  
6289374



4x  
6218367



2x  
6226926



8x  
4504371



12x  
6344851



2x  
6278436



6x  
6366029



6x  
4121739



4x  
6068996



2x  
6022048



16x  
6112356



8x  
4251969



4x  
6179916



6x  
6375376



2x  
6331865



4x  
6231386



3x  
6040126



2x  
6250168



1x  
6037658



2x  
6022048



4x  
6179916



2x  
6335566



2x  
6136419



1x  
6099189



1x  
6270108



1x  
6097413



2x  
6268814



1x  
6254100



Customer Service

Kundenservice

Service Consommateurs

Servicio Al Consumidor

LEGO.com/service or dial



: 00800 5346 5555

: 1-800-422-5346

# WIN

GO TO [WWW.LEGO.COM/PRODUCTFEEDBACK](http://WWW.LEGO.COM/PRODUCTFEEDBACK) AND  
GIVE US YOUR SHORT **FEEDBACK** ABOUT THIS  
LEGO® SET FOR A CHANCE TO WIN  
A COOL LEGO PRIZE.

Terms & Conditions apply



## [LEGO.com/productfeedback](http://LEGO.com/productfeedback)

### GEWINNE

Erzähle uns auf  
[www.LEGO.com/productfeedback](http://www.LEGO.com/productfeedback)

etwas über die Erfahrungen, die du mit  
diesem LEGO® Set gemacht hast, und  
sichere dir die Chance auf einen coolen  
LEGO Preis!

Es gelten die Teilnahmebedingungen

### GAGNE

Rends-toi sur  
[www.LEGO.com/productfeedback](http://www.LEGO.com/productfeedback)

et donne-nous quelques commentaires  
sur ce produit LEGO® pour avoir une  
chance de gagner un prix LEGO !

Voir Conditions Générales

### GANANA

Visita  
[www.LEGO.com/productfeedback](http://www.LEGO.com/productfeedback)

y envíanos tu opinión acerca de este  
set LEGO®. ¡Participarás en el sorteo de  
un premio LEGO!

Términos y Condiciones aplicables

### 获取奖品

登录  
[www.LEGO.com/productfeedback](http://www.LEGO.com/productfeedback)

给出关于此乐高®套装的简短反馈，  
就有机会获得炫酷乐高奖品

《条款及条件》适用

LEGO and the LEGO logo are trademarks of the LEGO Group. ©2022 The LEGO Group.