



AVATAR™

75576





FR
DONNEZ
OU
RECYCLEZ



ASSOCIATION

OU



MAGASIN

OU



DÉCHÈTERIE

Adresses sur quefairedemesdechets.fr



LEGO.com/sustainable-packaging

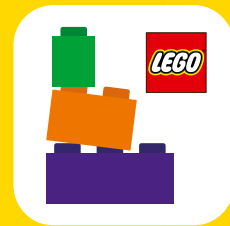

BUILDER



Apple and the Apple logo are trademarks of Apple Inc., registered in the U.S. and other countries and regions. App Store is a service mark of Apple Inc. Google Play and the Google Play logo are trademarks of Google LLC. Tencent and the Tencent logo are trademarks of Tencent Inc.

Q [LEGO.com/devicecheck](https://www.lego.com/devicecheck)

EN Ask parents' permission before going online | DE Eltern um Erlaubnis bitten, bevor du online gehst | FR Demande l'autorisation d'un parent avant d'aller en ligne | IT Chiedi il permesso ai tuoi genitori prima di andare online | ES Pídeles permiso a tus papás antes de conectarte a Internet | PT Peça autorização aos pais antes de acederes online | JA オンラインになる前に ほかの方のきよかもをもらおう | ZH 上网前应先征得父母的同意 | KO 온라인 접속 전에 보호자 동의가 필요합니다 | RU Спроси разрешения у родителей, прежде чем заходить в интернет | PL Poproś rodziców o zgodę, zanim wejdiesz do Internetu | CS Než půjdeš na internet, požádej rodiče o svolení | SK Než pôjdeš na internet, vypýtaj si povolenie od rodičov | HU Kérj szülői engedélyt, mielőtt online csatlakoznál! | RO Cere permisiunea părinților înainte de a te conecta online | BG Поискайте разрешение от родител, преди да влезете онлайн | LV Pirms došanās tiešsaistē palūdz atļauju vecākiem | ET Enne Interneti kasutamist küsi vanematelt luba | LT Prieš prisijungdami prie interneto, atsiklauskite tėvų



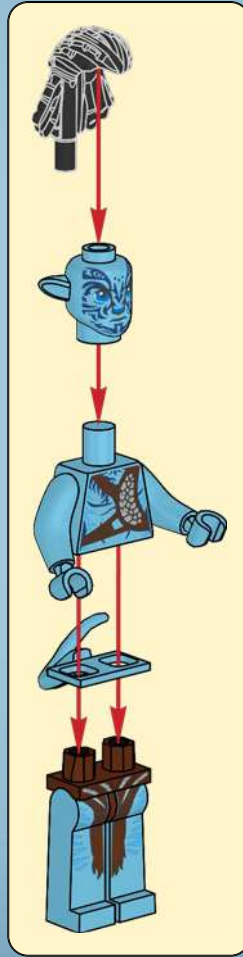



1x

1



1x

2



2x

3



1x



1x

4

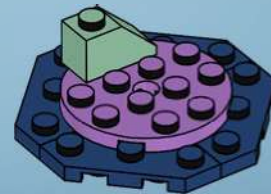



2x

5

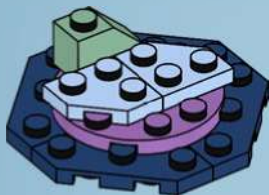

1x



1x

6

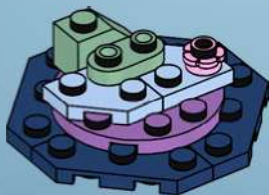

1x



1x

7

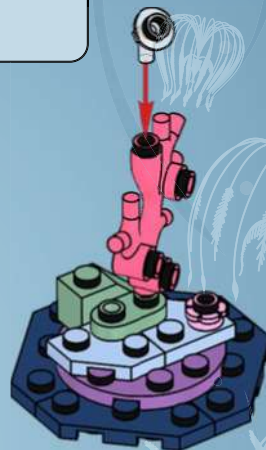

1x



1x

8









1

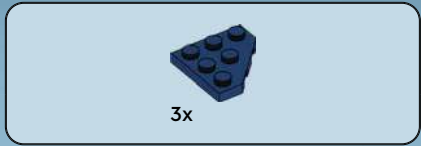

2



3





1x



1x

4



1x



1x



1x

5



2x



1x



1x

6

1

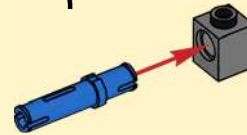

2



3

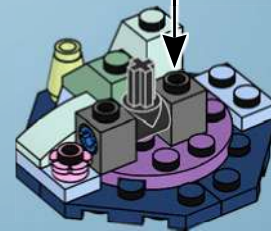



2x

7

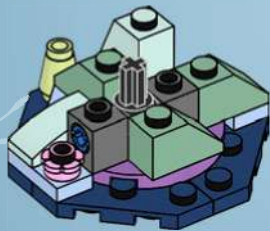

1x



1x



1x

8

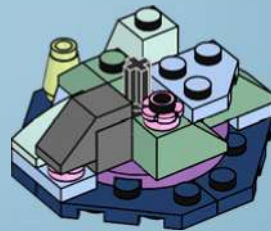



1x



1x



1x

9

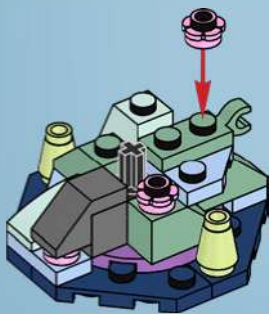

1x



1x



1x

10

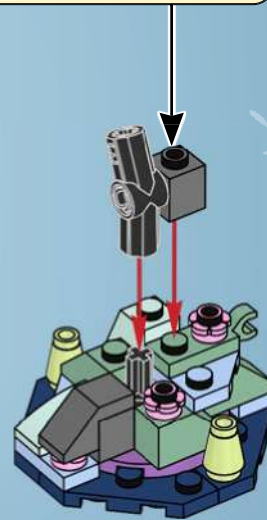
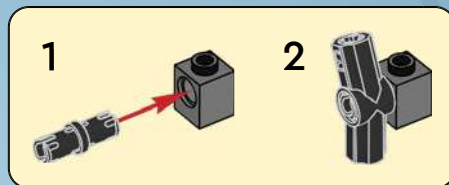



1x



1x



2x

11

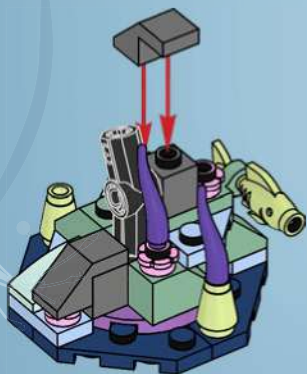

2x



1x

12

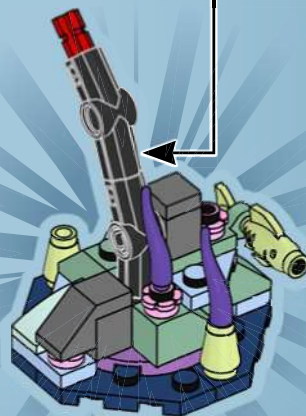
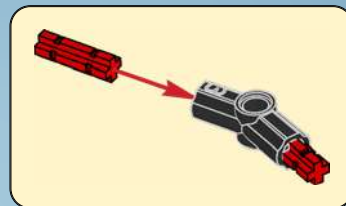

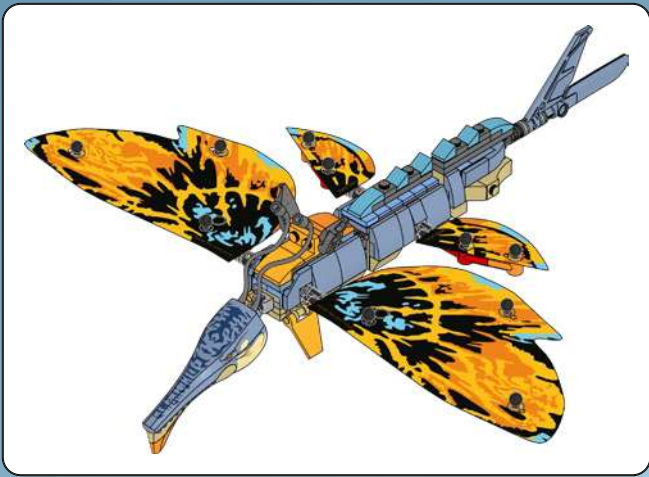

1x



1x

1

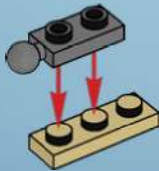

1x

2



1x



1x

3

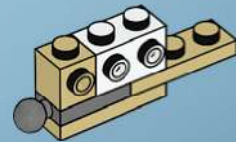

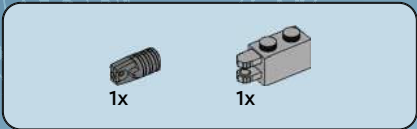

4

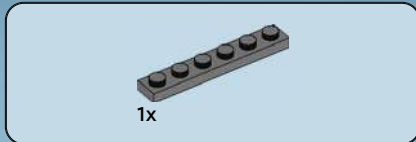
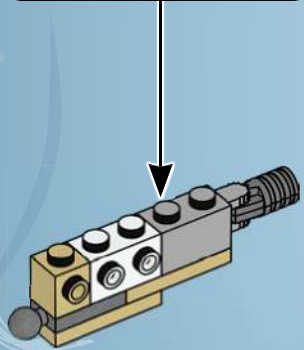
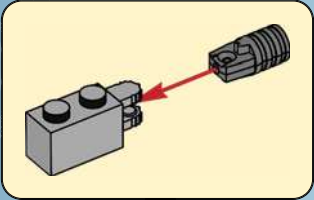

5

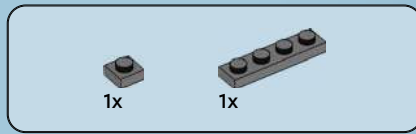
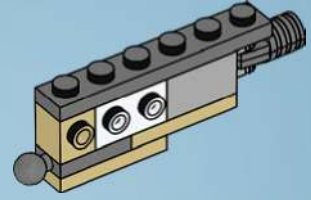

6

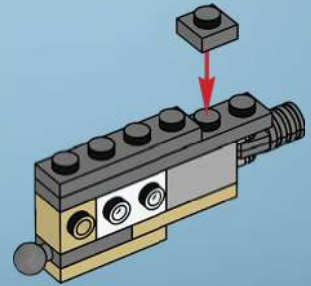



2x



2x



1x

7

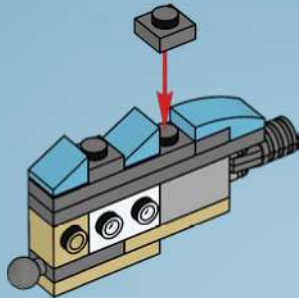

1x



1x

8

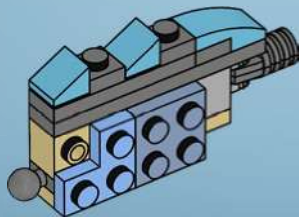

1x



1x

9

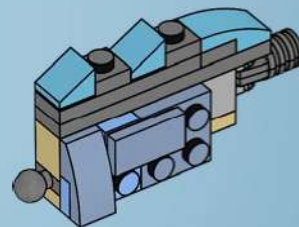



1x



1x

10

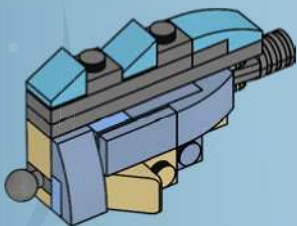

1x



1x

11

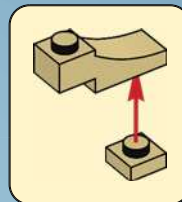
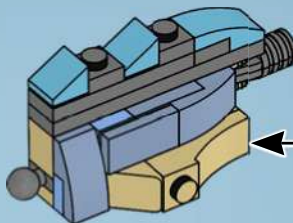

1x



1x

12

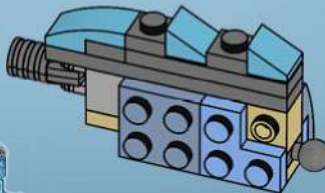



1x



1x

13

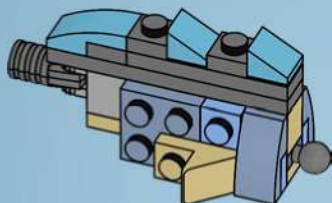

1x



1x

14

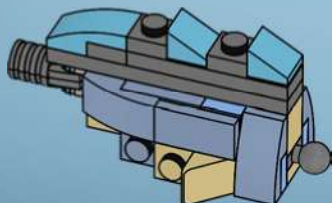

1x



1x

15

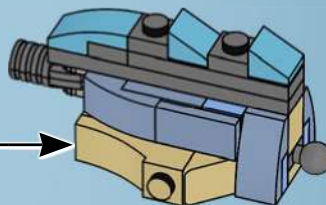
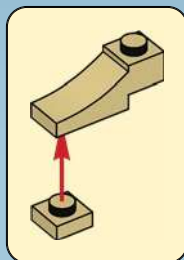

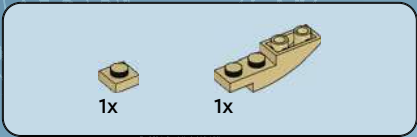

16

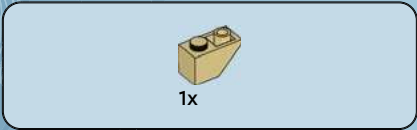
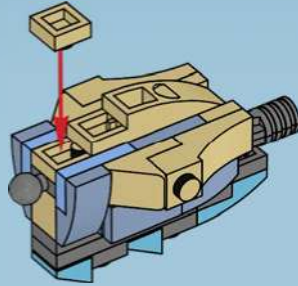

17

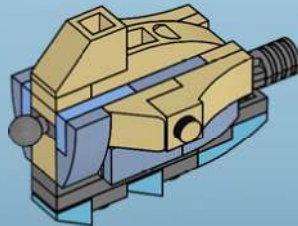

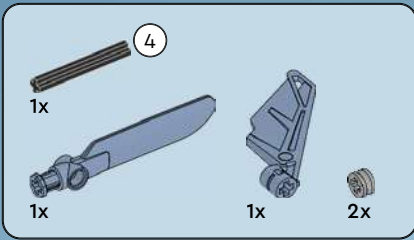

18

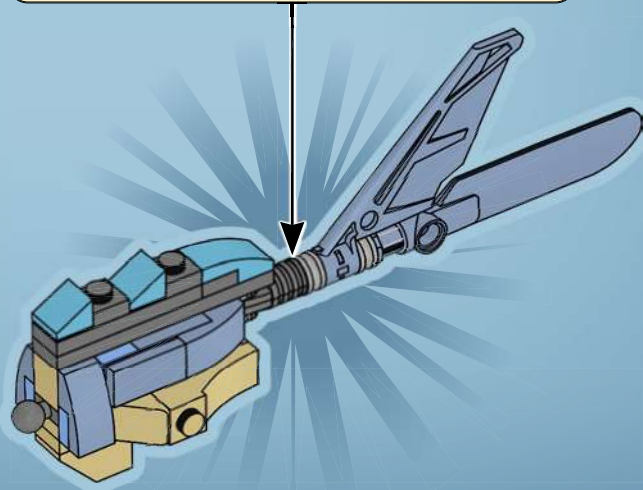
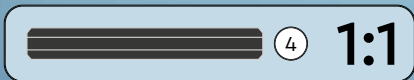
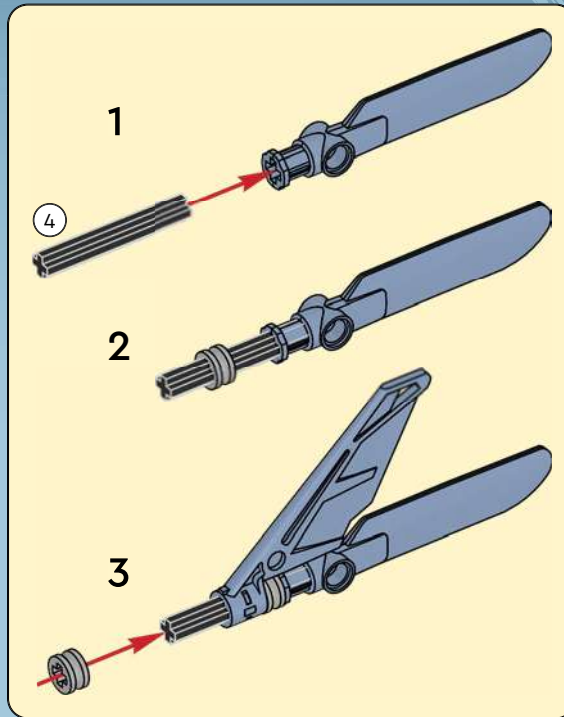





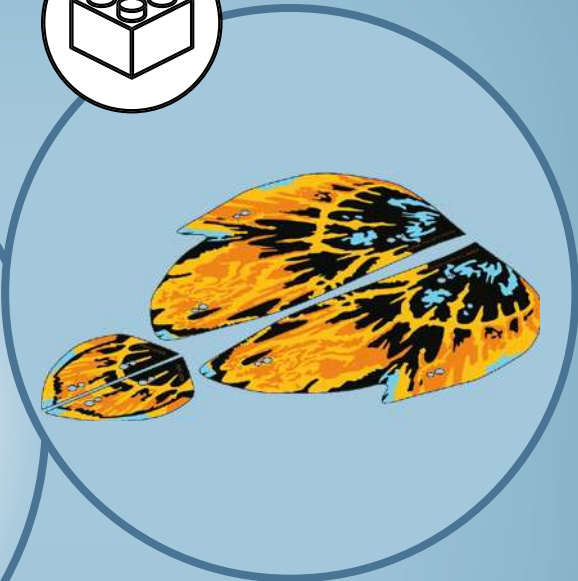
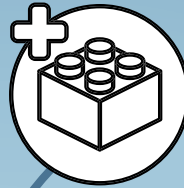

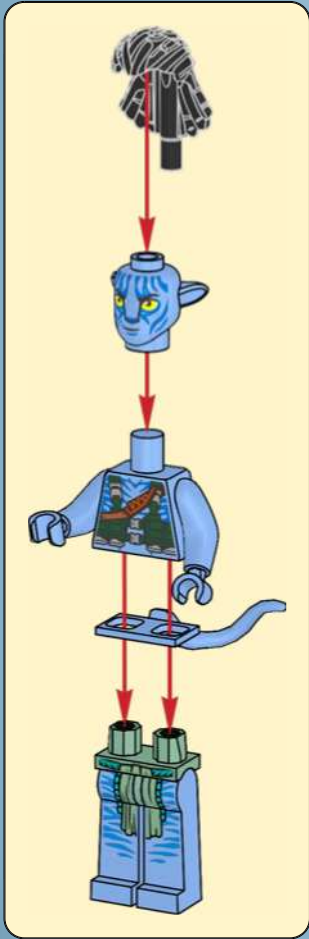



1x



1x

19

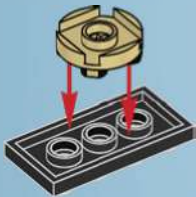

2x

20

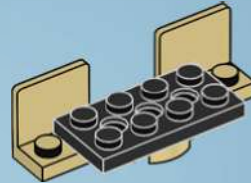

1x

21





1x



1x



1x

22

1



2

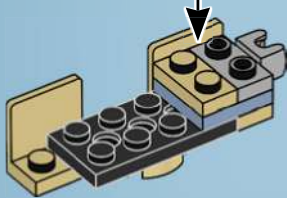
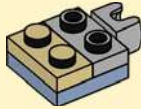

2x



2x

23

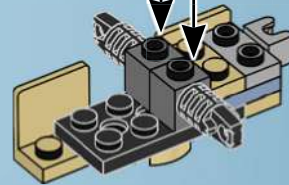



1x

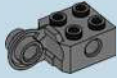

1x

24

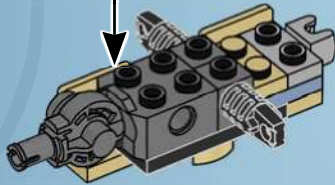
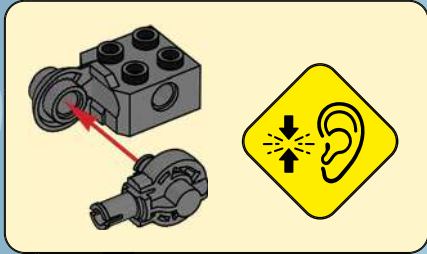

2x

25

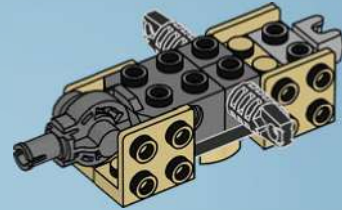

1x

26

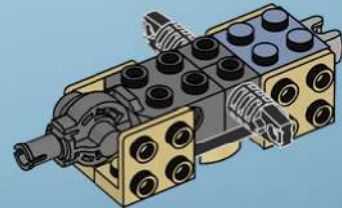



4x



2x

27

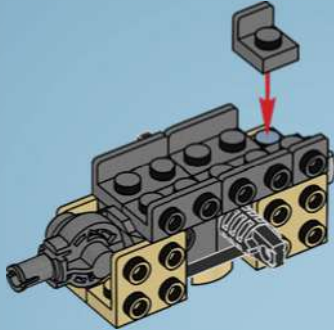

1x



1x

28

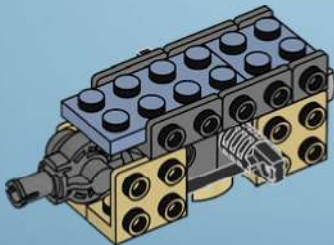

6x

29

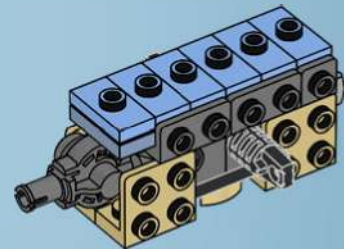



1x



1x

30

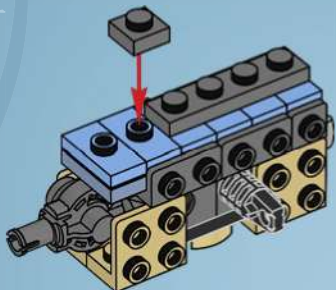

2x



2x



1x

31

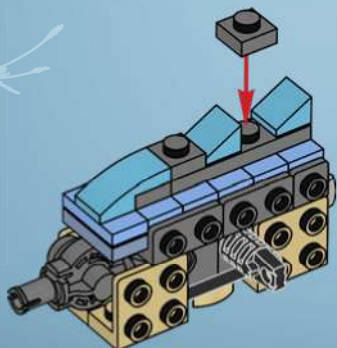

2x



1x

32

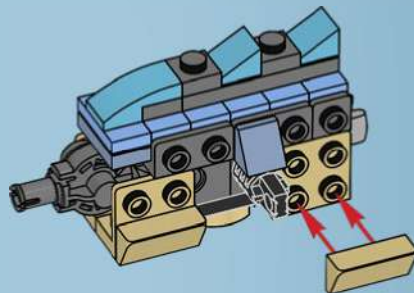

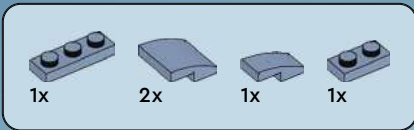

33

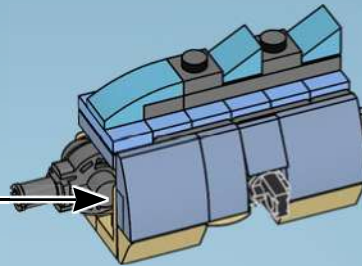
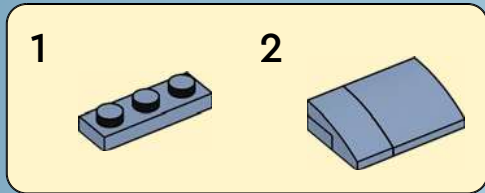
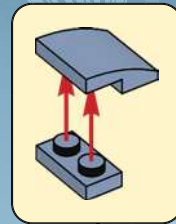

34

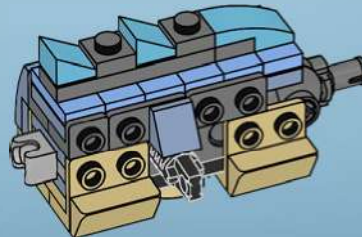

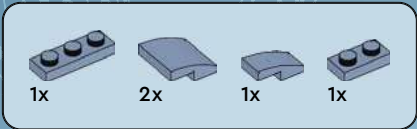

35

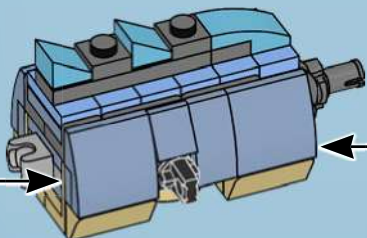
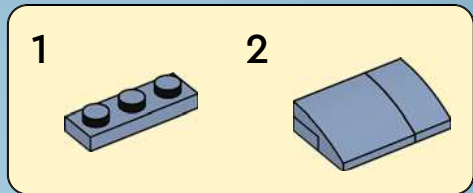
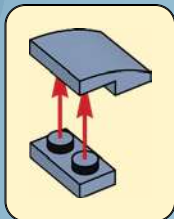

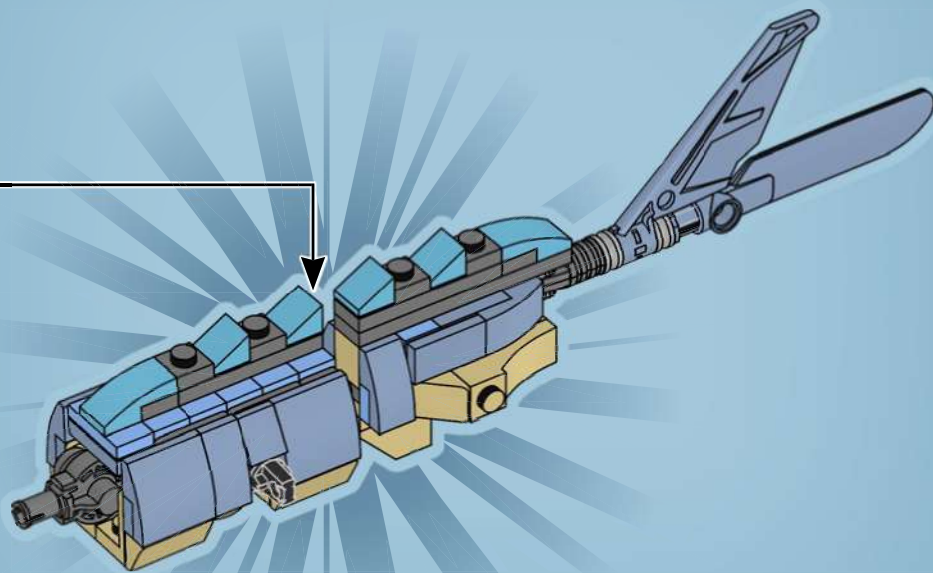

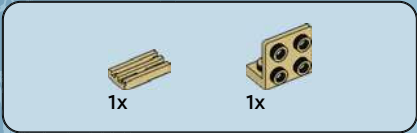
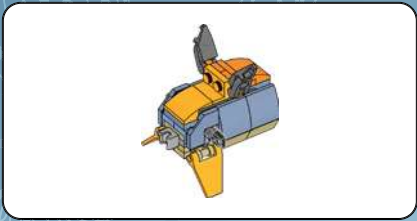

37

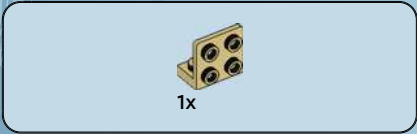

38

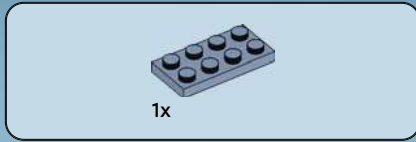

39

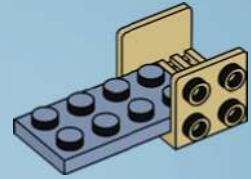

40

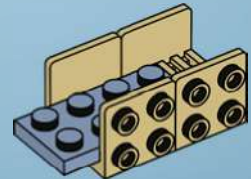



2x

41

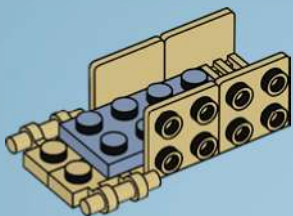

1x



1x

42

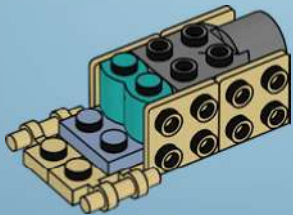

2x



2x

43

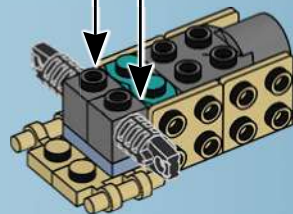
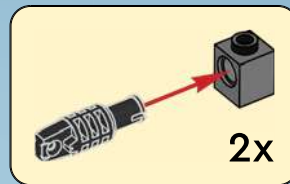



4x

44

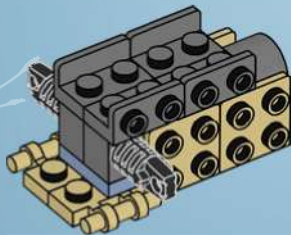

1x



1x

45

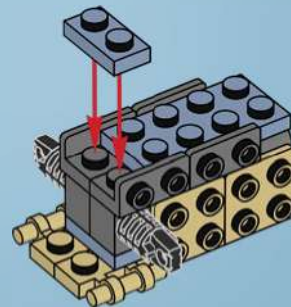



2x



1x



1x



2x

46

1



2

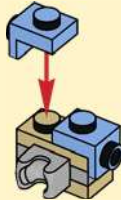

3

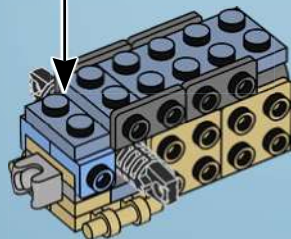

1x

47

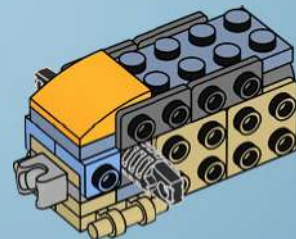



48

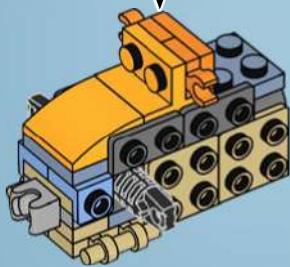

49

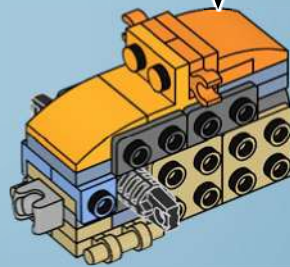
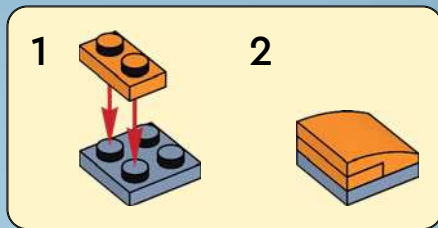



1x

50

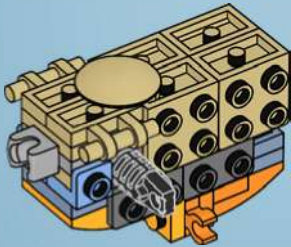

2x



1x

51

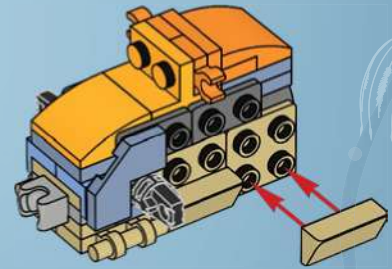
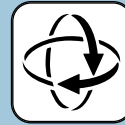



52

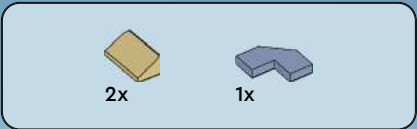
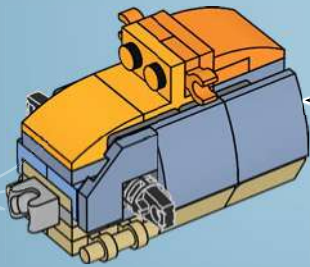
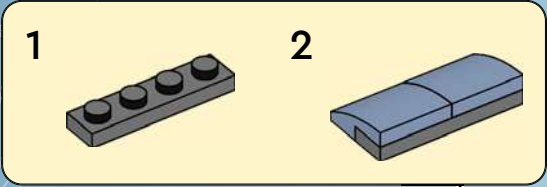

53

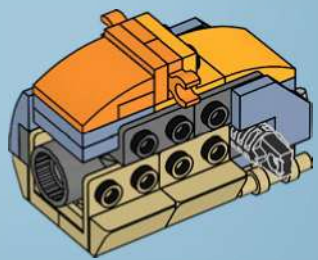

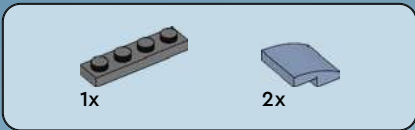

54

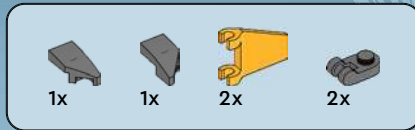
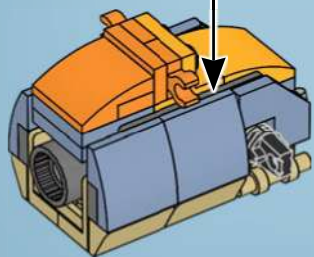
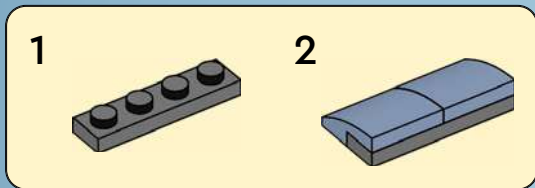

55

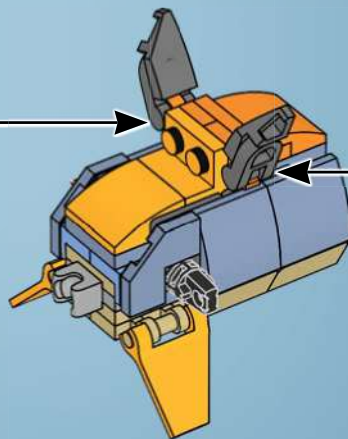
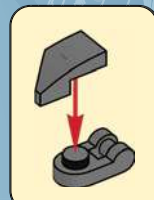

56

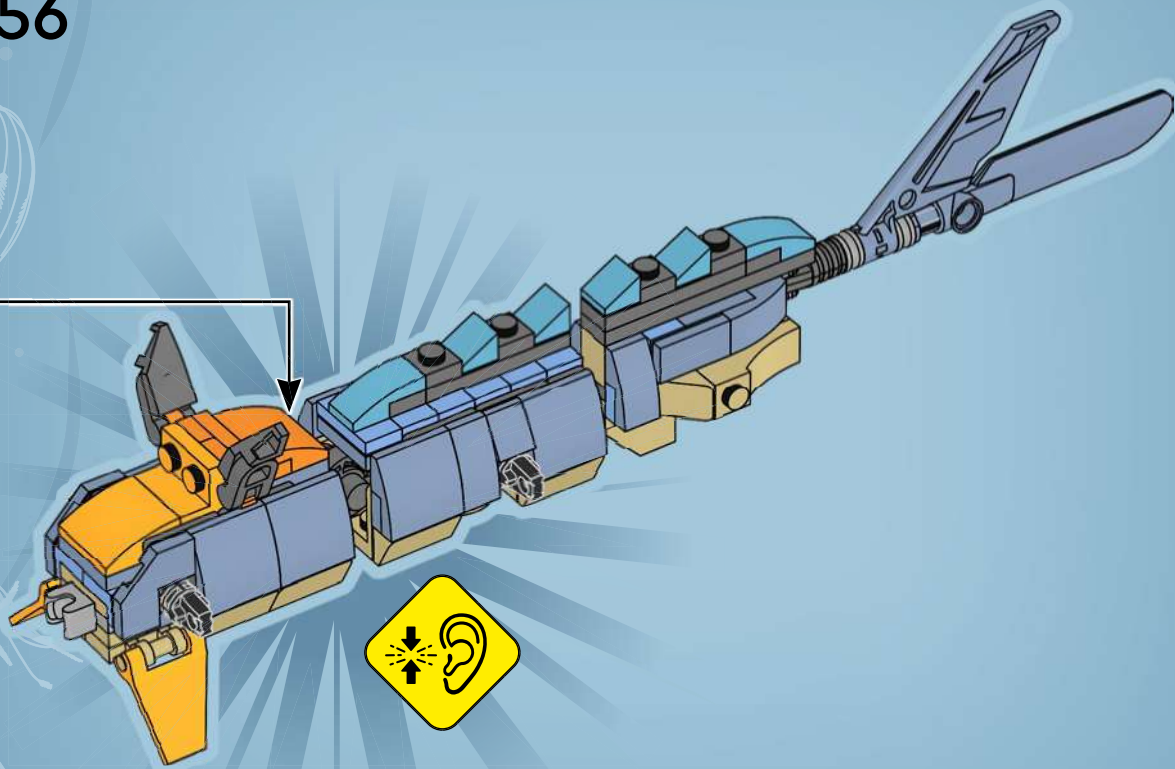

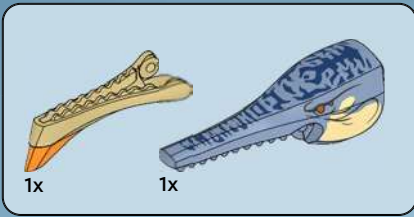

57

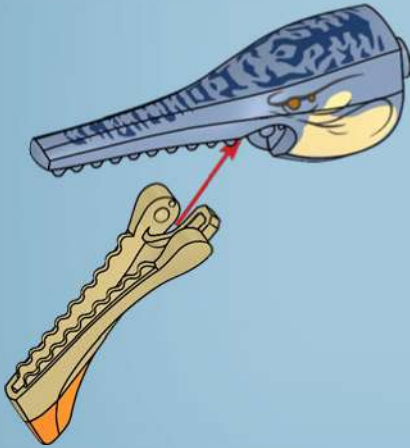

58

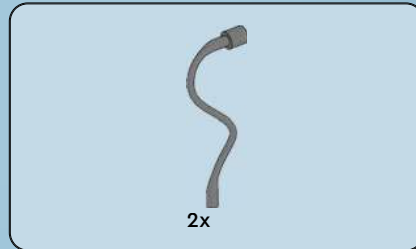
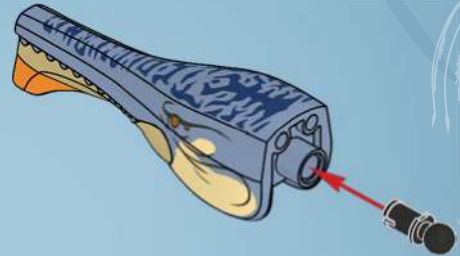

59



60

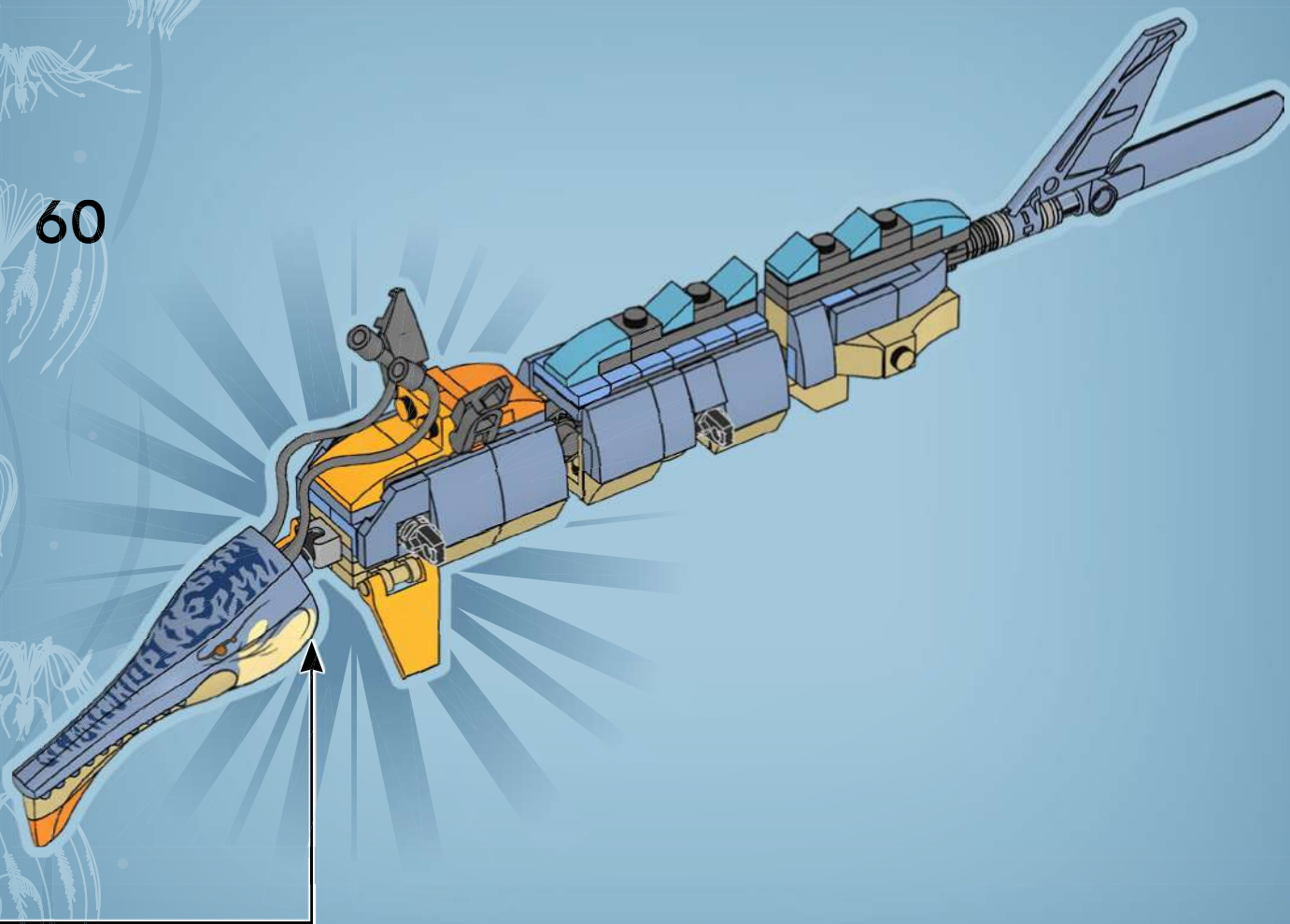

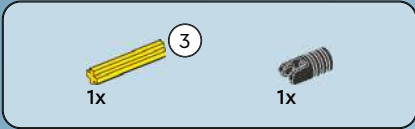
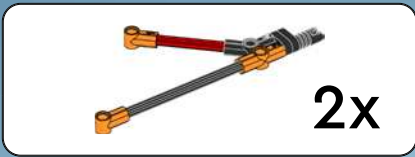

61

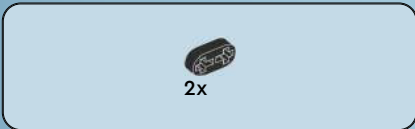
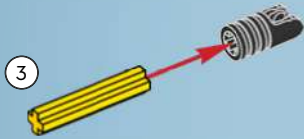

62

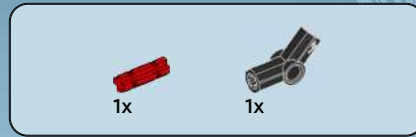

63

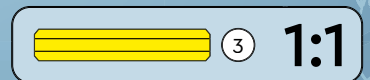
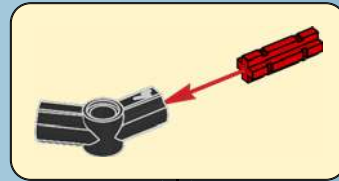



1x

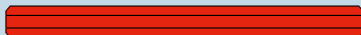

6

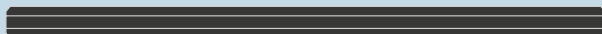

10

1:1

64

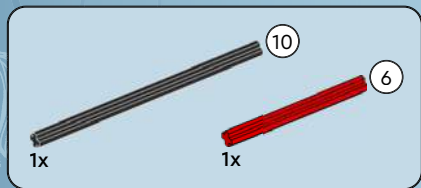

1x

1x

65

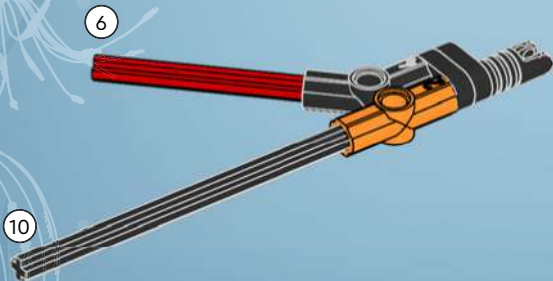

6

10



2x

66



2x

67

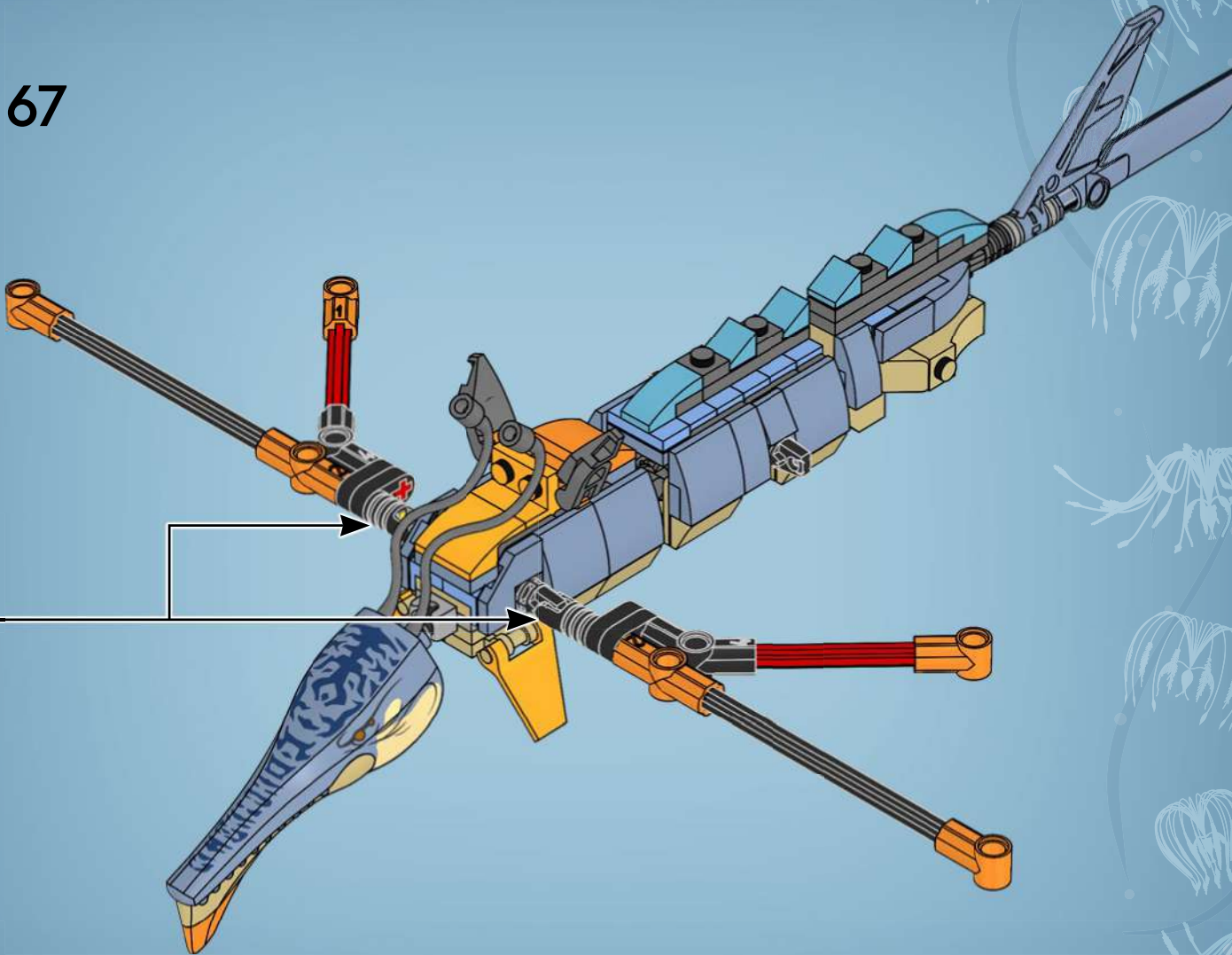



68

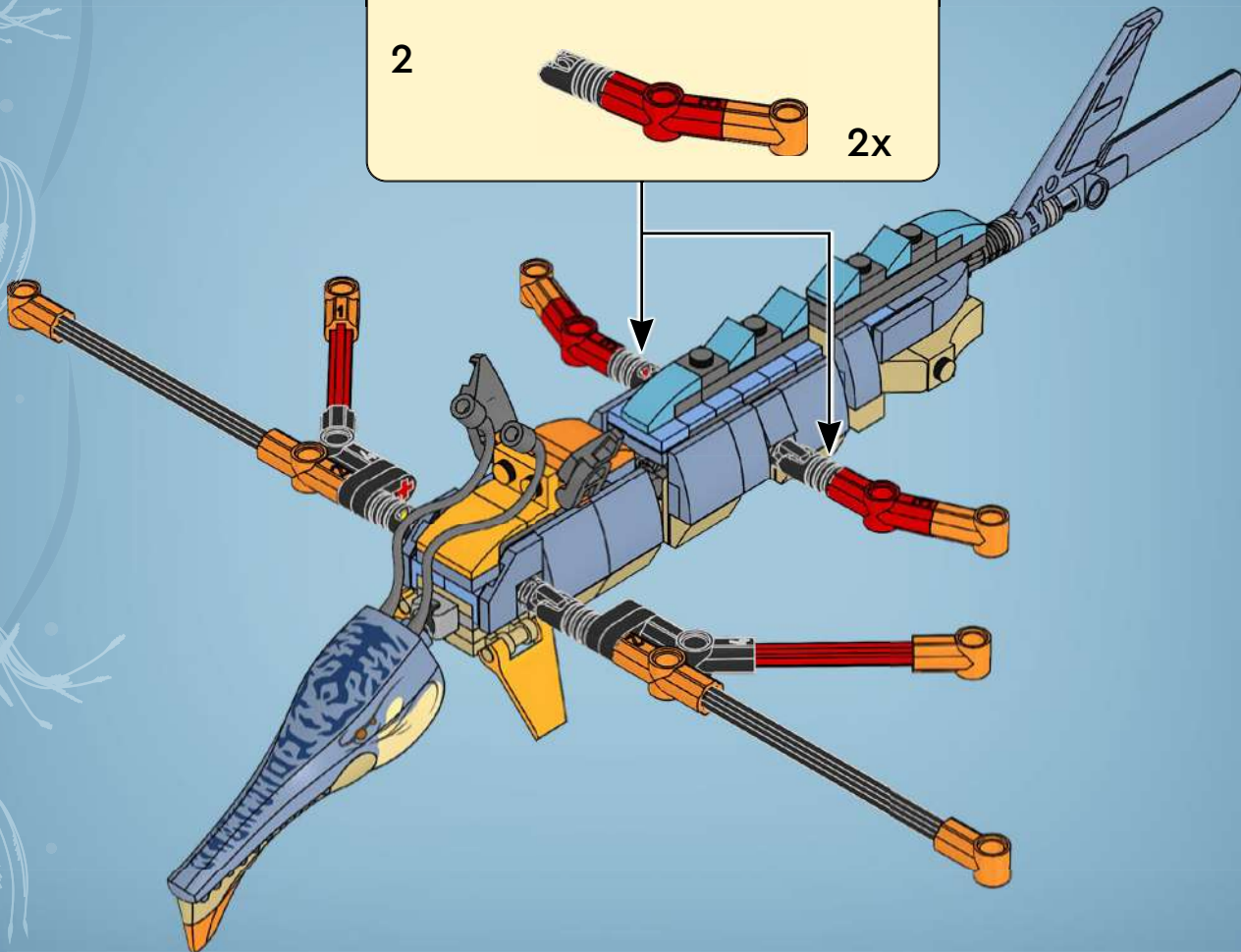
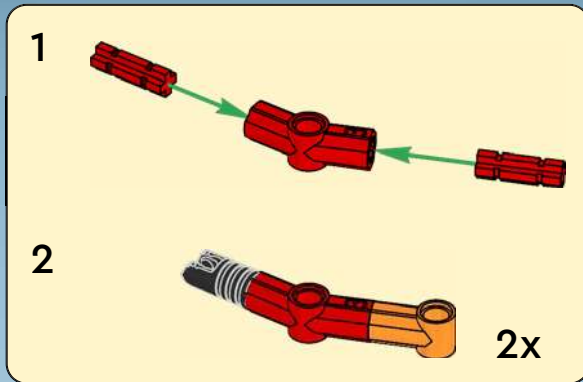



10x

69

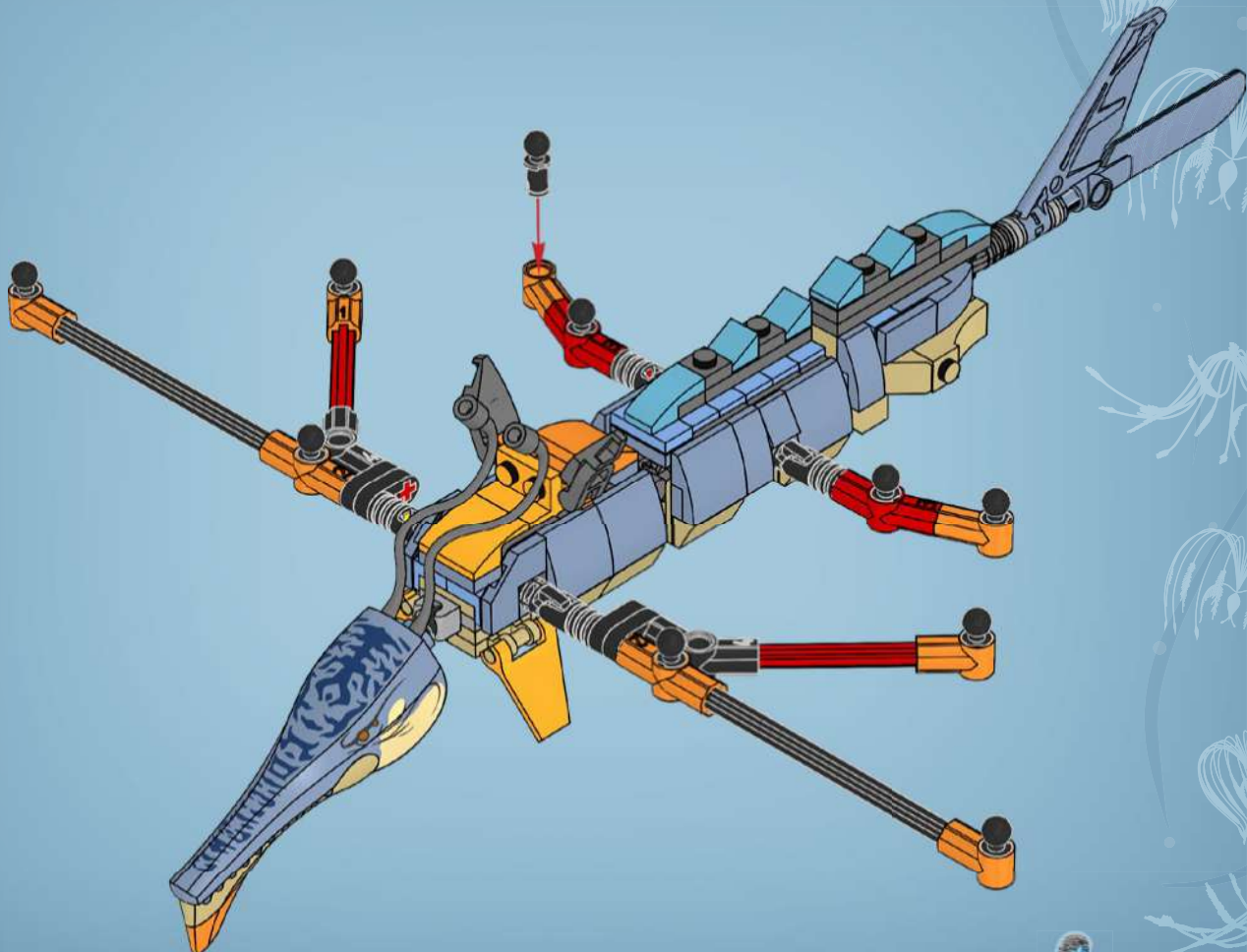

70

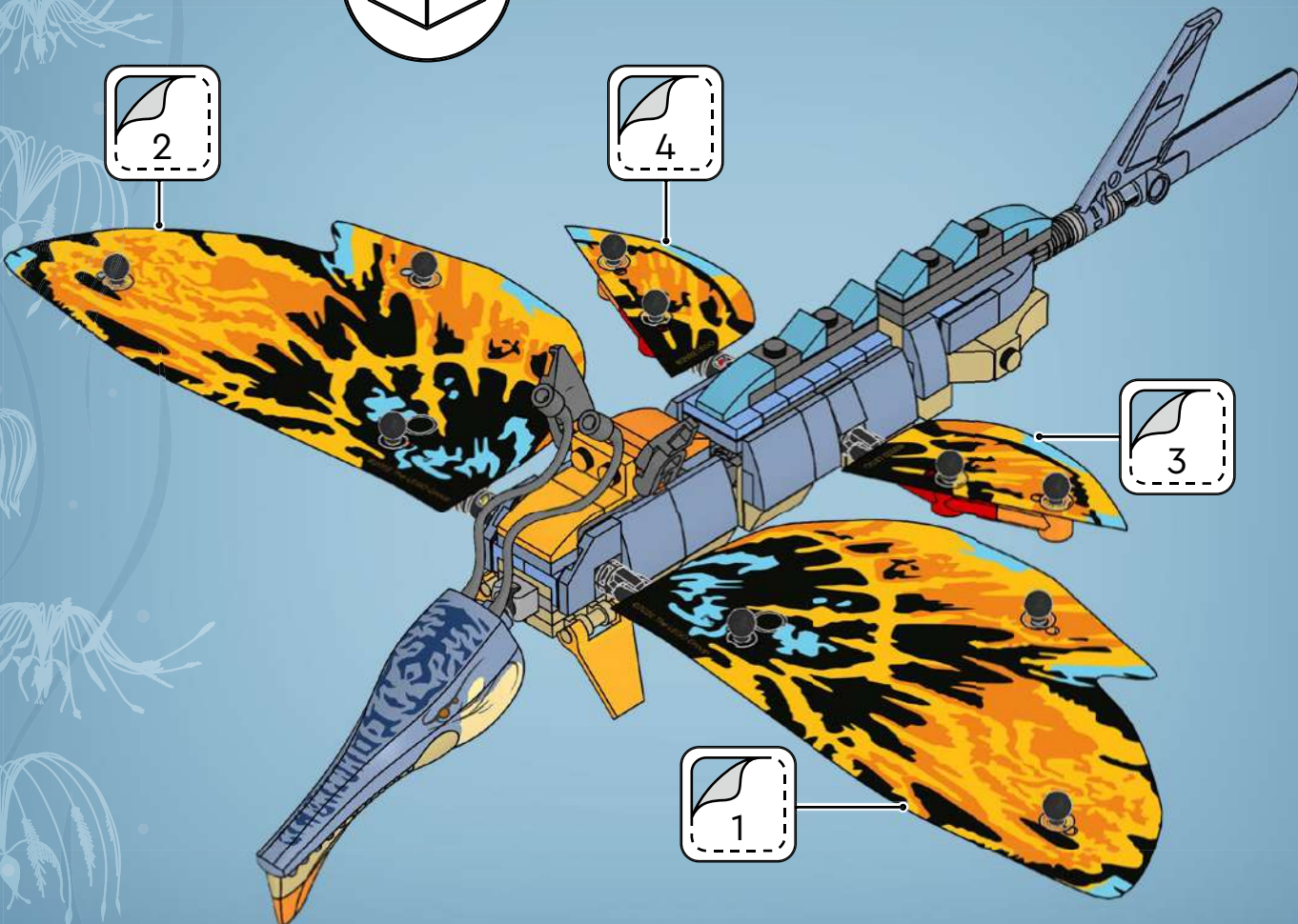
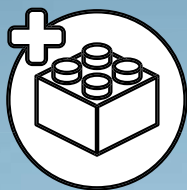





AVATAR



75571



75572



75573



75574





75575



75576



75577



75578



75579



1x
6392165

2x
6365499

1x
6099730

1x
6451069

1x
6428805

1x
6434369

2x
6271165

2x
6043656

1x
6267136

7x
4210639

1x
6204668

6x
4210719

2x
6225494

1x
6265702

2x
6388119

1x
6204667

2x
6425976

2x
6168776

8x
6000606

1x
4522784

1x
6123814

1x
6278974

4x
4211001

1x
6343337

1x
4211056

4x
6421616

2x
6362254

4x
6212501

2x
6430673

2x
6133832

4x
4619520

1x
6421767

1x
6420861

2x
6071246

1x
6430050

6x
6332584

2x
6352223

2x
4177932

1x
6067913



2x
6271874

2x
6134717

3x
6420918

1x
6291414

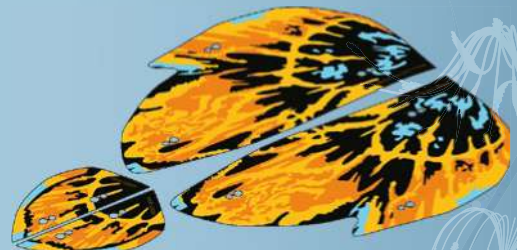
1x
6292823

1x
6424660



 [LEGO.com/service](https://www.LEGO.com/service)

YOU COULD

WIN



Scan this QR code or go to
LEGO.COM/PRODUCTFEEDBACK and give us
your short feedback about this LEGO® set for a
chance to win a cool LEGO prize.

Terms and Conditions apply*

DE: Du könntest GEWINNEN. Es gelten die Teilnahmebedingungen* **FR: Tu pourrais GAGNER.** Des conditions s'appliquent* **IT: Potresti VINCERE tu.** Termini e condizioni sono applicabili* **ES: Puedes GANAR.** Aplican términos y condiciones* **PT: Poderá GANHAR.** Aplicam-se termos e condições* **JA: プレゼント付き! 利用規約が適用されます*** **ZH: 轻松获奖. 条款和条件适用*** **KO: 상품의 주인이 되어보세요. 소정의 약관이 적용됩니다*** **RU: Вы можете ВЫИГРАТЬ.** Действуют положения и условия* **PL: Szansa na WYGRANĄ.** Obowiązują warunki korzystania* **CS: Máte šanci VYHRÁT.** Platí všeobecné smluvní podmínky* **SK: Máte šancu VYHRAŤ.** Platia všeobecné zmluvné podmienky* **HU: TE IS NYERHETSZ.** Felhasználási feltételek érvényesek* **RO: Ai putea CÂȘTIGA.** Se aplică termeni și condiții* **BG: Можете да СПЕЧЕЛИТЕ.** Има определени правила и условия* **LV: Tu vari LAIMĒT.** Ir spēkā noteikumi un nosacījumi.* **ET: Sul on võimalus VÕITA.** Kehtivad tingimused* **LT: Jūs galite LAIMĖTI.** Taikomos sąlygos*

*LEGO.com/productfeedback-terms

LEGO and the LEGO logo are trademarks of the LEGO Group. ©2023 The LEGO Group.

TM & © 20th Century Studios

6491757