



CITY

60388





LEGO.com/sustainable-packaging



BUILDER



Apple and the Apple logo are trademarks of Apple Inc., registered in the U.S. and other countries and regions. App Store is a service mark of Apple Inc. Google Play and the Google Play logo are trademarks of Google LLC. Tencent and the Tencent logo are trademarks of Tencent Inc.

LEGO.com/devicecheck

EN Ask parents' permission before going online | DE Eltern um Erlaubnis bitten, bevor du online gehst | FR Demande l'autorisation d'un parent avant d'aller en ligne | IT Chiedi il permesso ai tuoi genitori prima di andare online | ES Pídeles permiso a tus papás antes de conectarte a Internet | PT Peça autorização aos pais antes de acederes online | JA オンラインになる前にほご者の方のきよかをもらおう | ZH 上网前应先征得父母的同意 | KO 온라인 접속 전에 보호자 동의가 필요합니다 | RU Спроси разрешения у родителей, прежде чем заходить в интернет | PL Poproś rodziców o zgodę, zanim wejdiesz do Internetu | CS Než půjdeš na internet, požádej rodiče o svolení | SK Než pôjdeš na internet, vypýtaj si povolenie od rodičov | HU Kérj szülői engedélyt, mielőtt online csatlakoznál! | RO Cere permisiunea părinților înainte de a te conecta online | BG Поискайте разрешение от родител, преди да влезете онлайн | LV Pirms došanās tiešsaistē palūdz atļauju vecākiem | ET Enne Interneti kasutamist küsi vanematelt luba | LT Prieš prisijungdami prie interneto, atsilkauskite tėvų

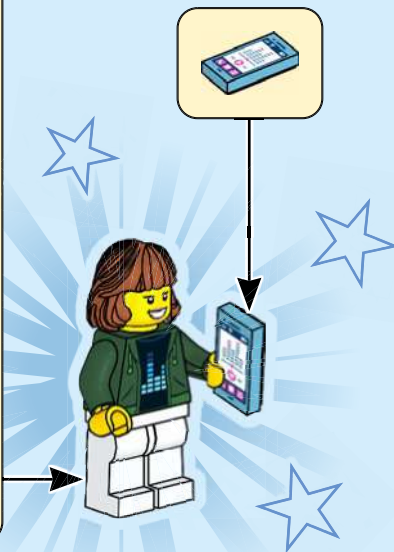
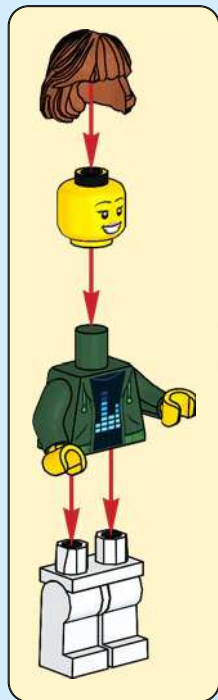

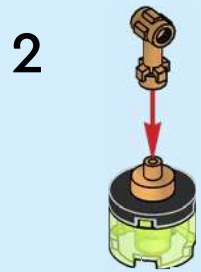
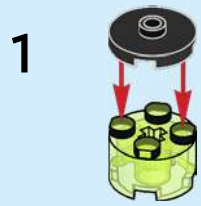

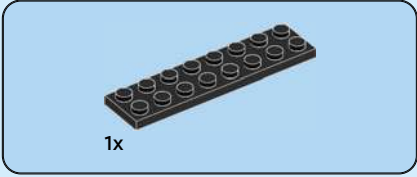

1

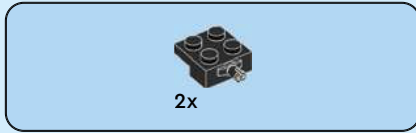

2

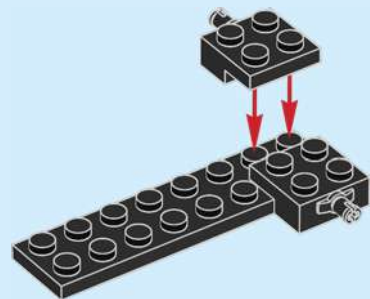

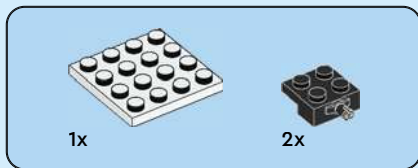

3

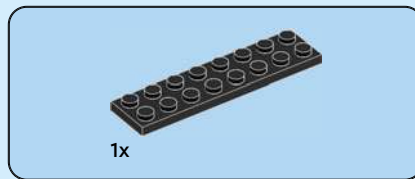
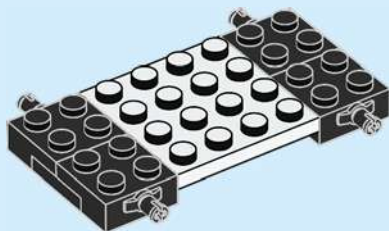

4

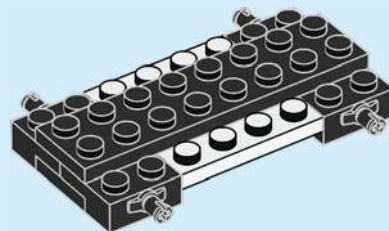

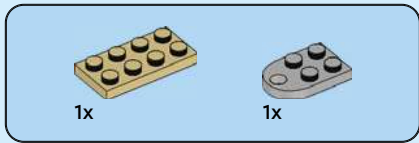

5

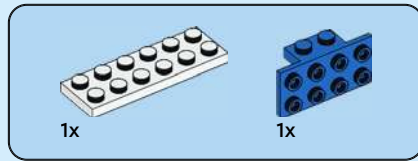
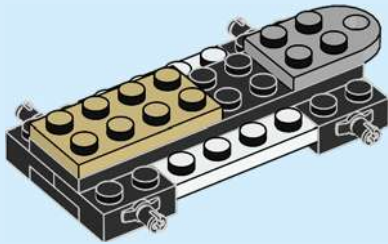

6

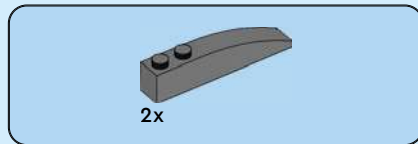
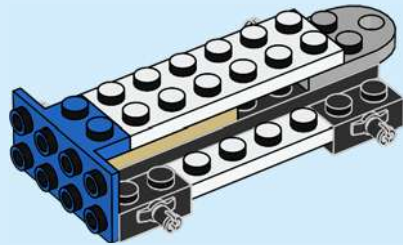

7

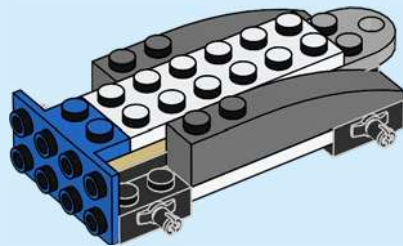

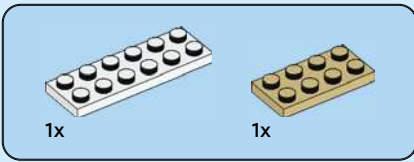

8

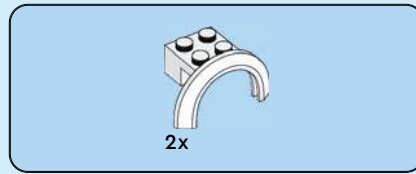
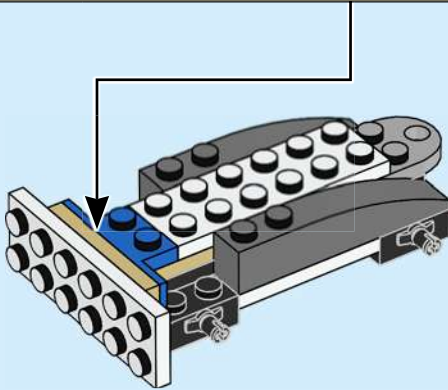
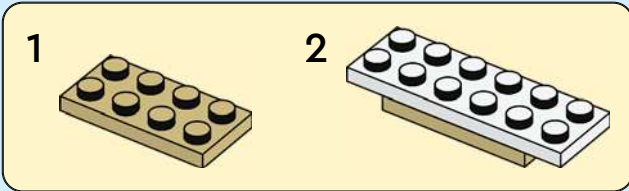

9

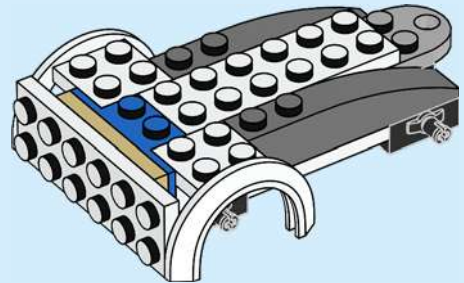

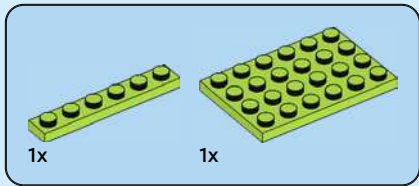

10

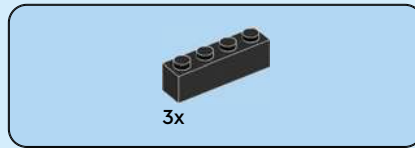
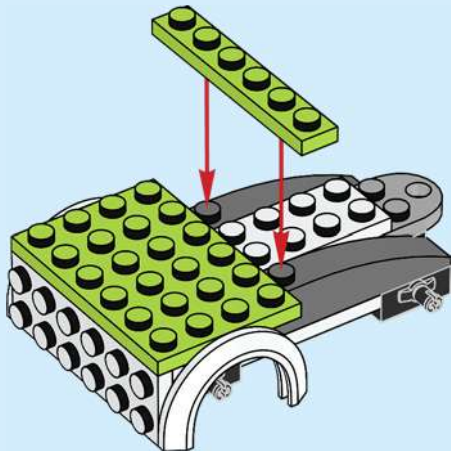

11

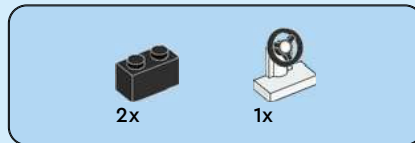
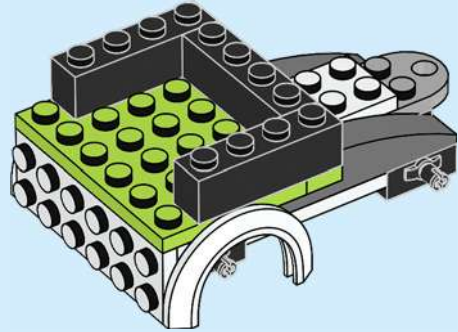

12

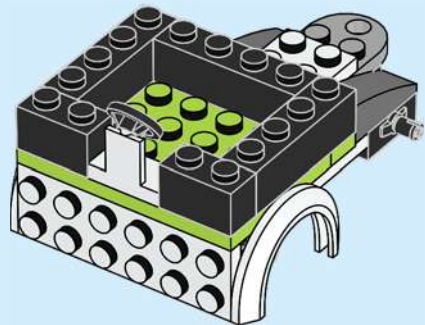

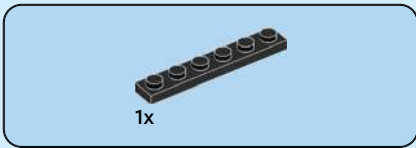

13

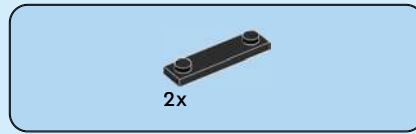
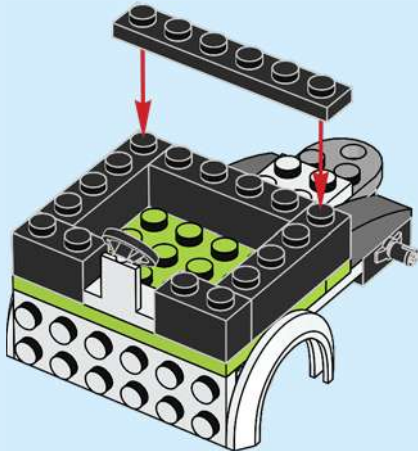

14

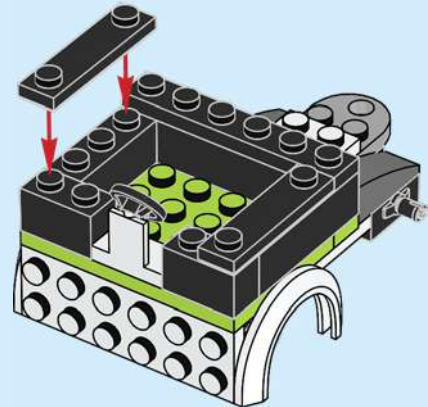

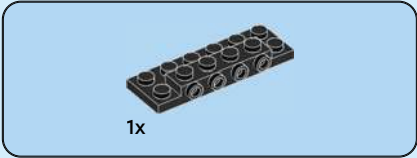

15



16

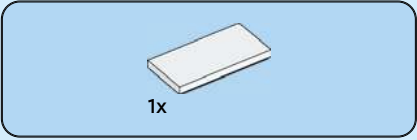
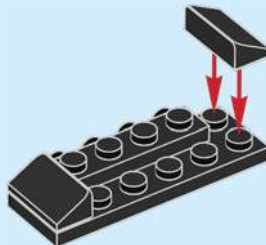

17



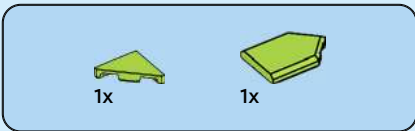

18

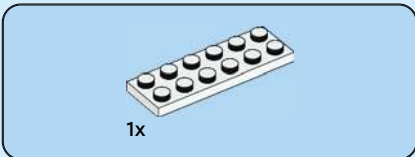

19

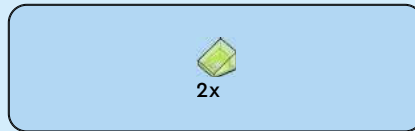

20



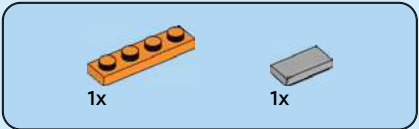

21

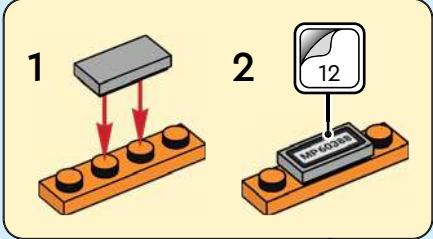

22

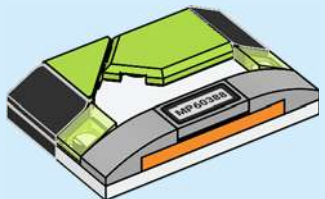

23

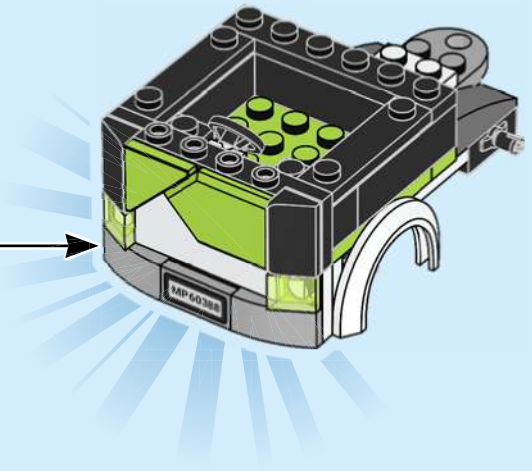

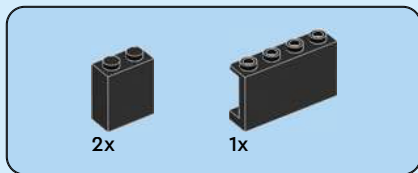

24

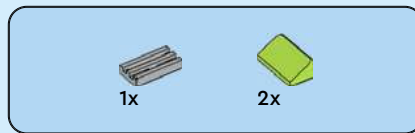
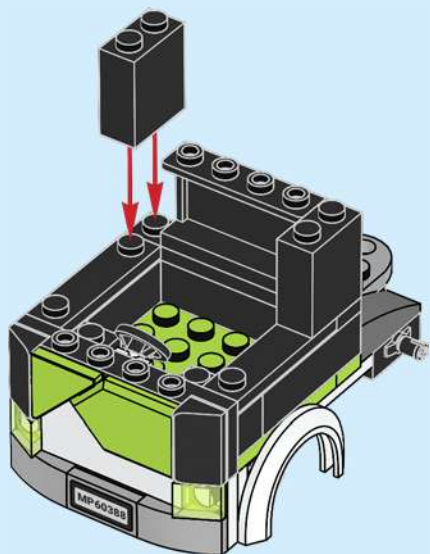

25

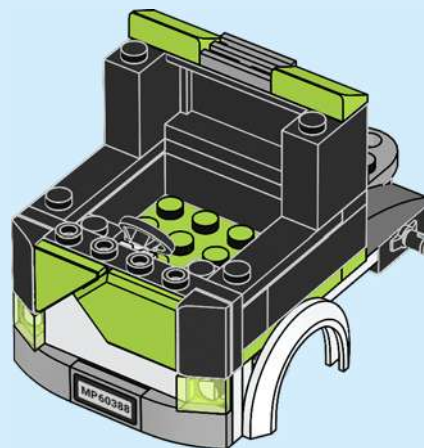



26

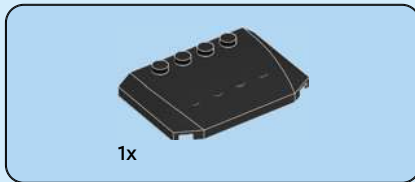
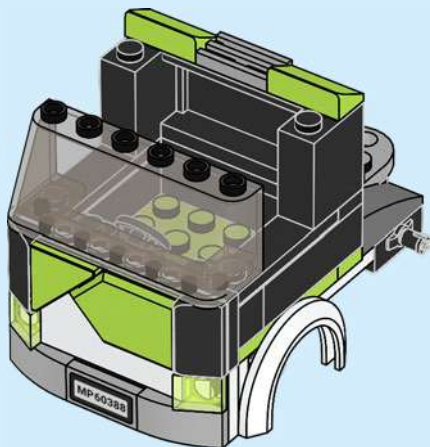

27



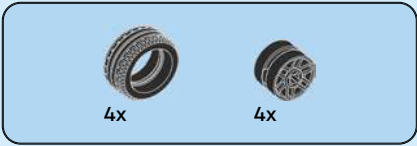

28

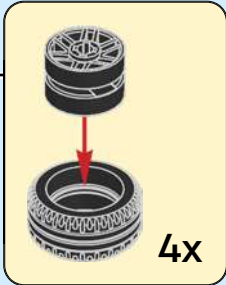
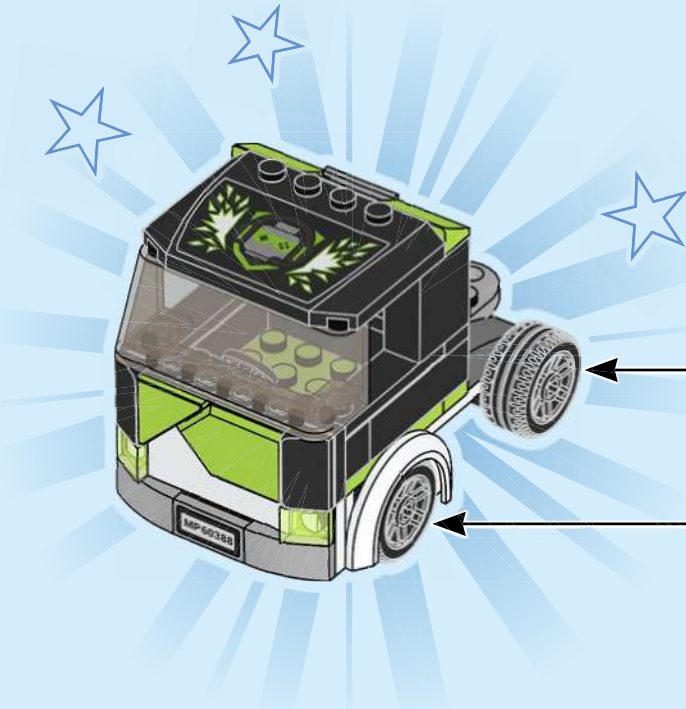

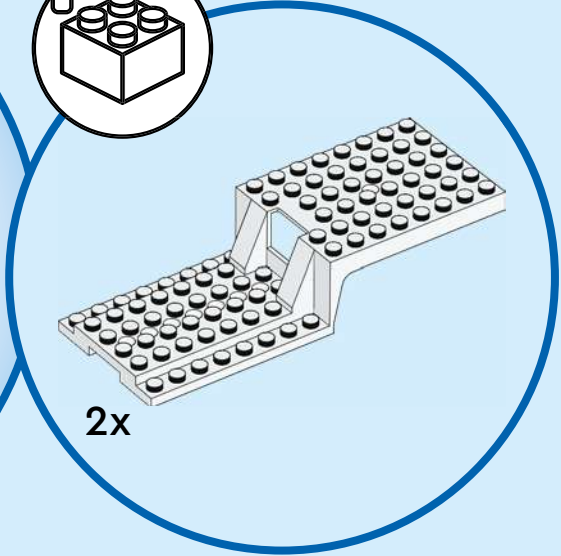
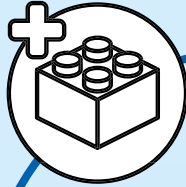

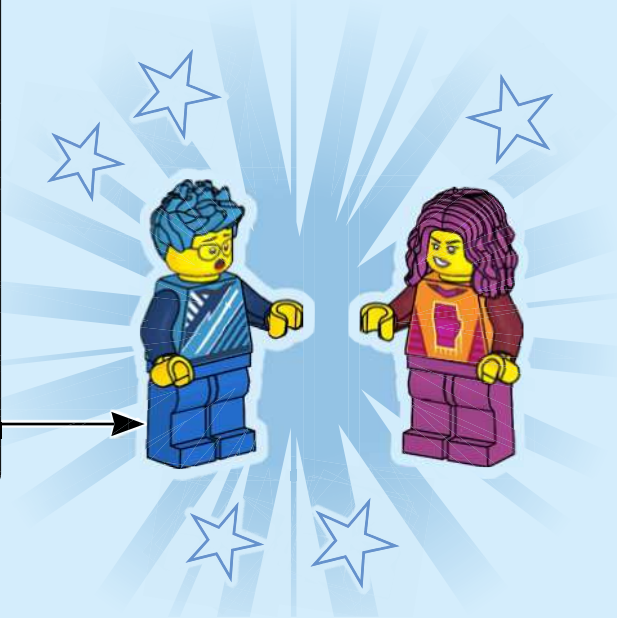
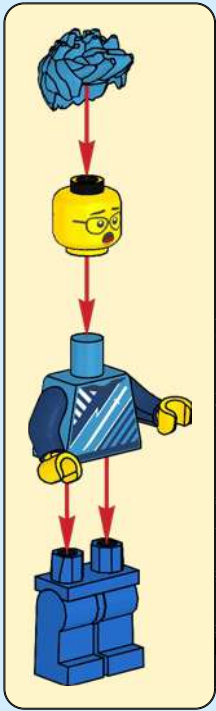

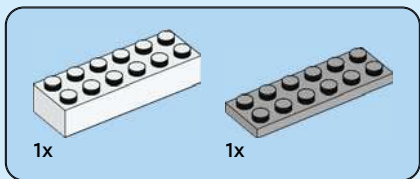
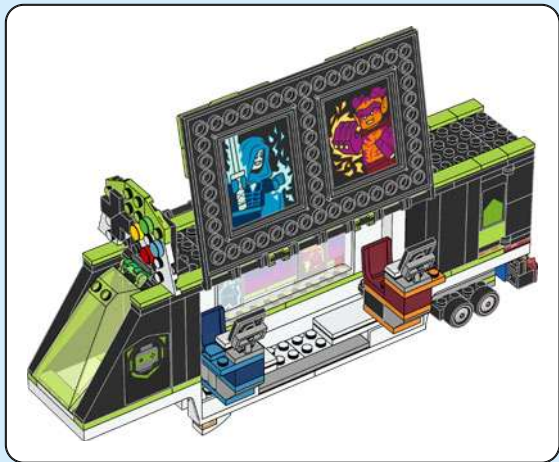

29

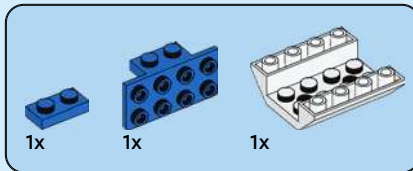
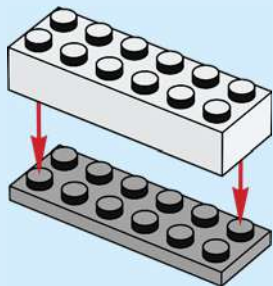

30

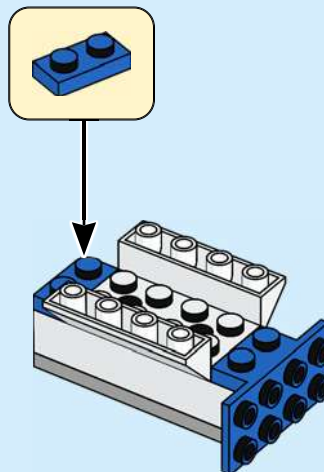

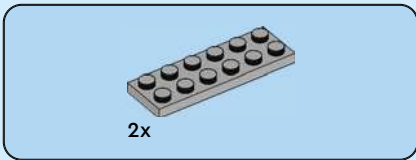

31

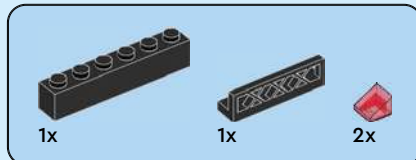
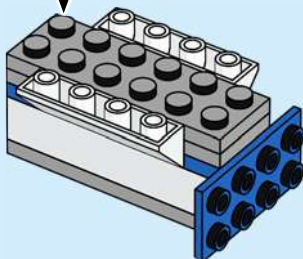
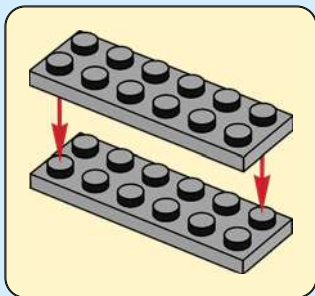

32

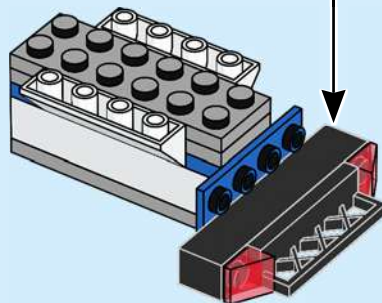
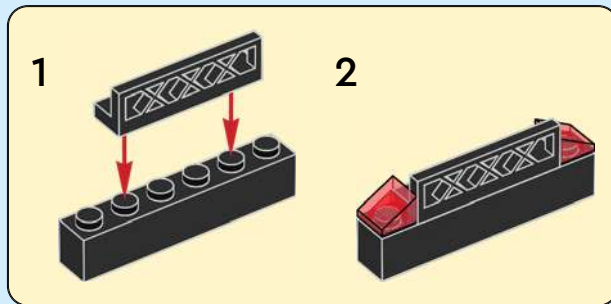

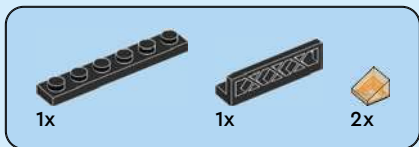

33

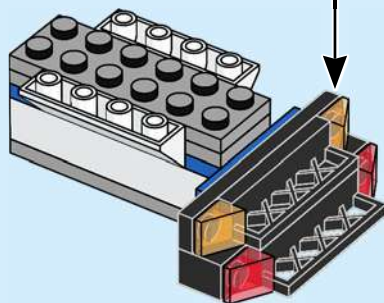
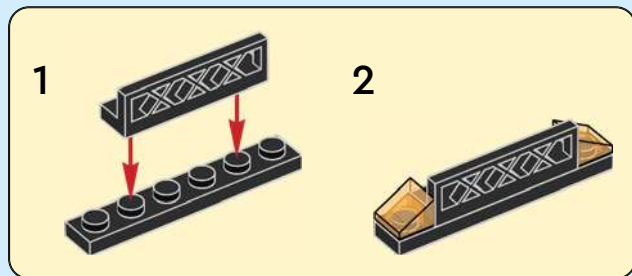

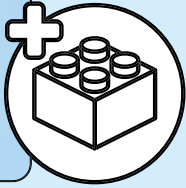
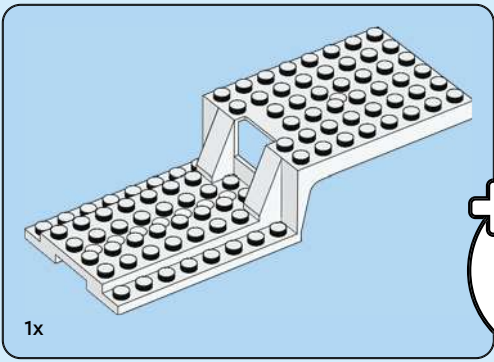

34

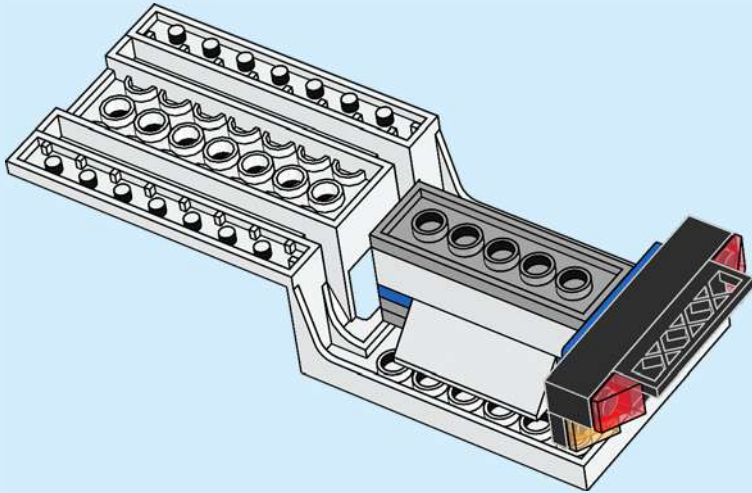

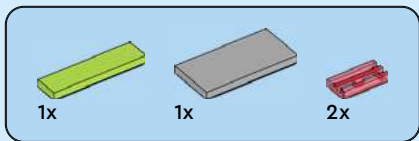

35

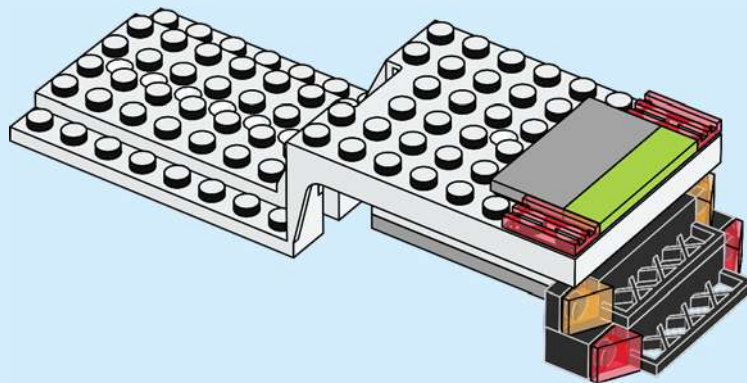

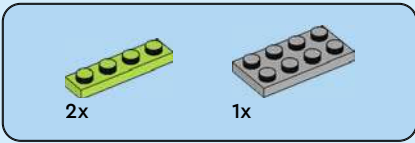

36

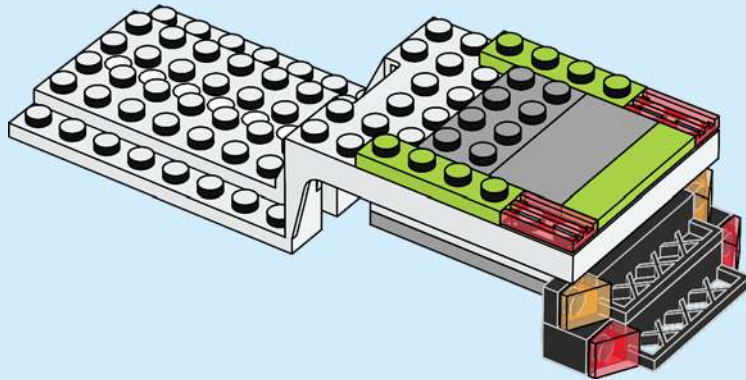

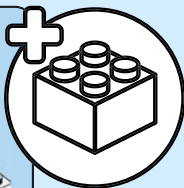
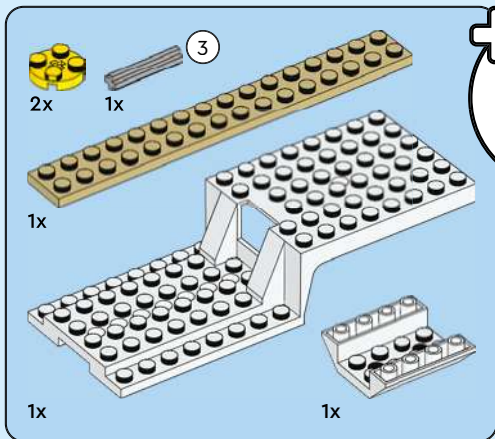

37

1

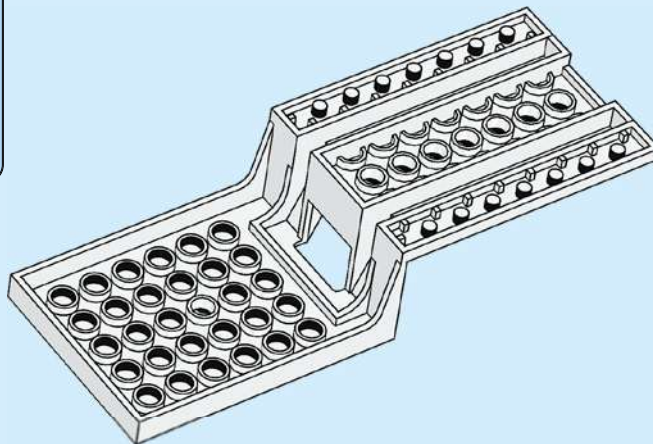

2

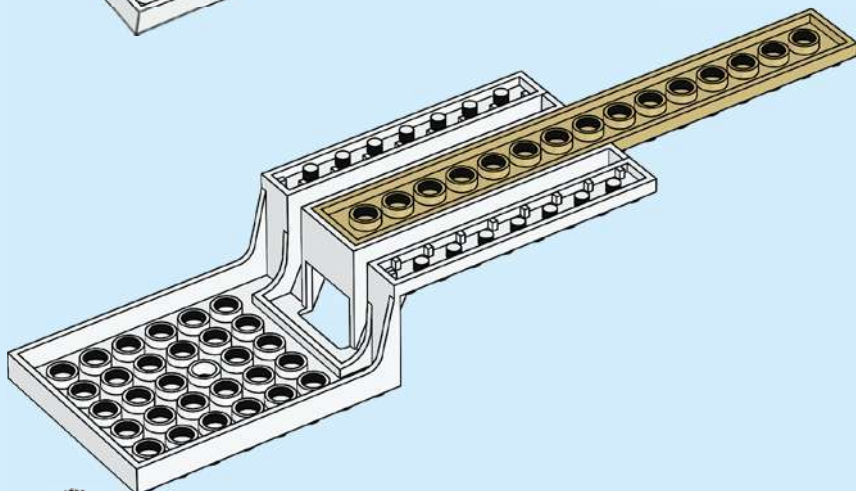

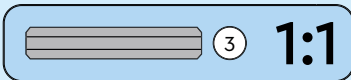
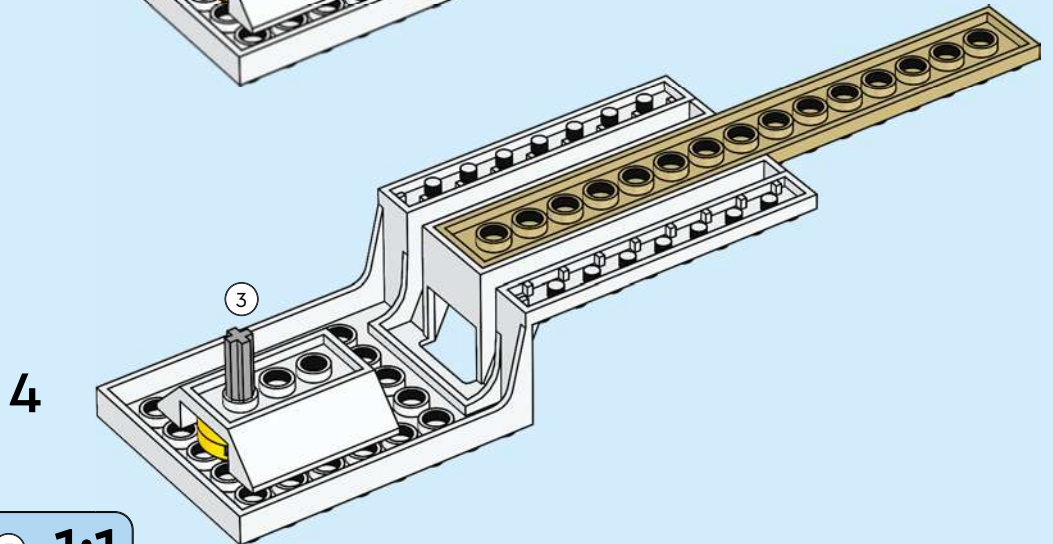
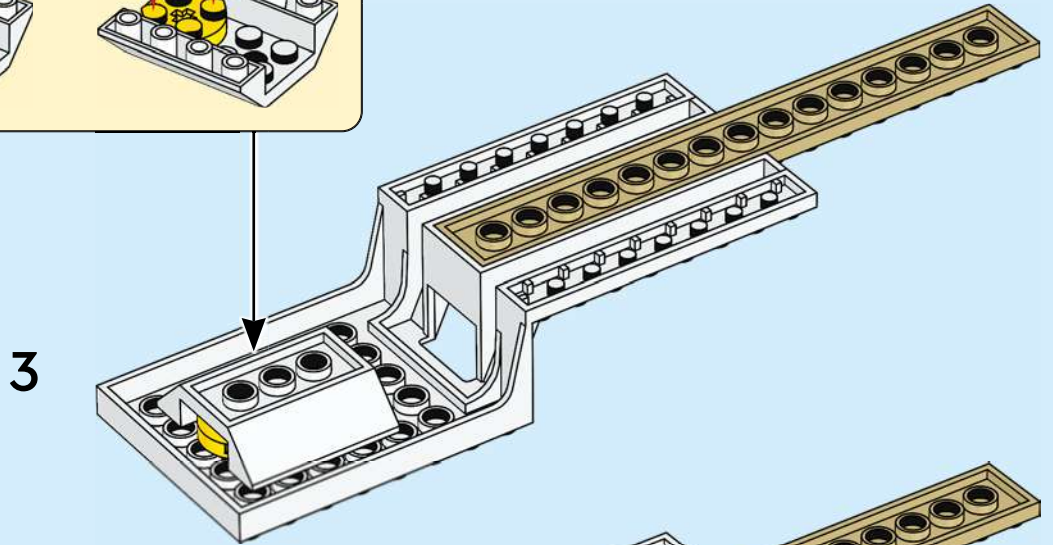
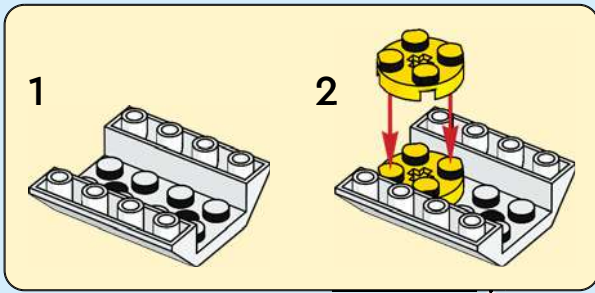

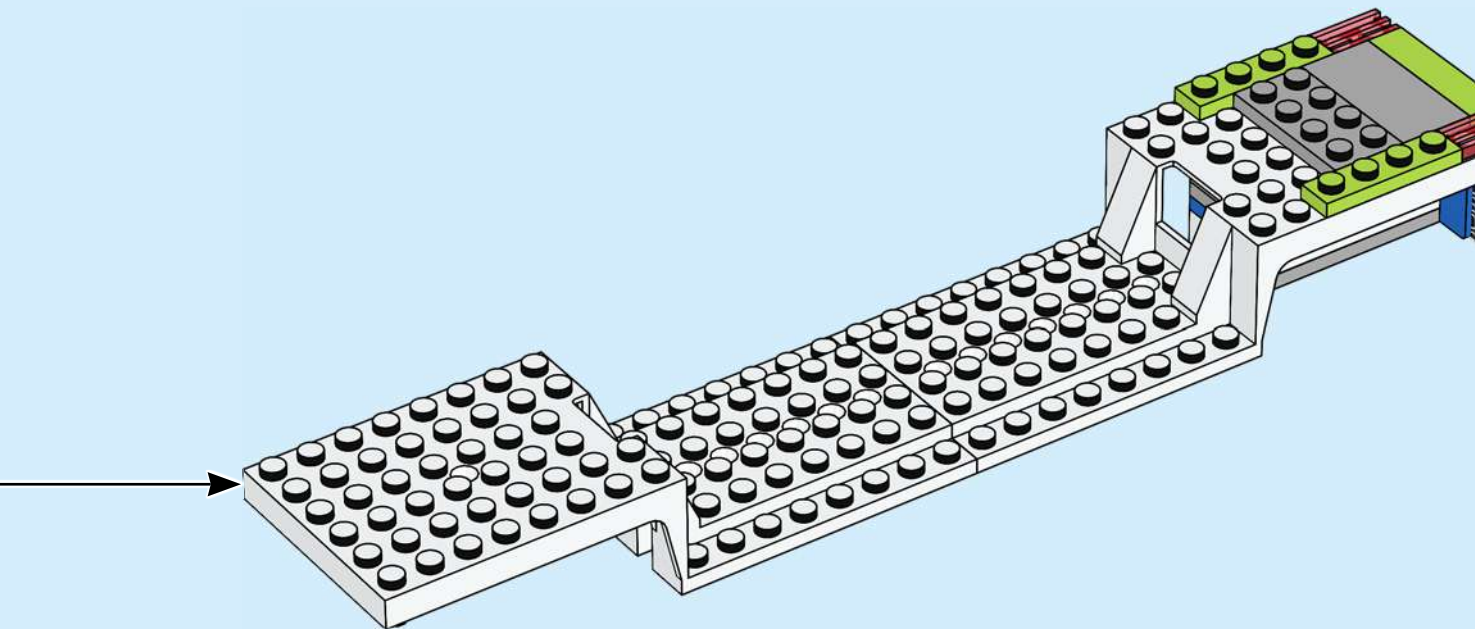

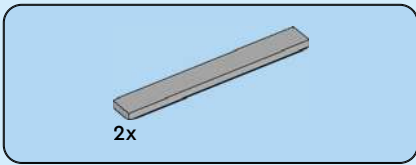

38

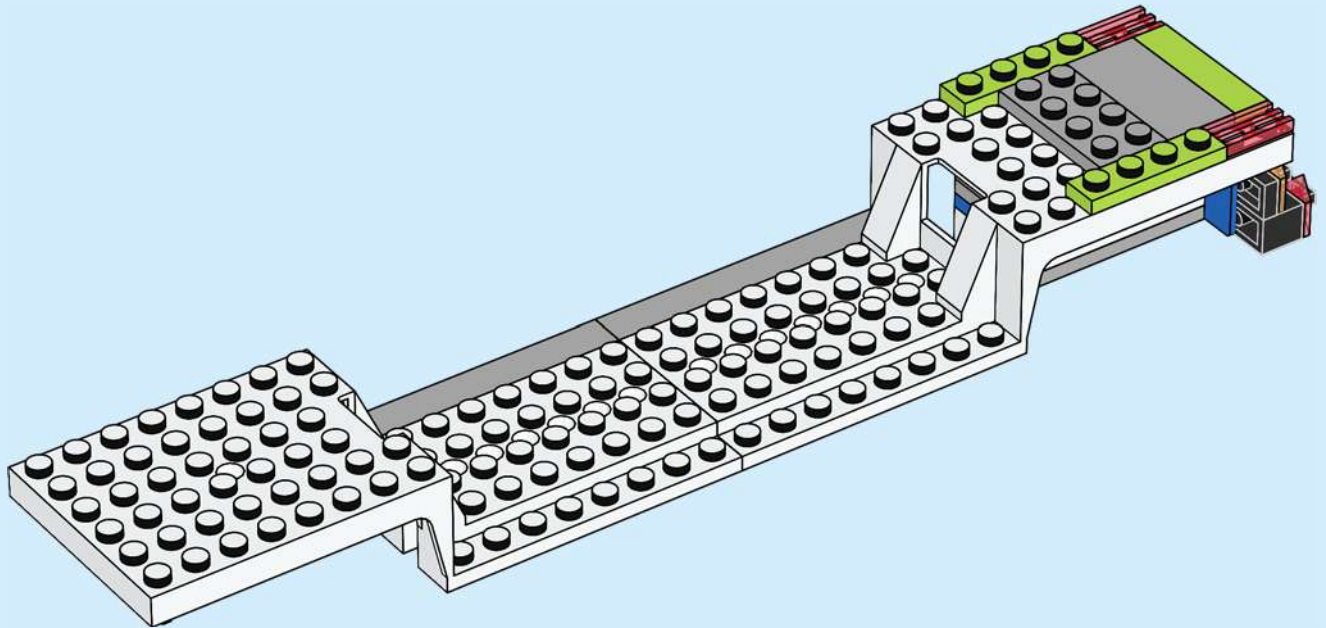



1x

39

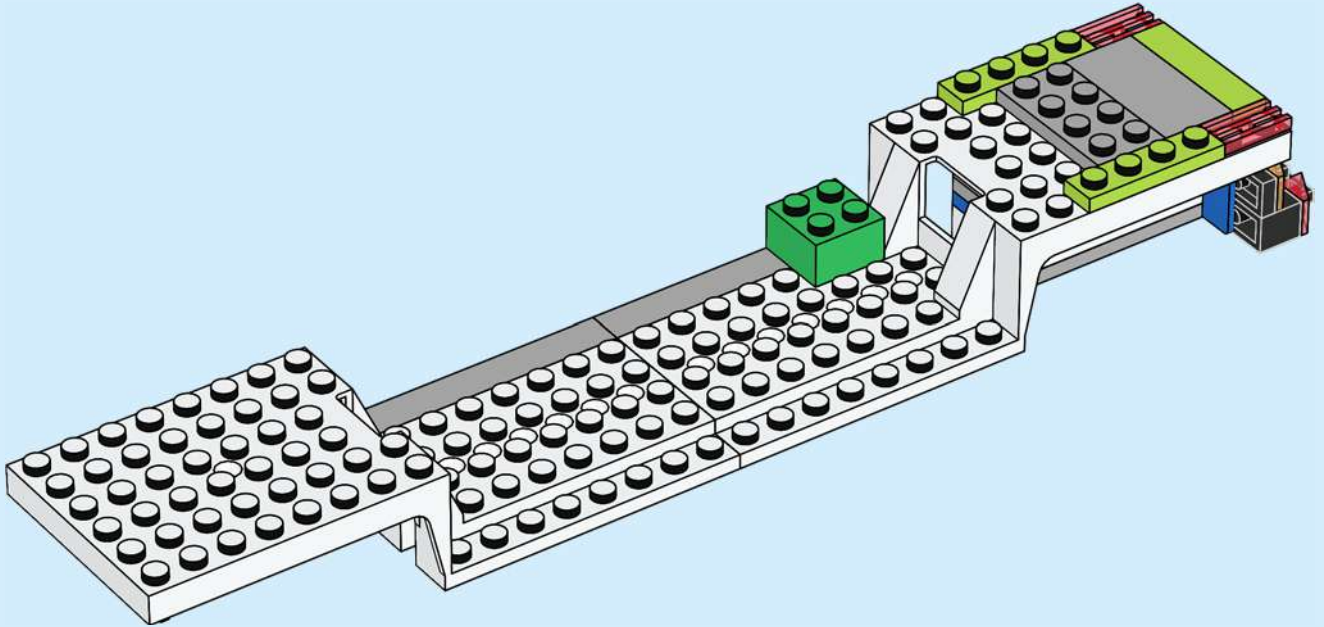

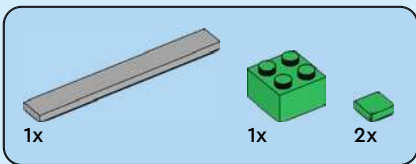

40

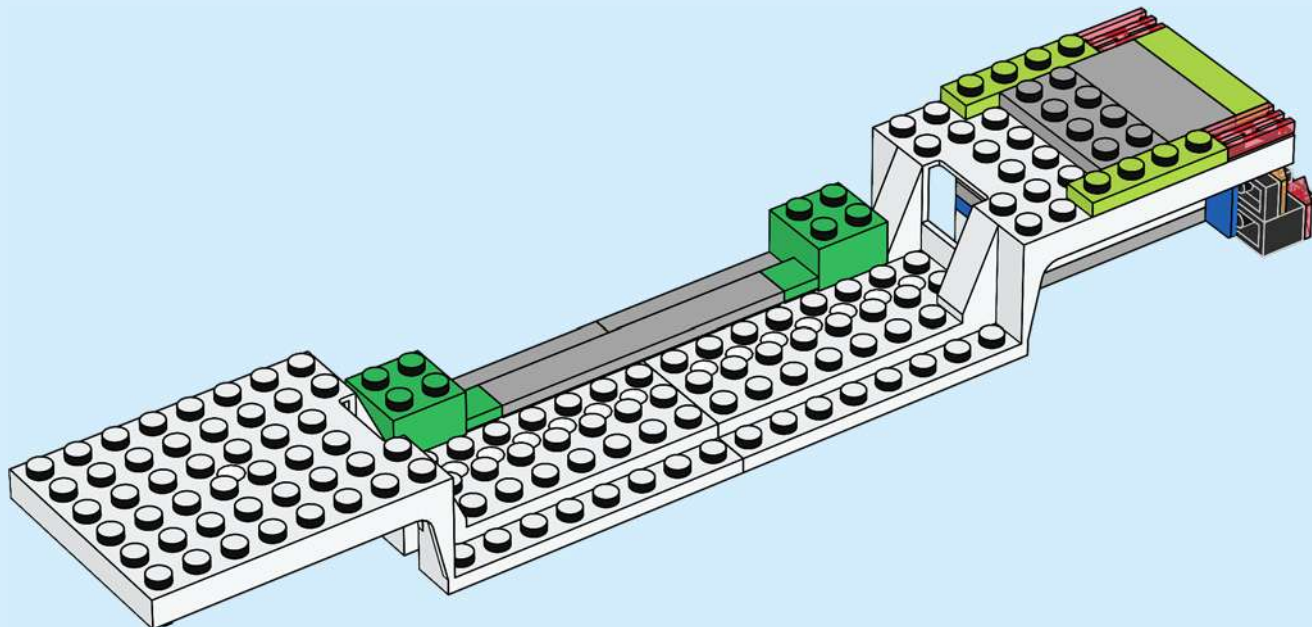

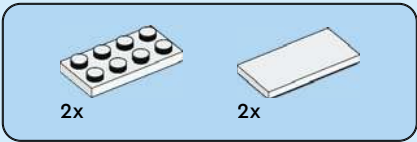

42

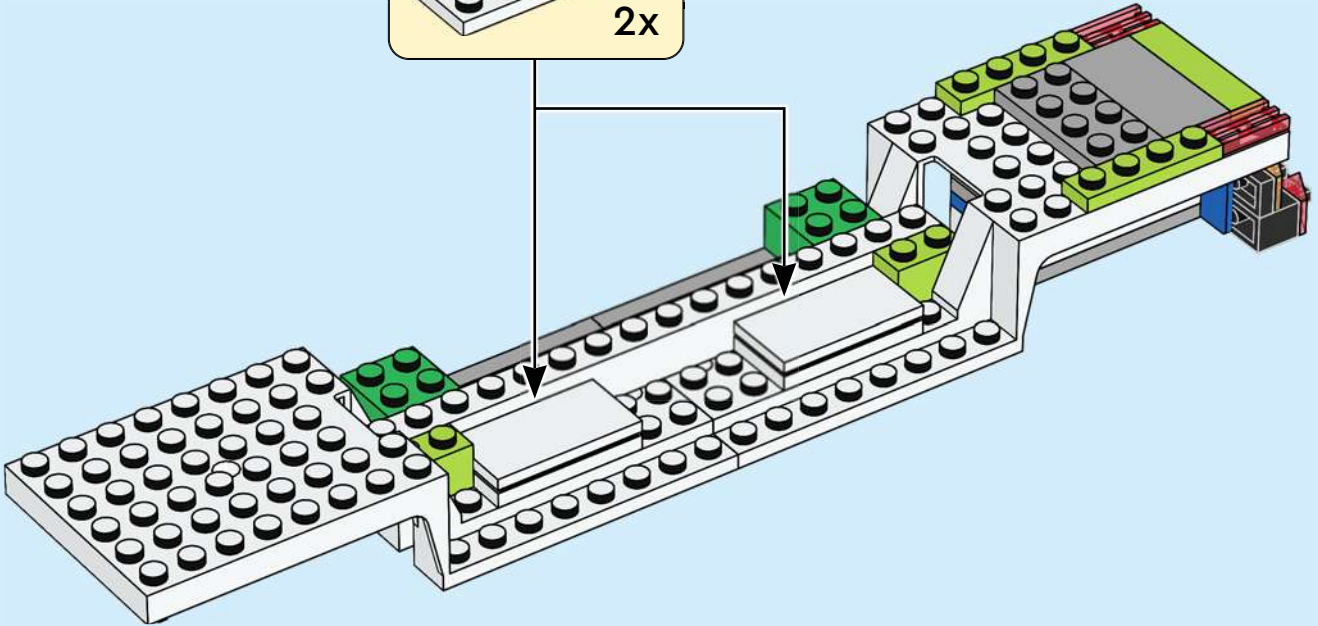
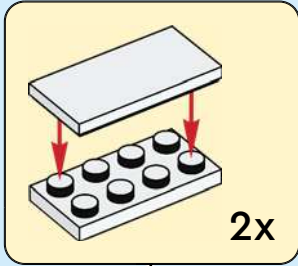

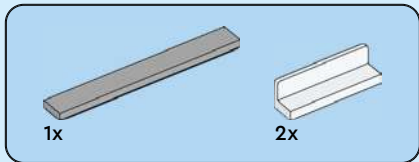

43

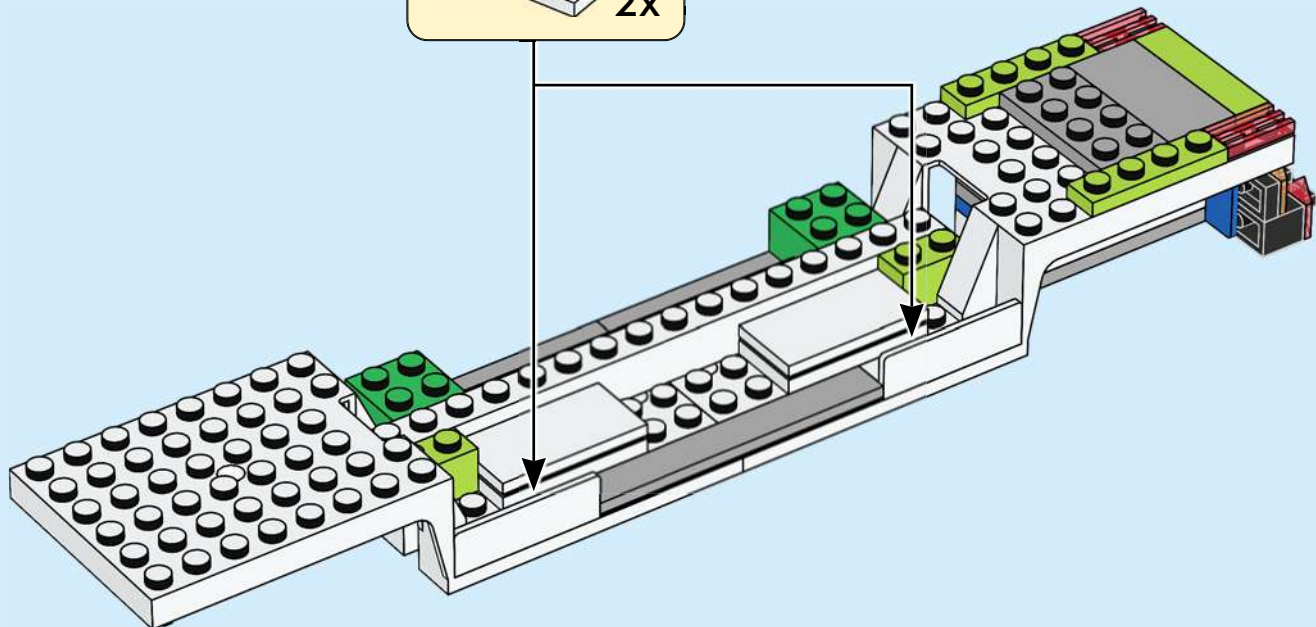
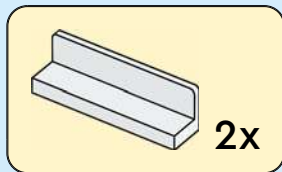



2x

44

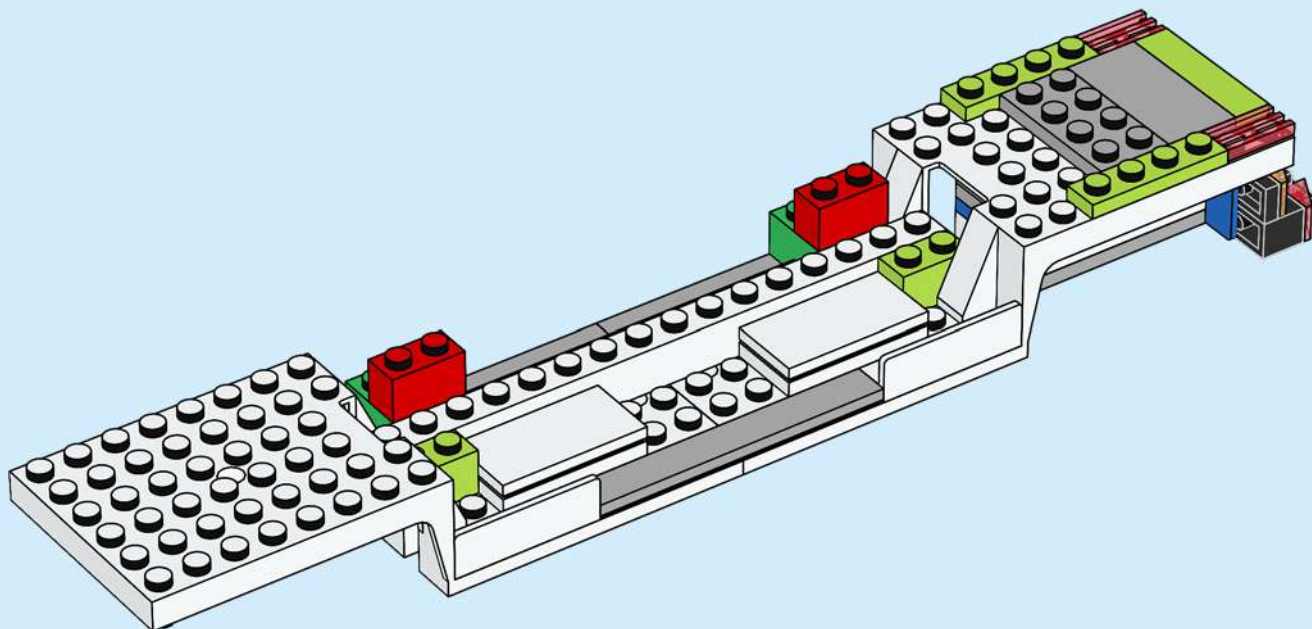

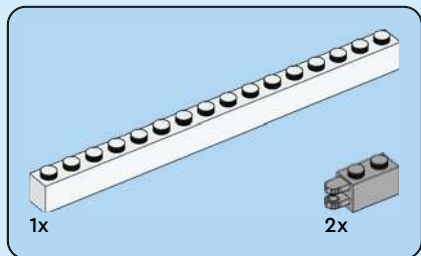

45

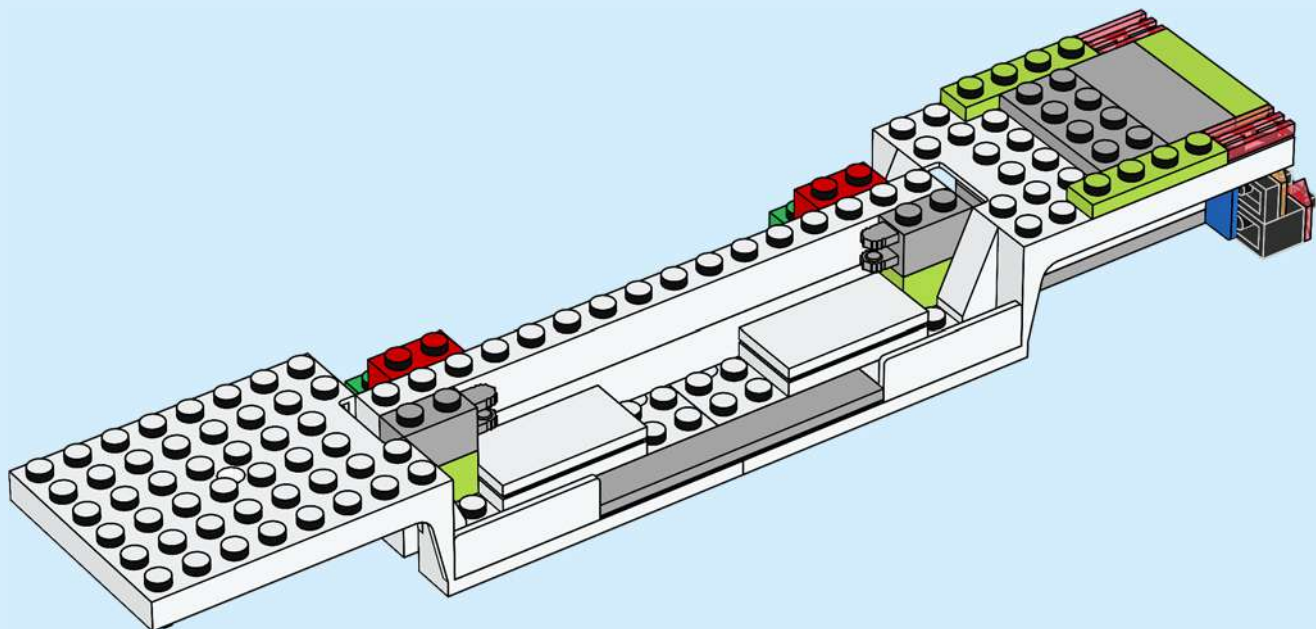

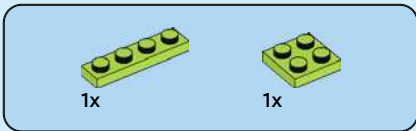

46

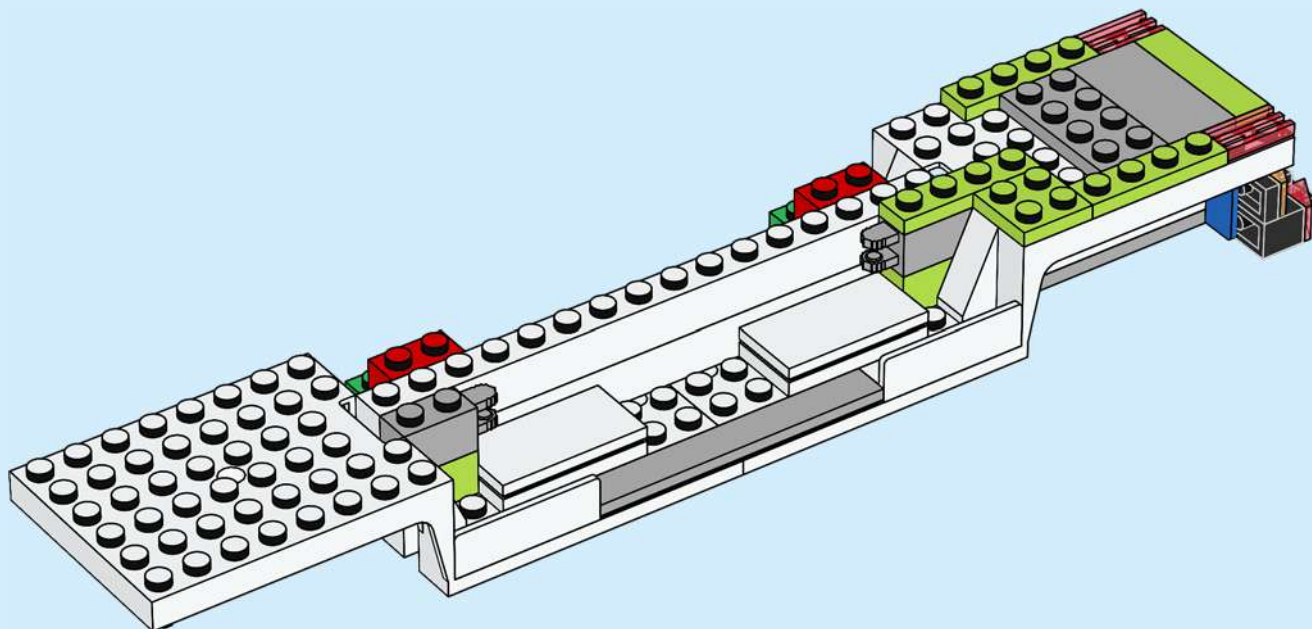

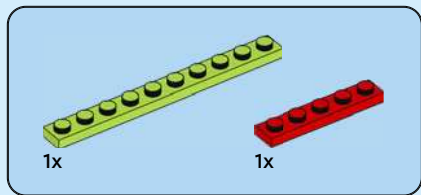

47

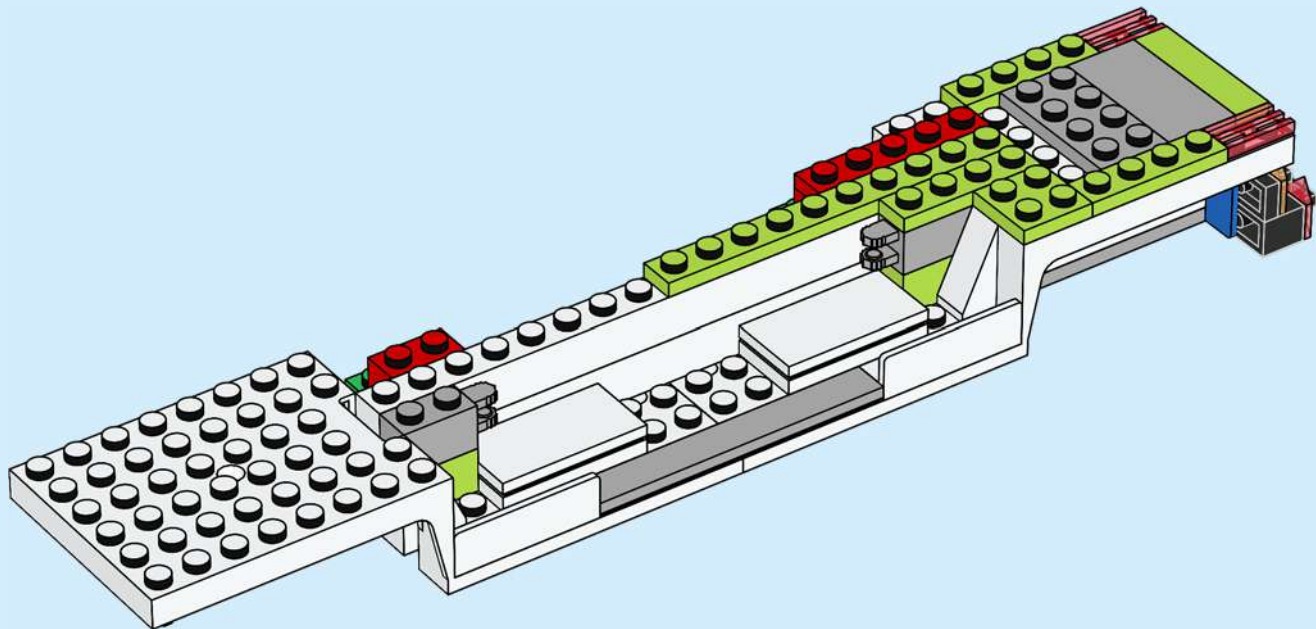

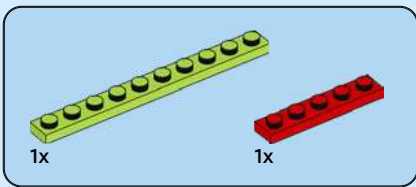

48

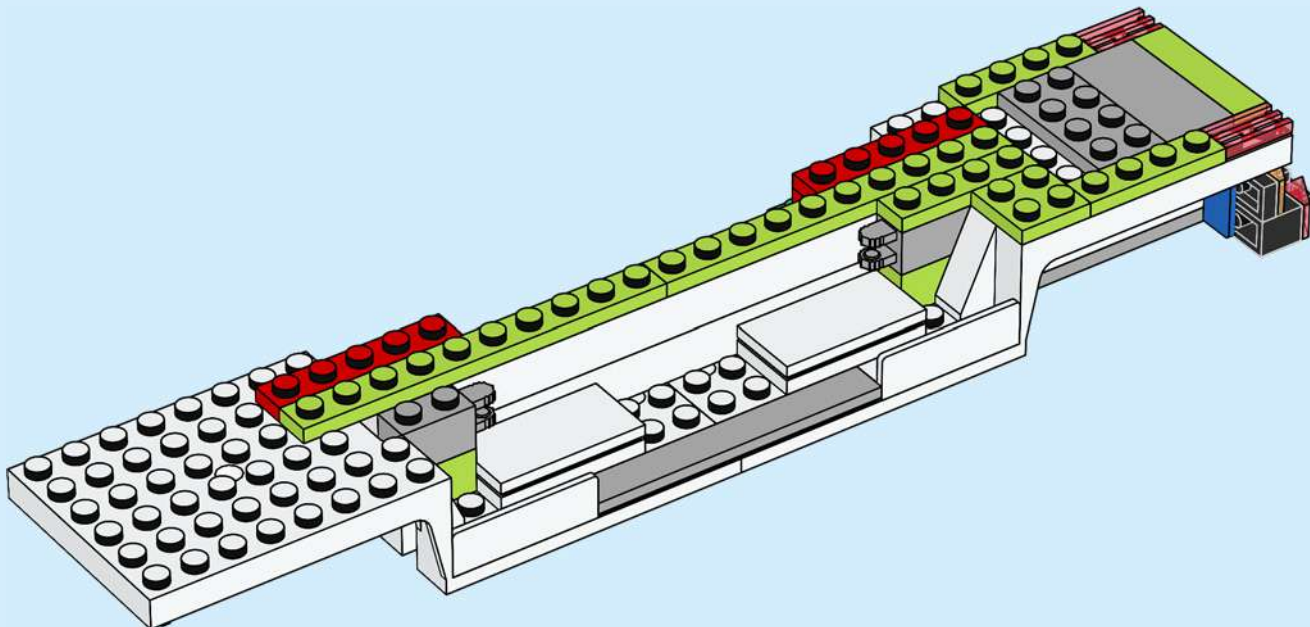

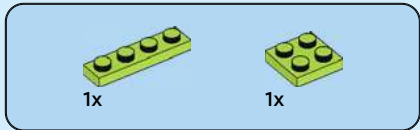

49

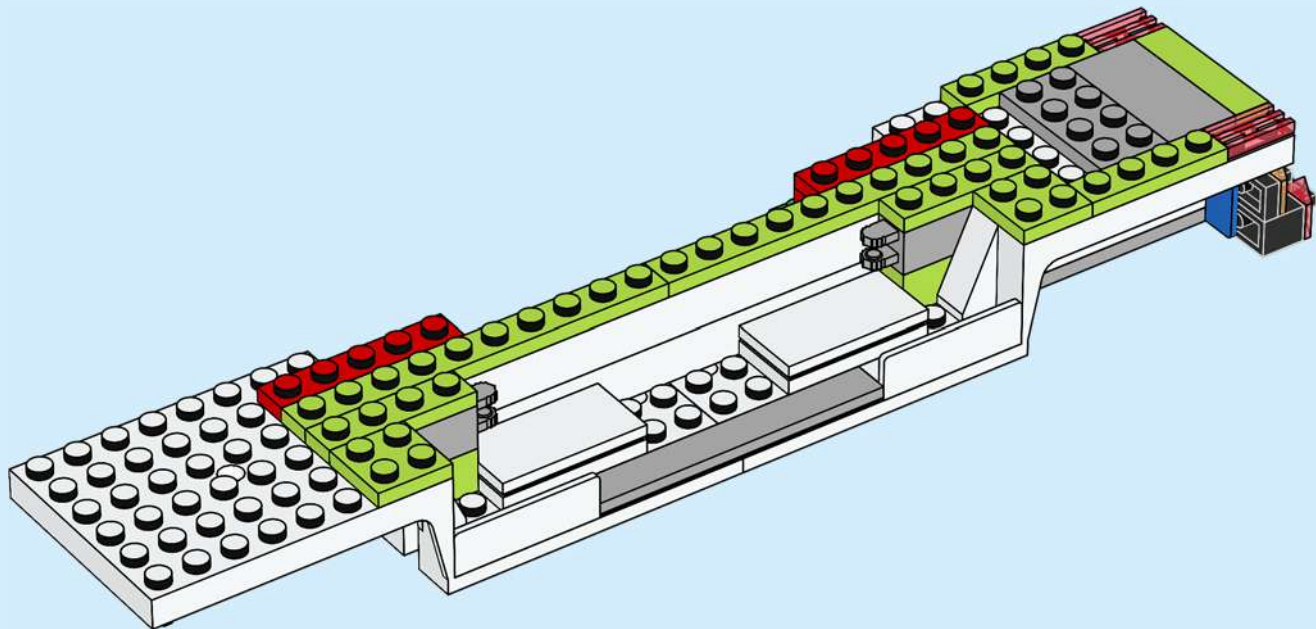

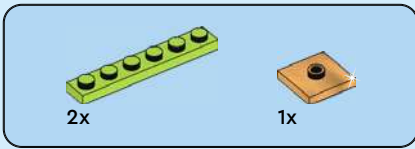

50

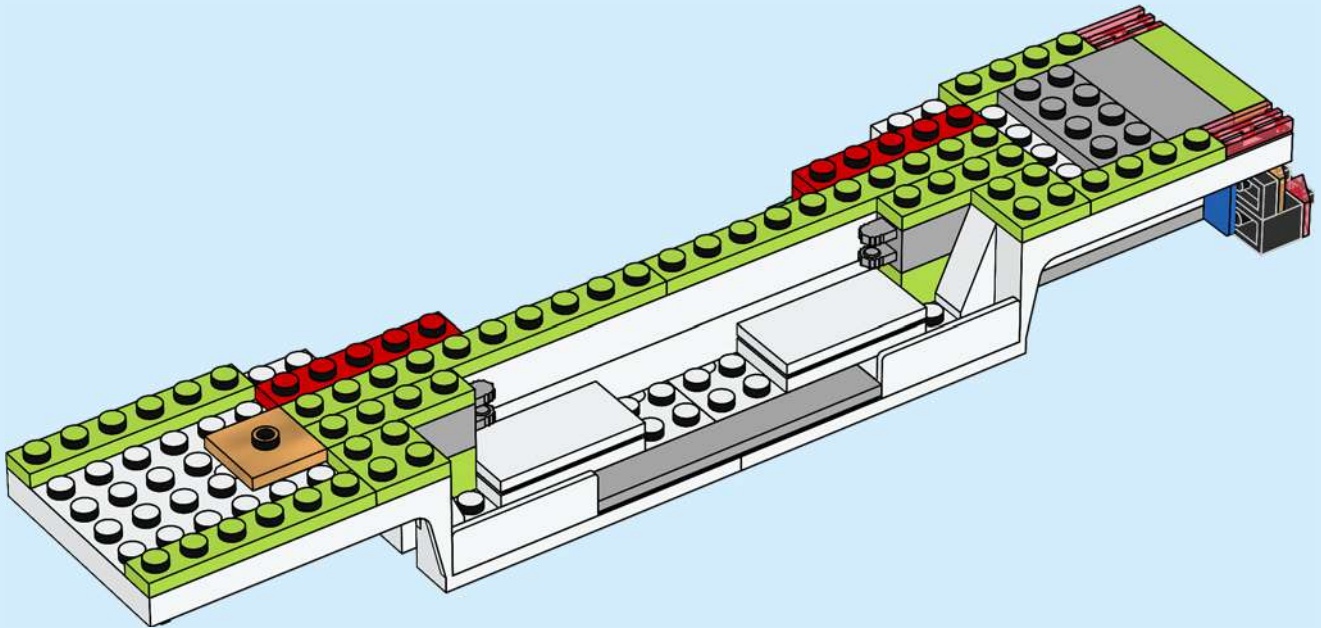

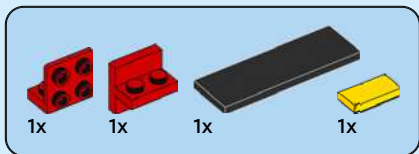

51

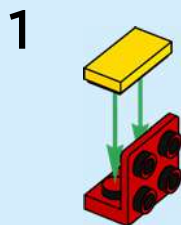
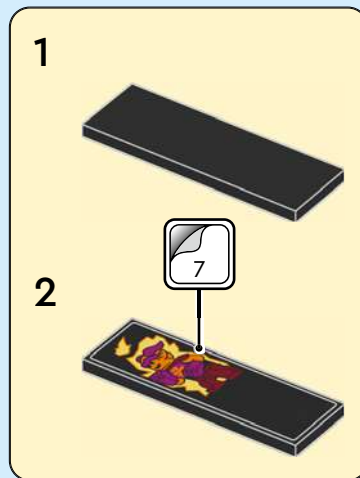

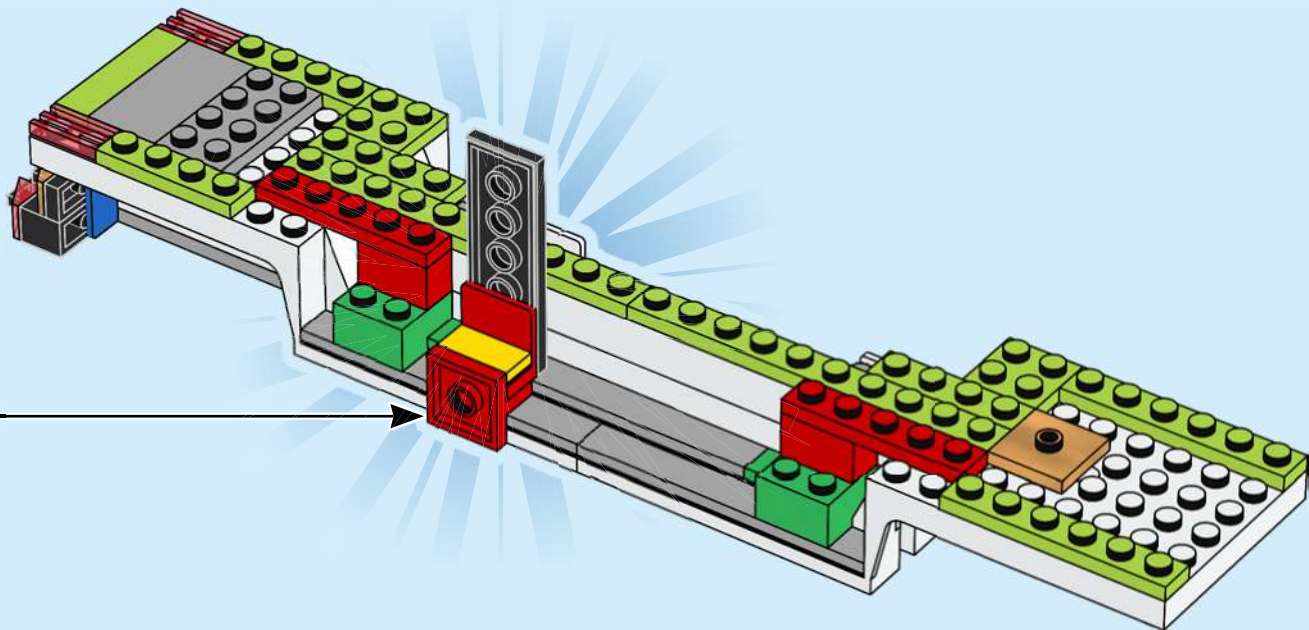

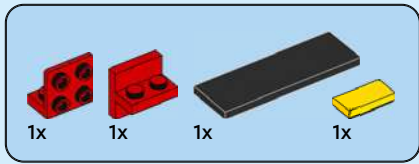

52

1



2



3

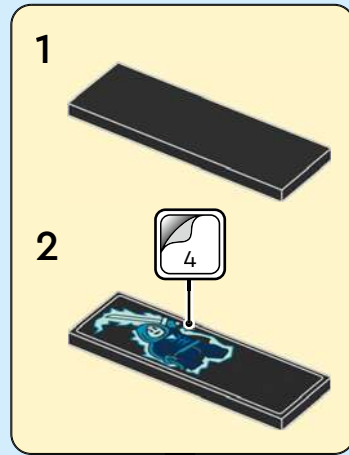

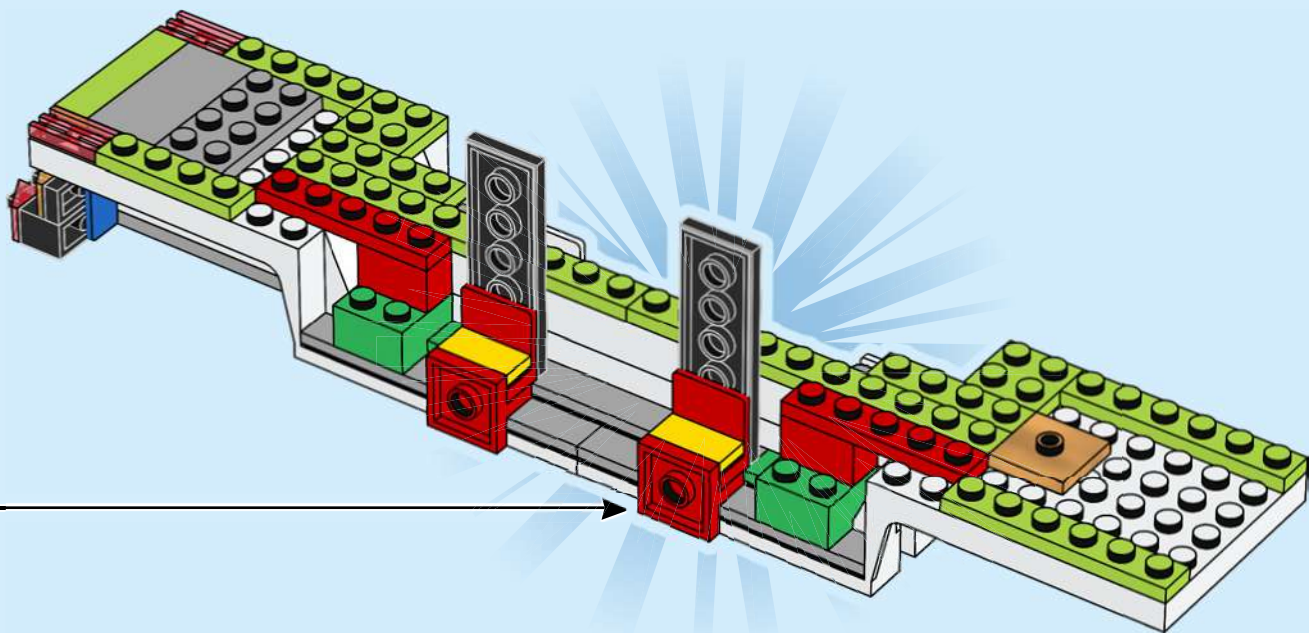

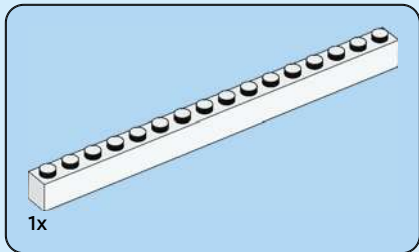

53

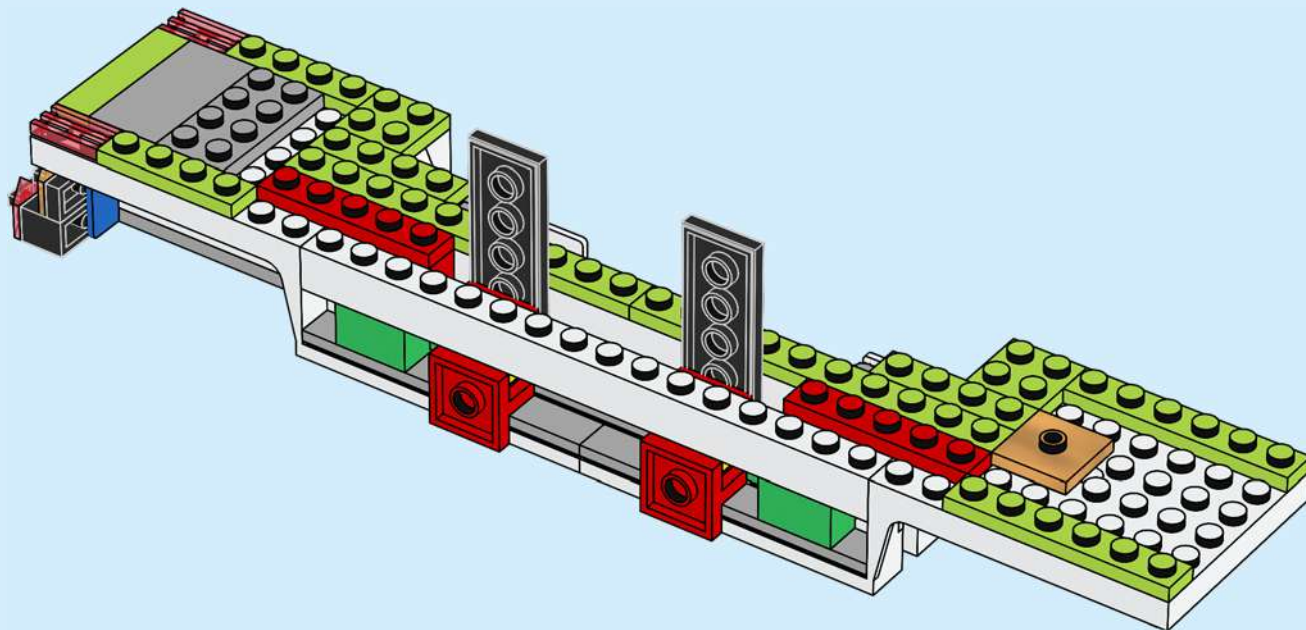

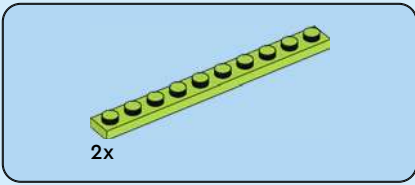

54

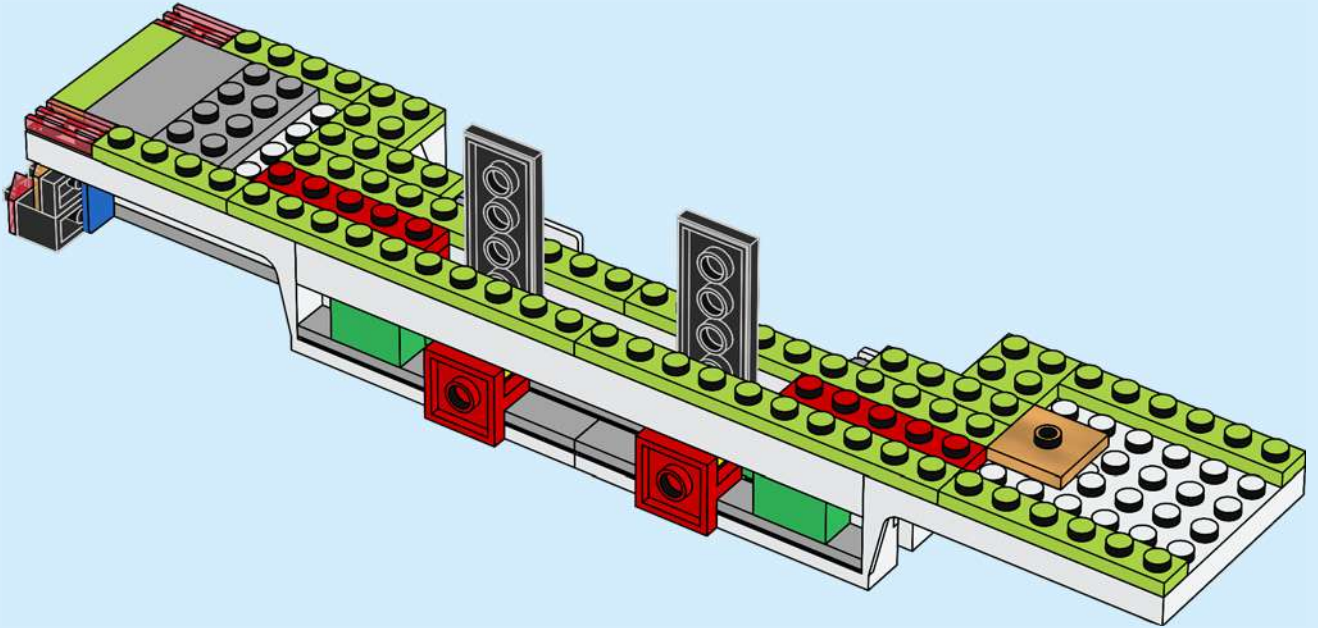

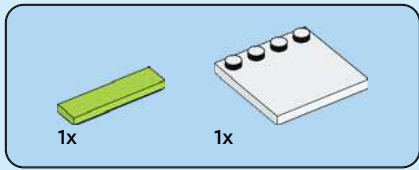

55

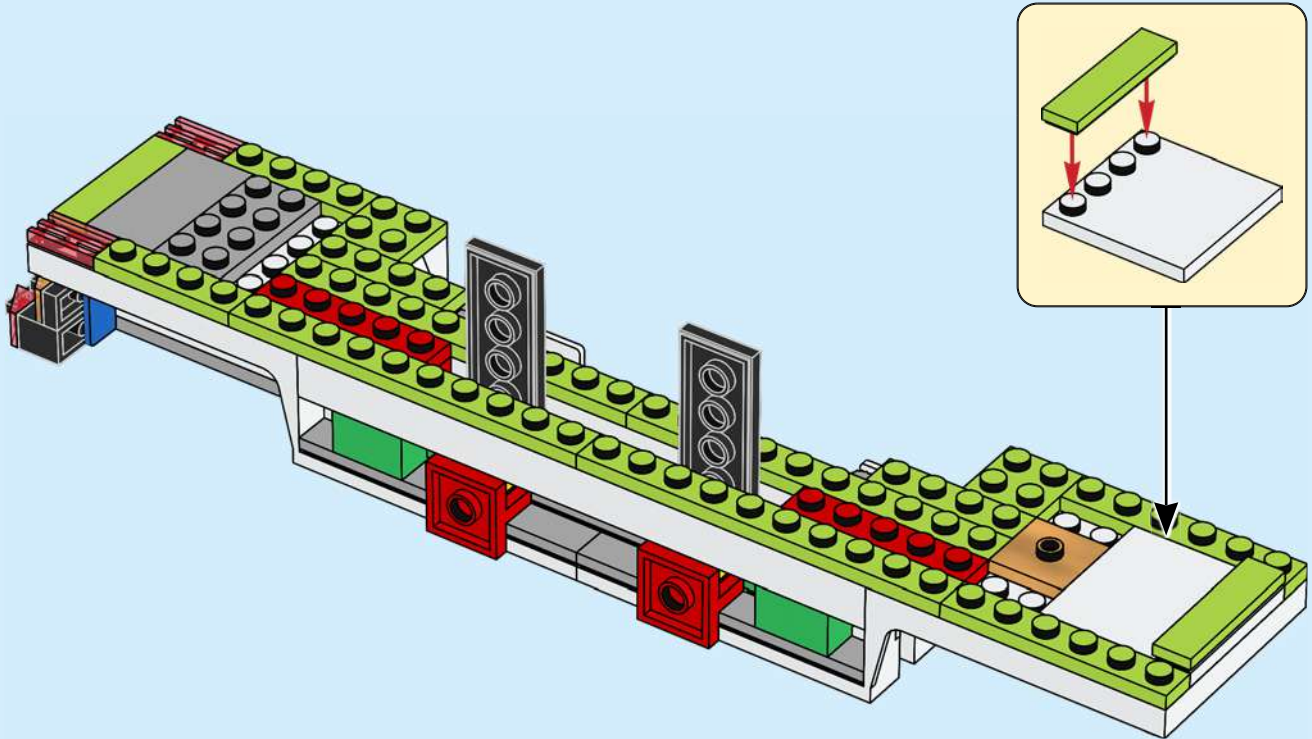

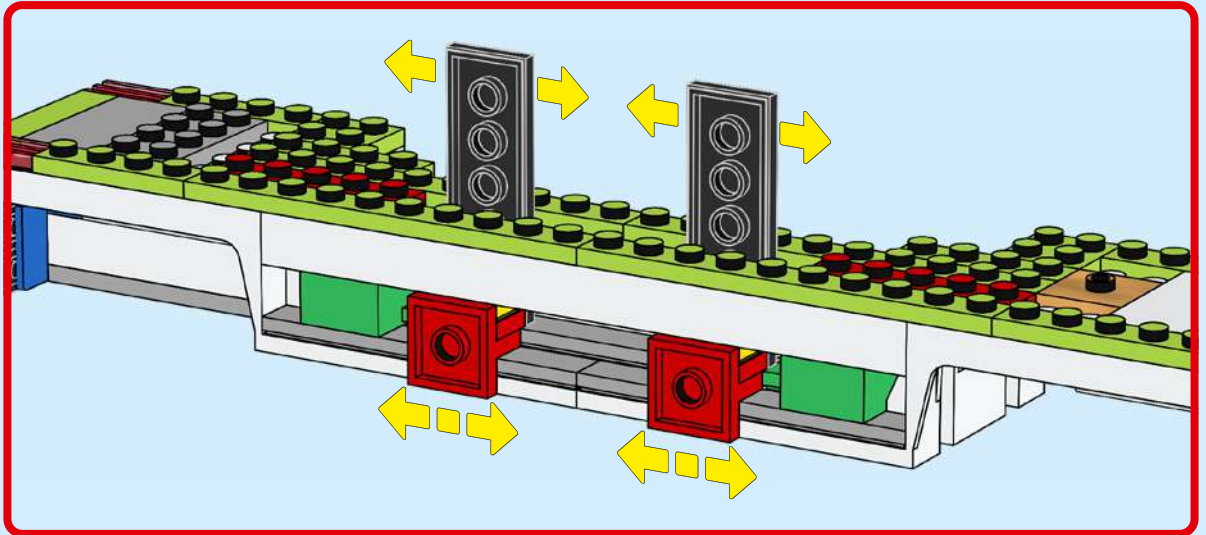



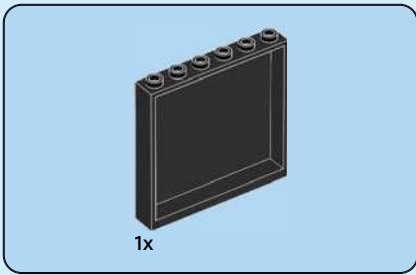

56

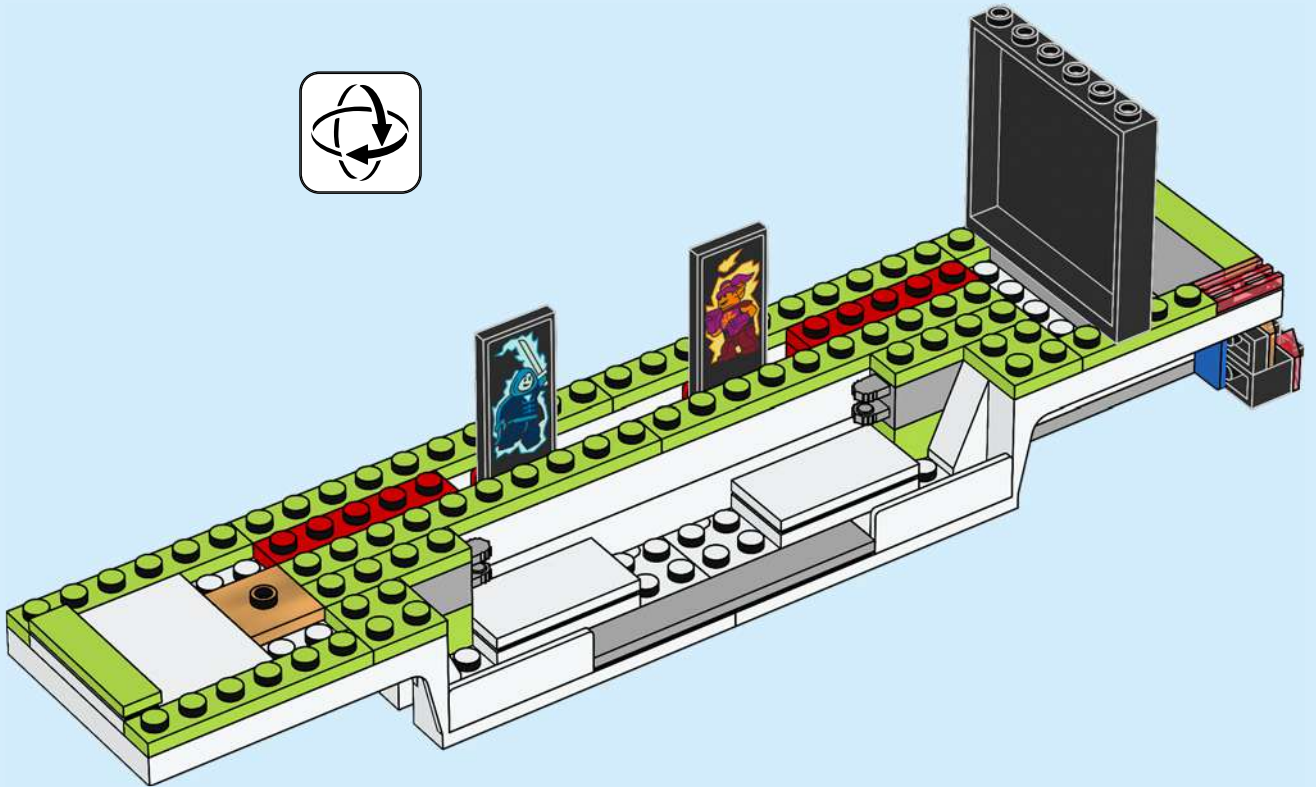
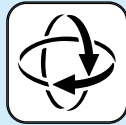

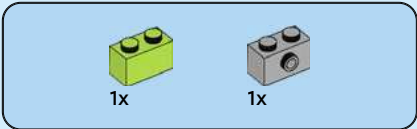

57

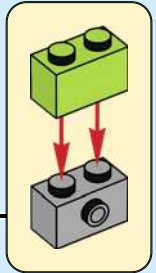
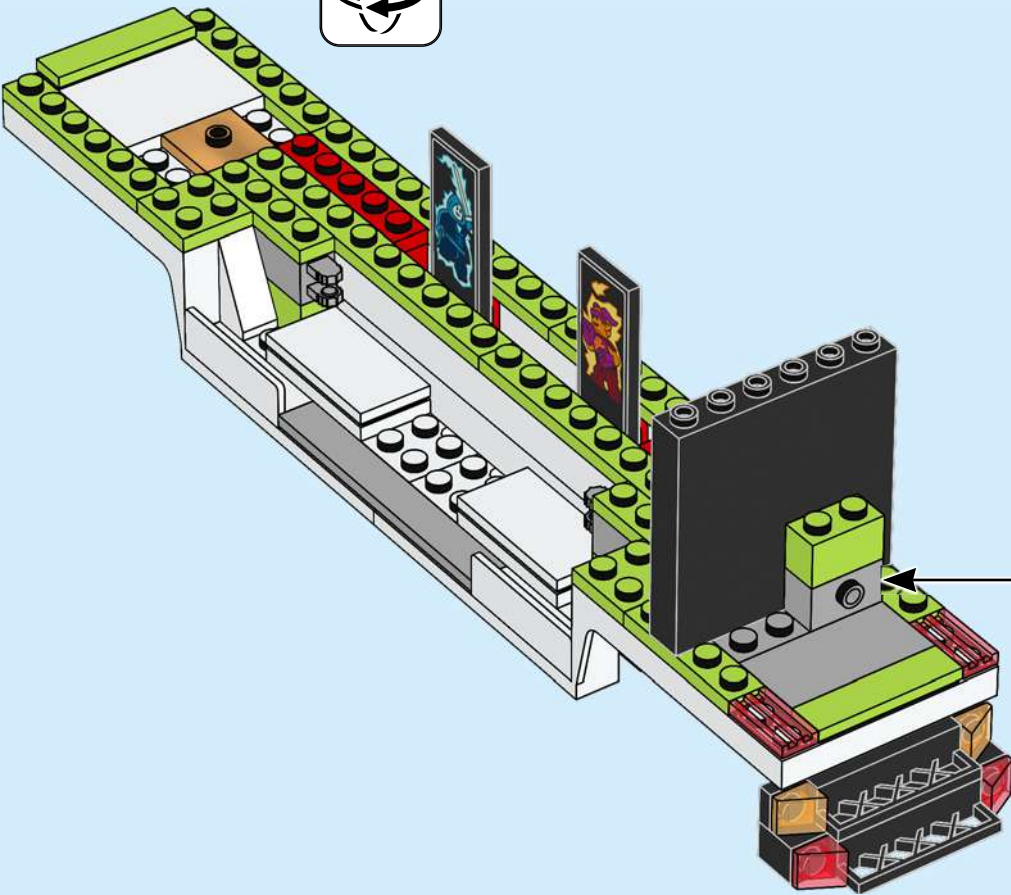
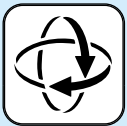



1x



1x

58

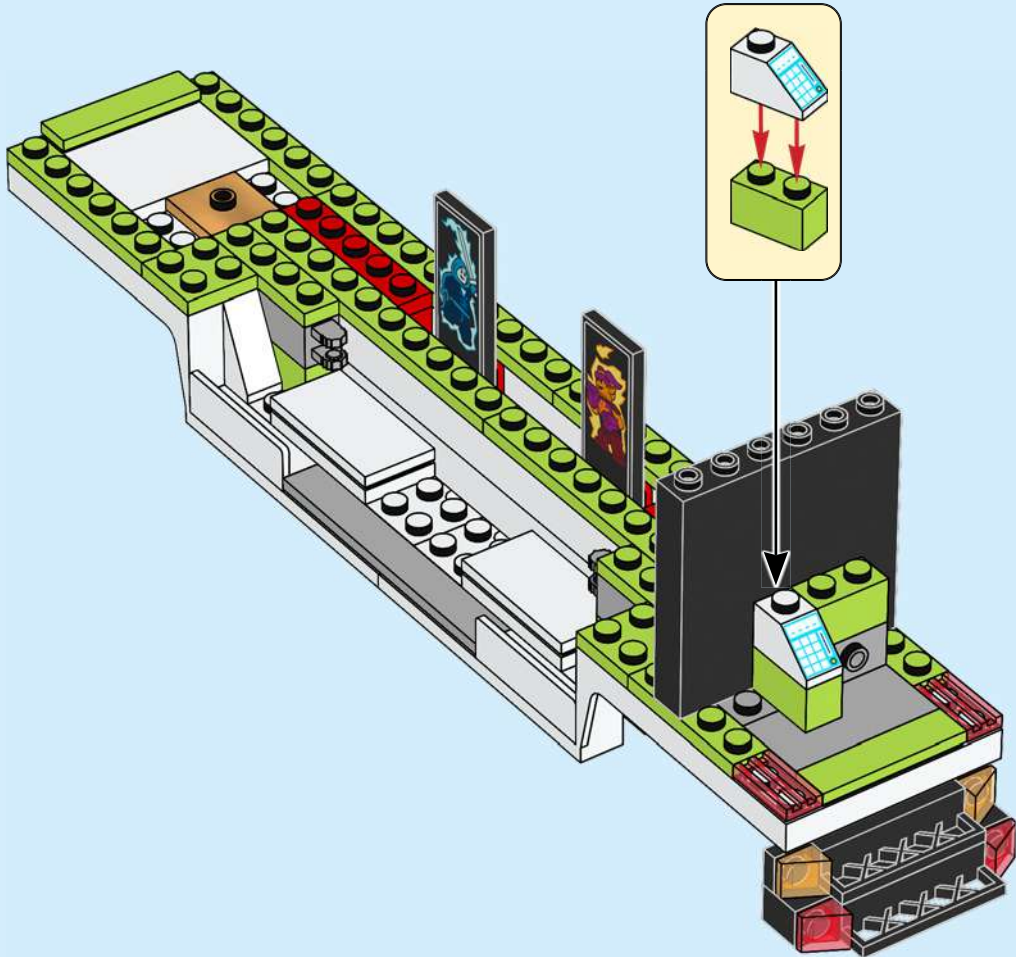



1x

60

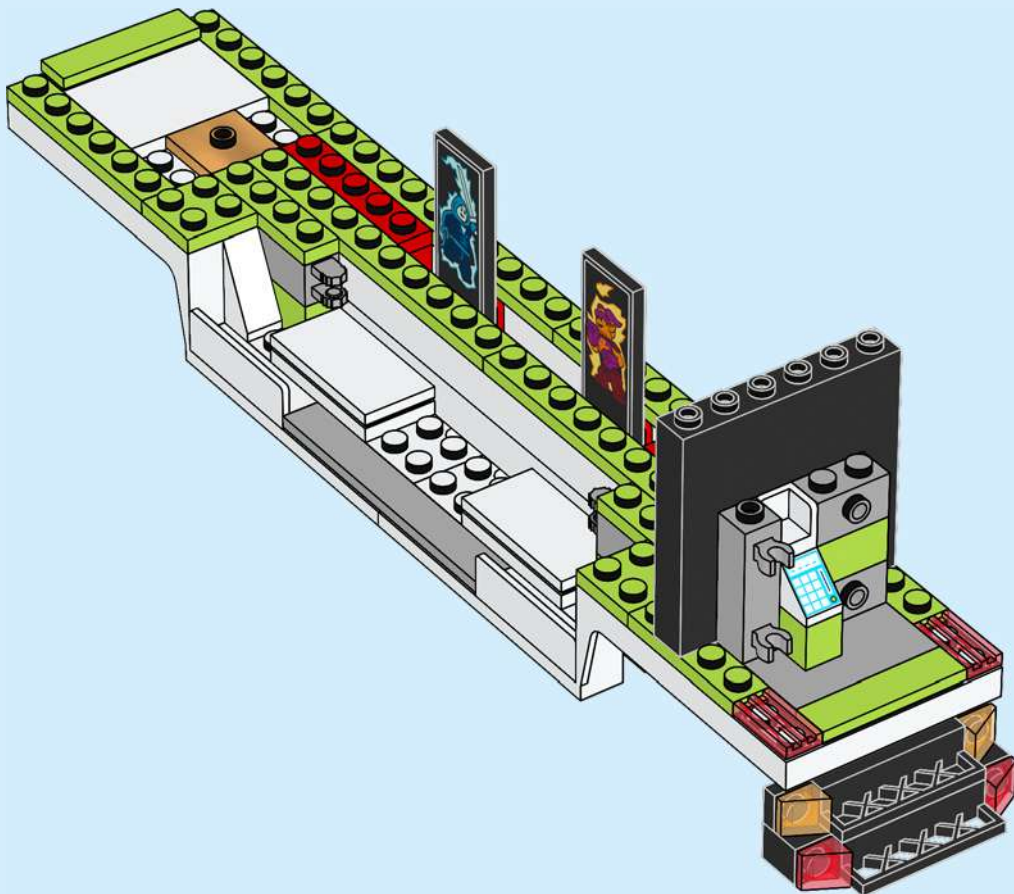



1x

61

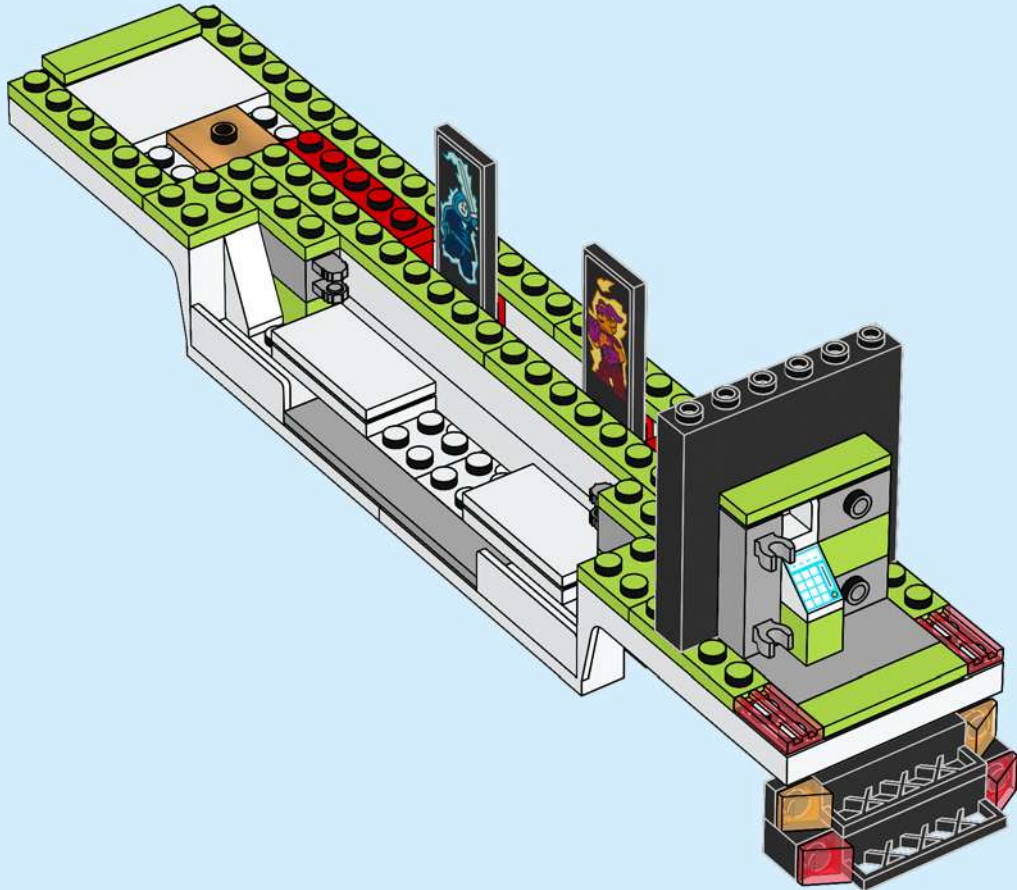

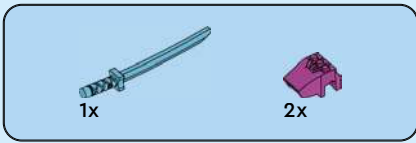

62

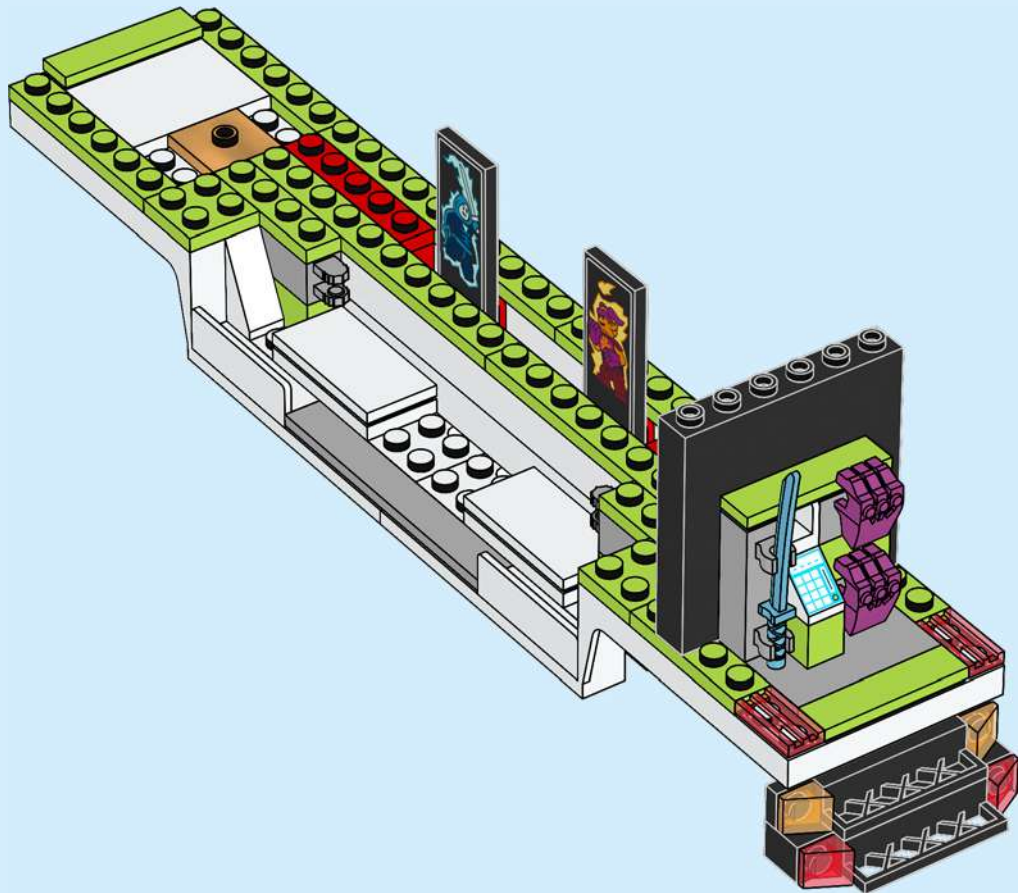



63

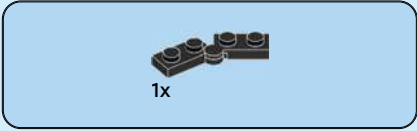

64



65

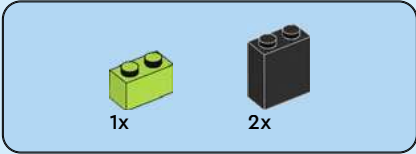
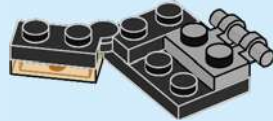

66

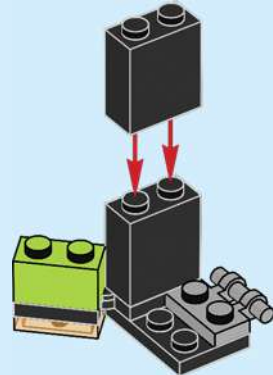

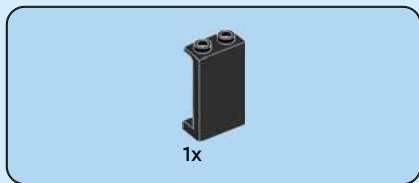

67

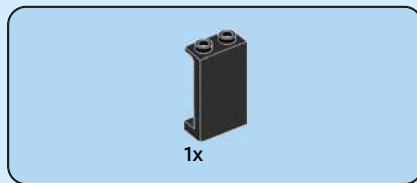
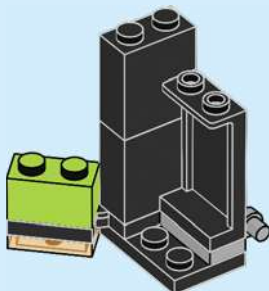

68

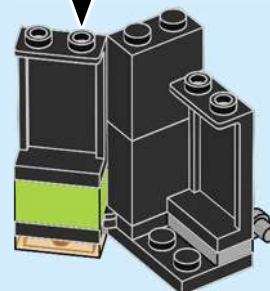
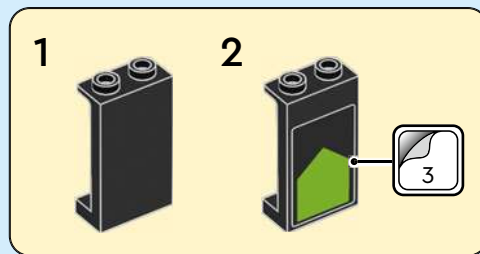



69

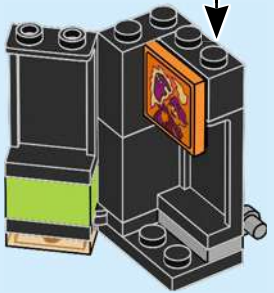
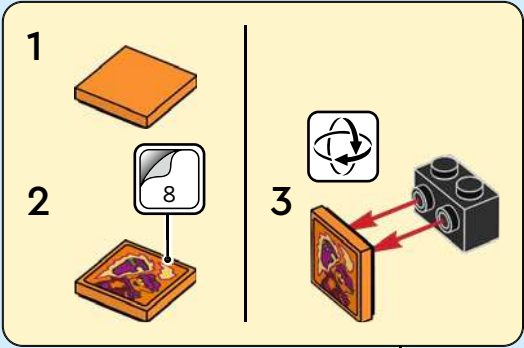

70

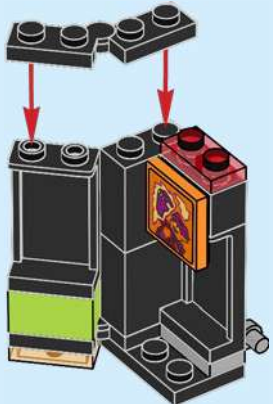

71

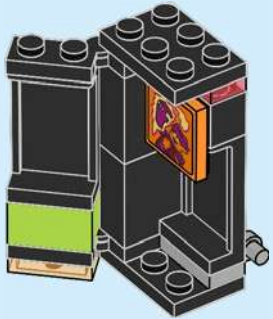

72

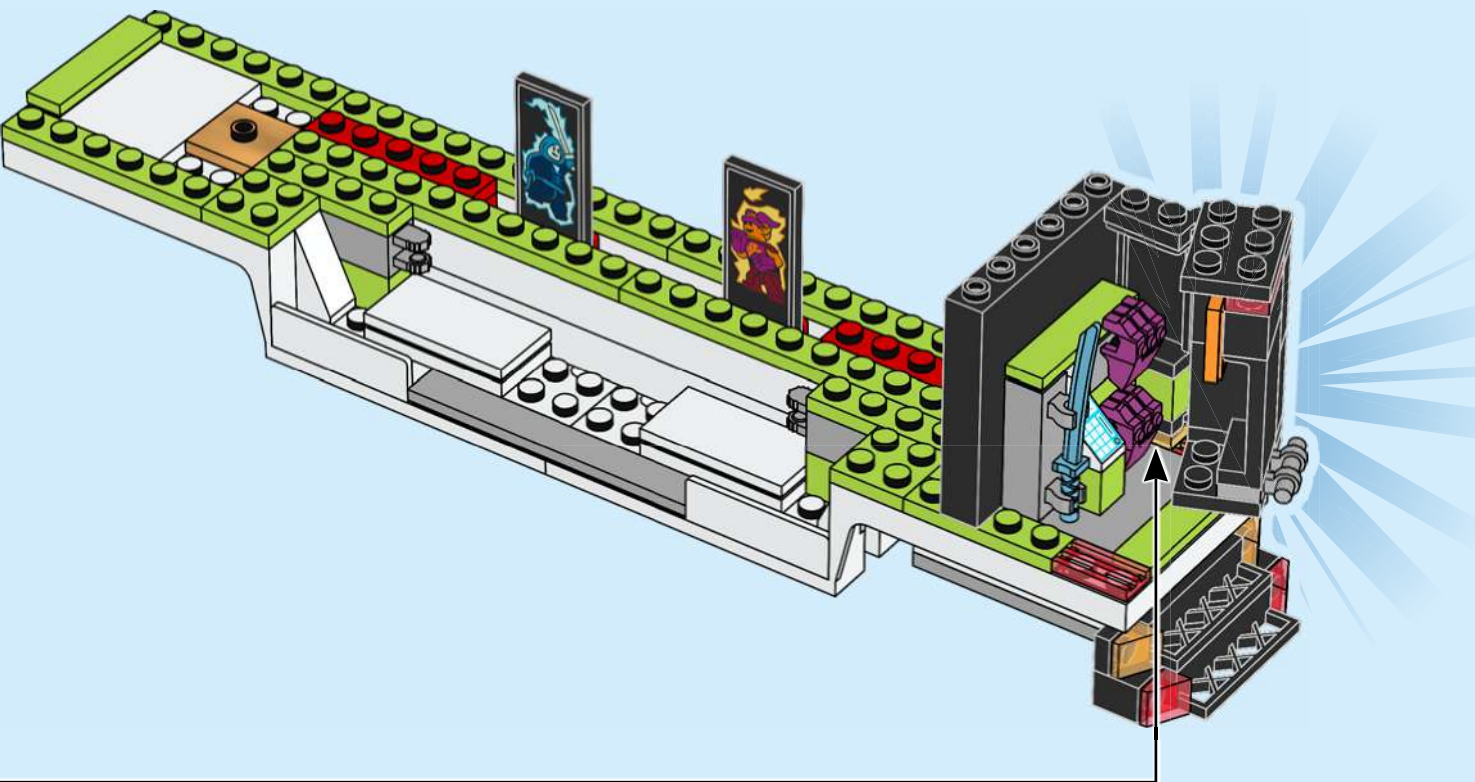



1x

1x

73



1x

74

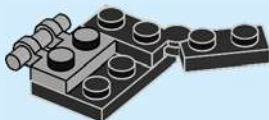

1x

75



1x



2x

76

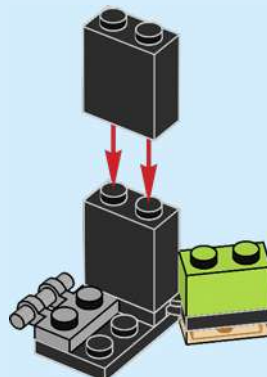

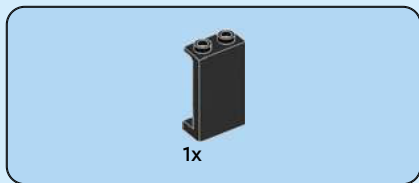

77

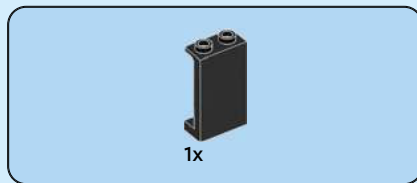
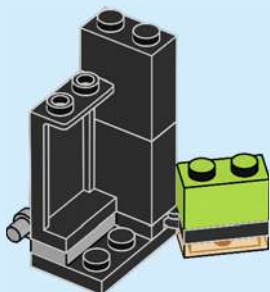

78

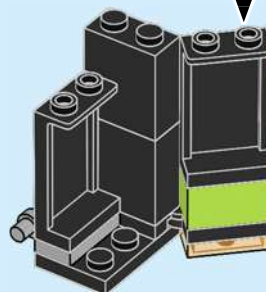
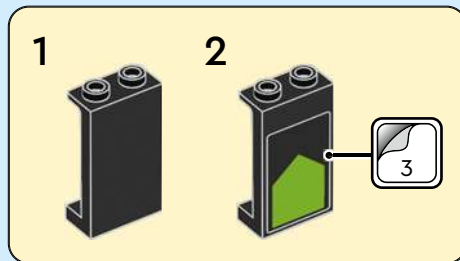

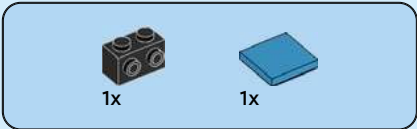

79

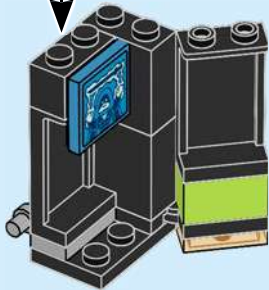
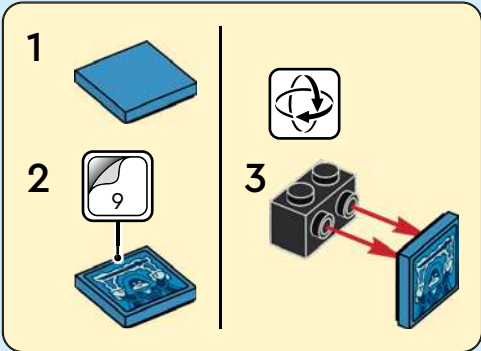

80

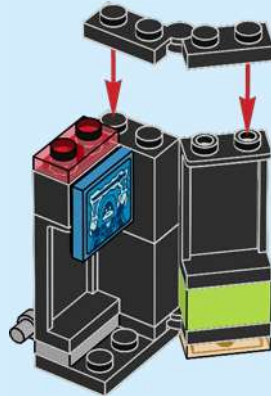

81

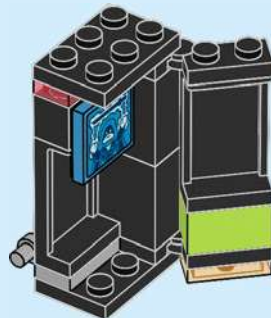

82

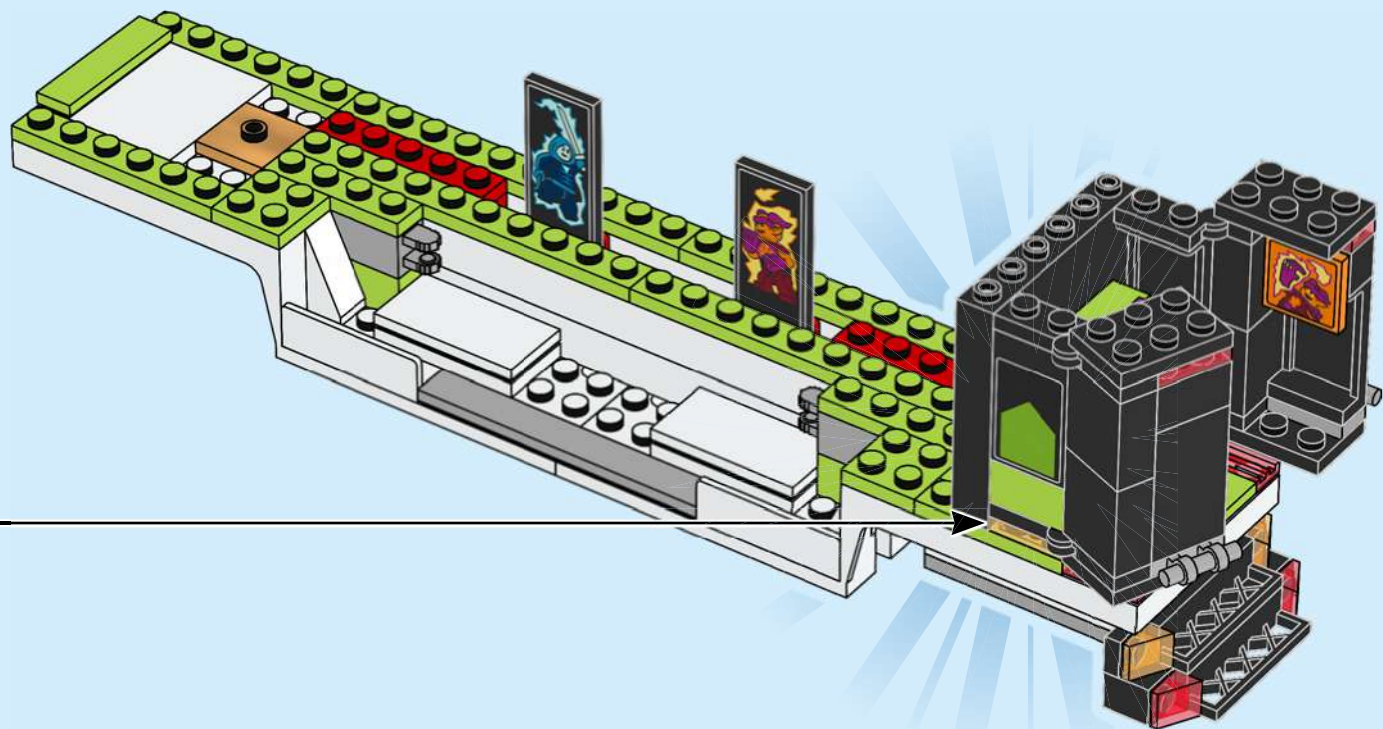

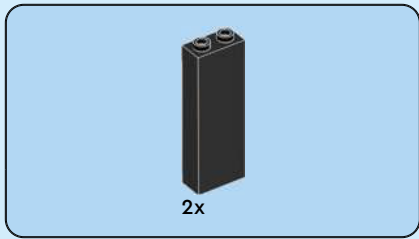

83

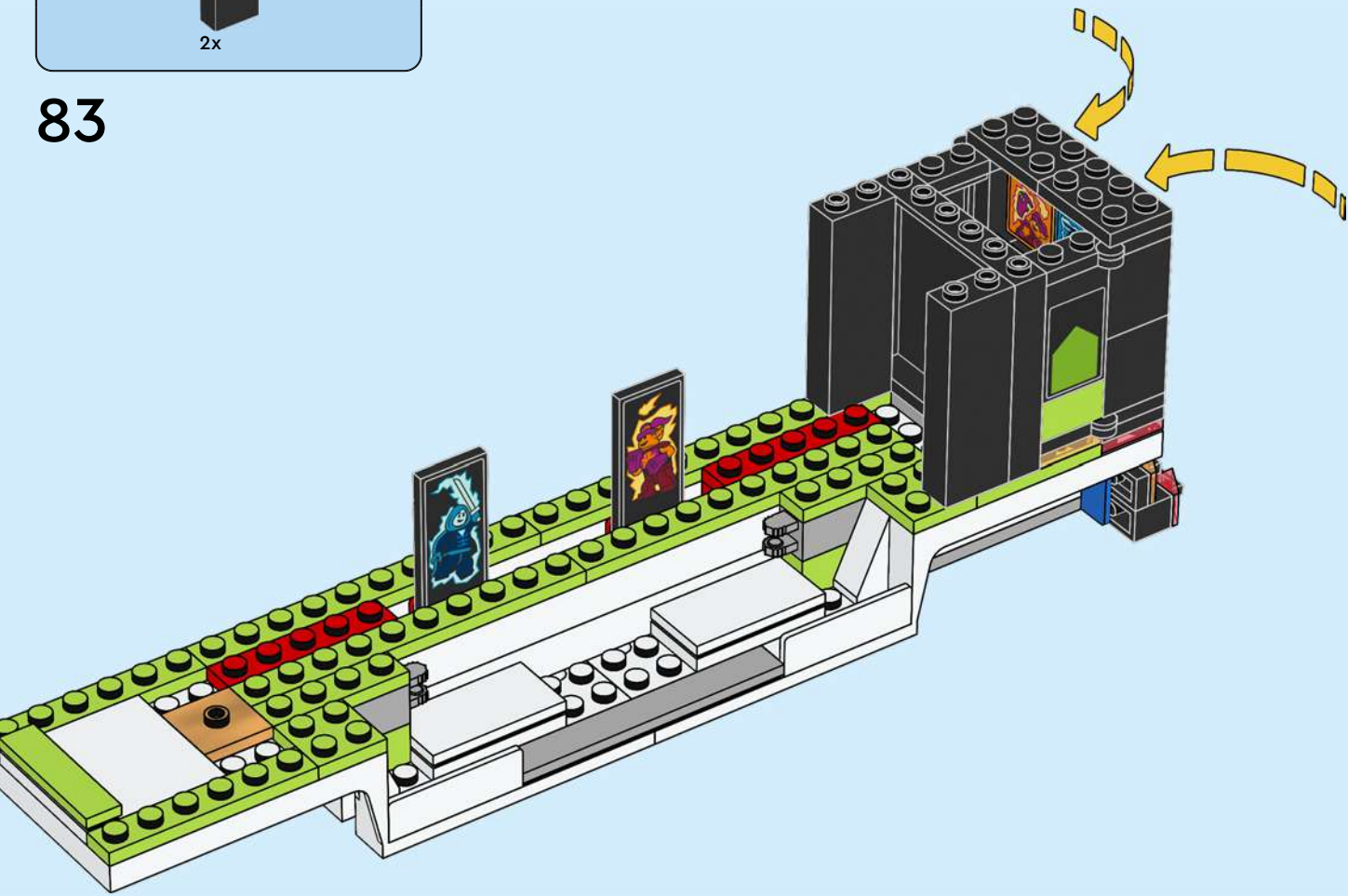

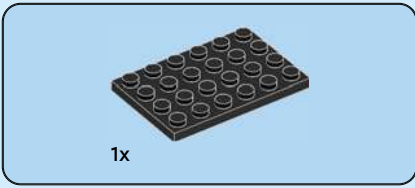

84

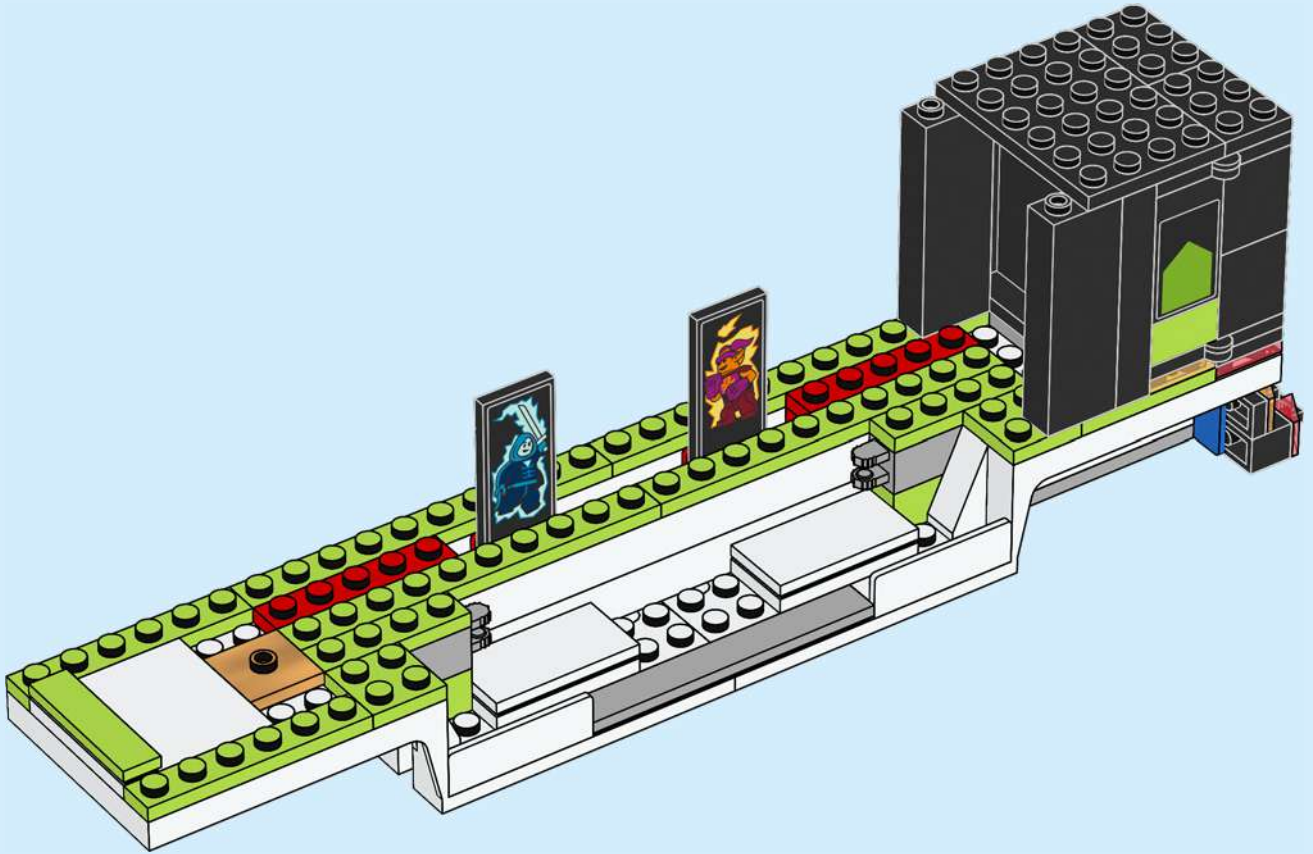



4x

85

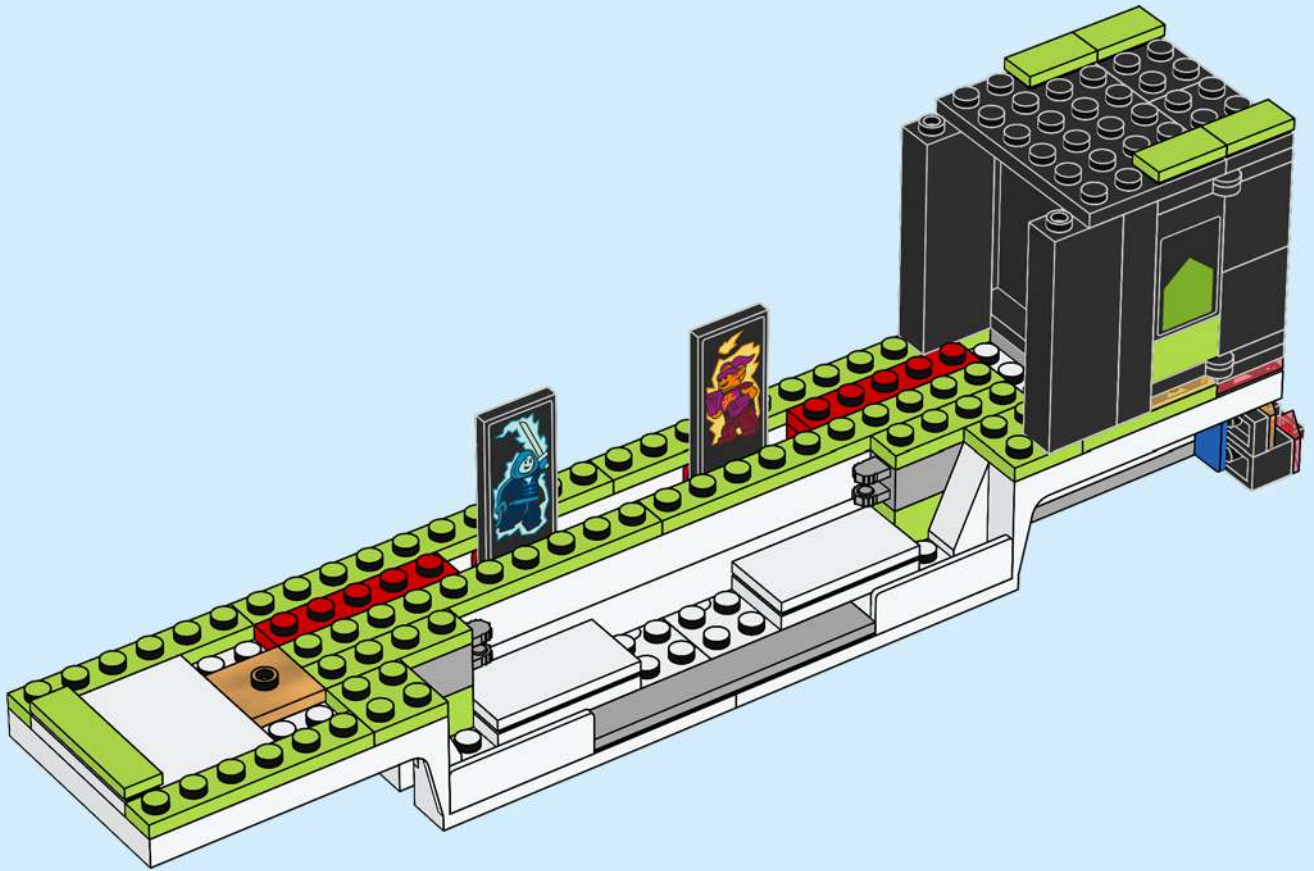

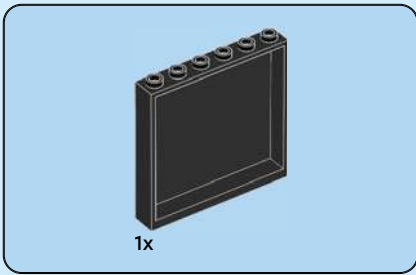

86

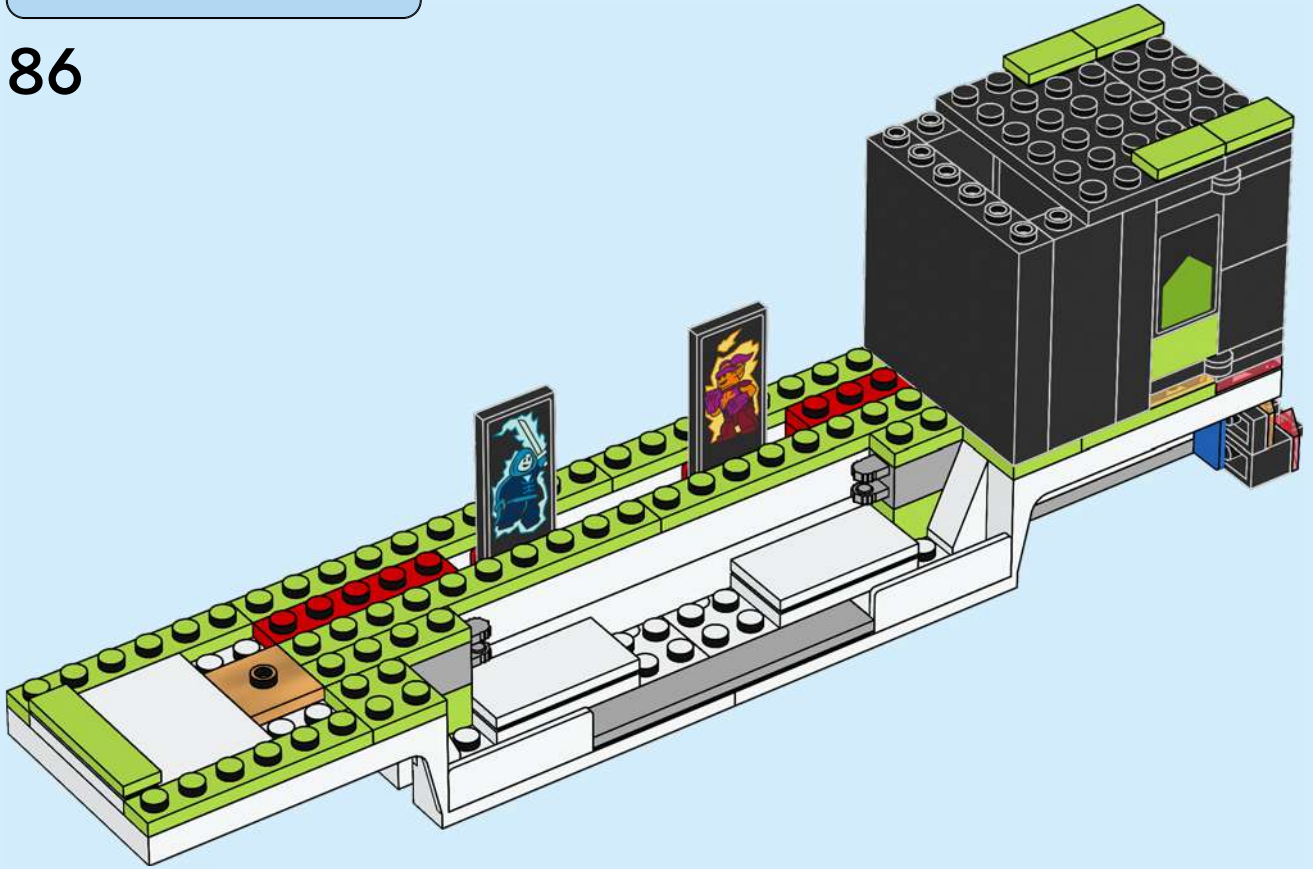

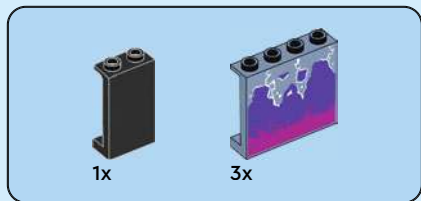

87

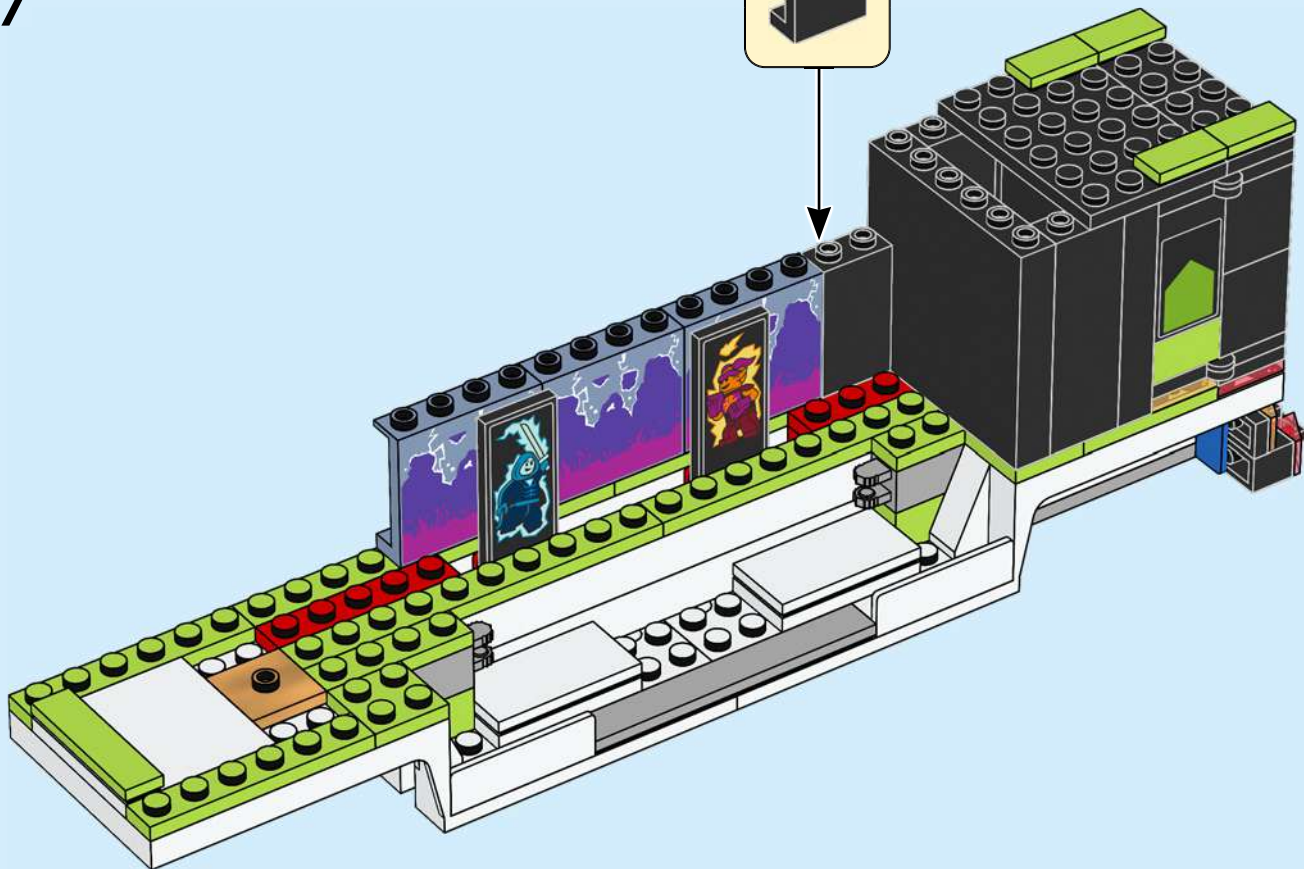
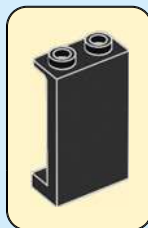

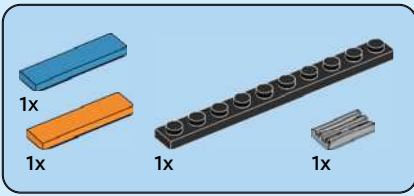

88

1

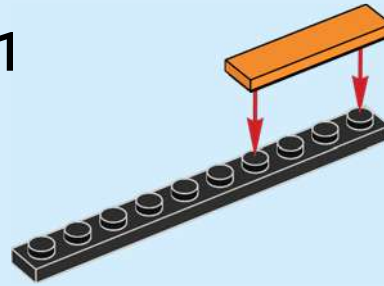

2

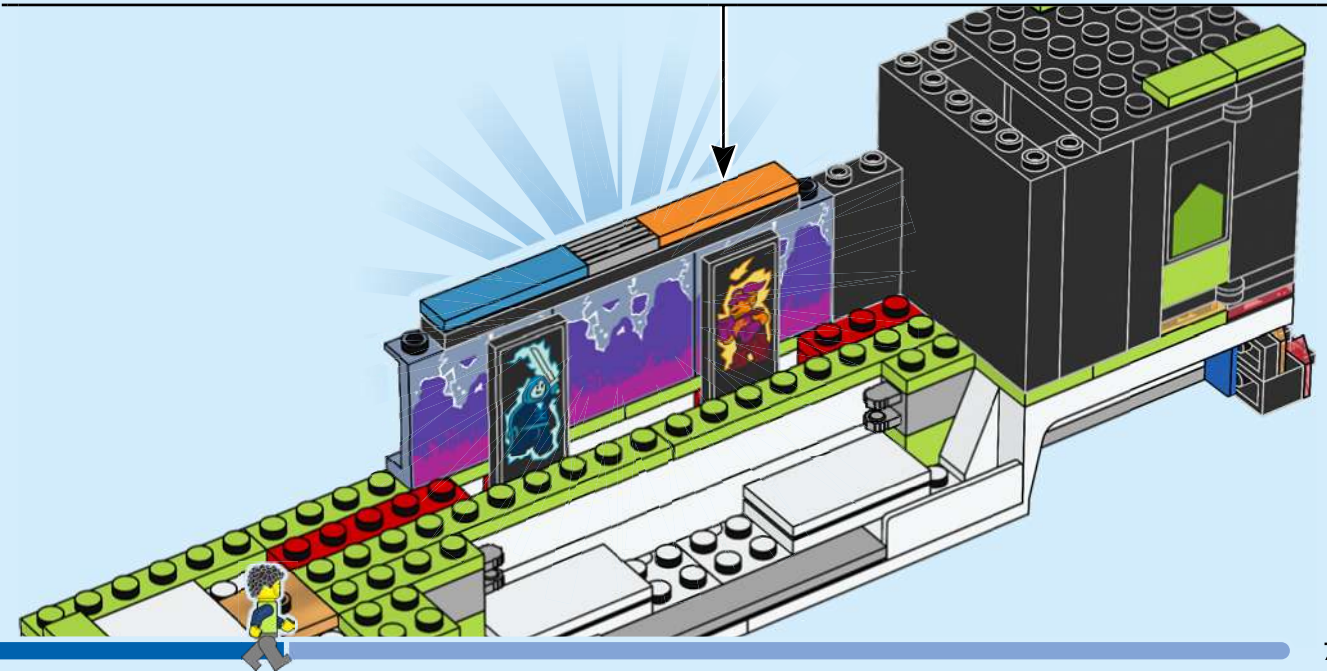
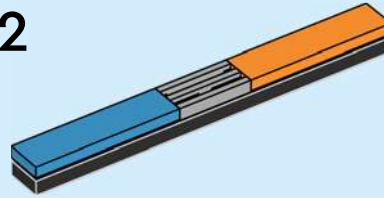

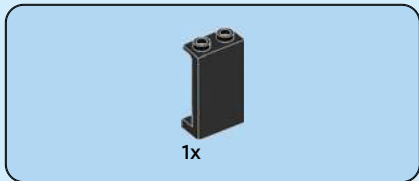

89

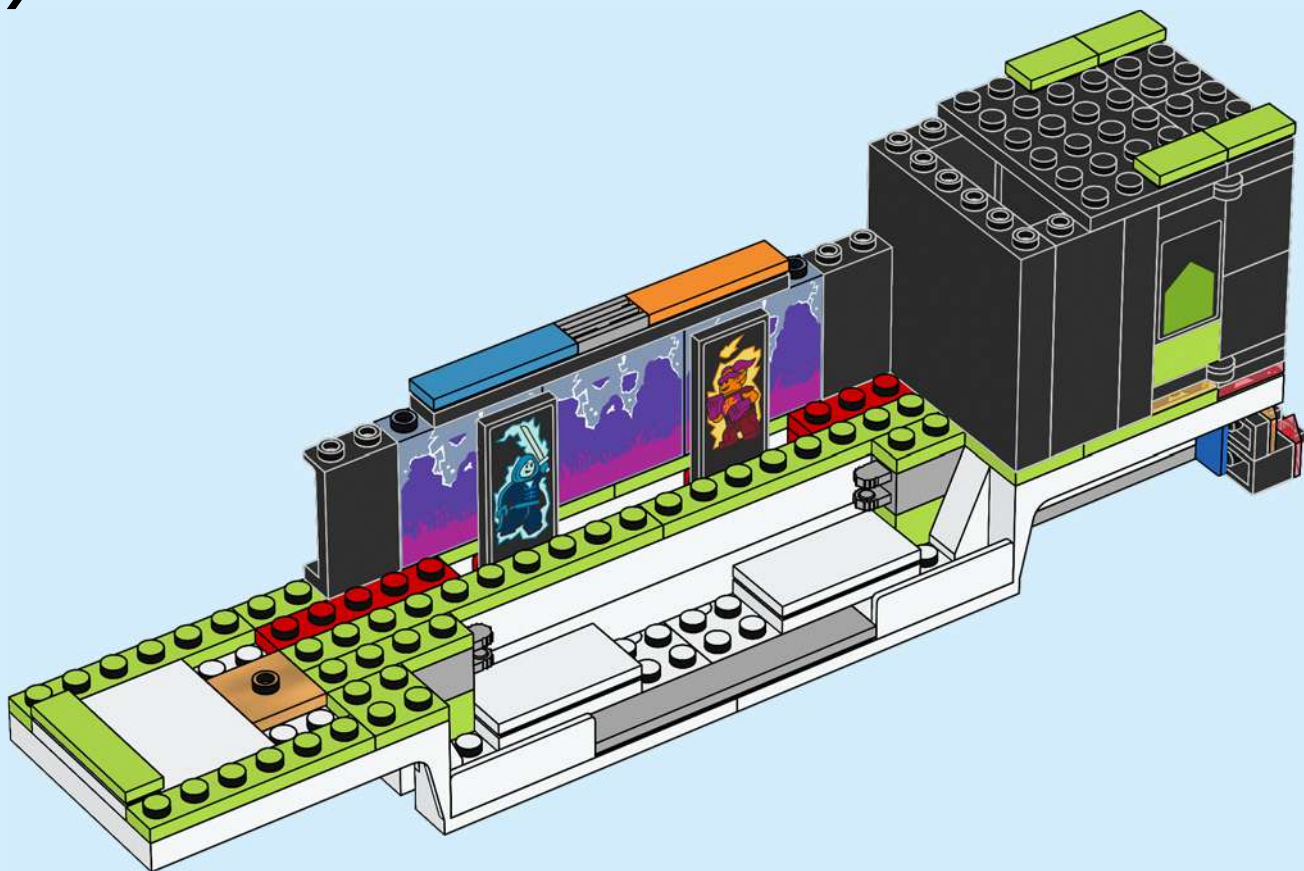

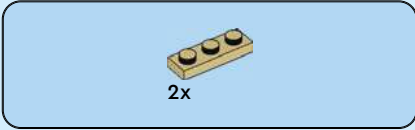
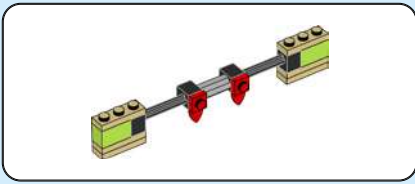

90

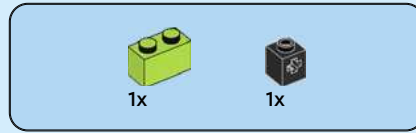
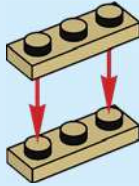

91

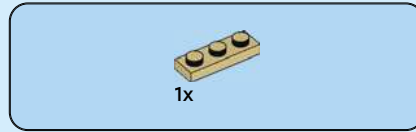

92



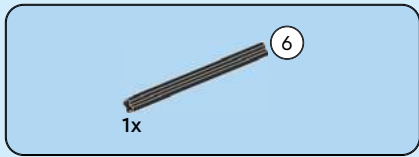

93

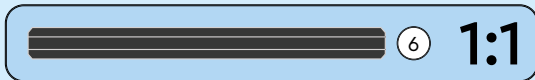
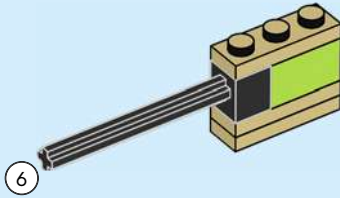

94

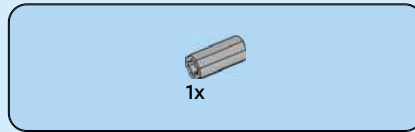
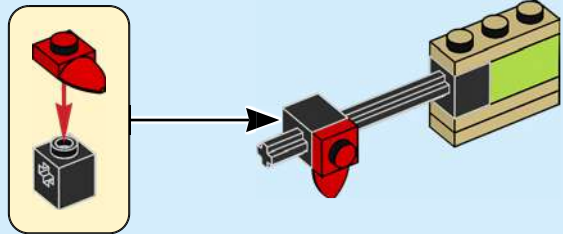

95

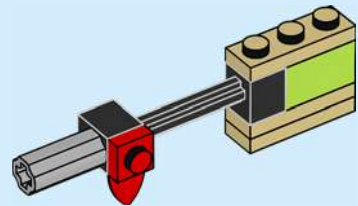

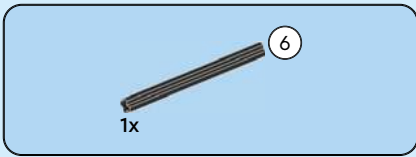

96

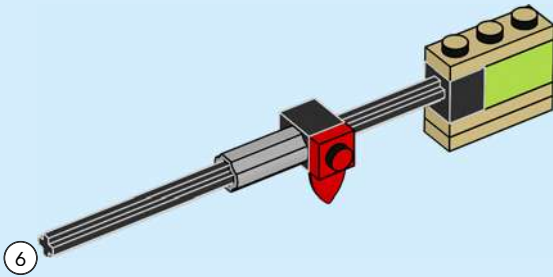

97

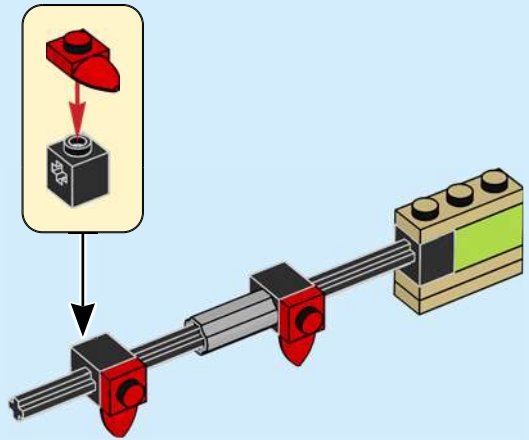

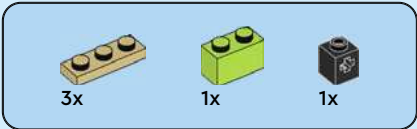

98

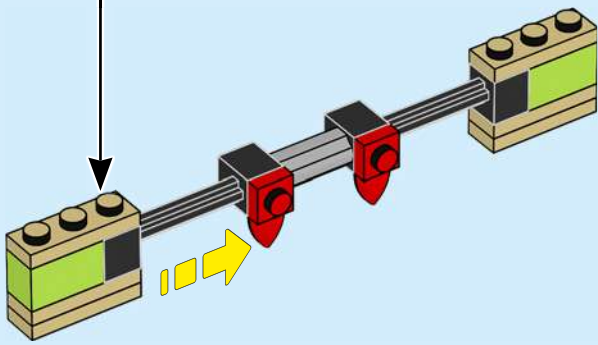
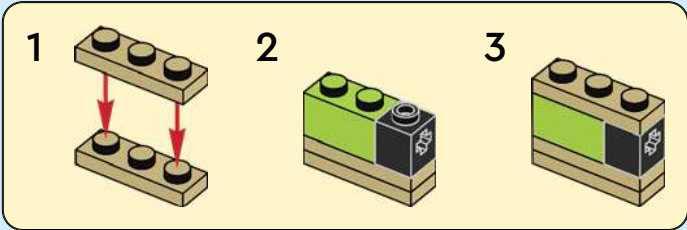

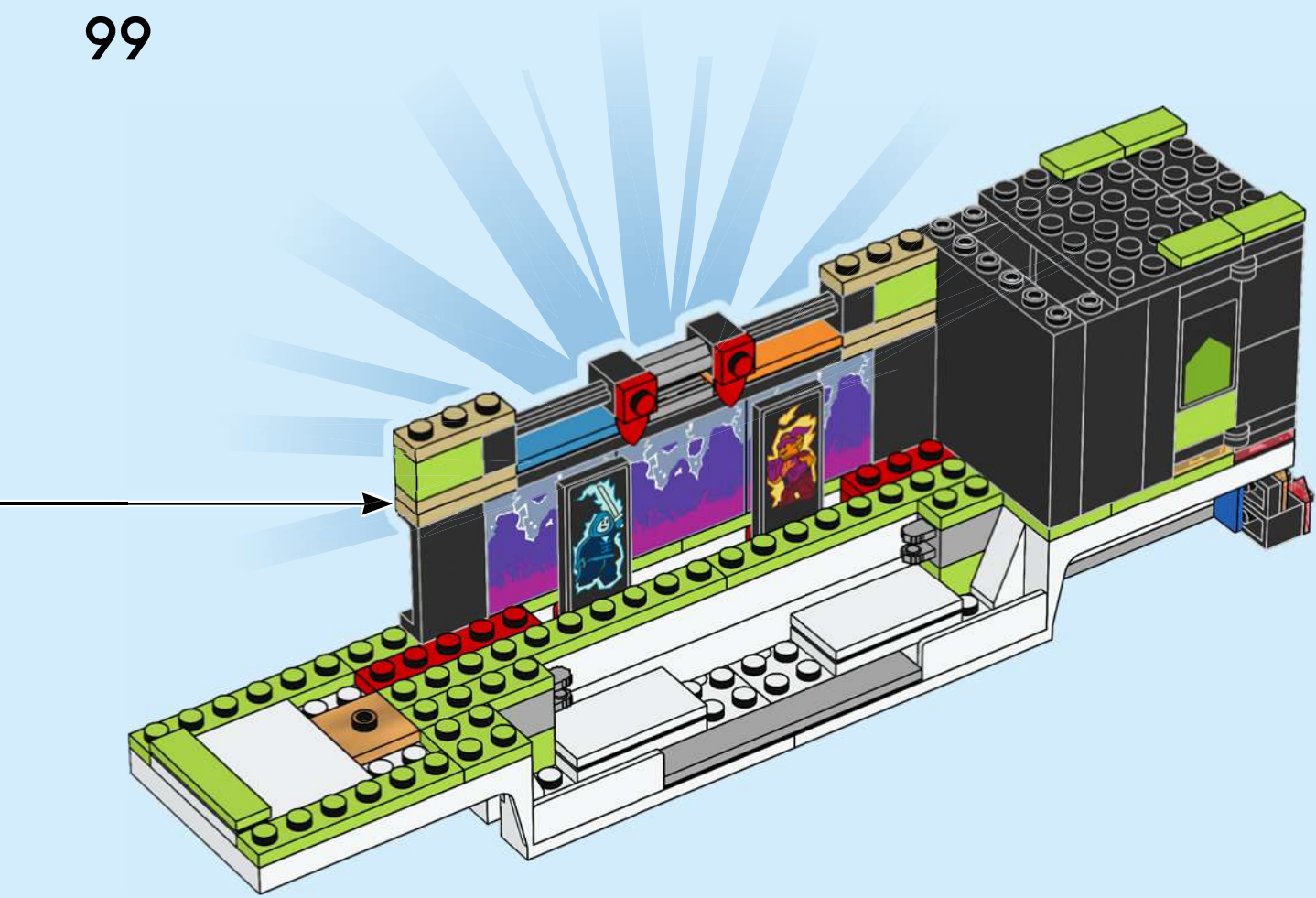

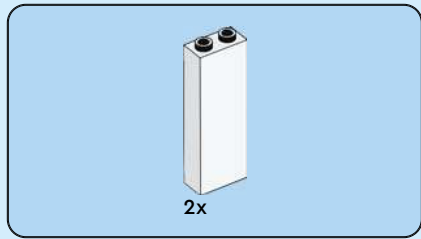

100

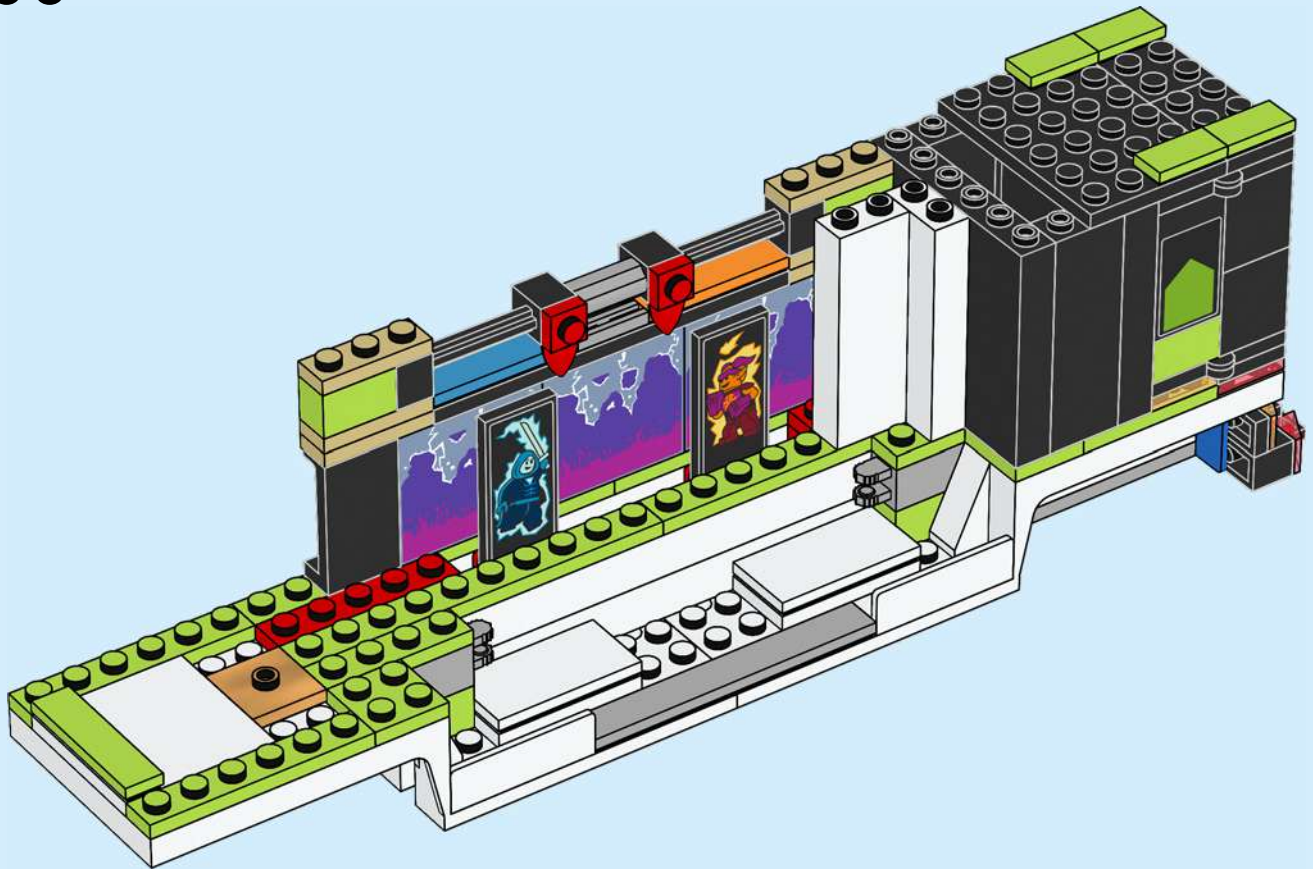

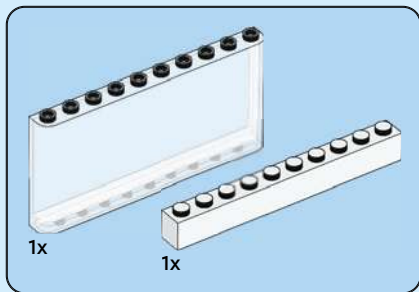

101

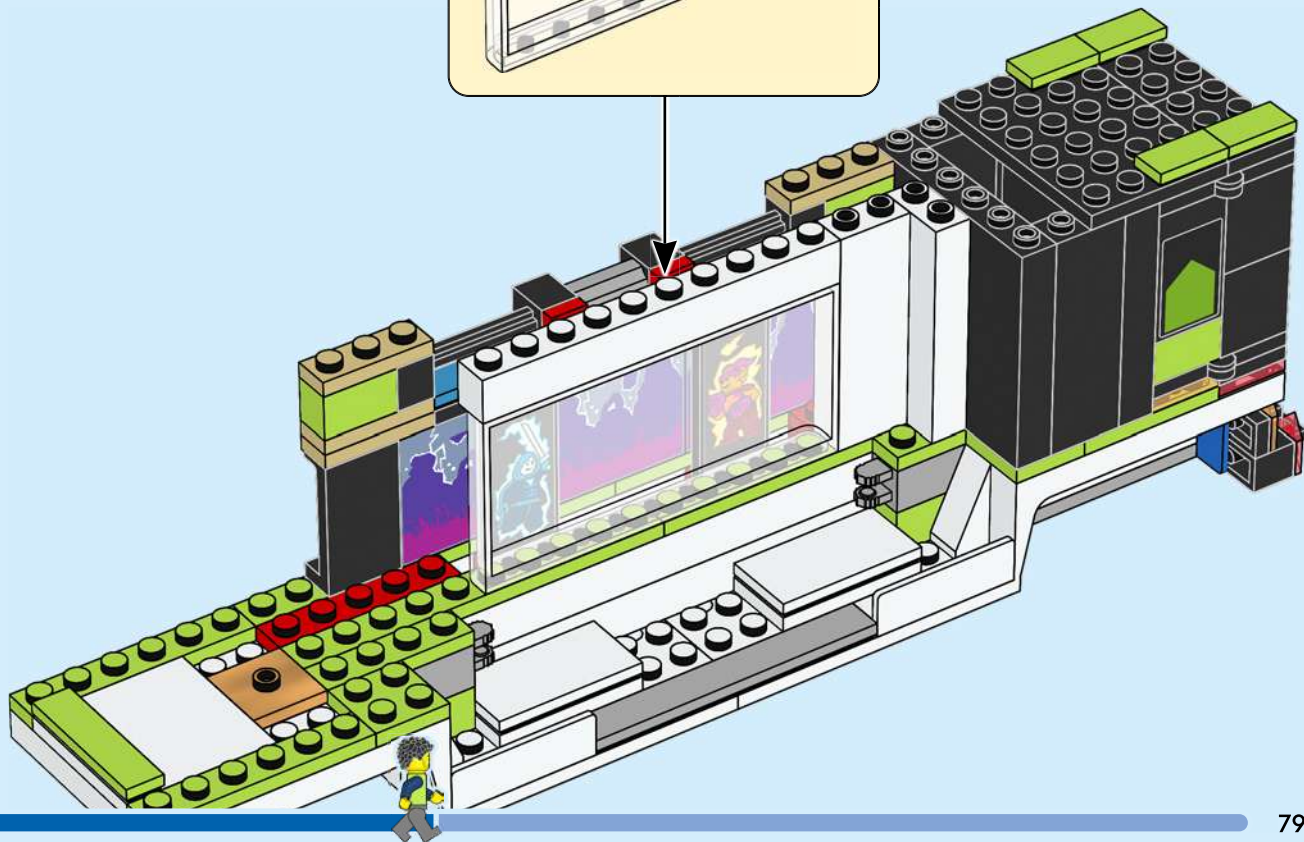
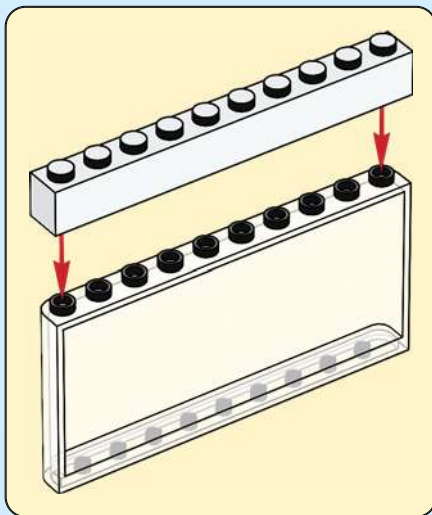

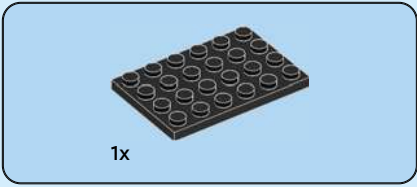

102

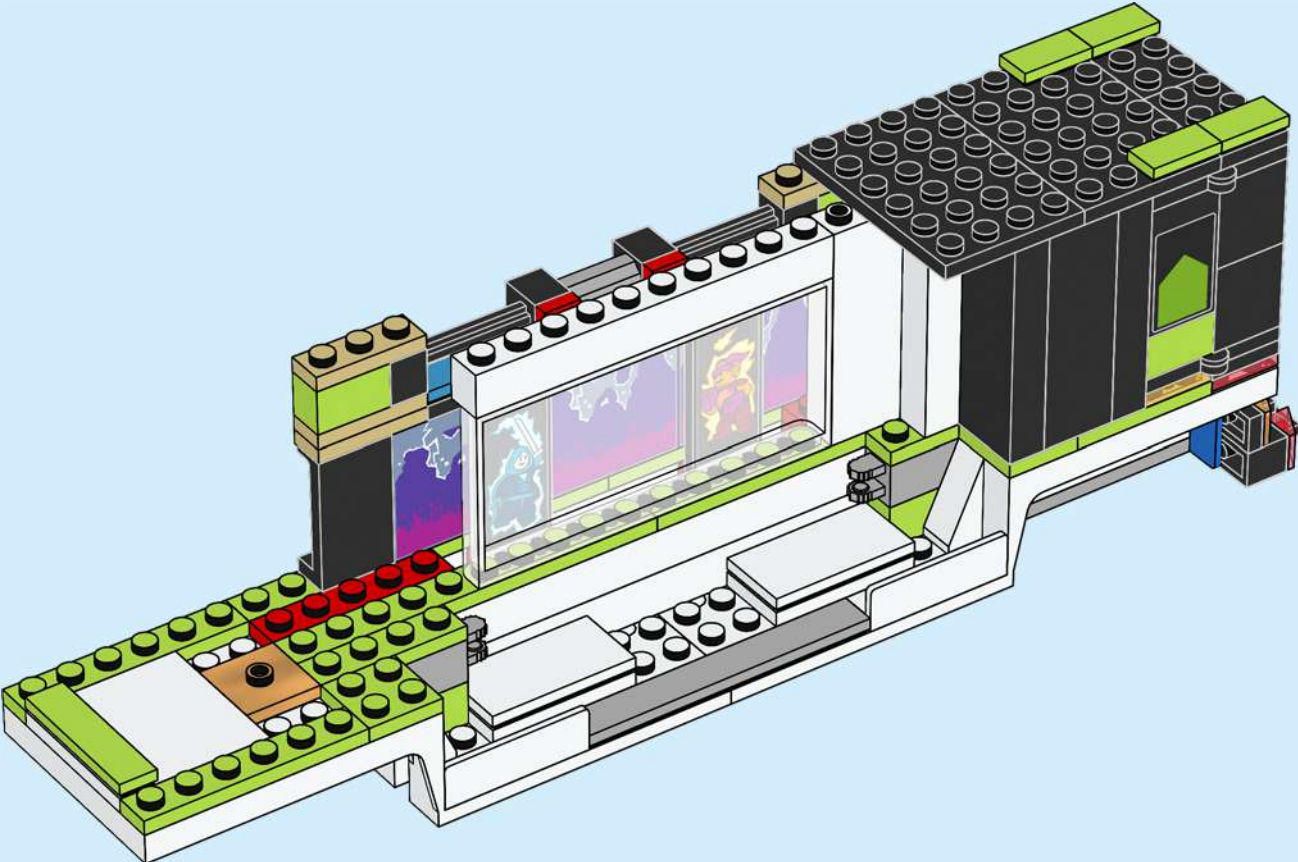

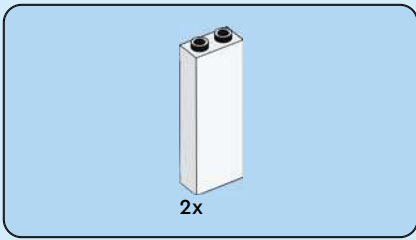

103

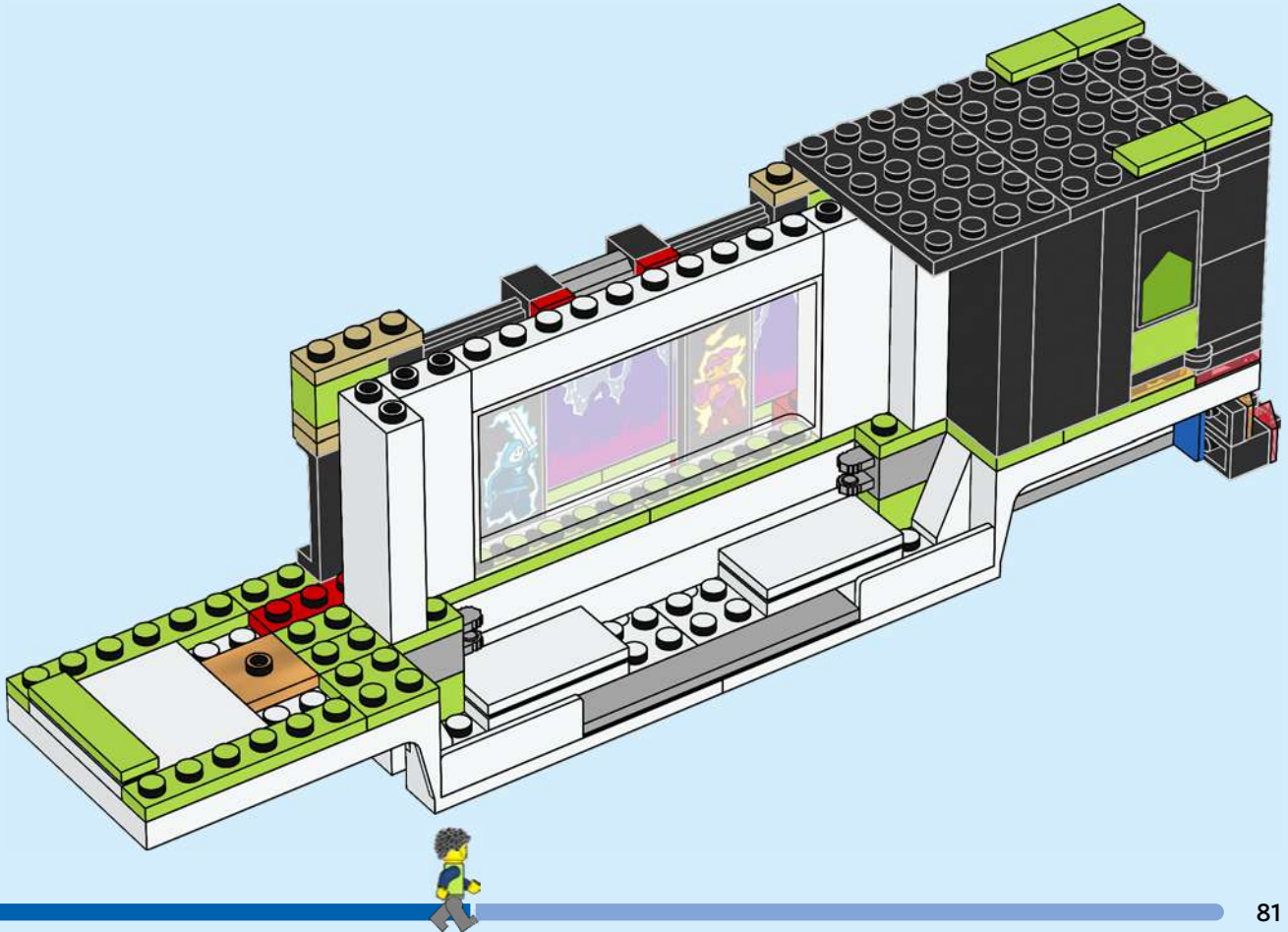

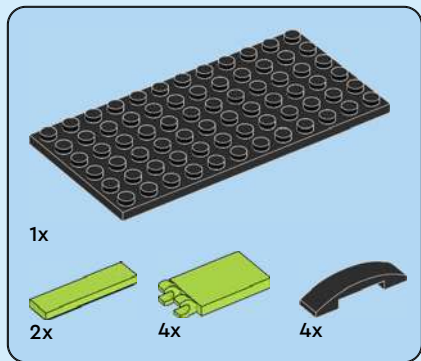

104

1

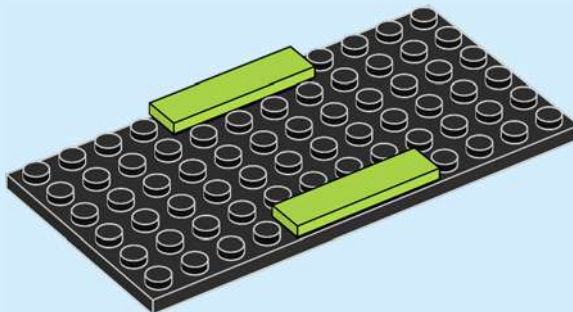

2

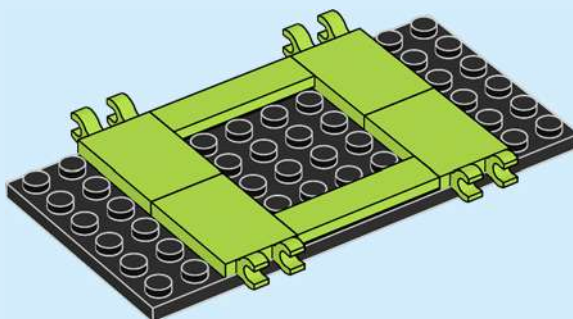

3

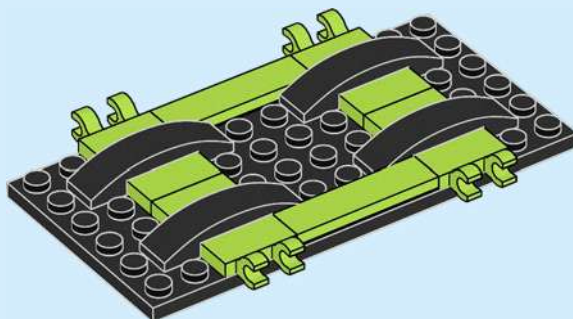

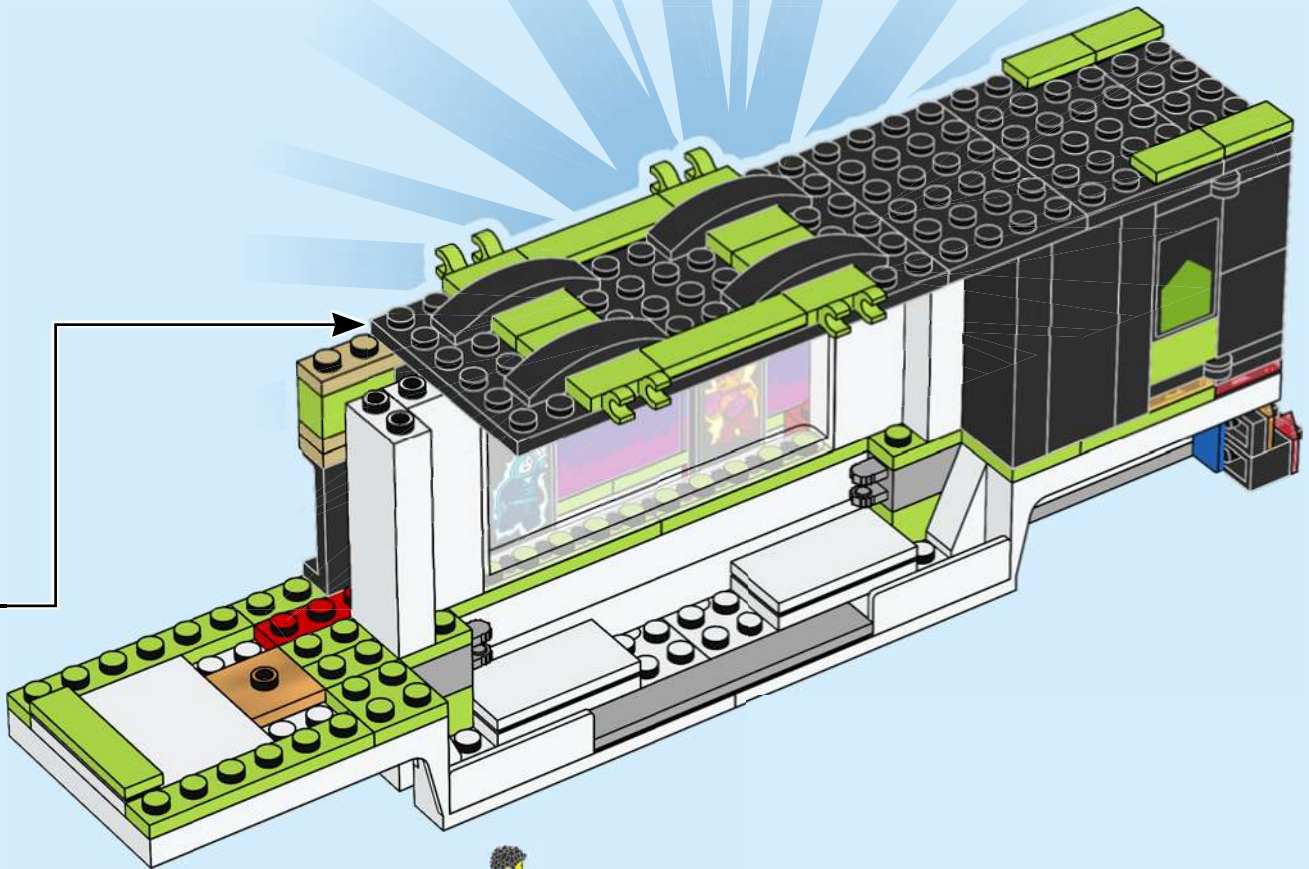

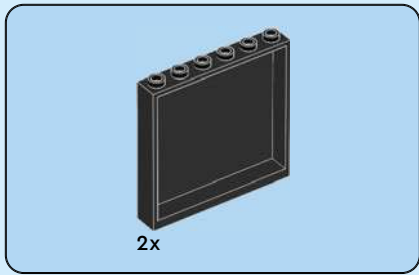

105

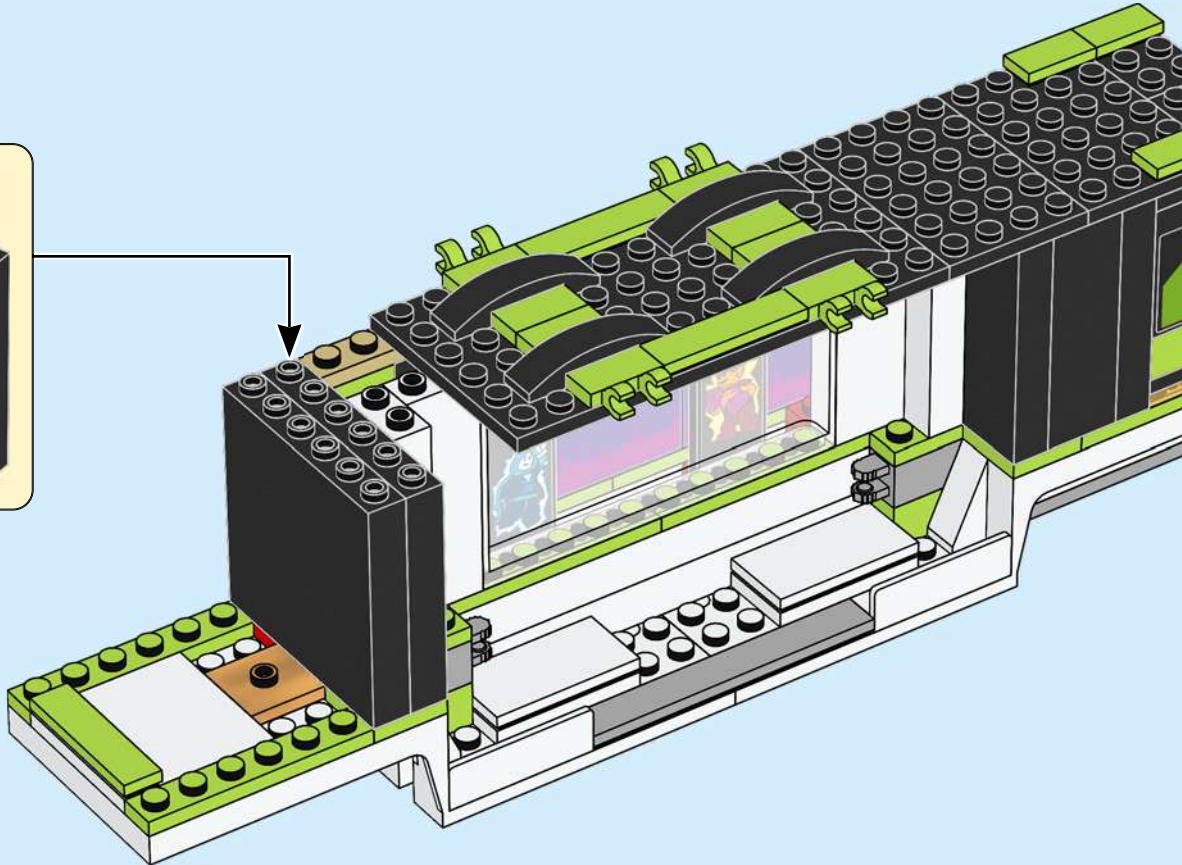
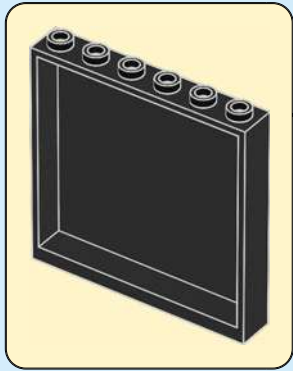

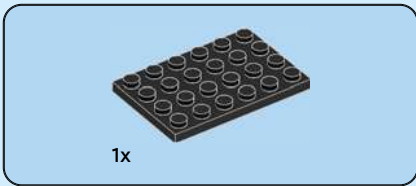

106

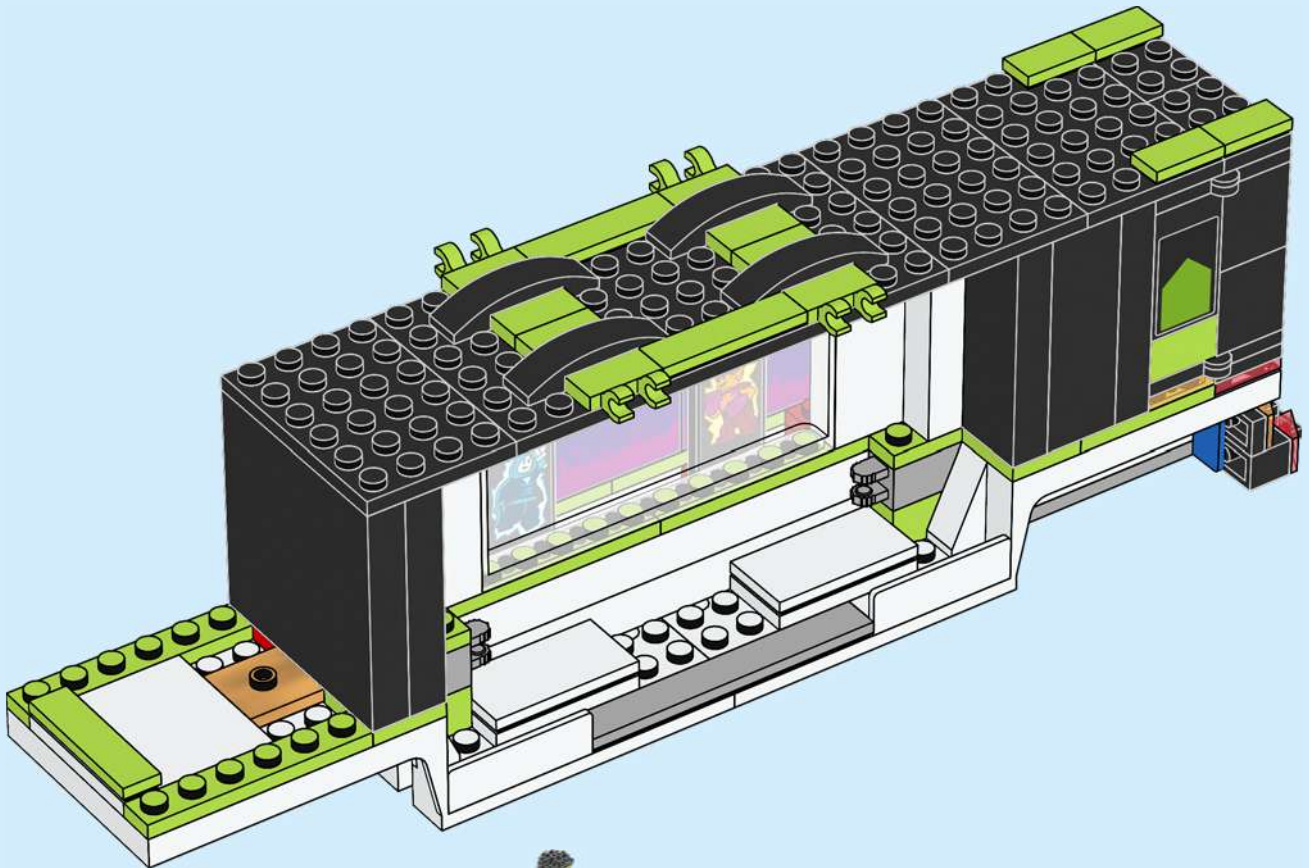

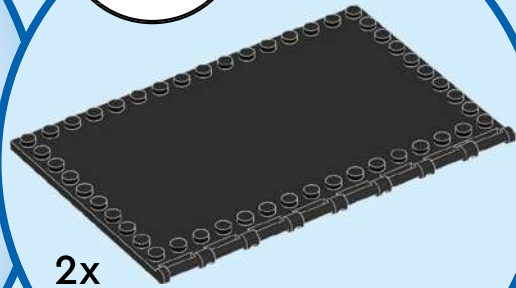
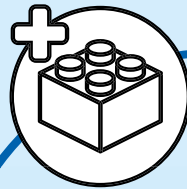



1x

107

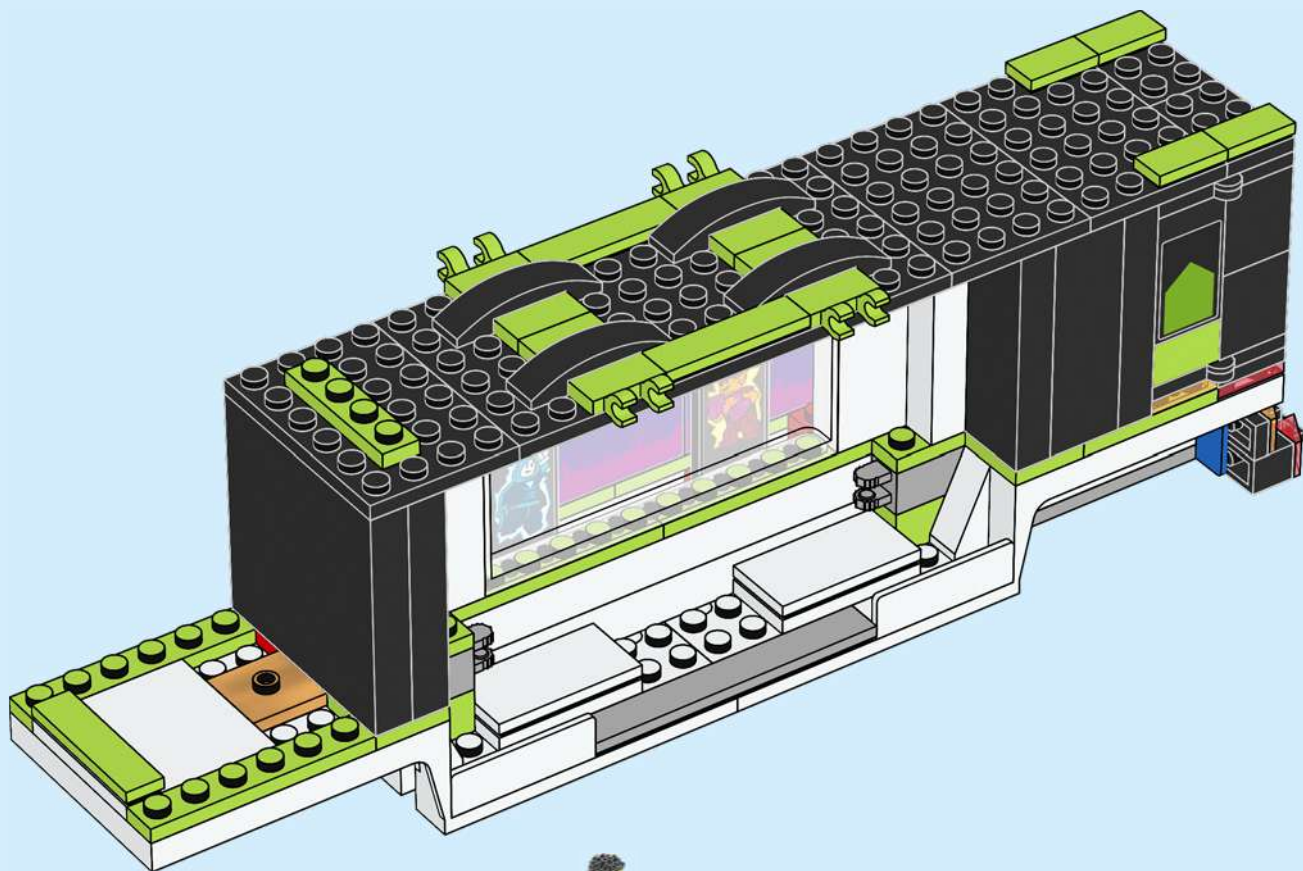



2x

108

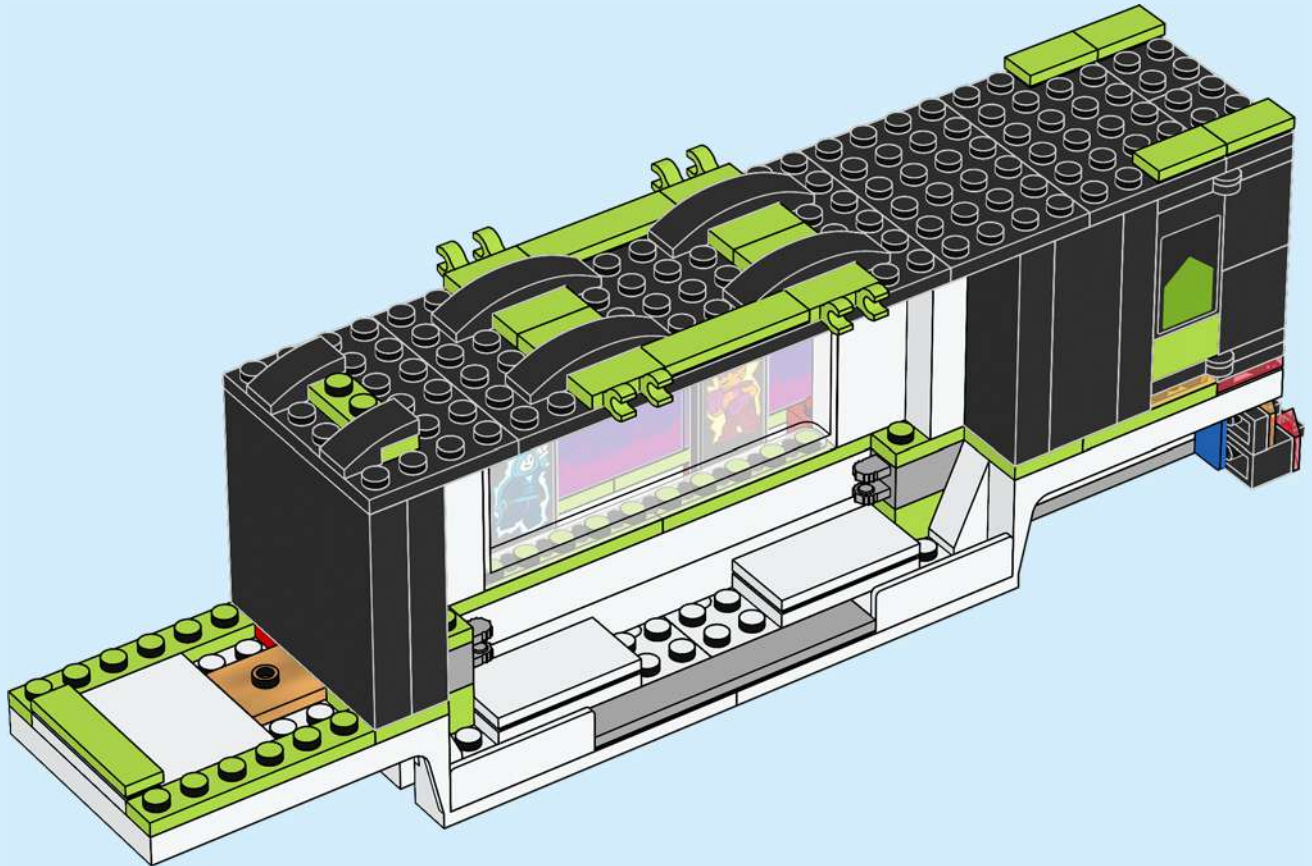

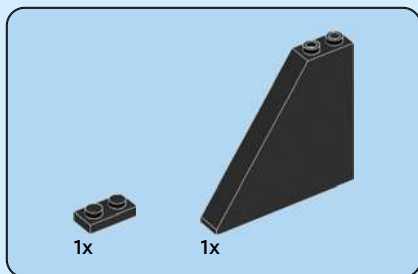

109

1

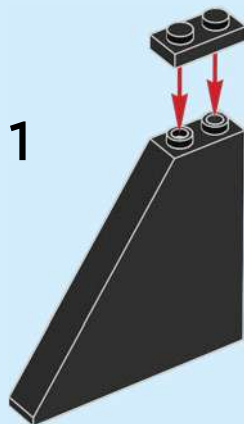

2

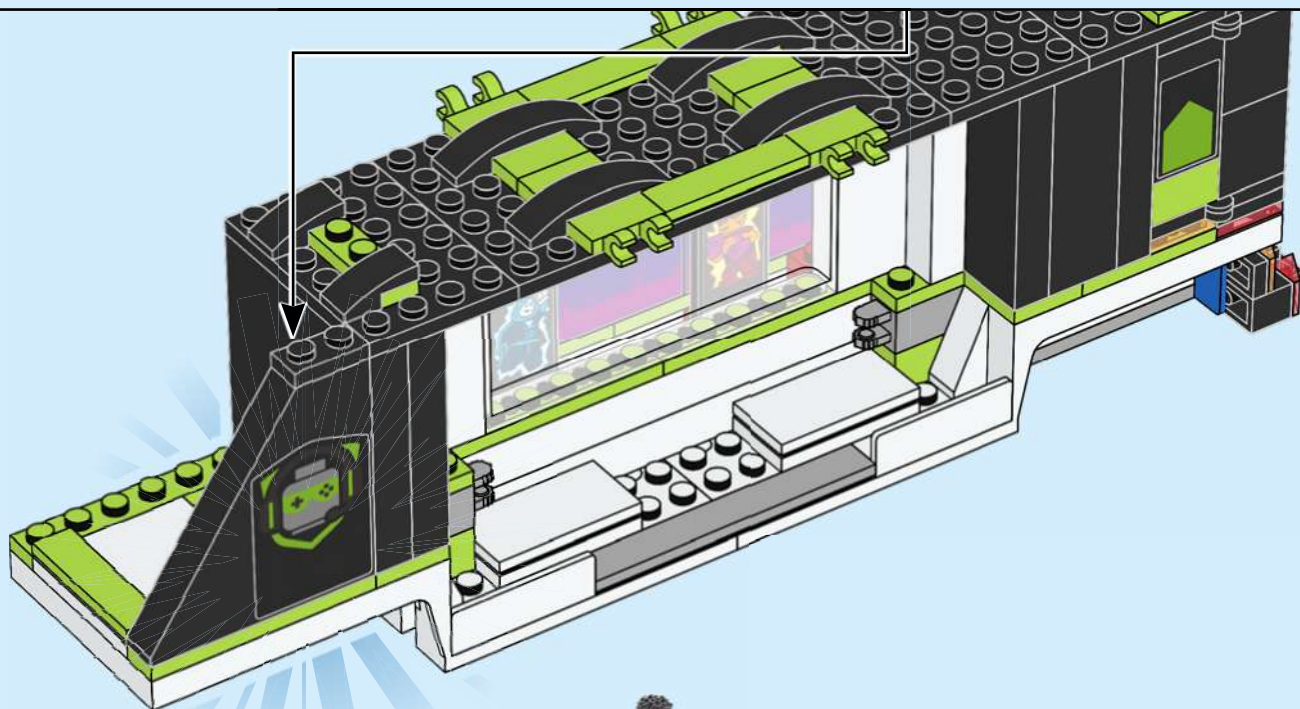
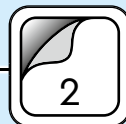
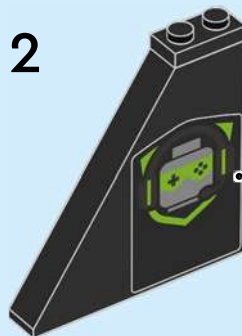

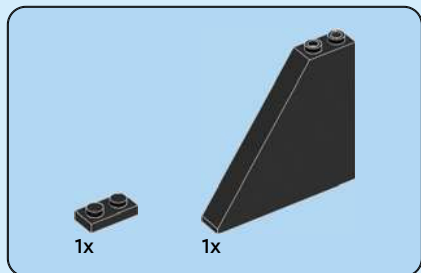

110

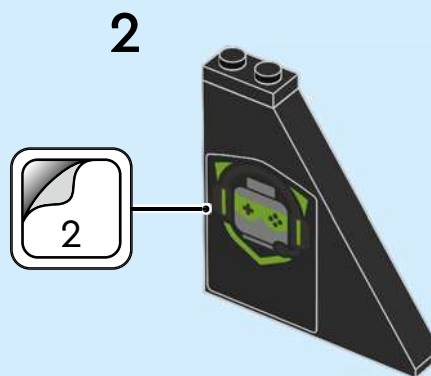
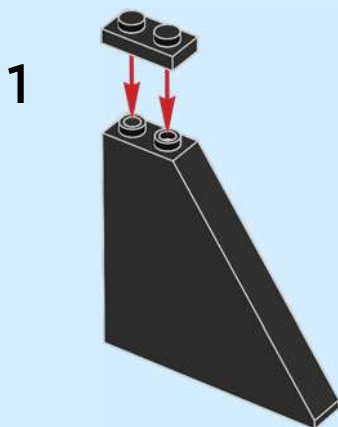

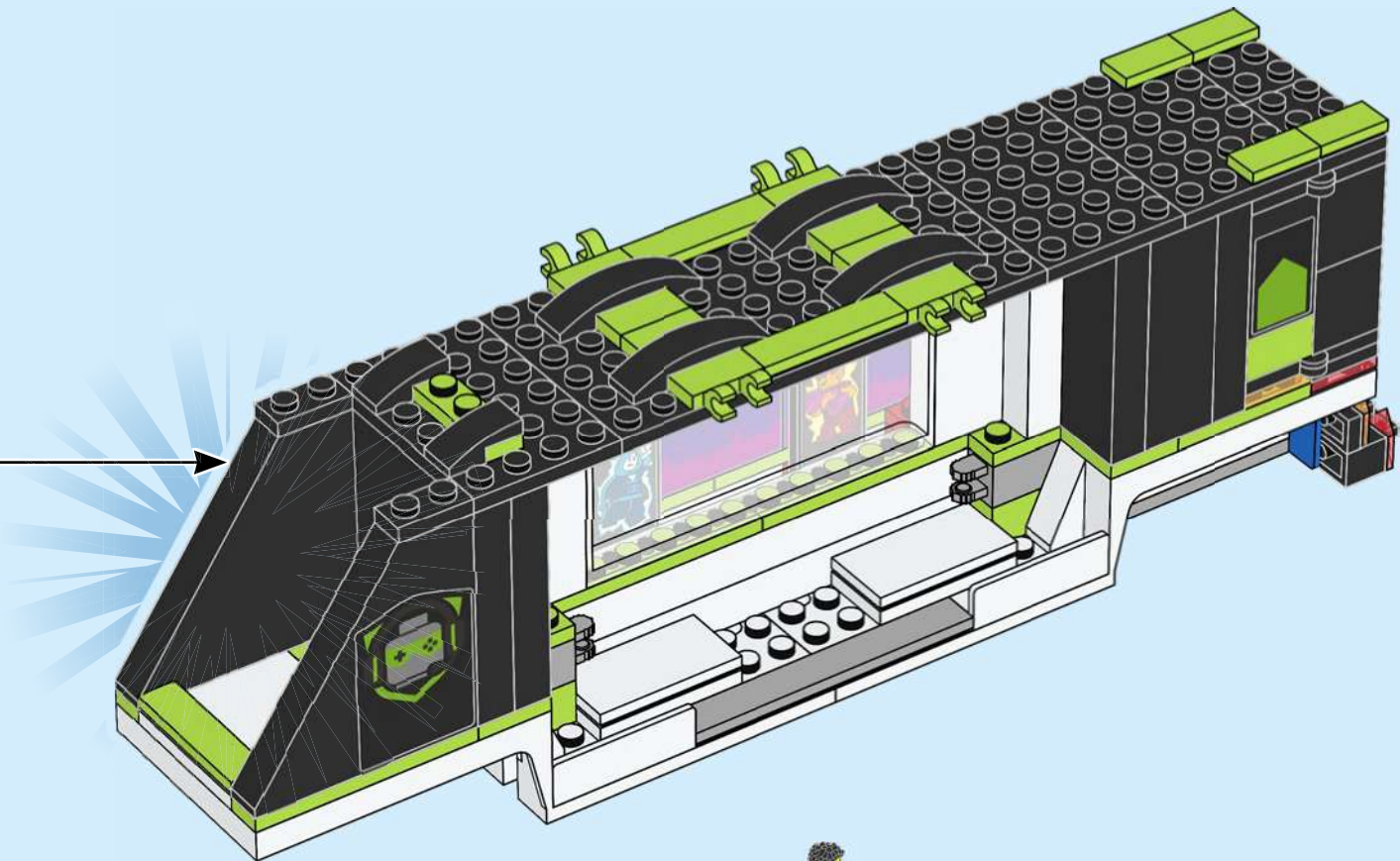

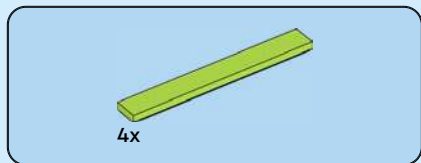

111

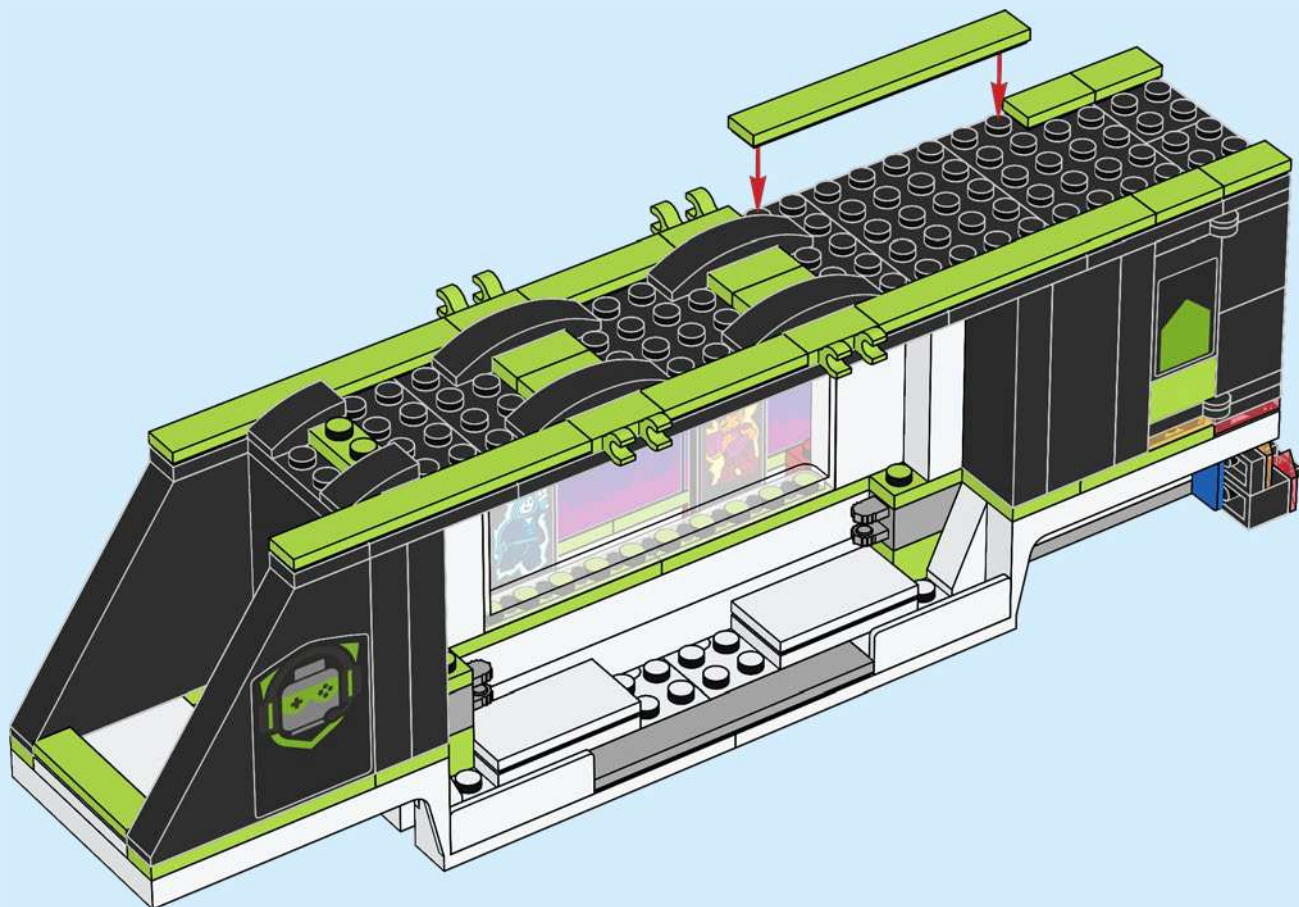

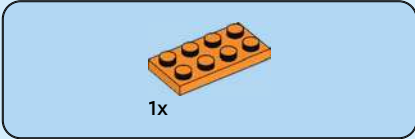

112

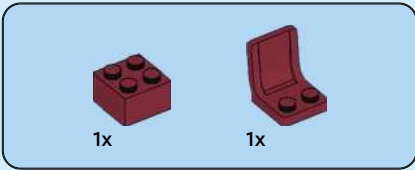

113

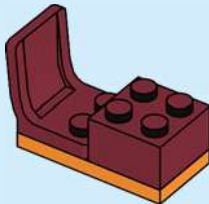

114

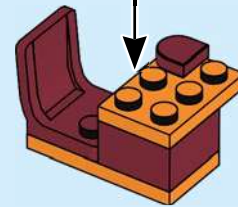
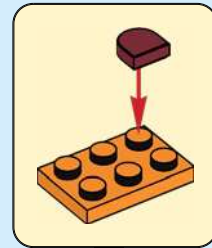

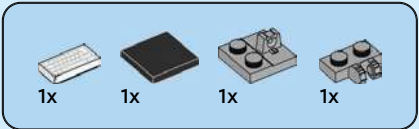

115

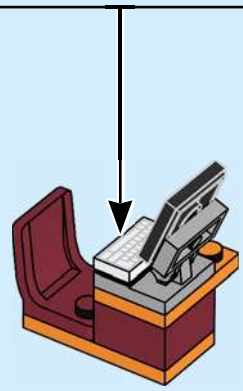
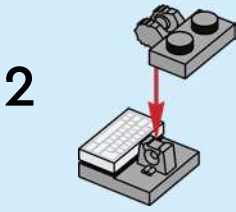
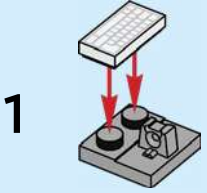

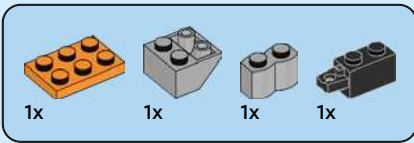

116

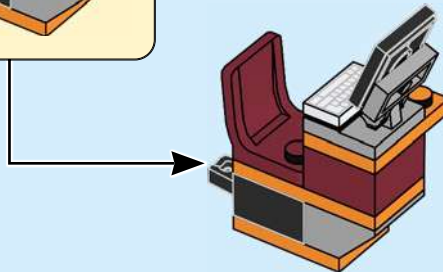
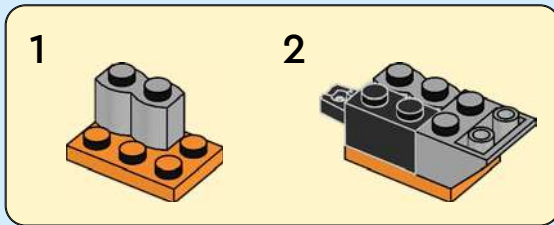

117

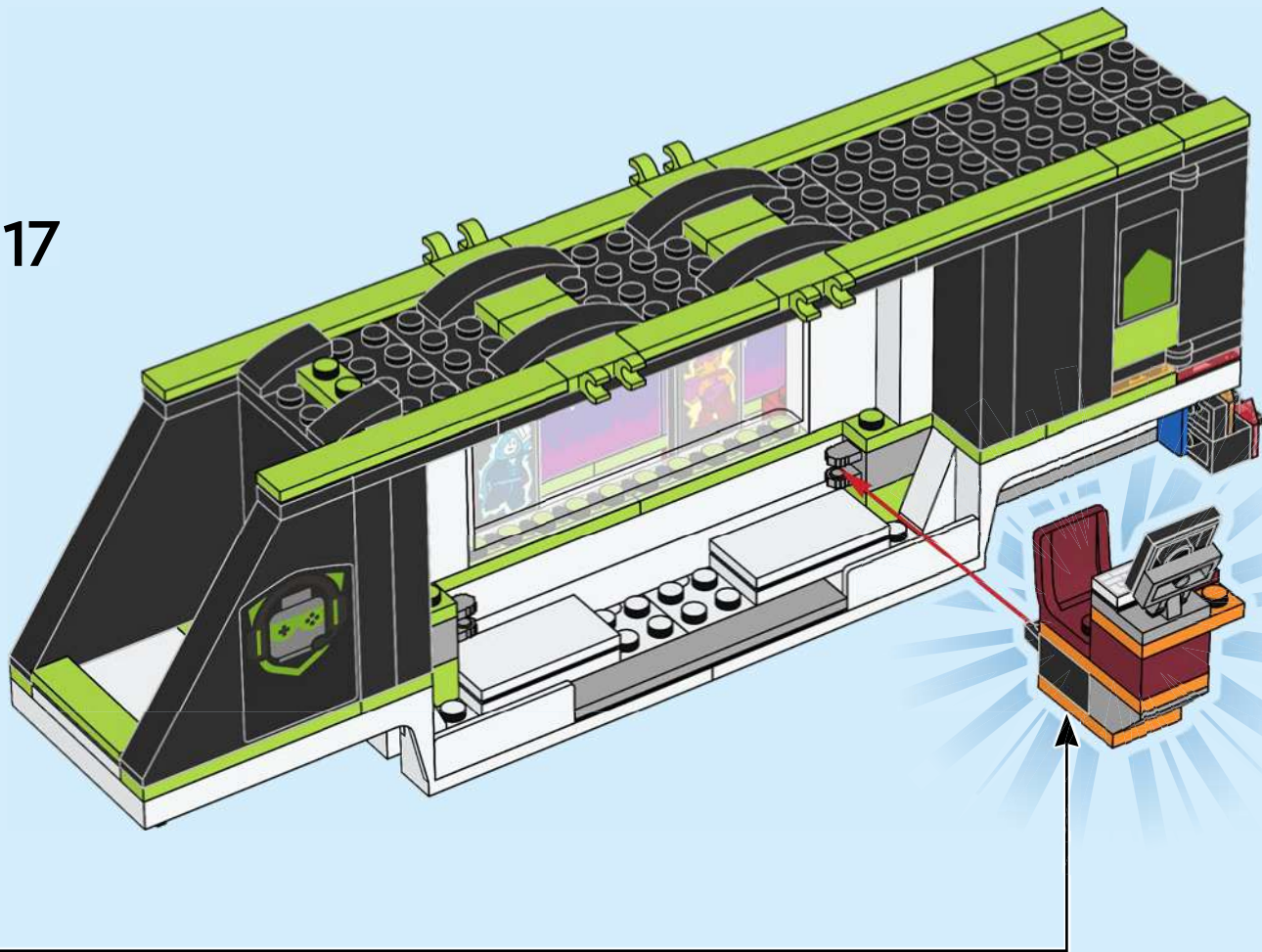

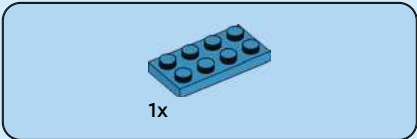

118

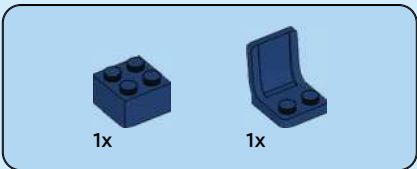
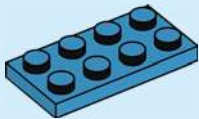

119

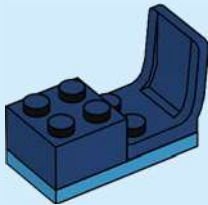

120

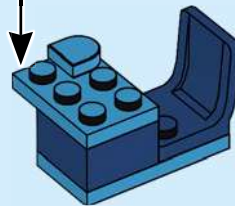
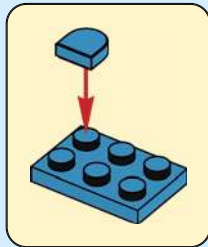

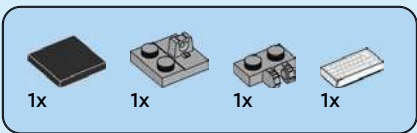

121

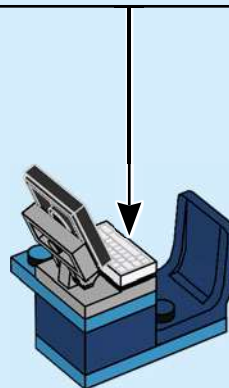
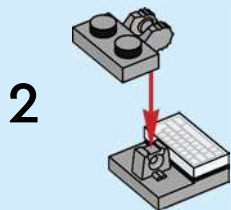
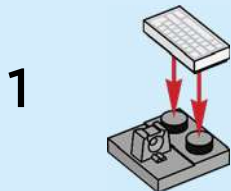

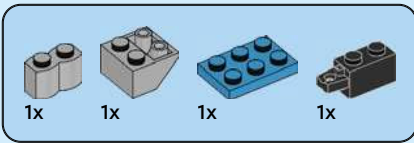

122

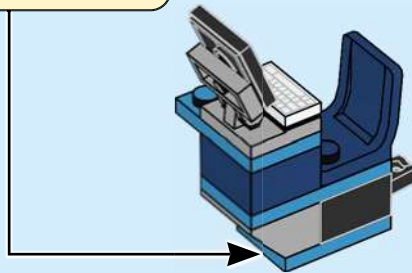
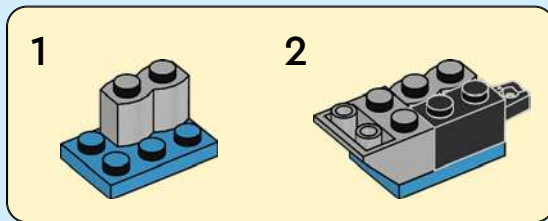

123

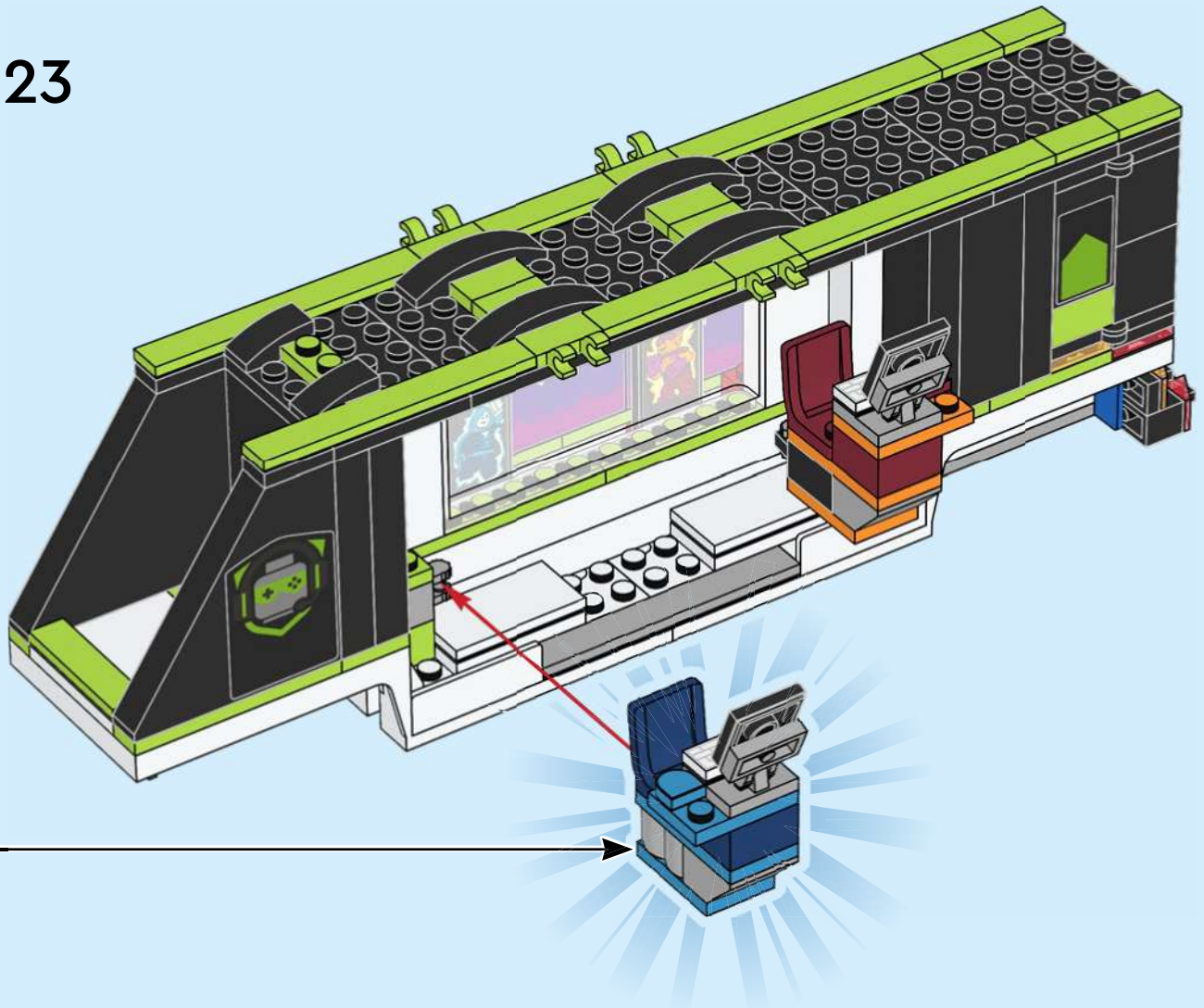

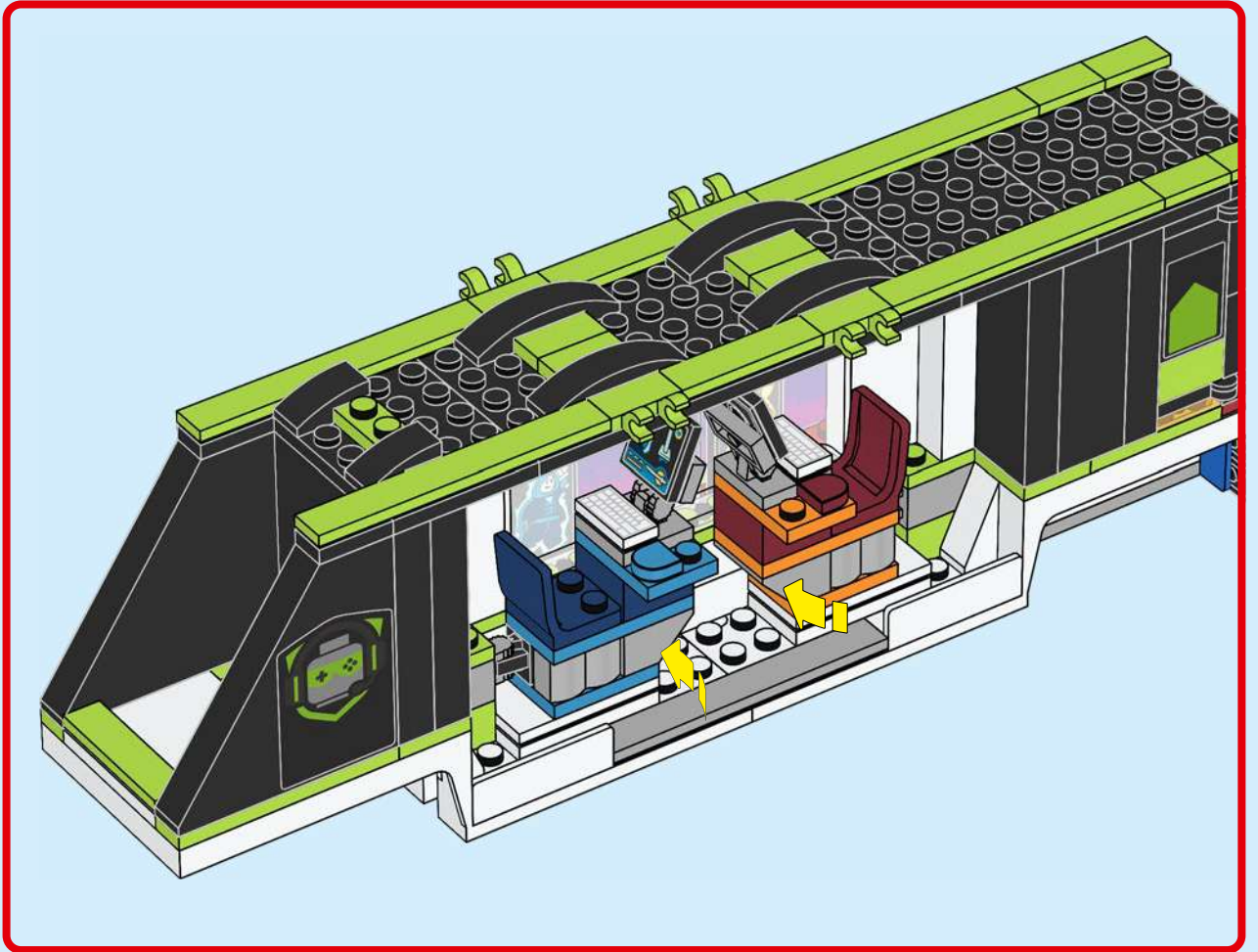

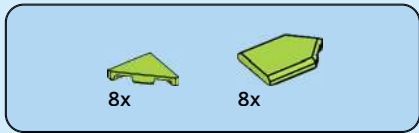
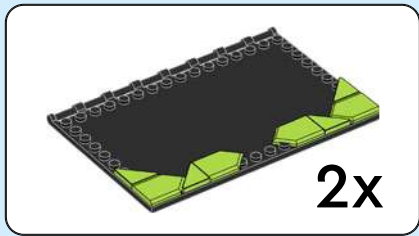

124

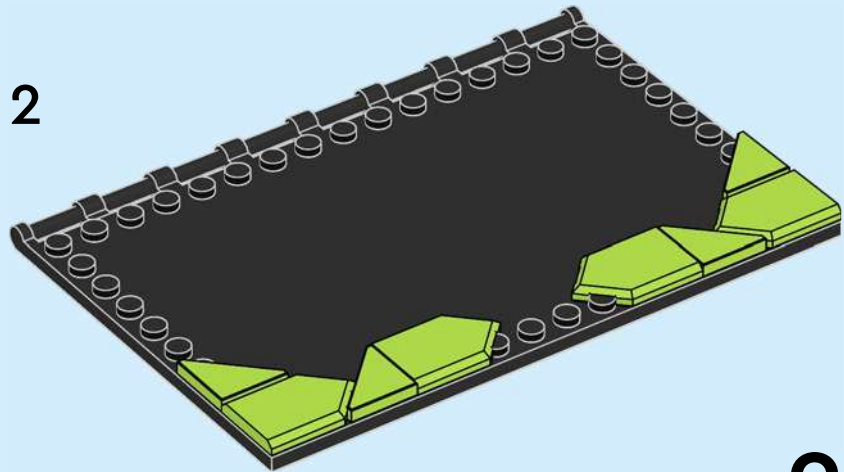
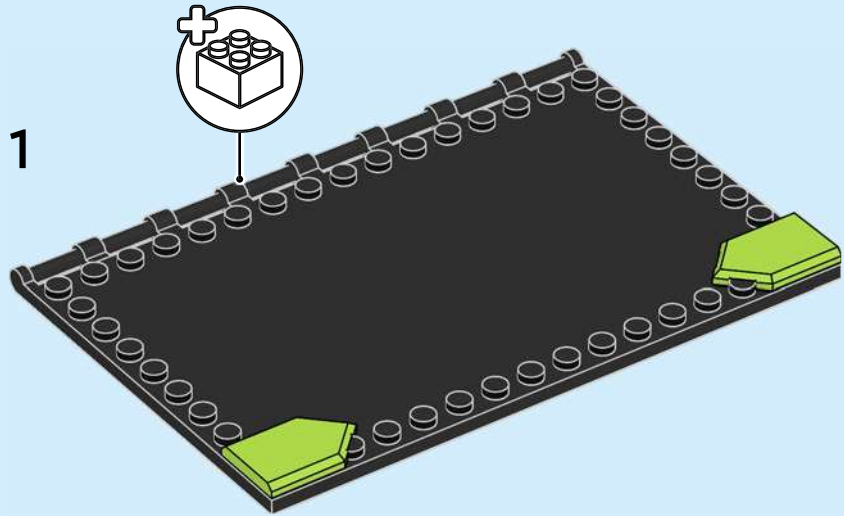

2x

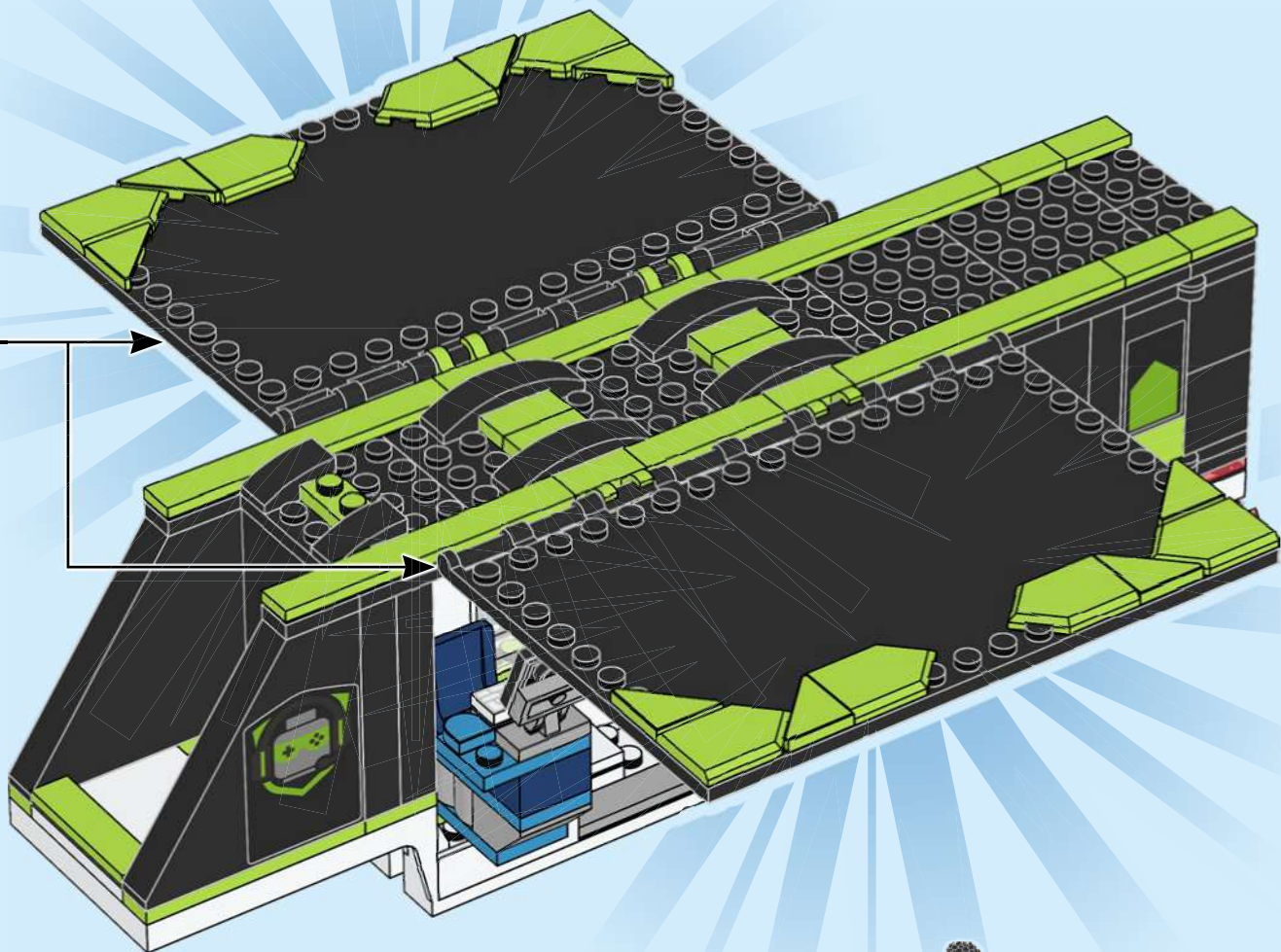

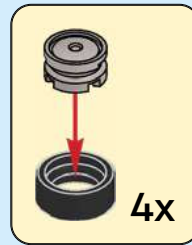
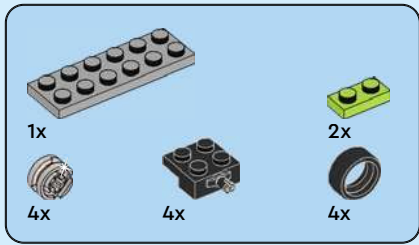

125

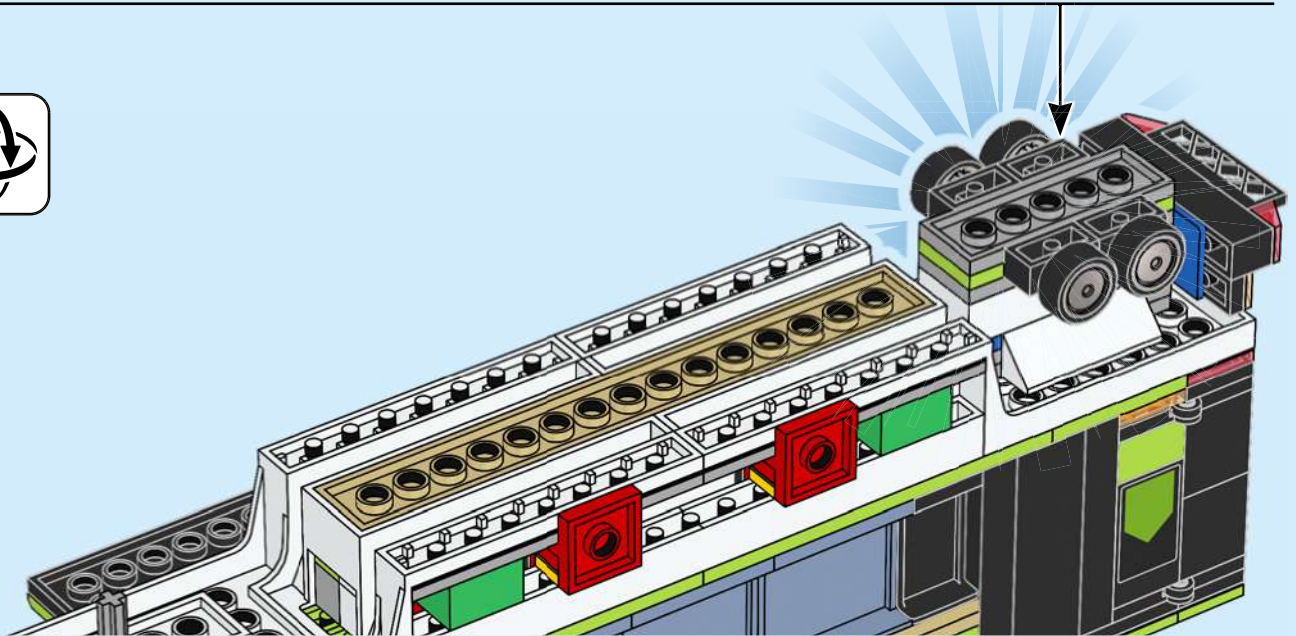
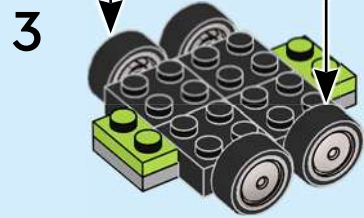
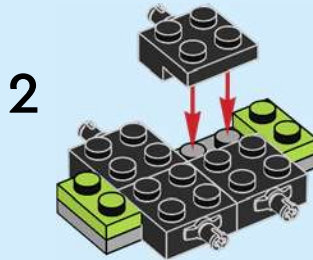
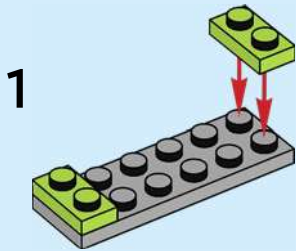



2x



2x

126

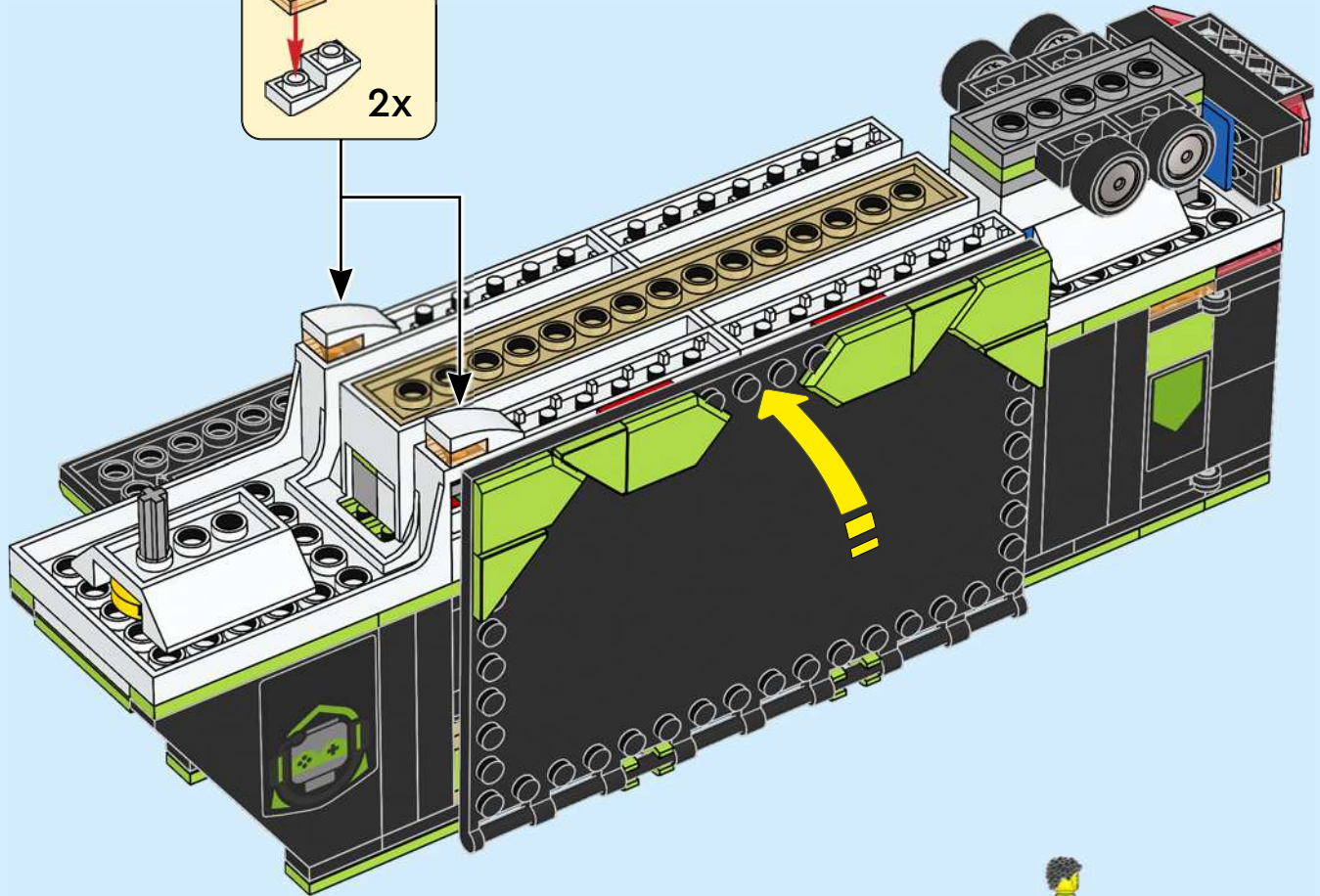
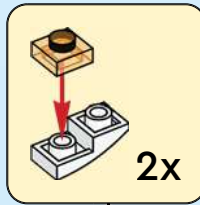



1x

127

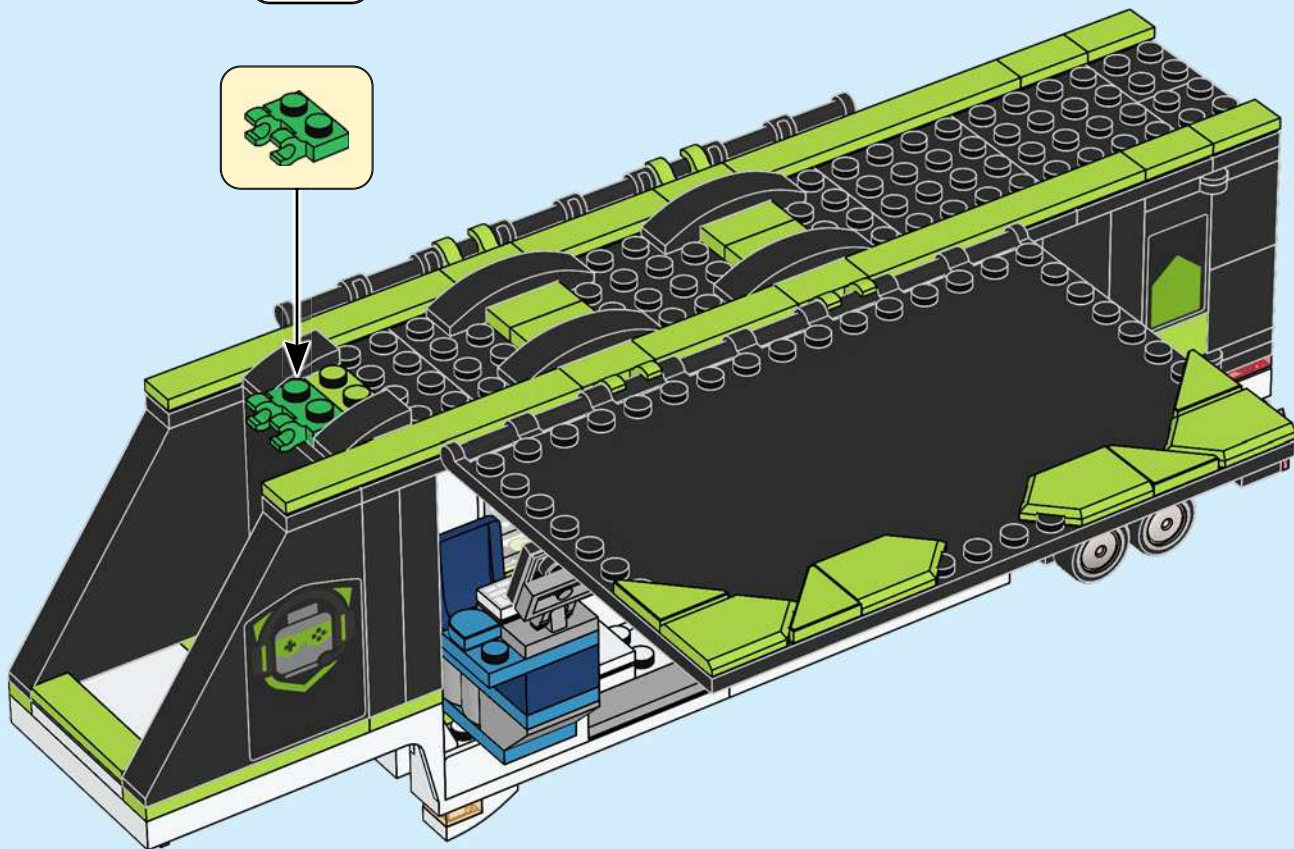

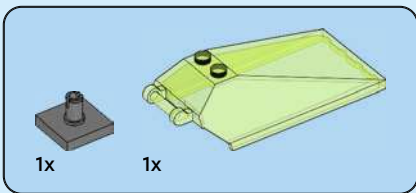

128

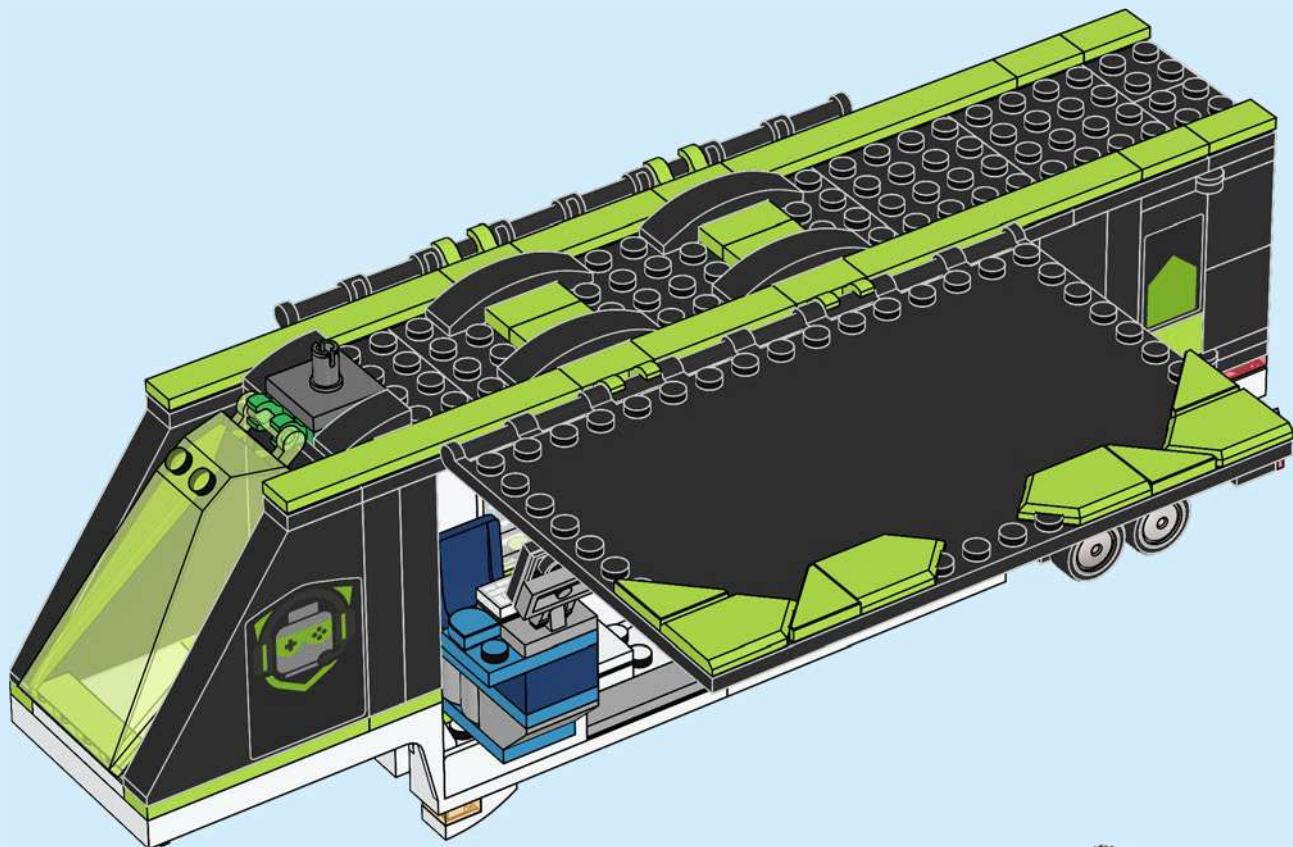

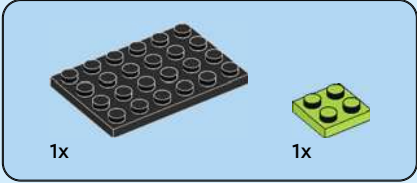

129

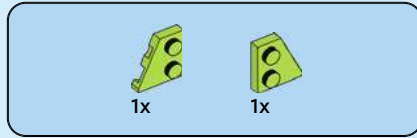
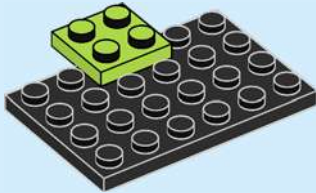

130

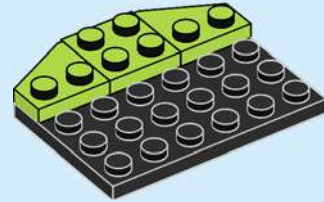

131



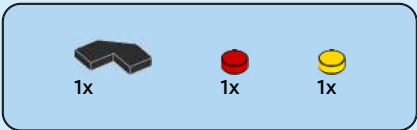

132

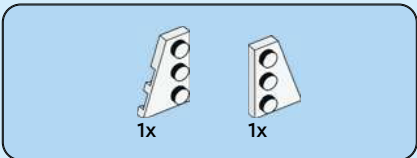
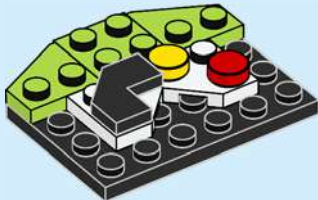

133

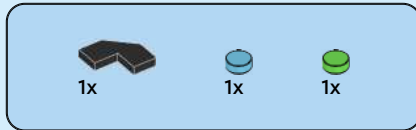

134



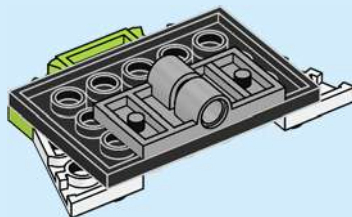
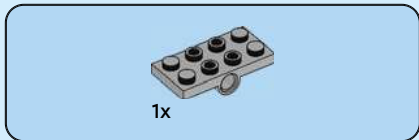

135

136

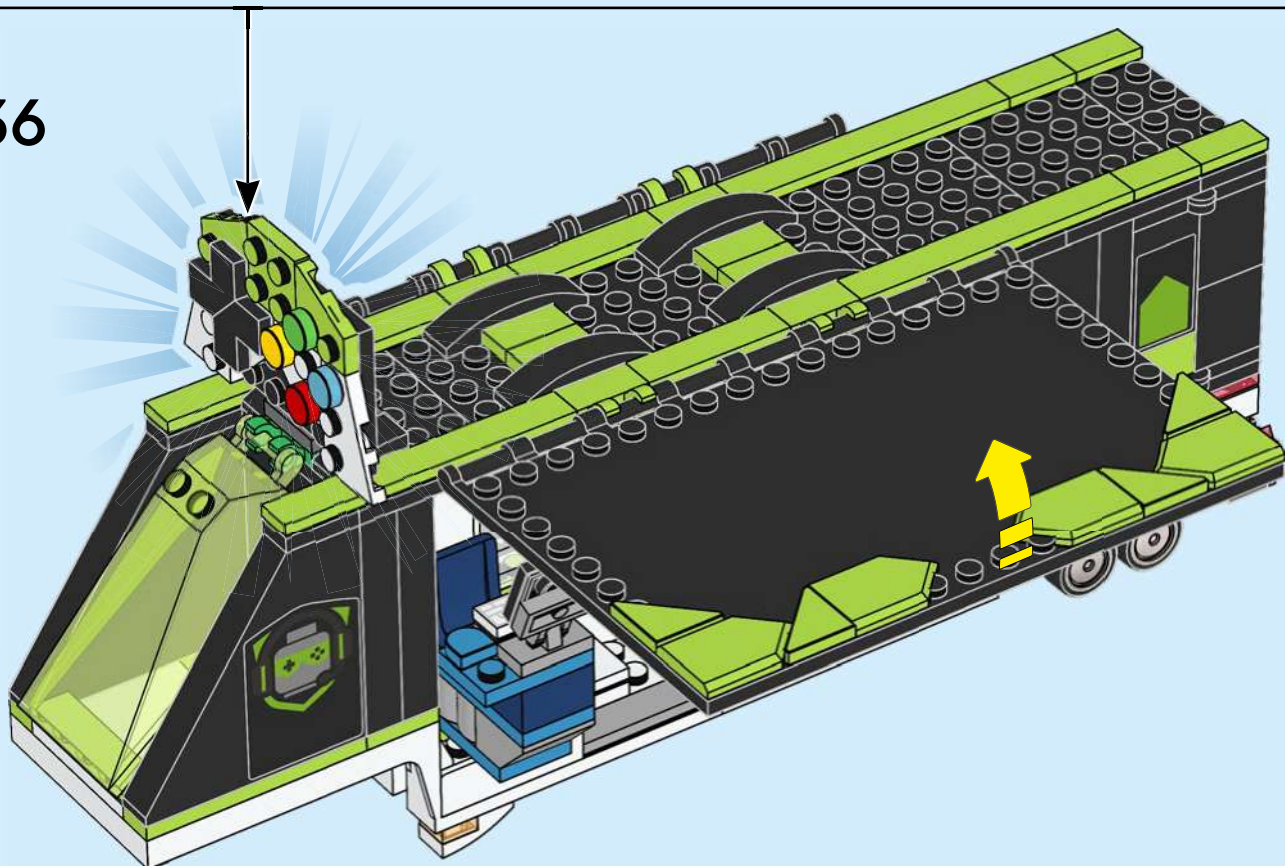

137

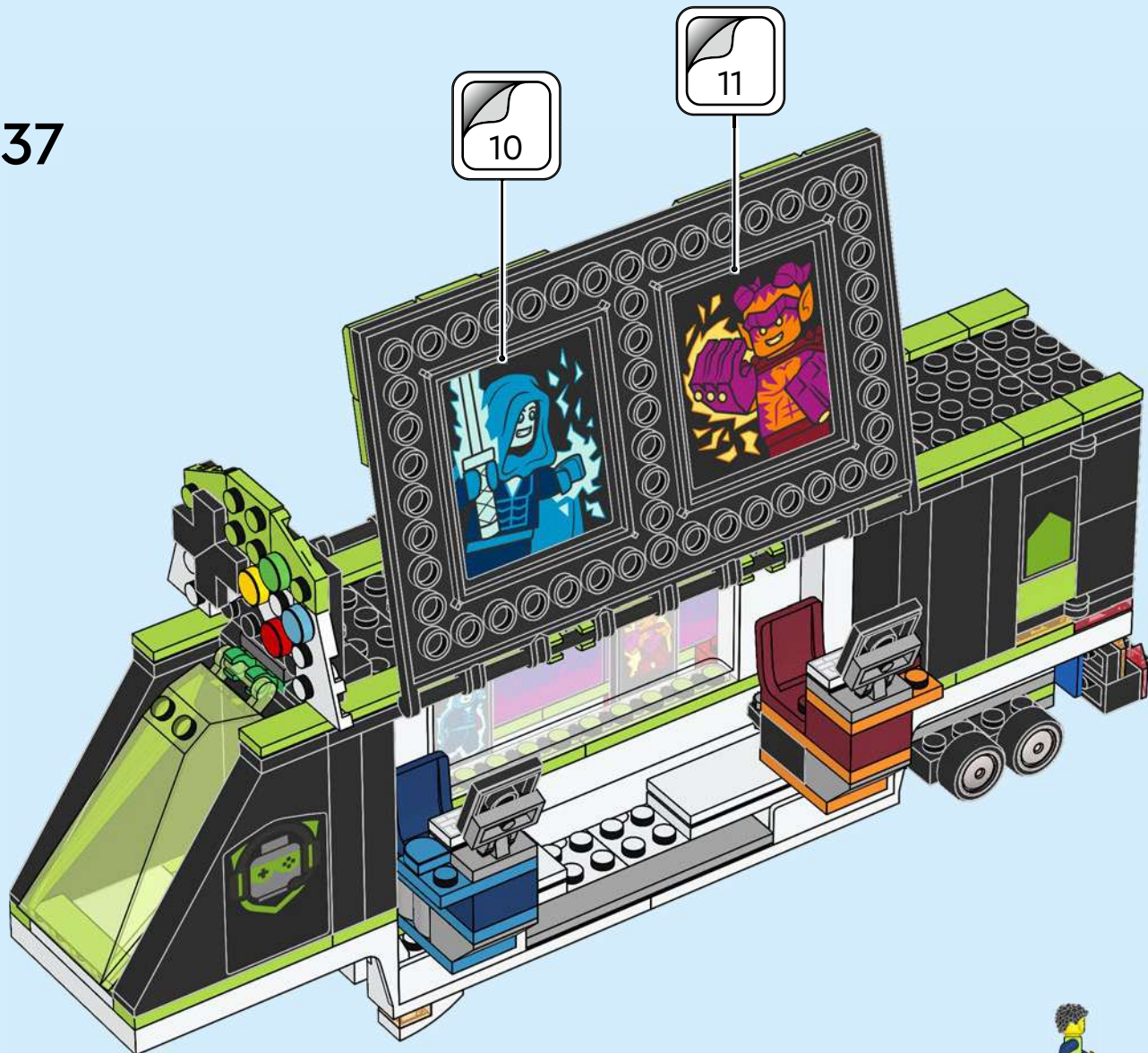

138



139

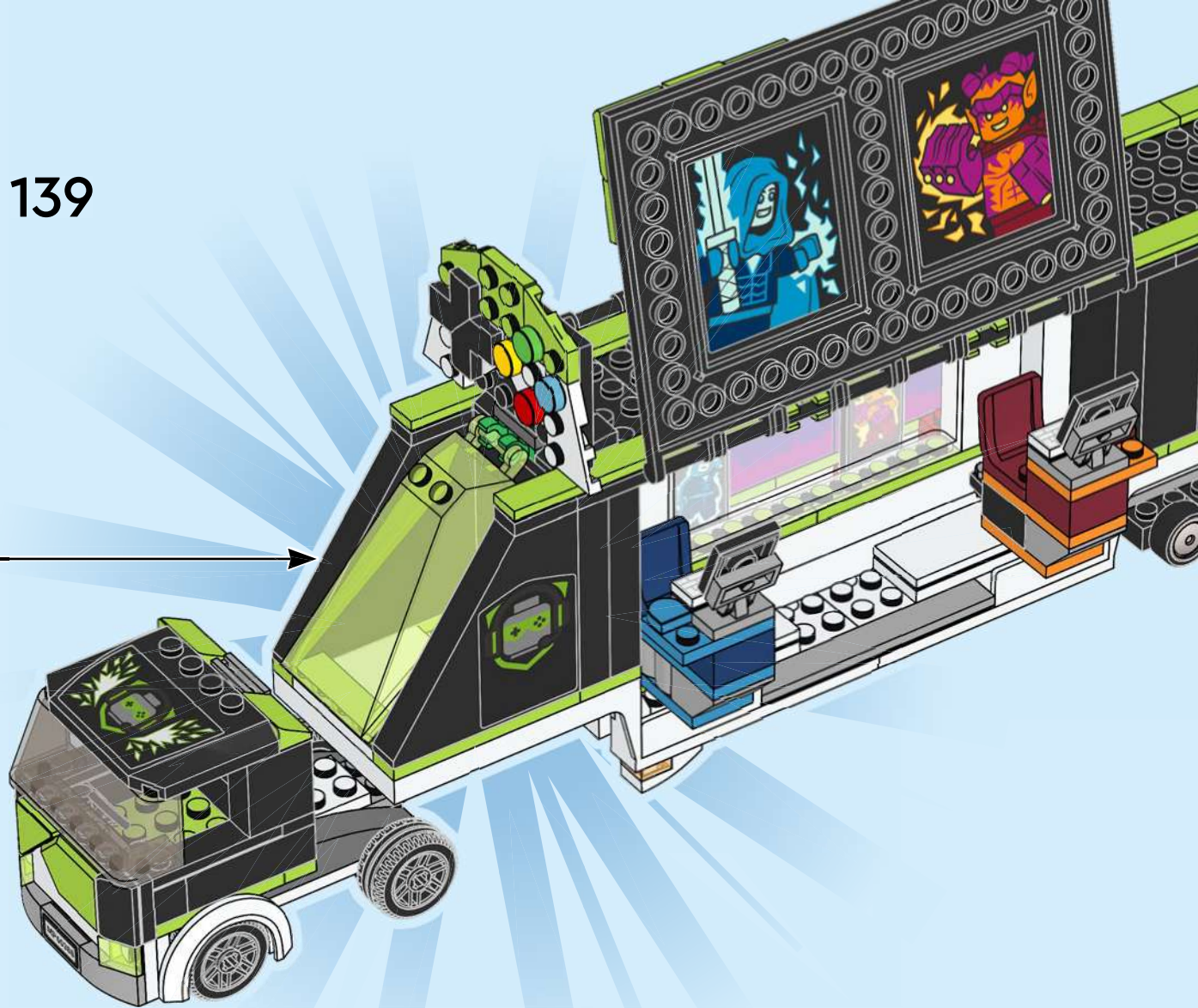



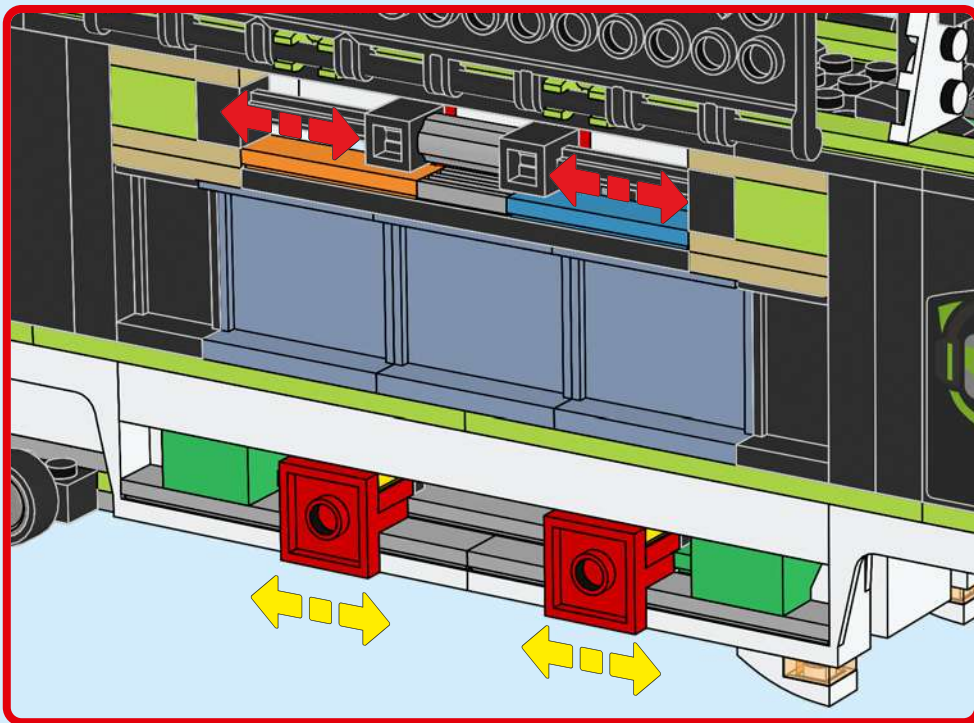
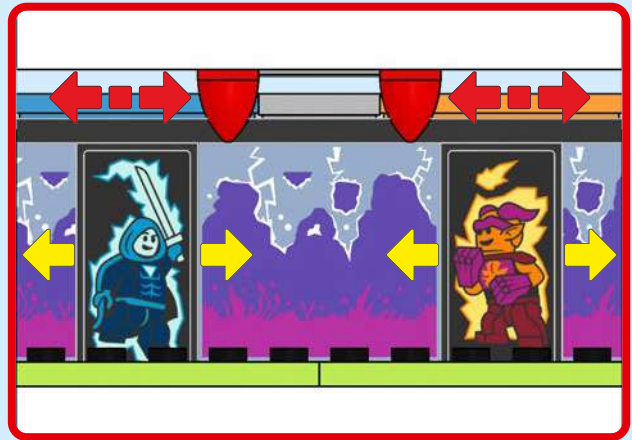



CITY



60389

60387



60383



60384



60385





CITY



60382



60371



60388



60386



60390

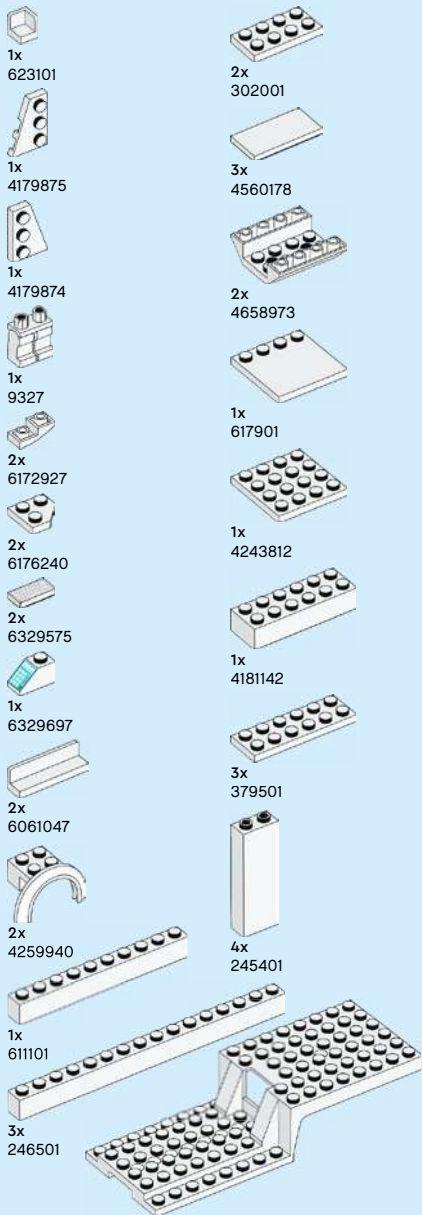

118

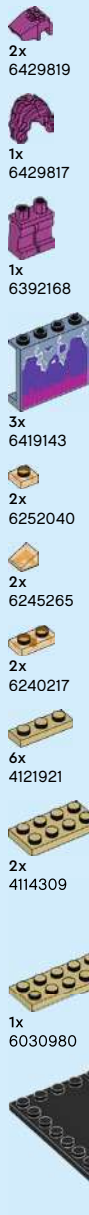
2x
64275272x
63792071x
4477261x
3028261x
6195325

YOU COULD **WIN**



Scan this QR code or go to **LEGO.COM/PRODUCTFEEDBACK** and give us your short feedback about this LEGO® set for a chance to win a cool LEGO prize.

Terms and Conditions apply*

DE: Du könntest GEWINNEN. Es gelten die Teilnahmebedingungen* **FR: Tu pourrais GAGNER.** Des conditions s'appliquent* **IT: Potresti VINCERE tu.** Termini e condizioni sono applicabili* **ES: Puedes GANAR.** Aplican términos y condiciones* **PT: Poderá GANHAR.** Aplicam-se termos e condições* **JA: プレゼント付き! 利用規約が適用されます*** **ZH: 轻松获奖. 条款和条件适用*** **KO: 상품의 주인이 되어보세요. 소정의 약관이 적용됩니다*** **RU: Вы можете ВЫИГРАТЬ.** Действуют положения и условия* **PL: Szansa na WYGRANĄ.** Obowiązują warunki korzystania* **CS: Máte šanci VYHRÁT.** Platí všeobecné smluvní podmínky* **SK: Máte šancu VYHRAŤ.** Platia všeobecné zmluvné podmienky* **HU: TE IS NYERHETSZ.** Felhasználási feltételek érvényesek* **RO: Ai putea CÂȘTIGA.** Se aplică termeni și condiții* **BG: Можете да СПЕЧЕЛИТЕ.** Има определени правила и условия* **LV: Tu vari LAIMĒT.** Ir spēkā noteikumi un nosacījumi.* **ET: Sul on võimalus VÕITA.** Kehtivad tingimused* **LT: Jūs galite LAIMĖTI.** Taikomos sąlygos*

*[LEGO.com/productfeedback-terms](https://www.lego.com/productfeedback-terms)