



DREAMZZZ

71454





FR
DONNEZ
OU
RECYCLEZ

ASSOCIATION OU MAGASIN OU DÉCHÈTERIE

Adresses sur quefairedemesdechets.fr



LEGO.com/sustainable-packaging



BUILDER



Apple and the Apple logo are trademarks of Apple Inc., registered in the U.S. and other countries and regions. App Store is a service mark of Apple Inc. Google Play and the Google Play logo are trademarks of Google LLC. Tencent and the Tencent logo are trademarks of Tencent Inc.

Q [LEGO.com/devicecheck](https://www.lego.com/devicecheck)

EN Ask parents' permission before going online | **DE** Eltern um Erlaubnis bitten, bevor du online gehst | **FR** Demande l'autorisation d'un parent avant d'aller en ligne | **IT** Chiedi il permesso ai tuoi genitori prima di andare online | **ES** Pídeles permiso a tus papás antes de conectarte a Internet | **PT** Peça autorização aos pais antes de acederes online | **ZH** 上网前应先征得父母的同意 | **PL** Poproś rodziców o zgodę, zanim wejdiesz do Internetu | **CS** Než půjdeš na internet, požádej rodiče o svolení | **SK** Skôr než pôjdeš na internet, vypýtaj si povolenie od rodičov | **HU** Kérj szülői engedélyt, mielőtt online csatlakoznál! | **RO** Cere permisiunea părinților înainte de a te conecta online | **BG** Поискайте разрешение от родител, преди да влезете онлайн | **LV** Pirms došanās tiešsaistē palūdz atļauju vecākiem | **ET** Enne Interneti kasutamist küsi vanematelt luba | **LT** Prieš prisijungdami prie interneto, atsiklauskite tėvų





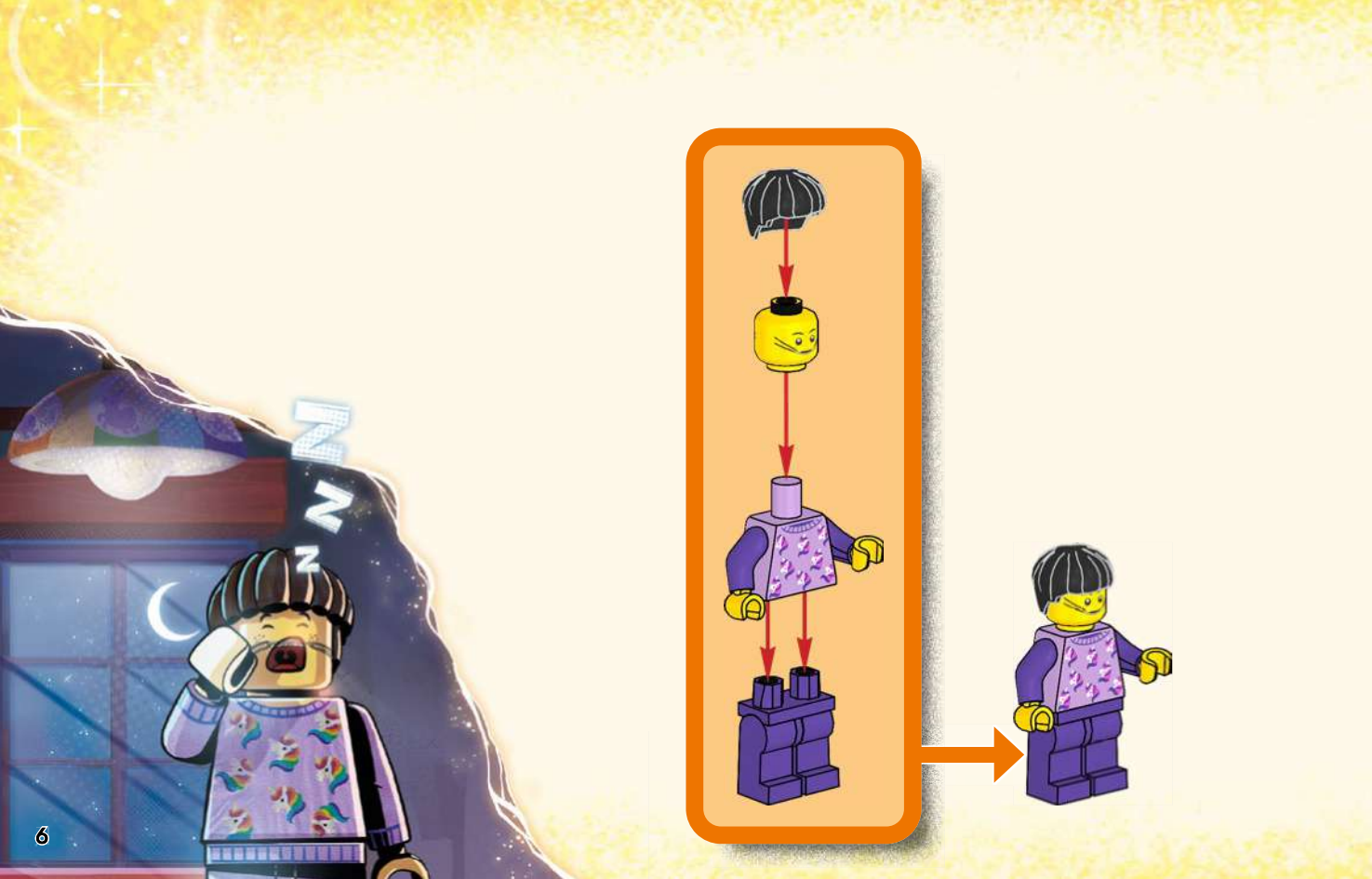



1

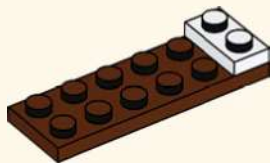

1x

2





1x



1x

3

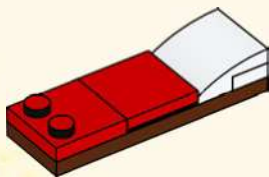

8

4







1x



1x

1





1x

2



1x

3





4x

4



1x

5





2x

6

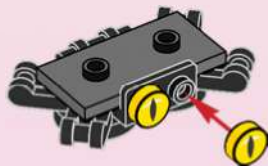

4x



4x

7

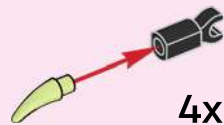



8

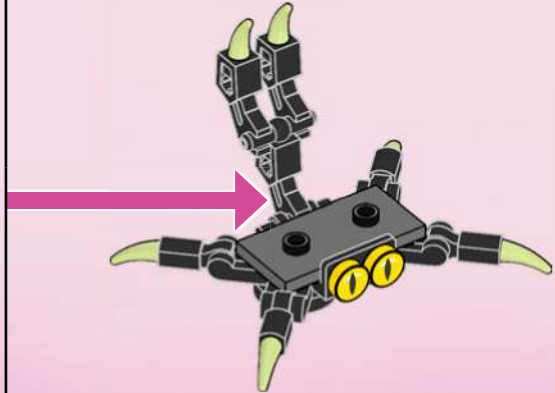
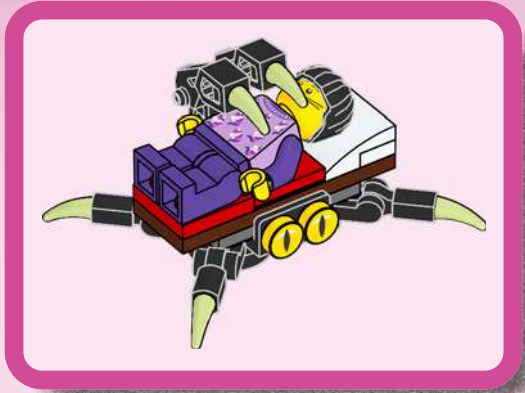
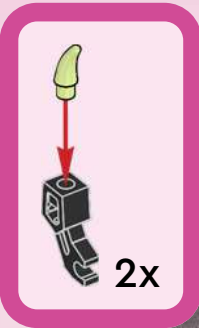



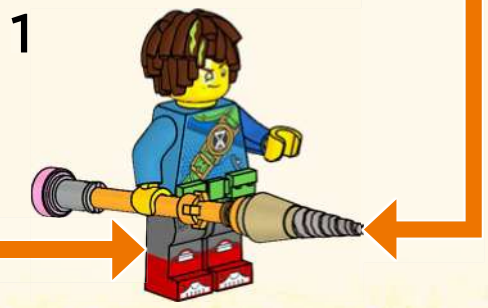
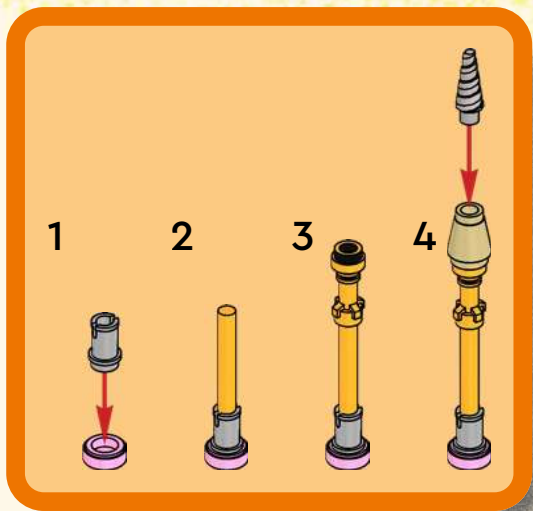
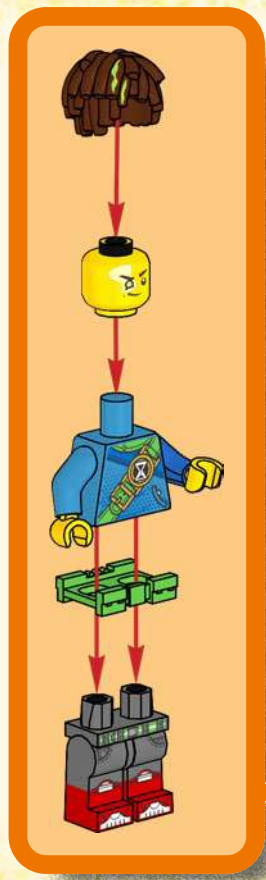

2



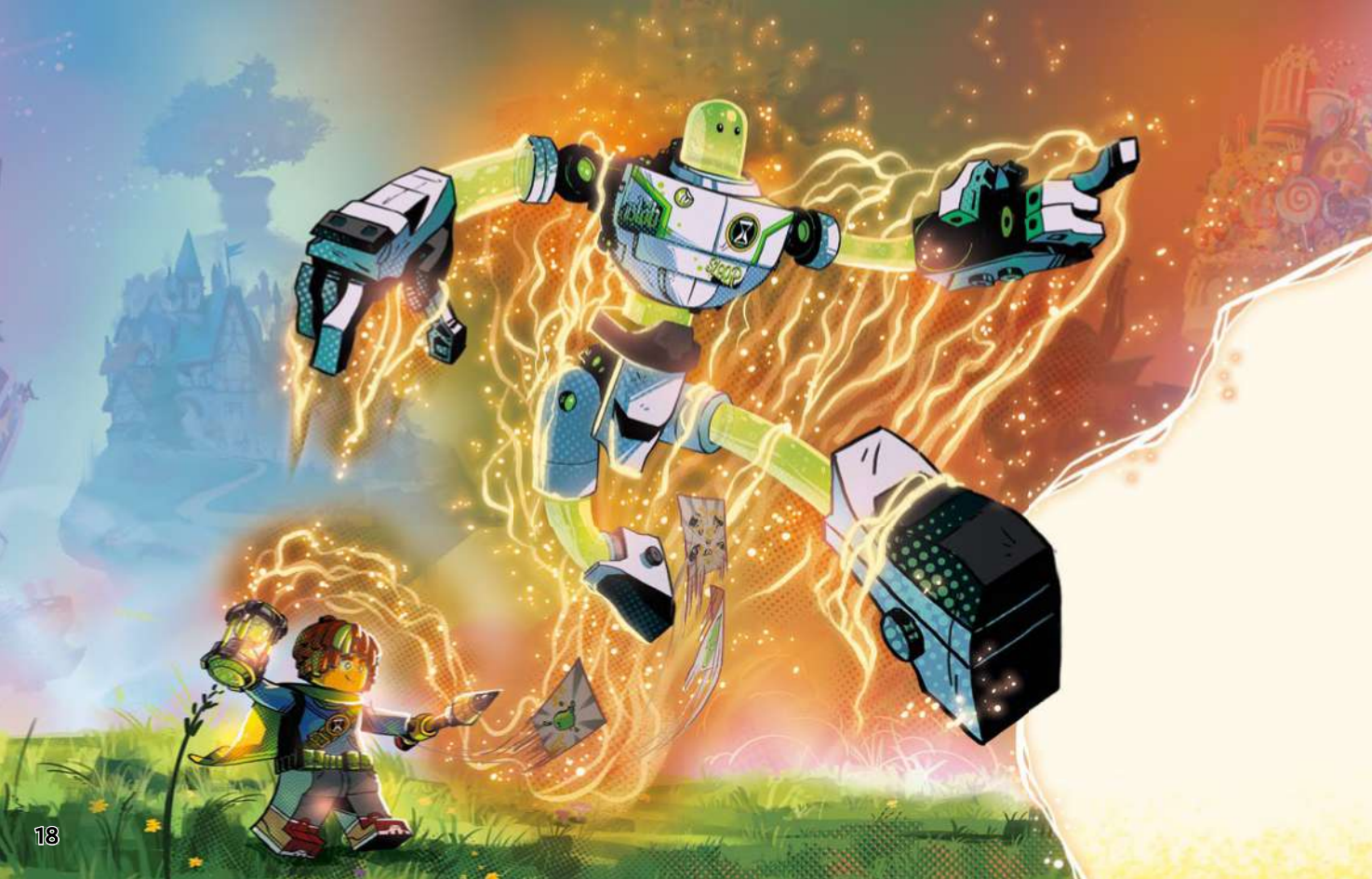



1x



1x

1

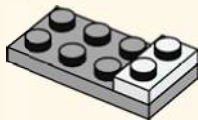

1x

2





1x

3

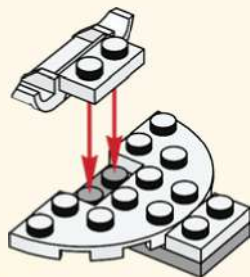

1x



2x

4





1x



1x

5

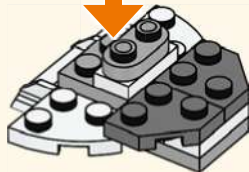

1x



1x

6

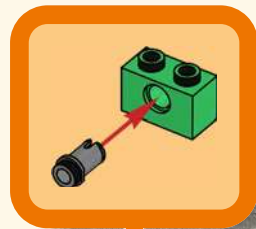



2x



2x

7

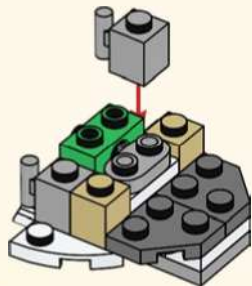

2x

8

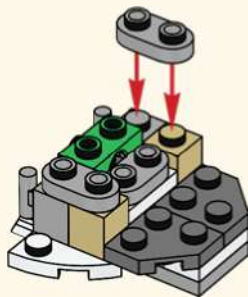



1x

9

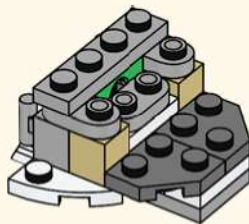

2x

10

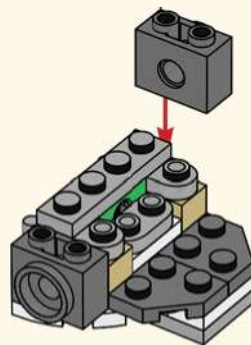



1x



1x

11

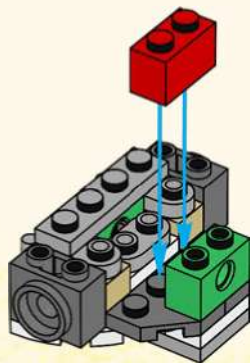

2x



2x

12

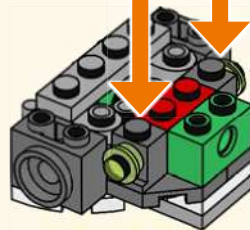
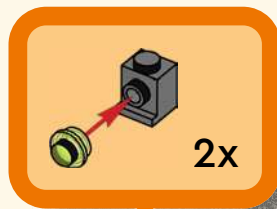

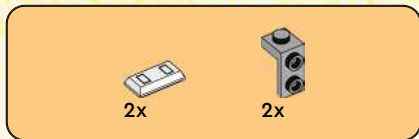

13

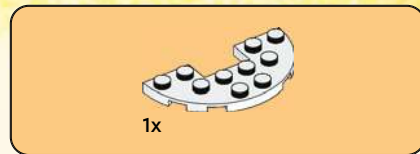
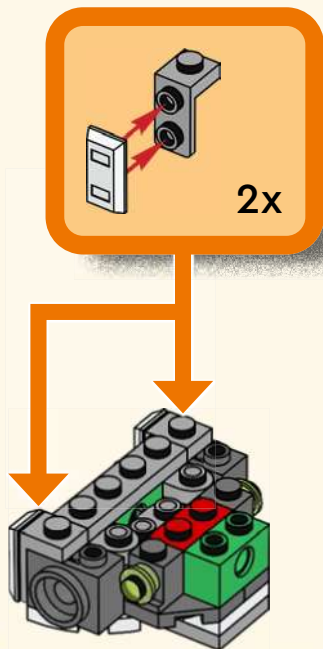

14

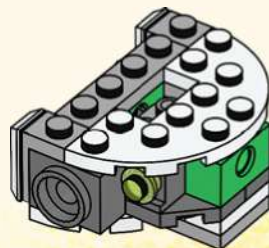



15

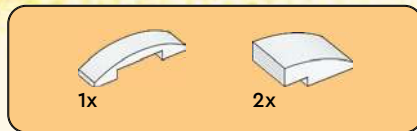
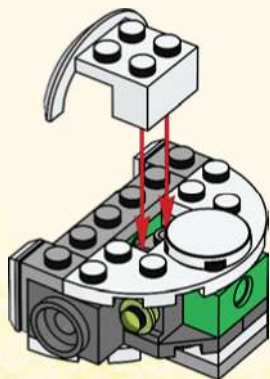

16

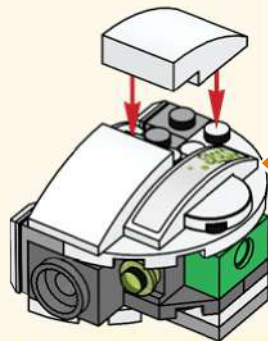
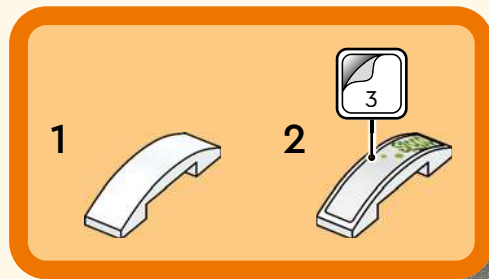

17

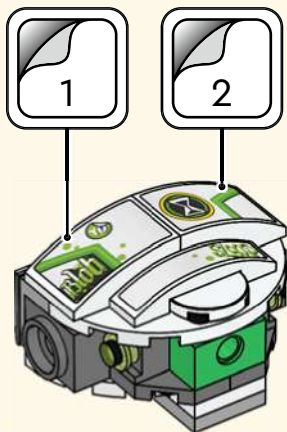

18

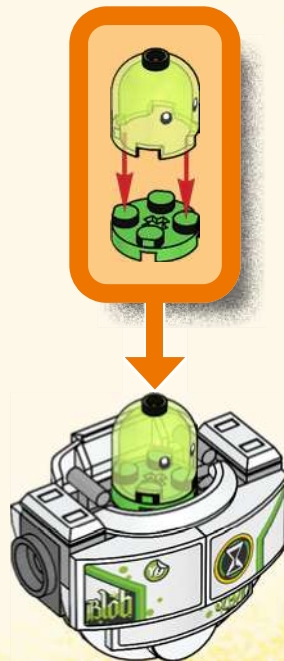



19

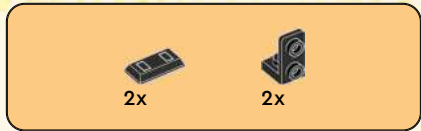

20

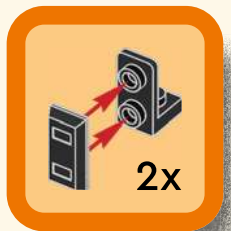



1x

21



2x

22



1x



1x

23





1x

24



1x



1x

25



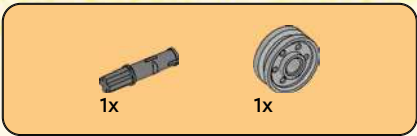

26

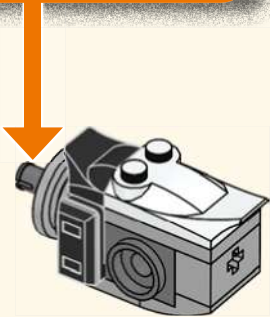
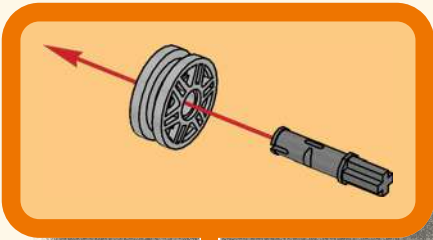

27

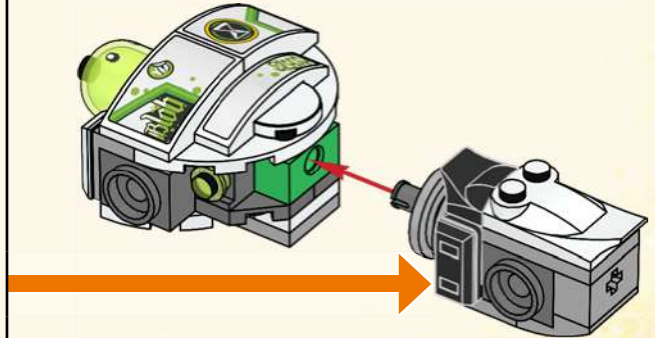
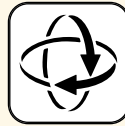

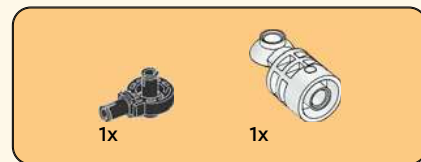

28

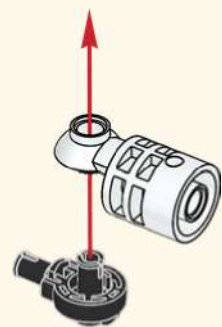



1x

29

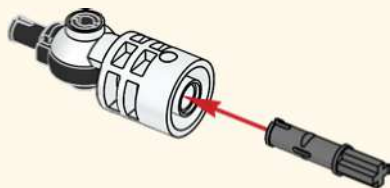

1x

30

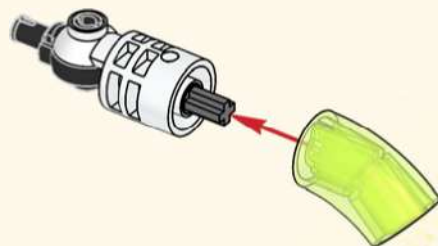

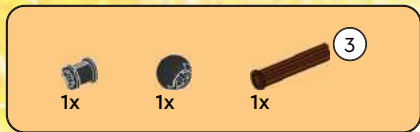

31

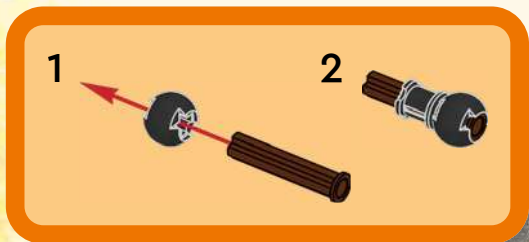

32

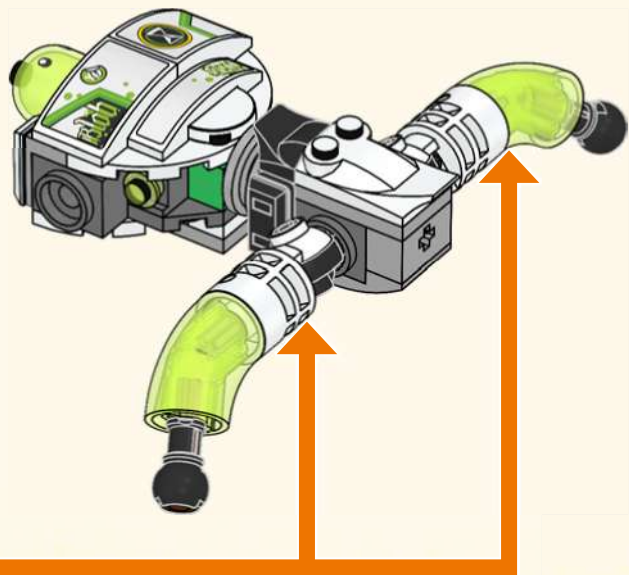

33

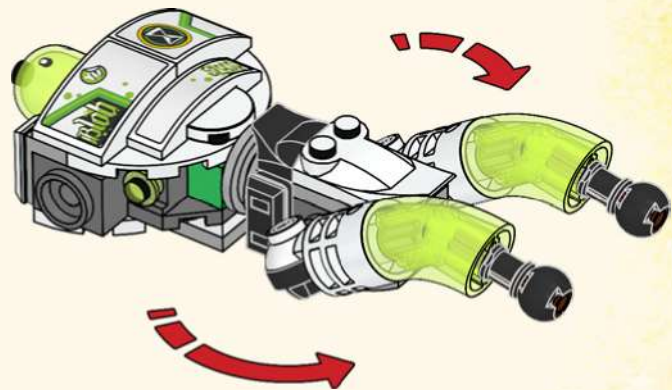



2x



1x



1x

34

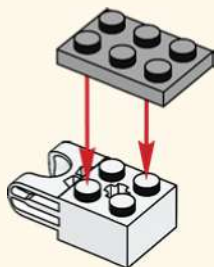

1x

35

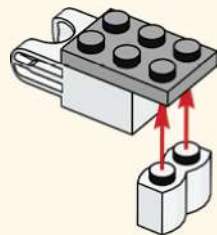



1x

36

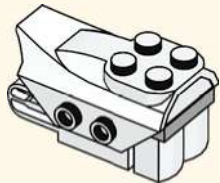

2x

37

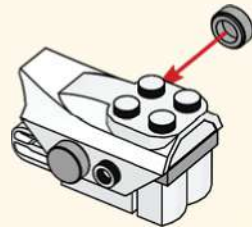



1x

38

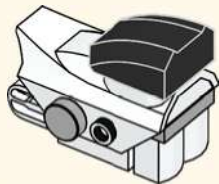

1x

39

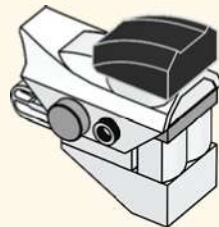

2x

40

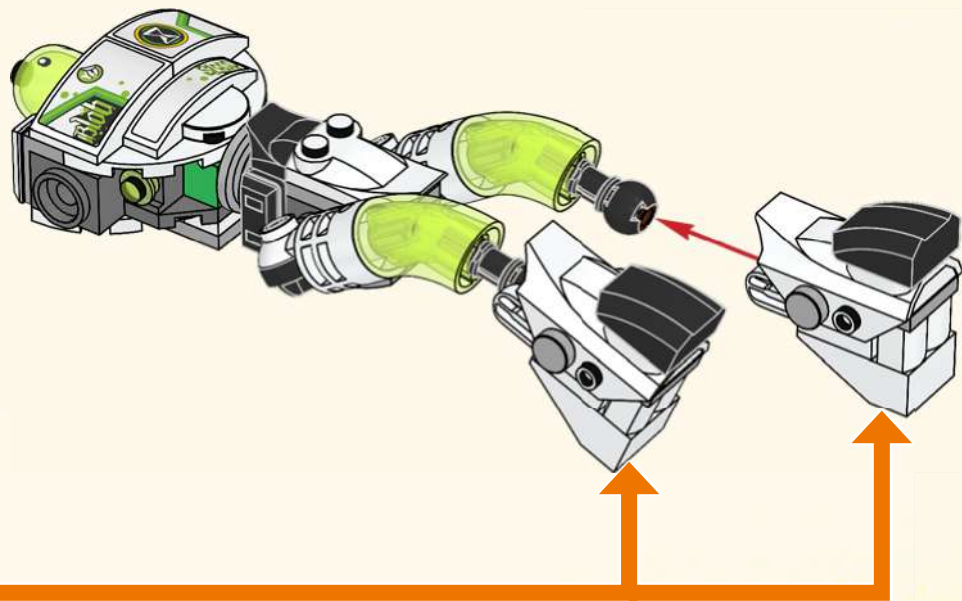



2x



1x



1x

41



1x

42

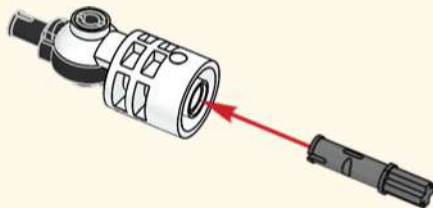



1x

43



1x

44



2x

45

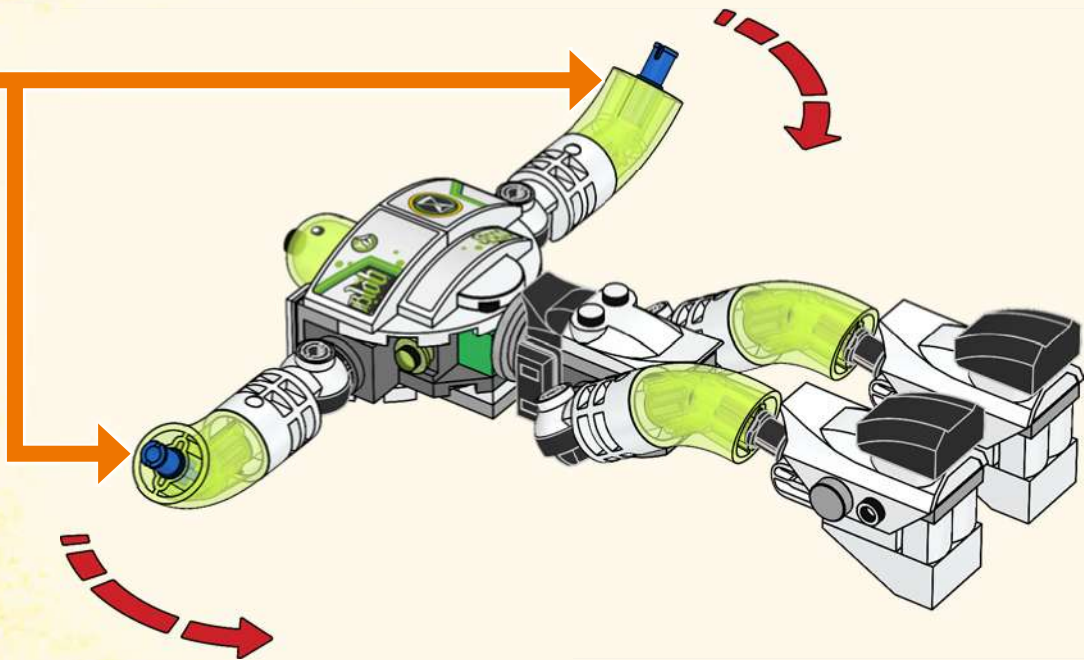



46



47

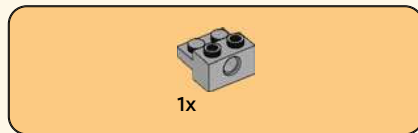

48

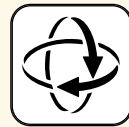



1x

49

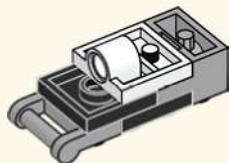

1x

50

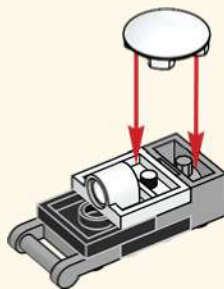



1x

51

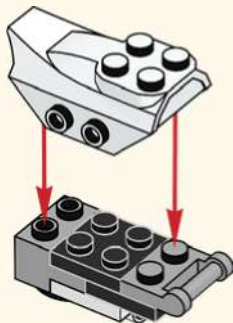

1x



1x

52

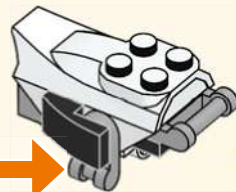
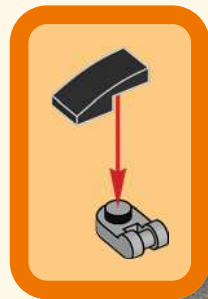



3x

53

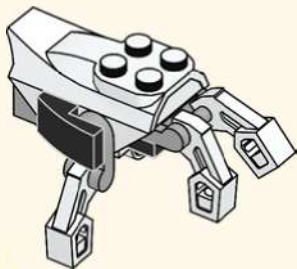

54

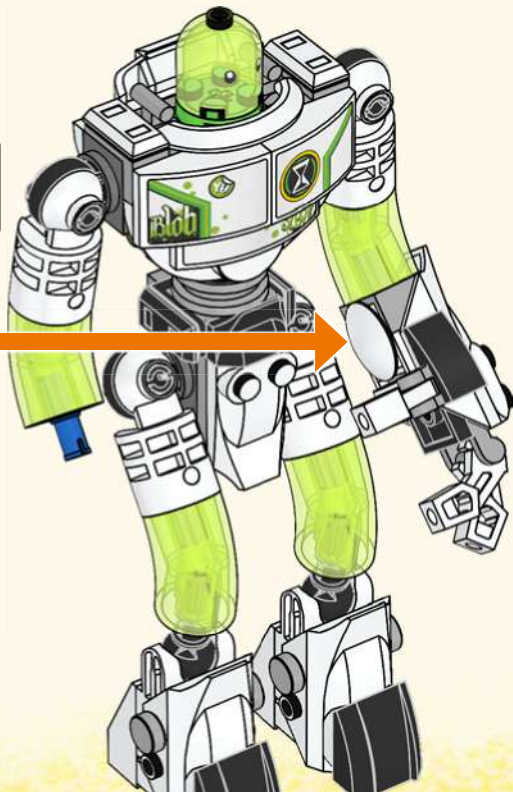
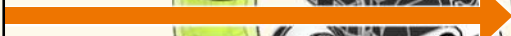



1x



1x

55



1x

56





1x

57

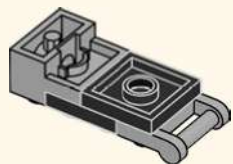

1x

58



1x

59

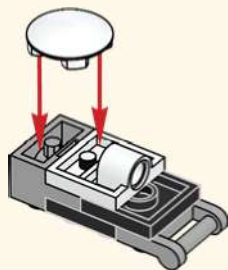



1x

60



1x



1x

61

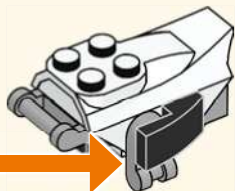
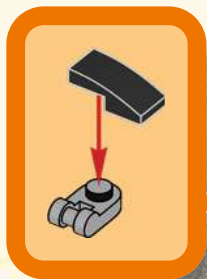

3x

62

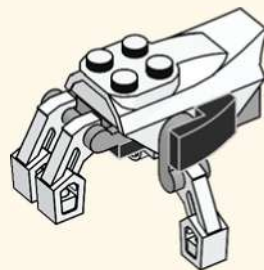

63

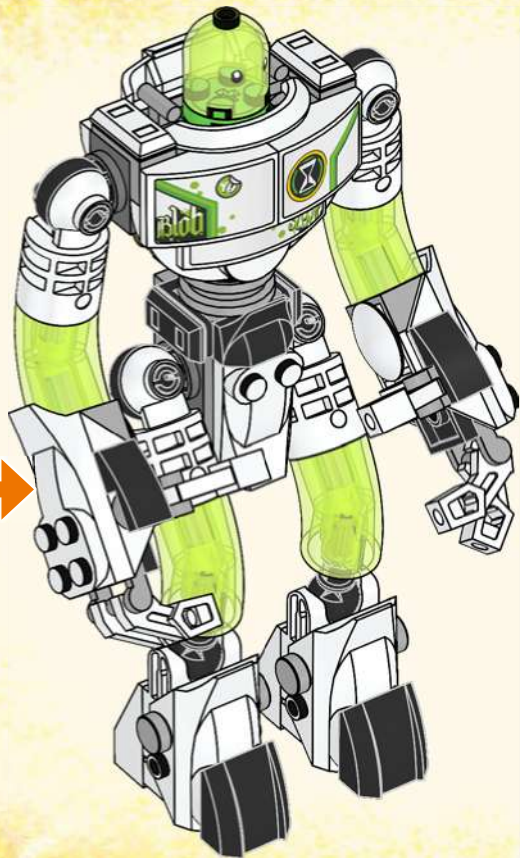

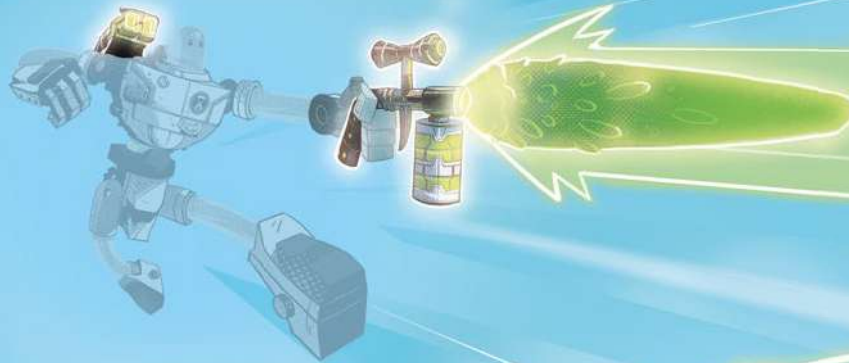

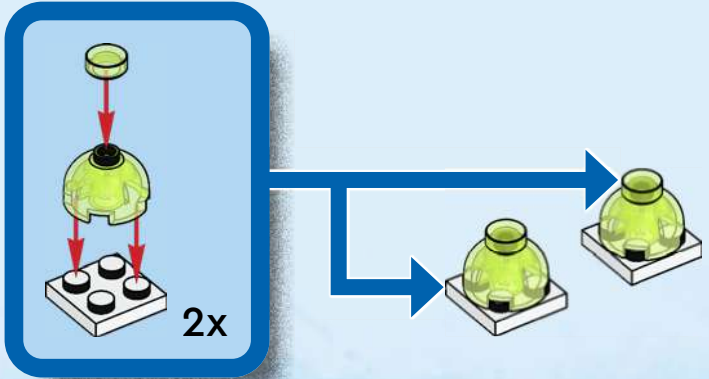

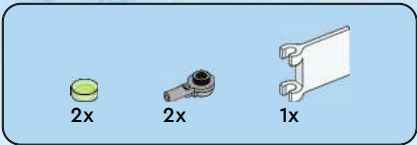

1

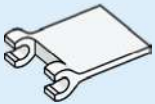

2



3



5



4

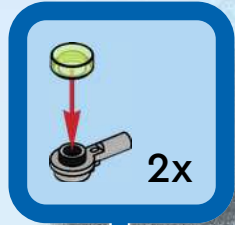
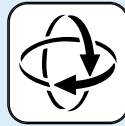

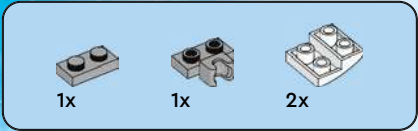

1

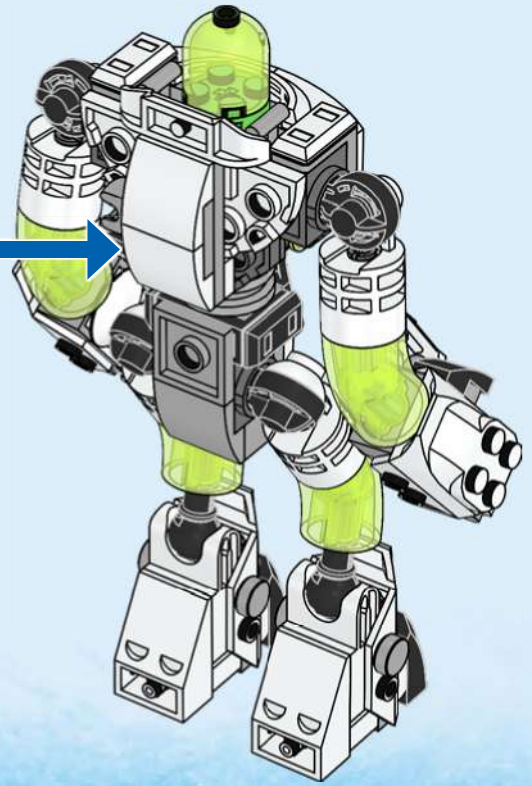
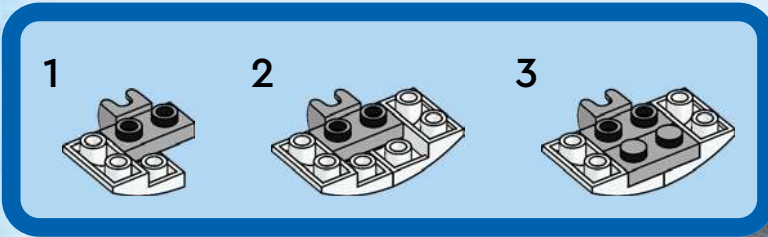

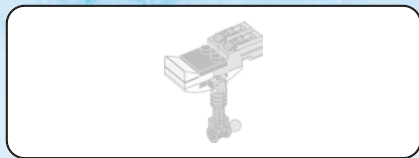

2

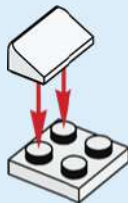

3

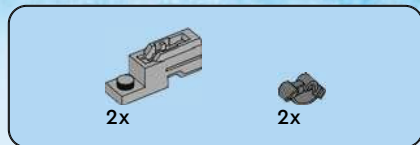
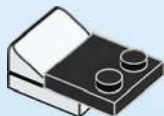

4

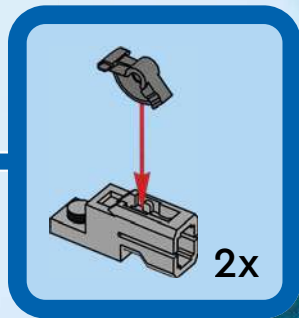
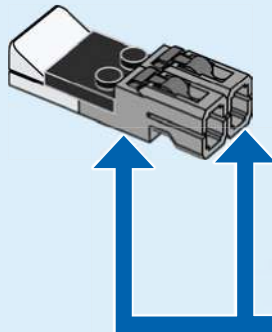



5

1



2



3

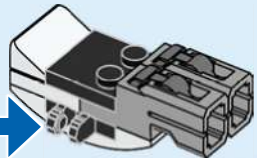

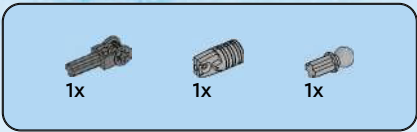

6

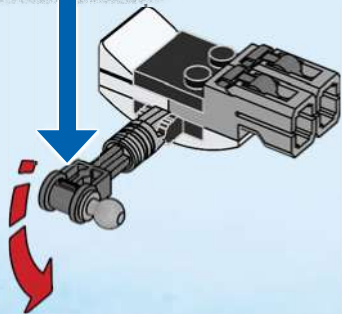
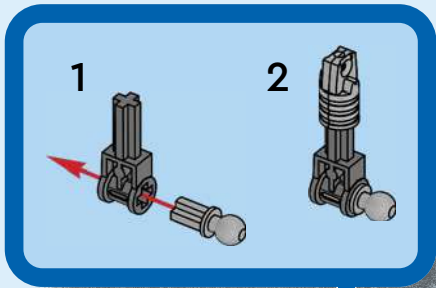

7

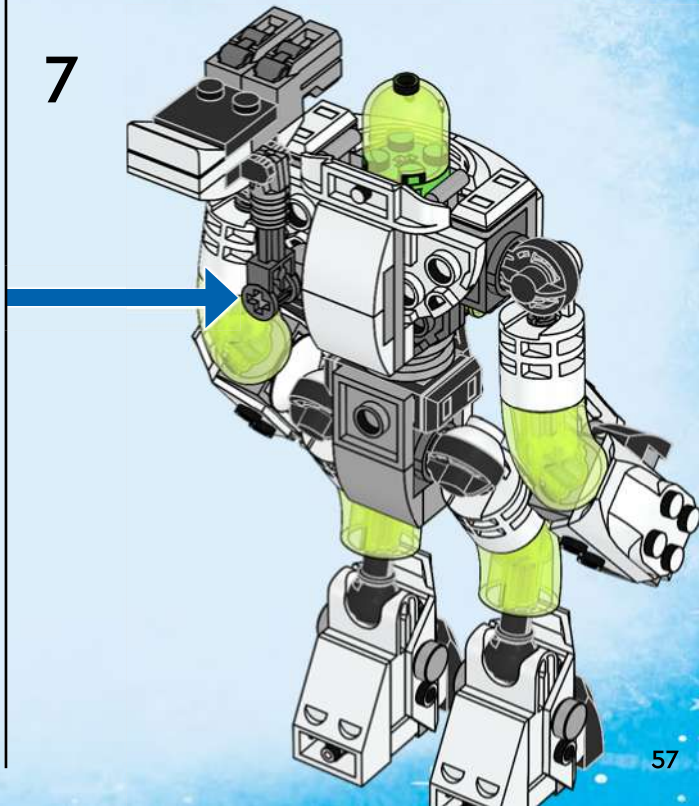



4x



8

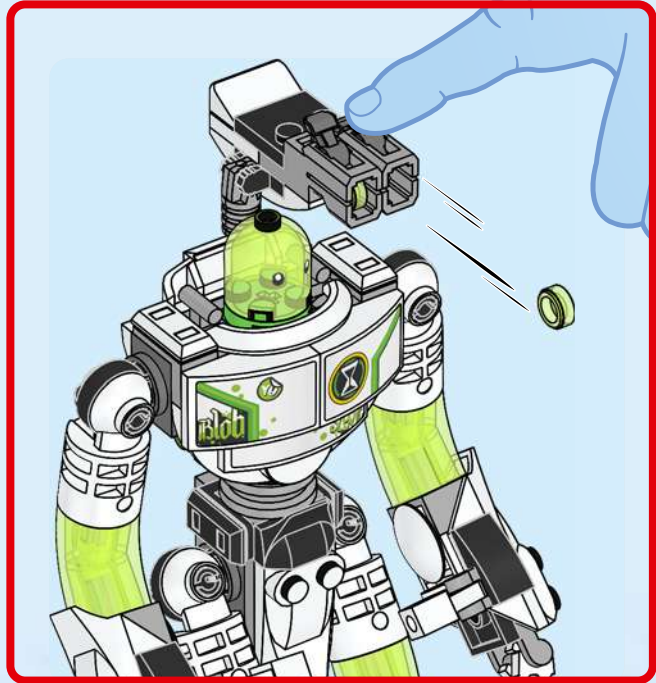
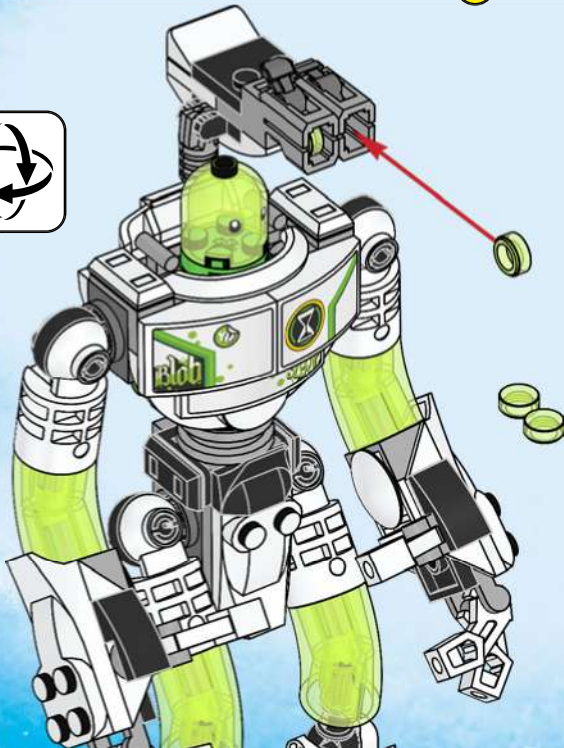

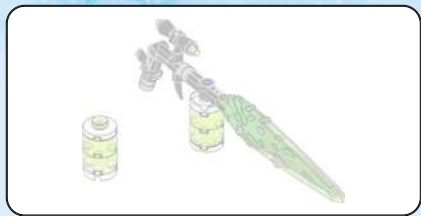

9

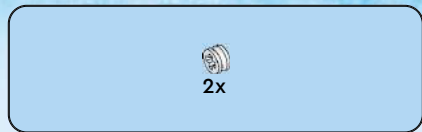

10





1x

11

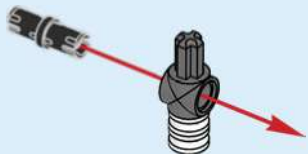

1x

12



1x

13



4

1:1



1x

14



1x

15

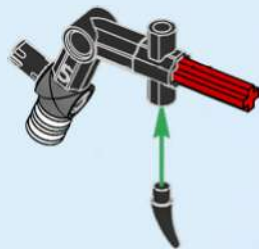



2x

16

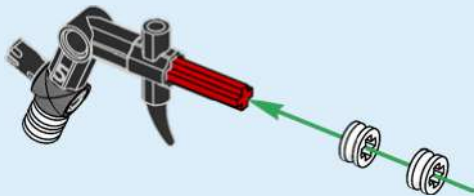

1x

17



1x

18

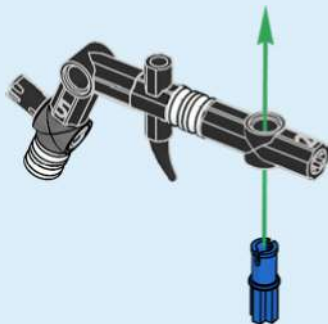

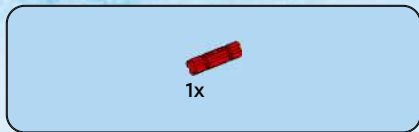

19

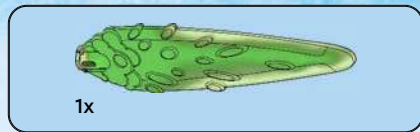
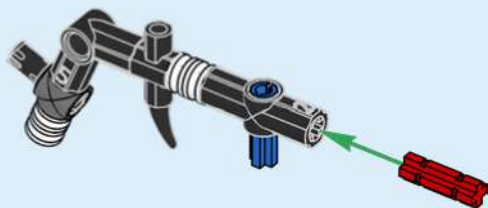

20





2x



1x



1x

21

1



2

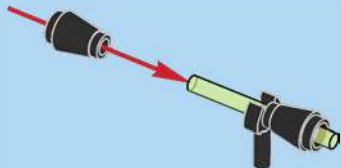

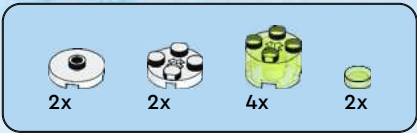

22

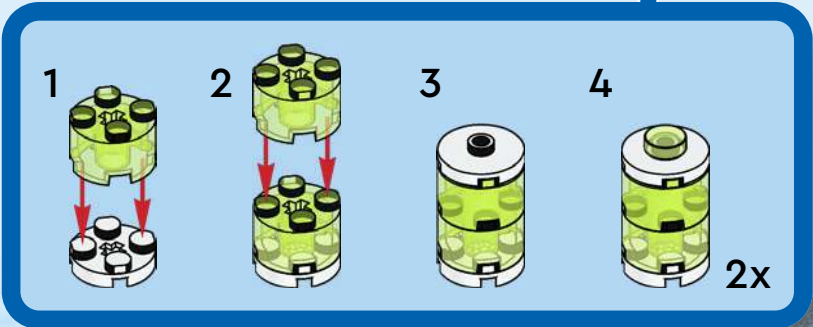
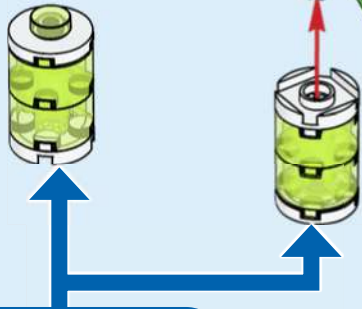

23

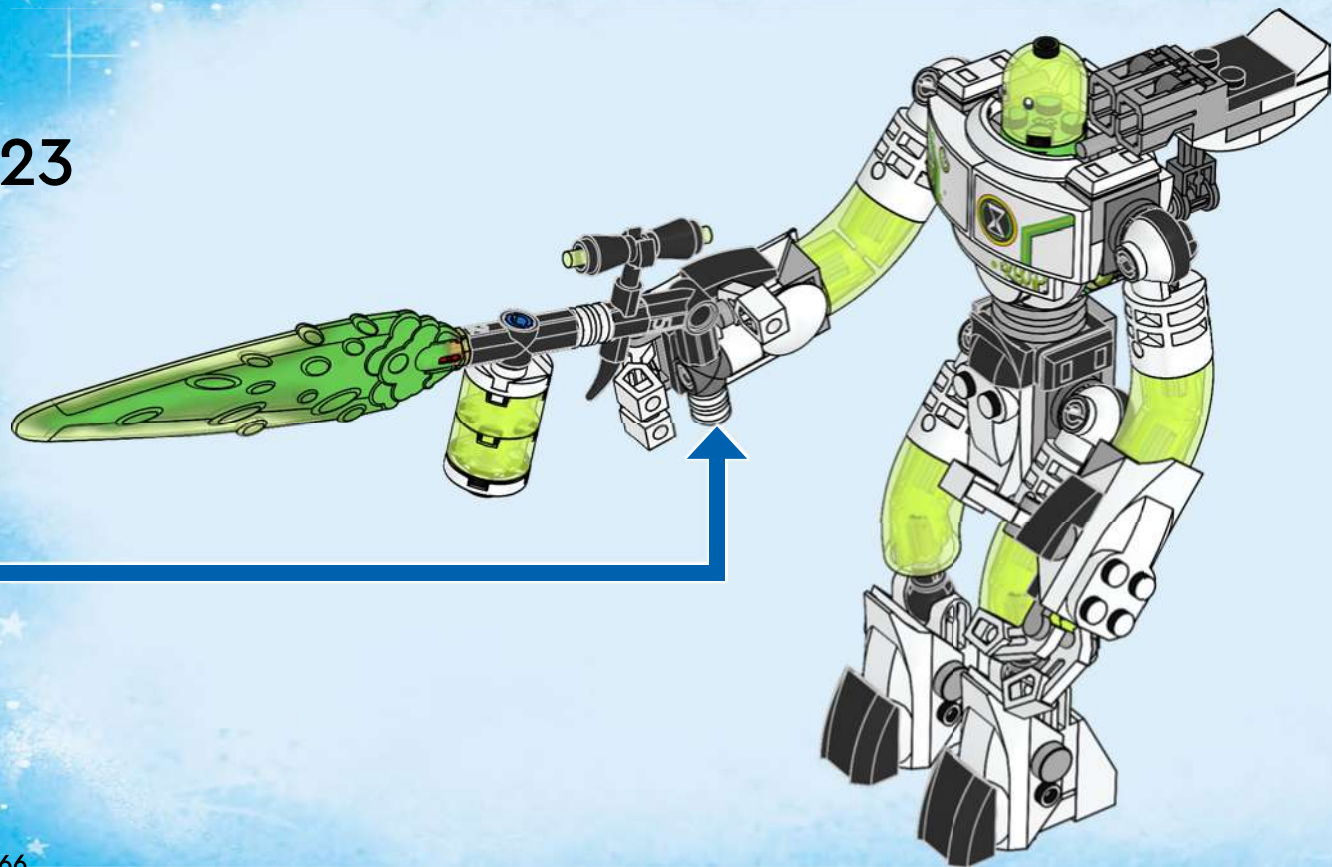



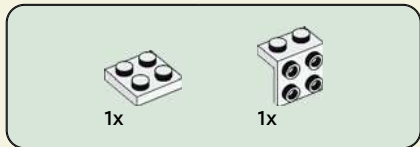

1

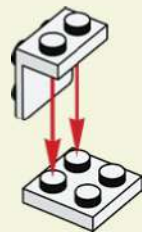



1x

2



1x

3



4x

4





2x

5

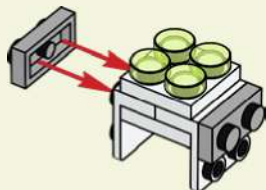

2x

6

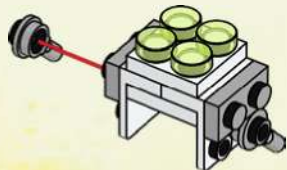

2x



2x

7

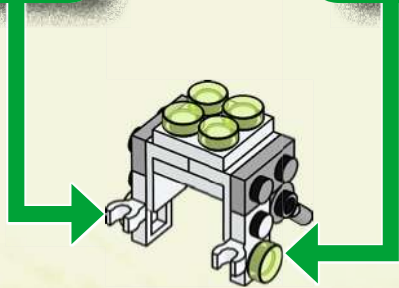

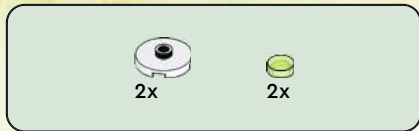

8

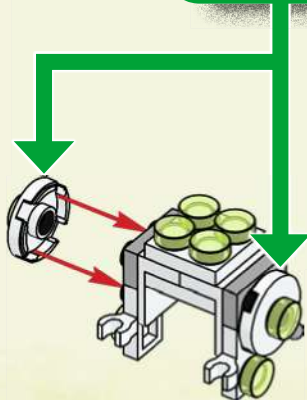
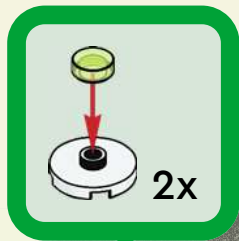

9

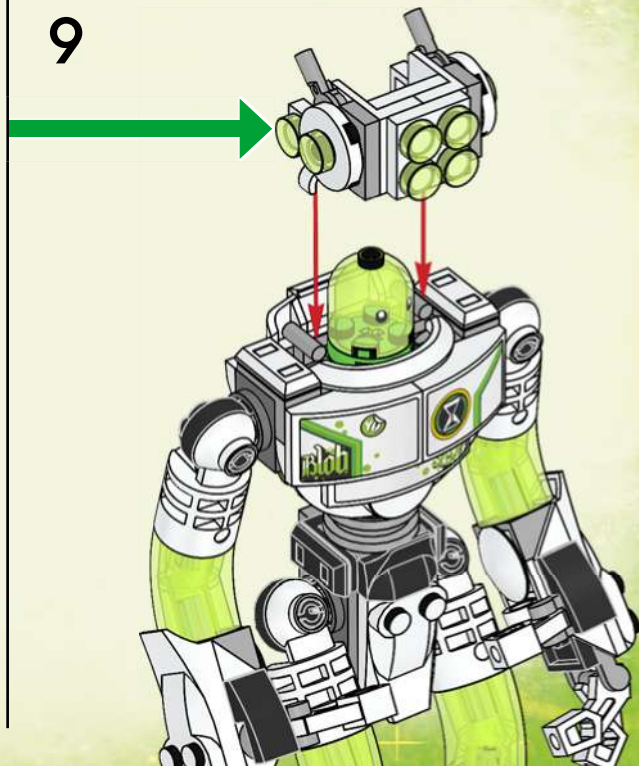



10

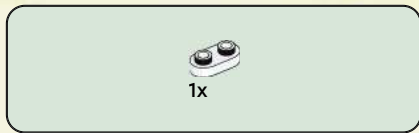

11

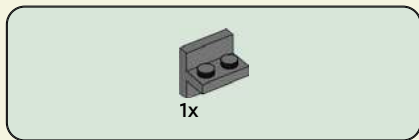

12





13

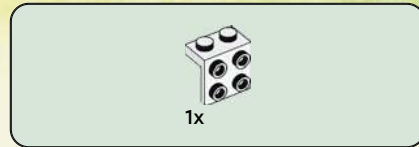
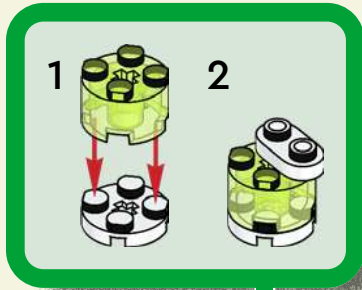

14



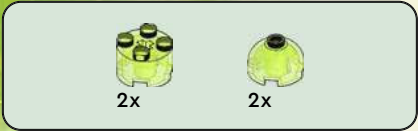

15

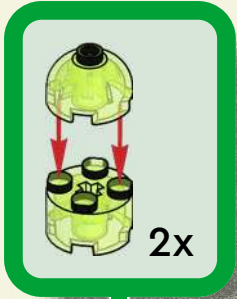

16

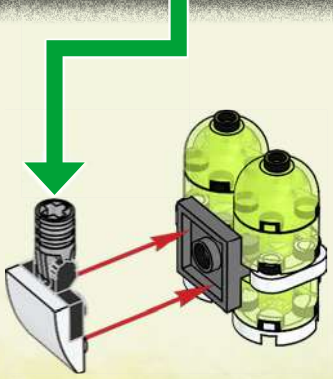
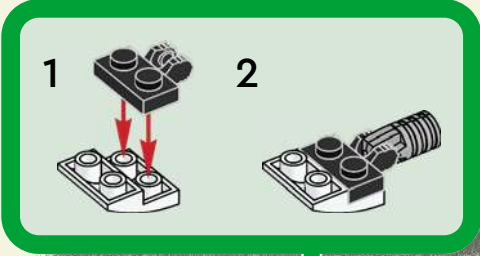

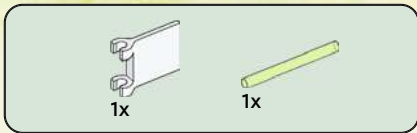

17

1

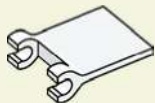

2



3

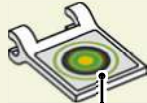

4



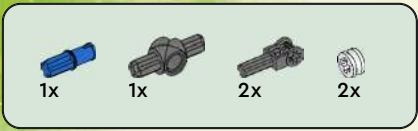

18

1

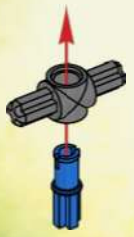

2

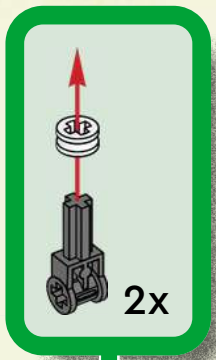
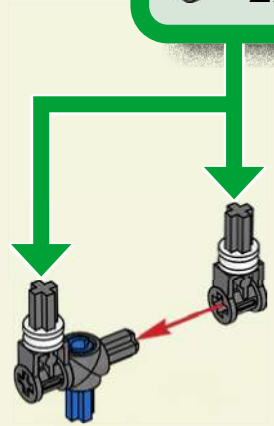

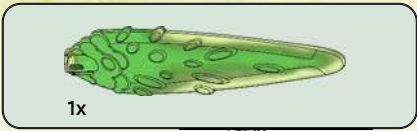

19



20

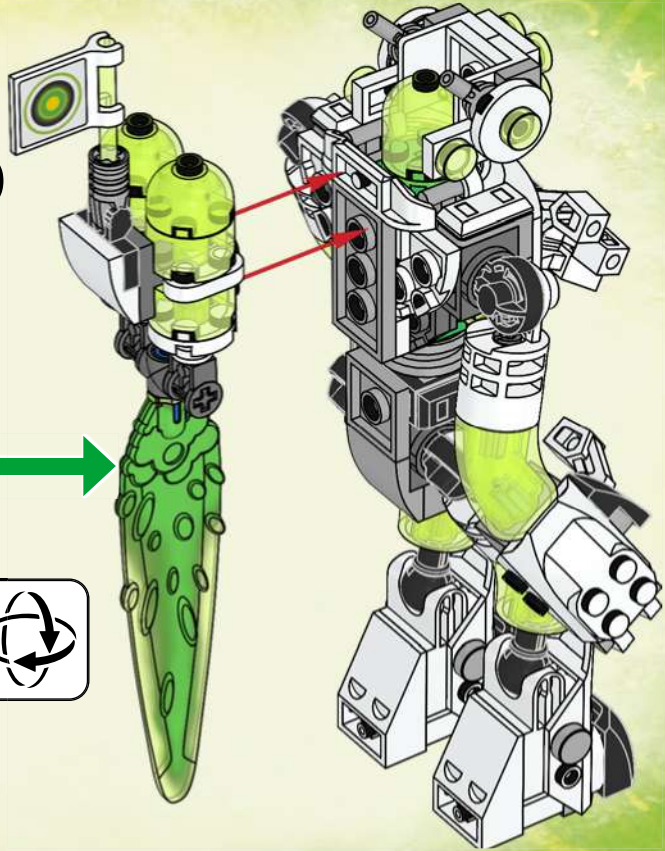
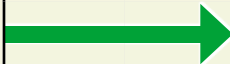



21

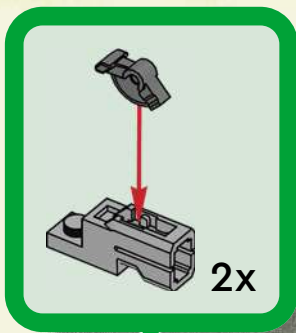

1



2

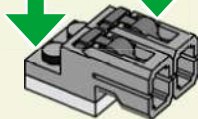

3

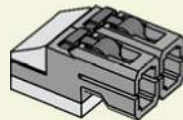

22

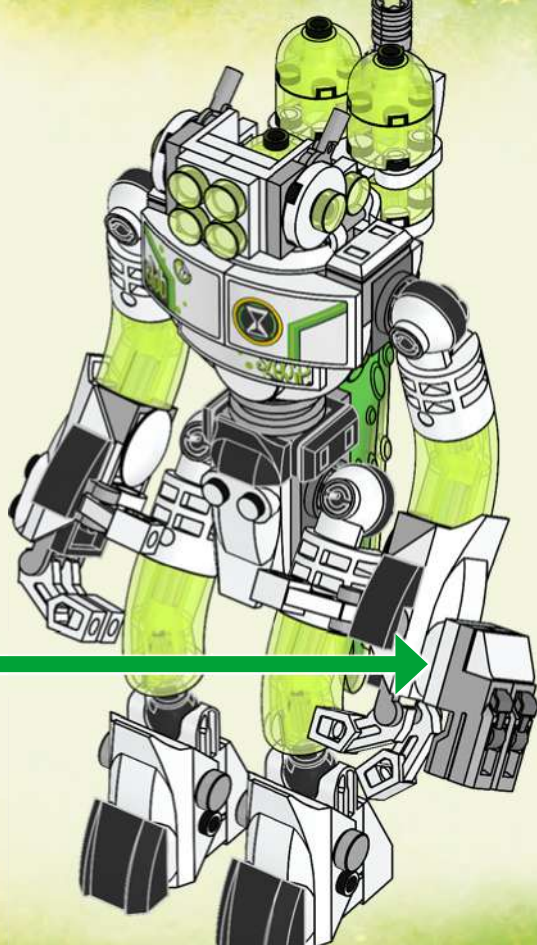



2x

23

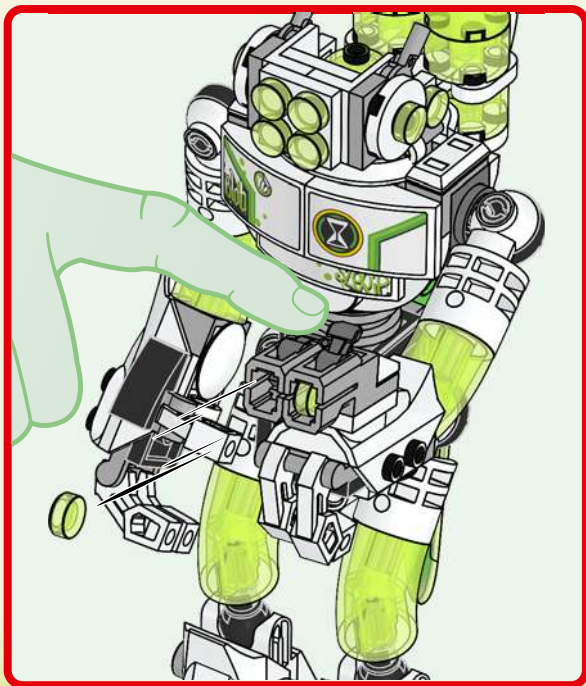
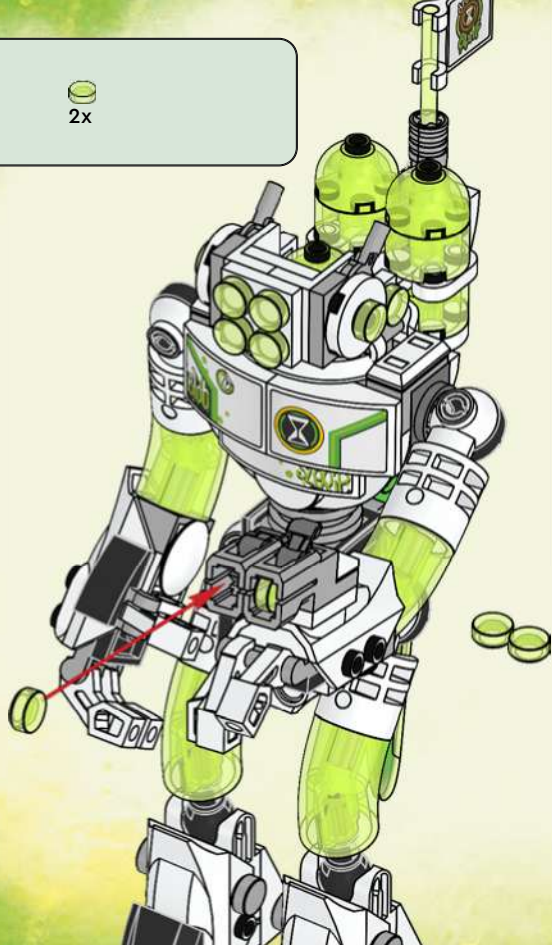



LEGO

DREAMZZZ



71453



71454



71455



71459



71460



71456



71457



71458



71461



71469

Watch series online
Schau dir die Serie online an
Regarde la série en ligne
Guarda la serie online
Mira la serie en Internet
Assistir à série online
在线观剧
Oglądaj serial w internecie
Sleduj seriál online
Pozri si seriál online
Nézd a sorozatot online
Vizionează serialul online
Гледайте сериала онлайн
Skaties seriālu tiešsaistē
Vaata sarja veebist
Žiūrėk serialą internetu



WATCH
SERIES
ONLINE 



[LEGO.com/DREAMzzz](https://www.lego.com/DREAMzzz)



Rebuild
the
world™



 4x 6360263	 2x 6210076	 2x 6435932	 1x 4142865	 1x 4529237	 4x 6157554	 1x 6271346	 1x 6440804
 1x 6434196	 3x 302301	 1x 6249277	 1x 300421	 2x 4113915	 1x 6279875	 1x 4140588	 3x 4206482
 2x 6210272	 2x 6313115	 2x 6132212	 1x 6219819	 1x 6270103	 2x 403226	 4x 4213374	 1x 6134252
 1x 4547489	 3x 6117940	 1x 6170504	 1x 306821	 4x 6315887	 1x 6280097	 4x 302226	 1x 6376752
 2x 403201	 1x 6365487	 1x 4610897	 1x 606821	 2x 4529236	 3x 6276867	 1x 6192346	 1x 6434257
 2x 4278271	 3x 302201	 1x 6023806	 1x 6129995	 1x 6439039	 2x 6047276	 2x 4143875	 2x 6135494
 1x 6044691	 2x 6061024	 2x 6360826	 1x 6434205	 2x 4286267	 1x 6266207	 1x 6271869	 1x 4211247
 2x 6093053	 4x 6210385	 4x 6365687	 1x 6434200	 2x 6332148	 2x 6156991	 2x 6230235	 4x 6284071
 2x 6059185	 1x 6047220	 2x 6192352	 1x 6434200	 1x 6405102	 1x 6375706	 1x 6443372	 1x 4211483
 6x 6276864	 4x 6428169	 2x 6192352	 2x 6434207	 1x 6104209	 1x 6020193	 1x 6443372	 2x 6170569



2x
6362975



1x
6443149



3x
6248890



1x
6265704



2x
6227897



2x
6225246



2x
4211398



1x
6043656



2x
6206249



1x
6044729



2x
4244627



2x
6326478



2x
4211397



1x
6185676



2x
6360382



2x
4211396



1x
4211445



2x
4211395



1x
6284587



1x
6395635



2x
4211044



2x
6360675



1x
6434202



4x
6398662



2x
6164073



2x
4210665



2x
4210665



1x
6250018



1x
6167281



5x
6015356



1x
6307616



1x
4586410



12x
6274748



2x
6240206



2x
6435761



1x
6434203



4x
6296849



1x
6430885



1x
6258883



4x
6430877



1x
6214214



1x
6443399



1x
6443370



6x
6275487



 [LEGO.com/service](https://www.LEGO.com/service)

**YOU COULD
WIN**

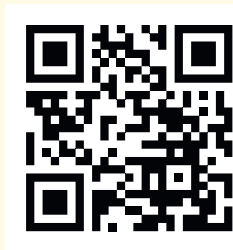

Scan this QR code or go to
LEGO.COM/PRODUCTFEEDBACK and give
us your short feedback about this LEGO® set
for a chance to win a cool LEGO prize.

Terms and Conditions apply*

EN: YOU COULD WIN. Terms and Conditions apply* **DE: Du könntest GEWINNEN.** Es gelten die Teilnahmebedingungen* **FR: Tu pourrais GAGNER.** Des conditions s'appliquent* **IT: Potresti VINCERE tu.** Termini e condizioni sono applicabili* **ES: Puedes GANAR.** Aplican términos y condiciones* **PT: Poderá GANHAR.** Aplicam-se termos e condições* **ZH: 轻松获奖. 条款和条件适用*** **PL: Szansa na WYGRANĄ.** Obowiązują warunki korzystania* **CS: Máte šanci VYHRÁT.** Platí všeobecné smluvní podmínky* **SK: Máte šancu VYHRÁŤ.** Platia všeobecné zmluvné podmienky* **HU: TE IS NYERHETSZ.** Felhasználási feltételek érvényesek* **RO: Ai putea CÂȘTIGA.** Se aplică termenii și condiții* **BG: Можете да СПЕЧЕЛИТЕ.** Има определени правила и условия* **LV: Tu vari LAIMĒT.** Ir spēkā noteikumi un nosacījumi.* **ET: Sul on võimalus VÕITA.** Kehtivad tingimused* **LT: Jūs galite LAIMĖTI.** Taikomos sąlygos*

*[LEGO.com/productfeedback-terms](https://www.lego.com/productfeedback-terms)