



CARNIVOROUS PLANTS

☐ These plants have developed the most cunning ways to lure in and trap their prey. With snares, pitfalls, adhesives, snap traps and other curious contraptions, these captivating creations almost seem like hybrids between flora and fauna. Over 600 different known species can gobble up a veritable buffet of gullible animals, from insects and larvae to crustaceans and even smaller mammals!



(Dionaea muscipula)

VENUS FLYTRAP

Native to North Carolina and South Carolina in the United States.



(Drosera brevifolia)

RED SUNDEW

Native to the south-eastern United States.



(Sarracenia flava)

**YELLOW
PITCHER PLANT**

Native to the south-eastern United States.



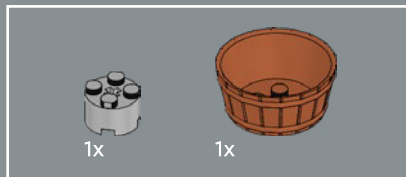

1

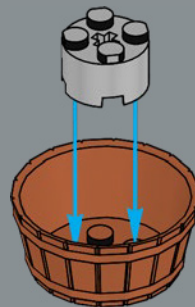

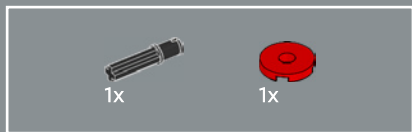

2

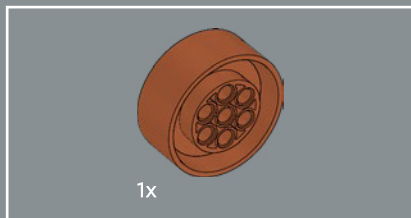
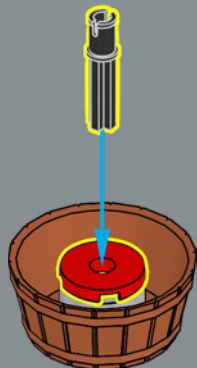

3

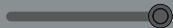
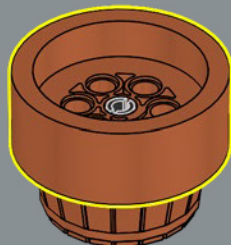



4

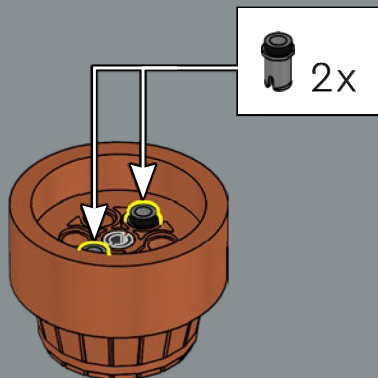

5

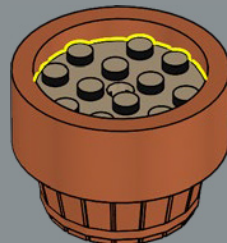

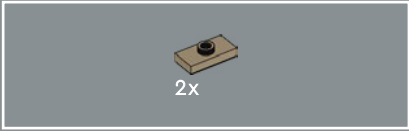

6

The Venus flytrap has sensor hairs around its two leaves that trigger its trap; when an insect touches the hairs, it will cause the jaws to close and capture the prey inside.

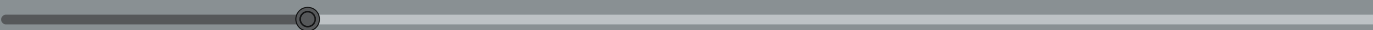
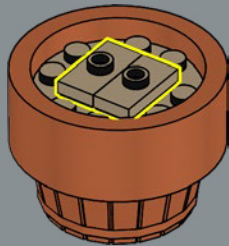



7



8





2x

9

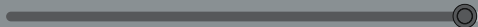



10

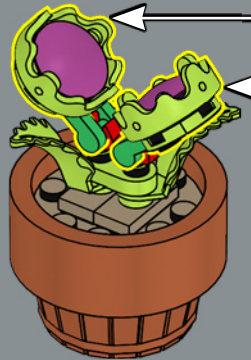
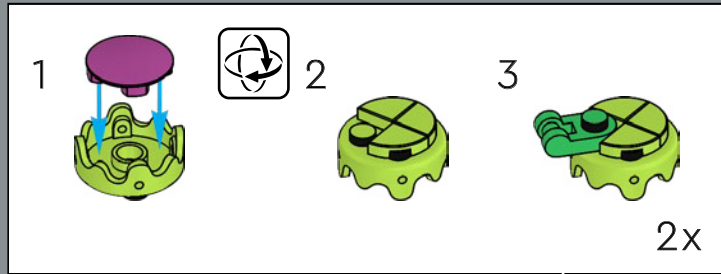

Does this piece used for the jaws of the flytrap remind you of anything? The element was originally designed as icing for a cake. This is the first time it has been used in lime green.

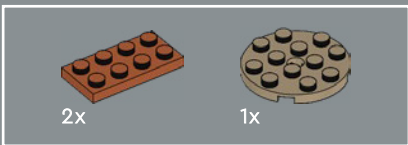
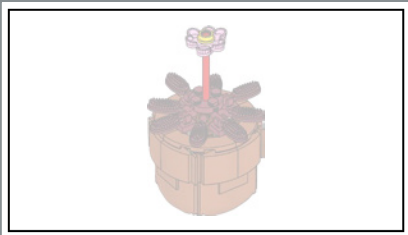

1

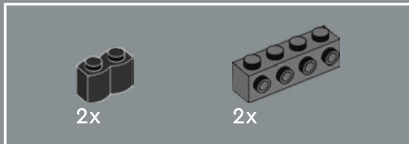
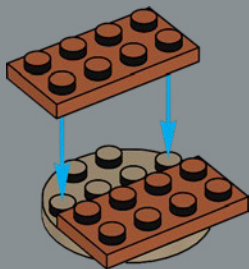

2

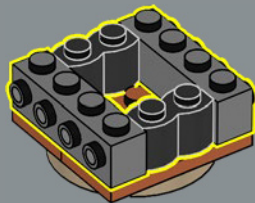

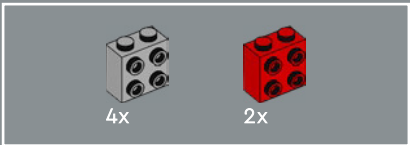

3

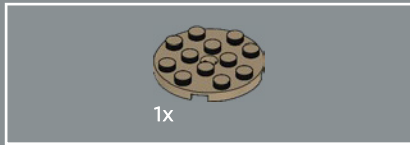
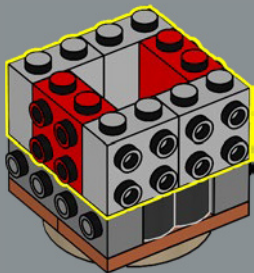

4

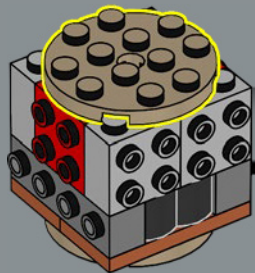

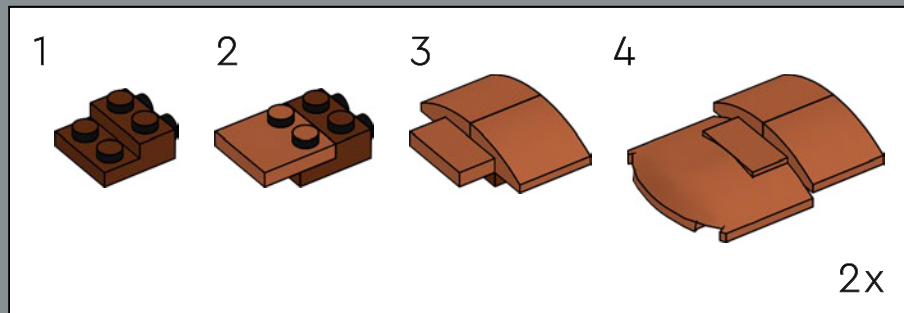
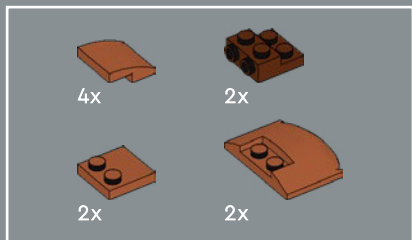

5

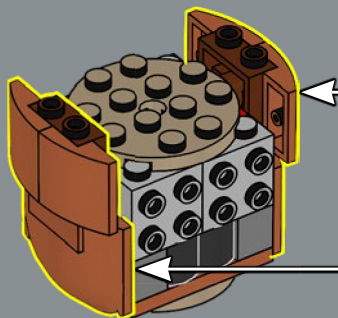

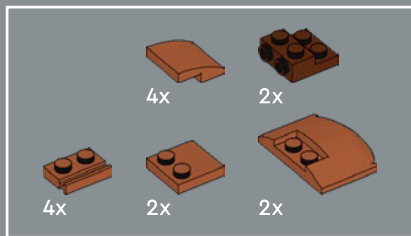

6

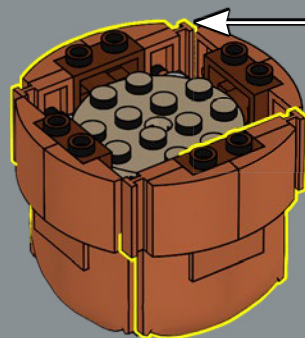
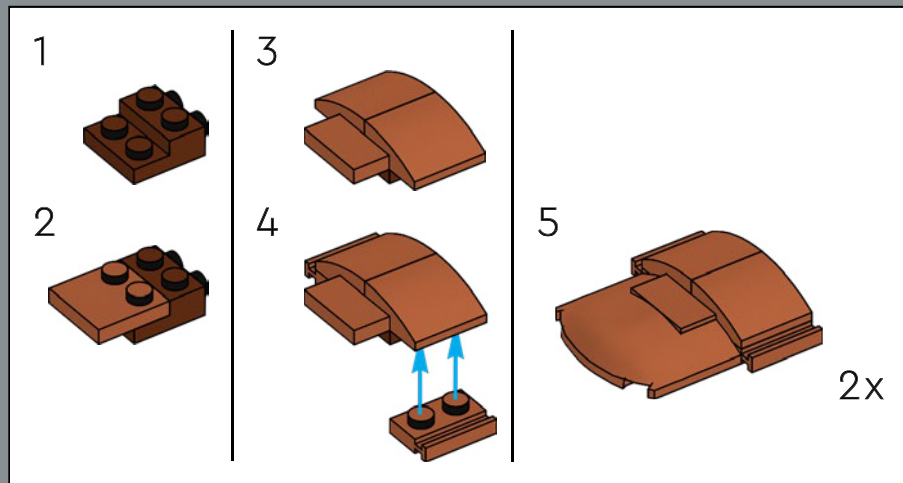

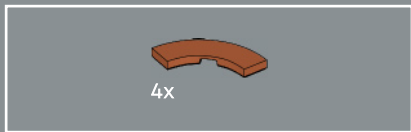

7

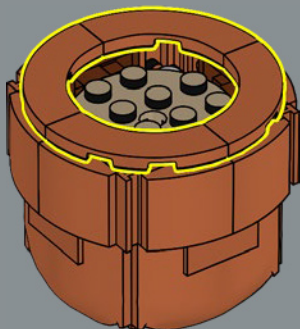

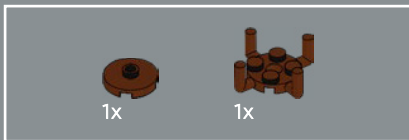

8

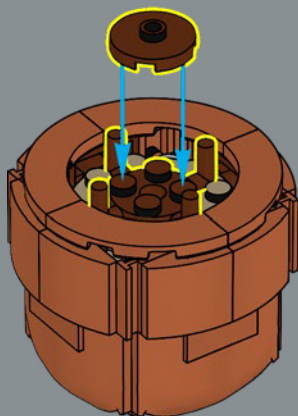

This carnivorous plant uses thousands of tiny hairs, each tipped with a bead of sticky liquid, to trap its prey. Once the insect is stuck to the leaves, they will curl inwards around the unsuspecting little bug.



1x



1x

9



1x

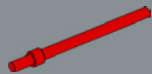

1x

10





11

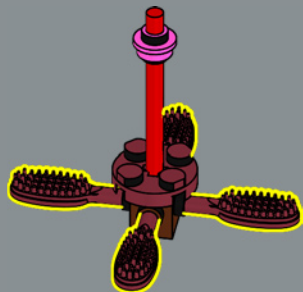

12

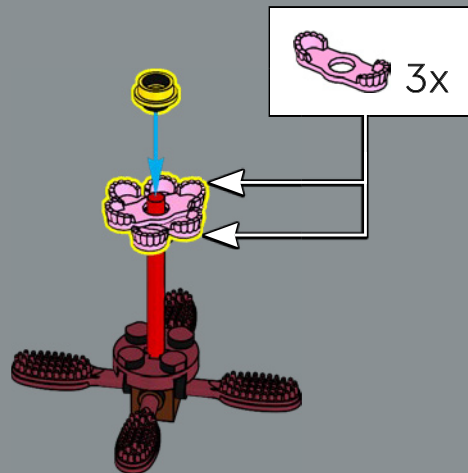

Pink epaulets make the leaves of the sundew flower, a first in this colour. If you happen to have a LEGO® Captain Red Beard minifigure, you could turn him into Captain Pink Beard.

13

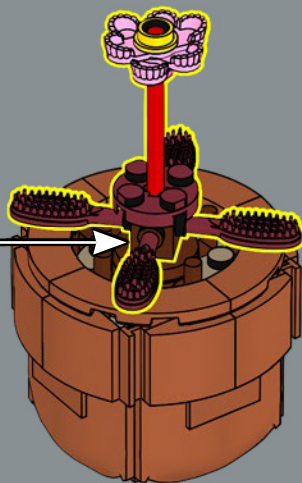

Could it be? Yes, these are actually little LEGO® hairbrushes.

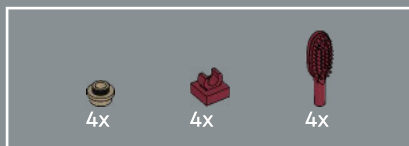

14

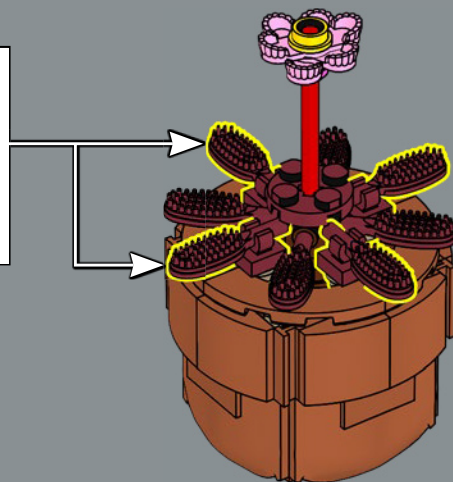
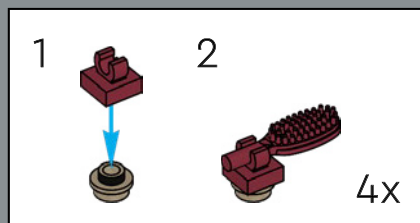

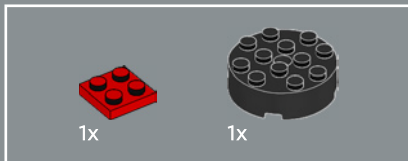
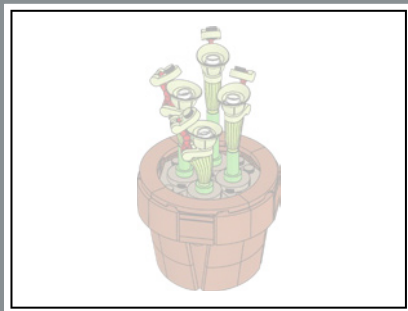

1

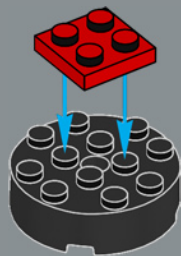



2

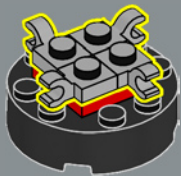

3

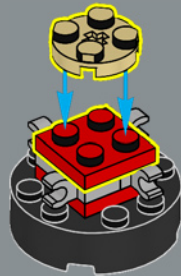



4



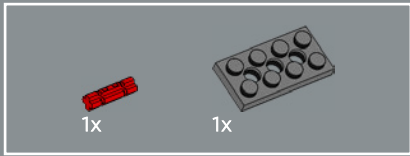

5

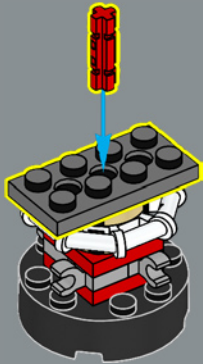

6



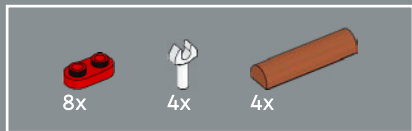

7

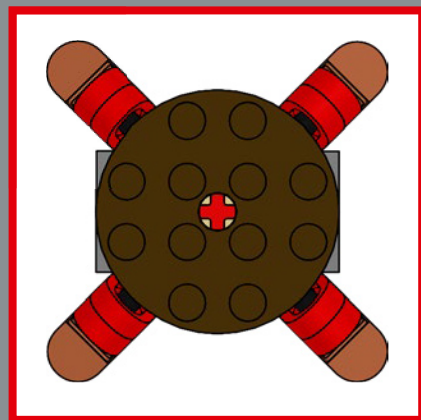
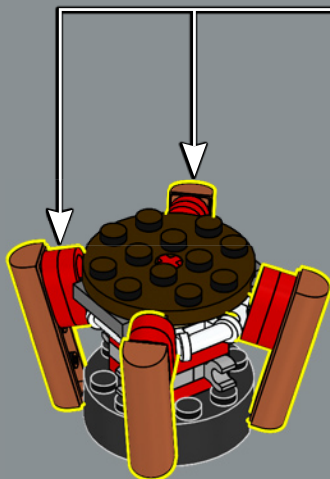
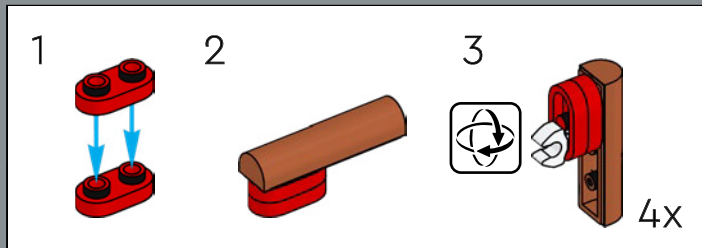

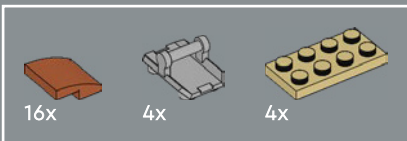

8

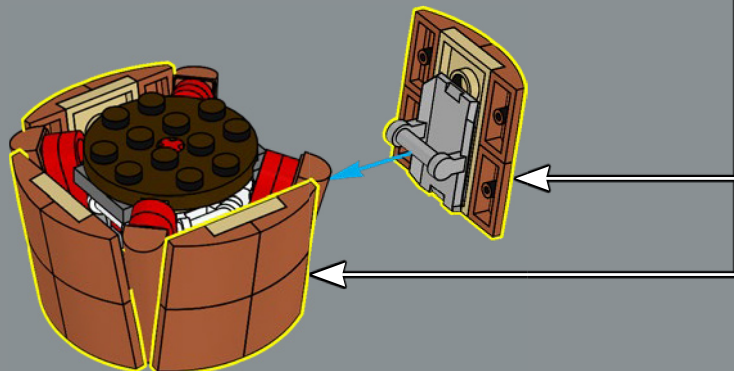
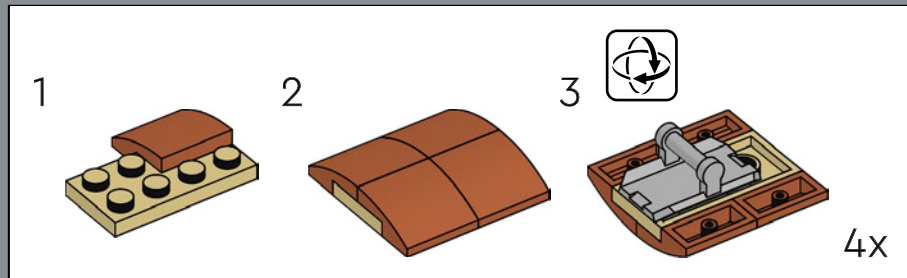

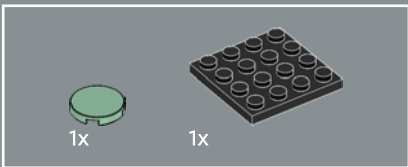
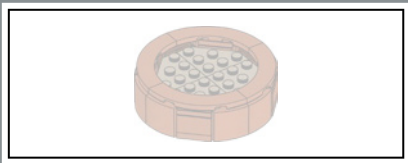

9

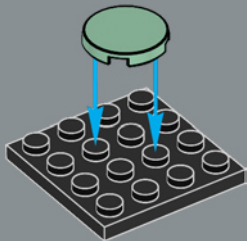



10

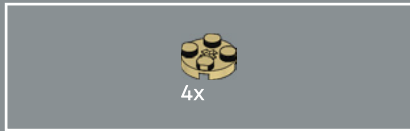
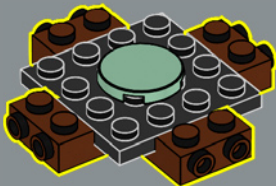

11

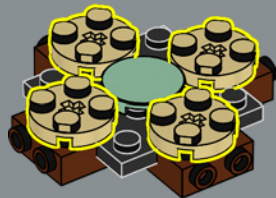



12

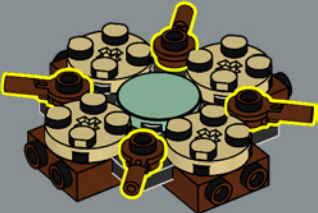

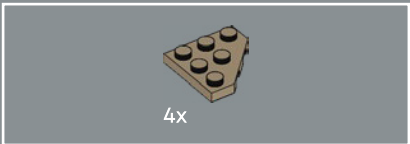

13

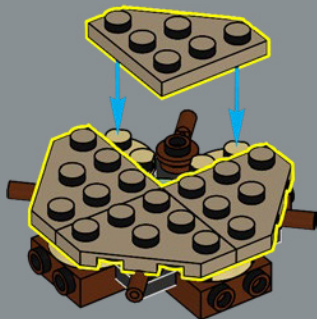



14

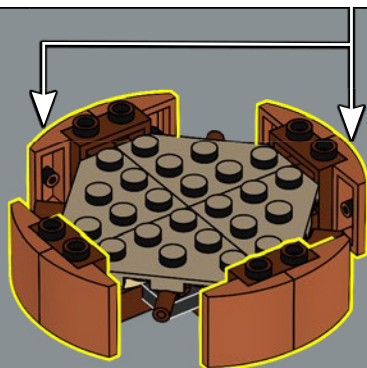
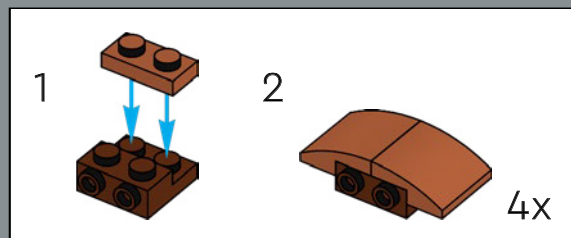

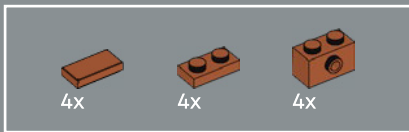

15

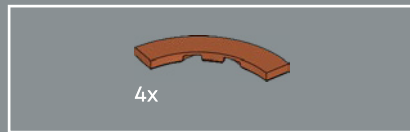
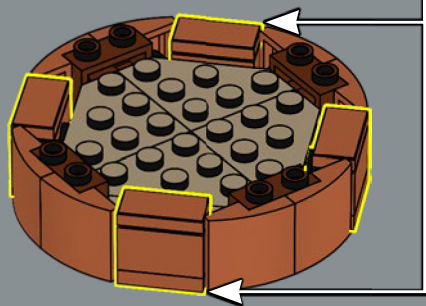
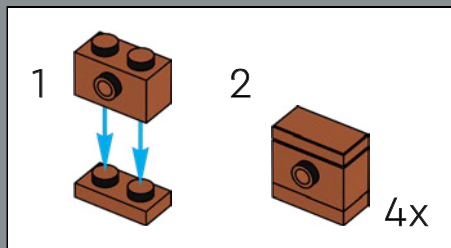

16

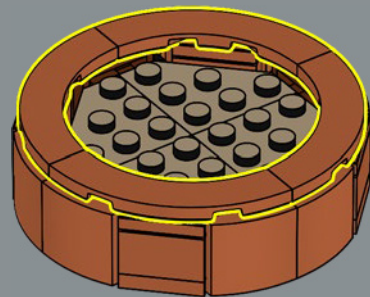

17

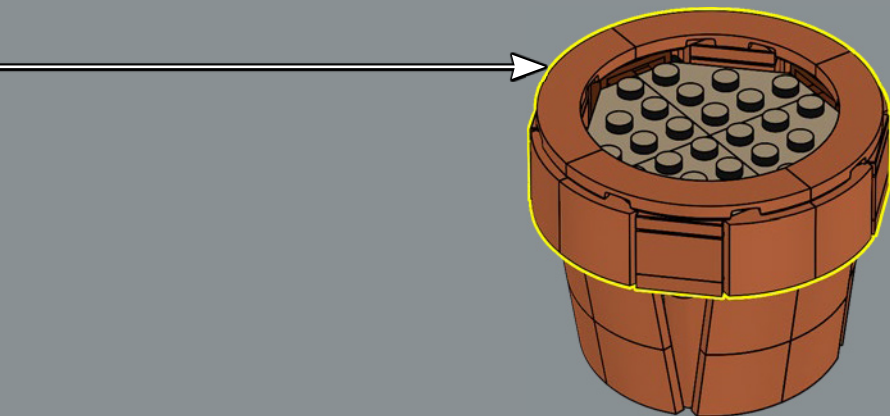

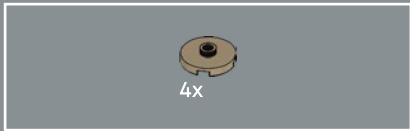

18

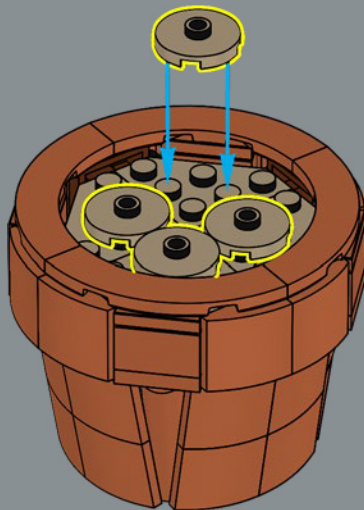



4x

19

Nothing is more refreshing than a pitcher of digestive enzymes!
The cups of these plants are filled with digestive juices to break
down the unfortunate insects that fall in.

To prevent accidental activations, two sensor hairs need to be
triggered before the trap closes.

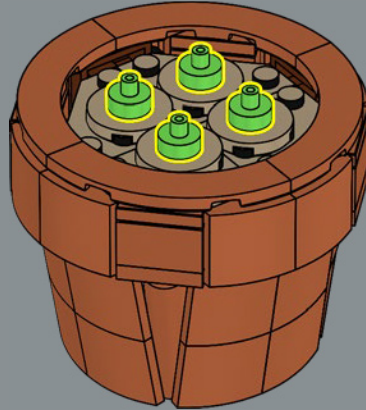



20

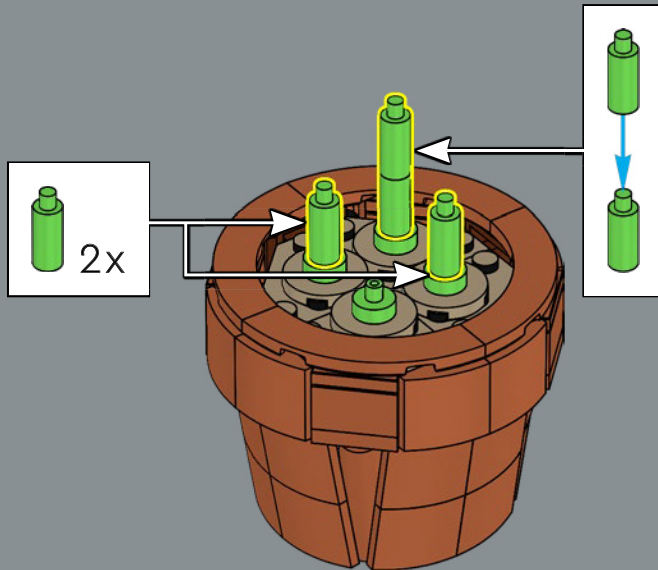



Interesting elements alert: These pitcher plants use an explorer helmet in bright spring green for the opening of the pitcher, and a lime green broom head for the stalk.



21

1

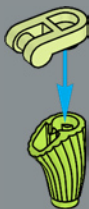

2



3



4



4x

Surprisingly, the leaf that grows above the pitcher cannot move and seal the pitcher. Instead, it prevents rain from entering and diluting the liquid within.

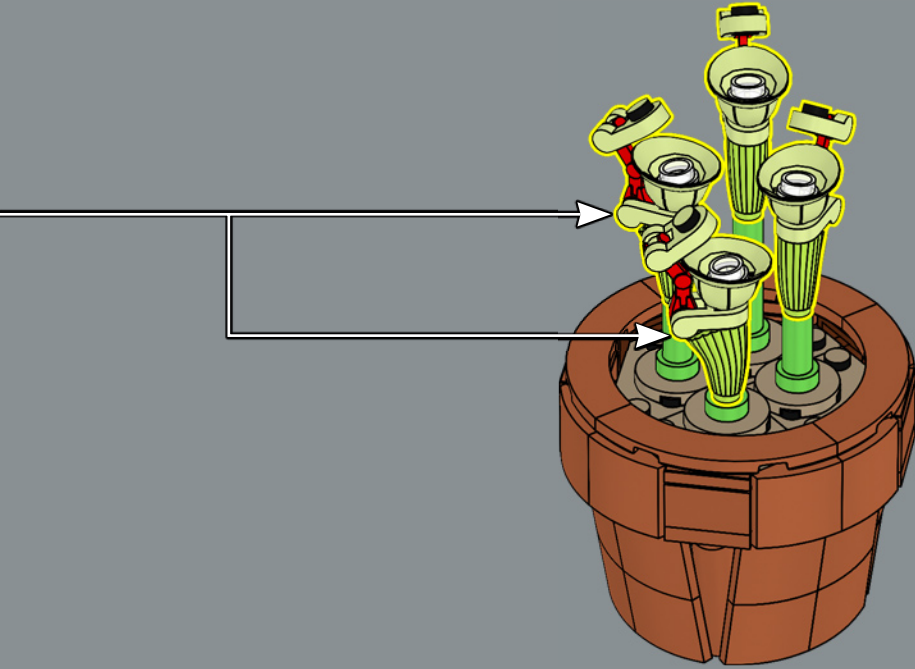



LEGO and the LEGO logo are trademarks of the LEGO Group. ©2024 The LEGO Group. 6494682