



Booklet available in English on  
Heft in deutscher Sprache erhältlich auf  
Livret disponible en français sur  
Libretto disponibile in italiano su  
Folleto en español disponible en  
如需中文版手册, 请访问





[LEGO.com/sustainable-packaging](https://www.lego.com/sustainable-packaging)



 **FR**  
**DONNEZ**  
OU  
**RECYCLEZ**

 OU  OU 

ASSOCIATION    MAGASIN    DÉCHÈTERIE

Adresses sur [quefairedemesdechets.fr](http://quefairedemesdechets.fr)

# LEGO® VIP

1. SIGN UP  
INSCRIVEZ-VOUS  
REGÍSTRATE

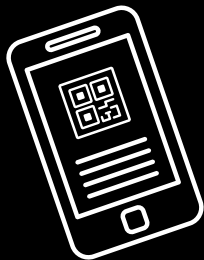

2. EARN POINTS  
FOR PURCHASES  
GAGNEZ DES  
POINTS POUR  
VOS ACHATS  
GANA PUNTOS  
POR TUS COMPRAS

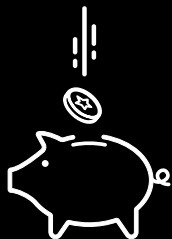

3. REDEEM POINTS FOR REWARDS,  
EXPERIENCES, DISCOUNTS & MORE  
ÉCHANGEZ DES POINTS CONTRE DES  
RÉCOMPENSES, DES EXPÉRIENCES,  
DES RÉDUCTIONS ET PLUS ENCORE  
CANJEA PUNTOS POR RECOMPENSAS,  
EXPERIENCIAS, DESCUENTOS Y  
MUCHO MÁS





# CULTIVATE YOUR CREATIVE FINGER

🪴 'These humble but prolific terracotta pots are the latest addition to our LEGO® Botanical Collection – three groups of iconic and exotic plants, miniaturised to bring classic LEGO charm to your home. From humidity-loving houseplants to desert-dwelling succulents and peculiar carnivores, this vibrant mix of plants works as a group or in smaller sets of three, keeping their colour and their fun year-round. With instructions created to make it easy for you to invite friends or loved ones to join, we hope you'll enjoy your conservatory together!'

**THEO BONNER**  
*LEGO® Model Designer*





## TROPICAL PLANTS

▣ Tropical rainforests cover only around 6% of the Earth's surface, yet they are home to nearly two-thirds of all plant species, including plants with medicinal properties used in the treatment of a variety of illnesses. The warm, humid conditions allow thousands of vibrant, lush flowers, trees and bushes to thrive and serve as shelter and nourishment for animals and humans alike.



*(Oxalis triangularis)*

**FALSE SHAMROCK**

A perennial plant native to Argentina, Bolivia, Brazil, Paraguay and Peru.



*(Crassula ovata)*

**JADE PLANT**

A large succulent native to South Africa and Mozambique.



*(Anthurium andraeanum)*

**LACELEAF**

A flowering plant native to Columbia and Ecuador.

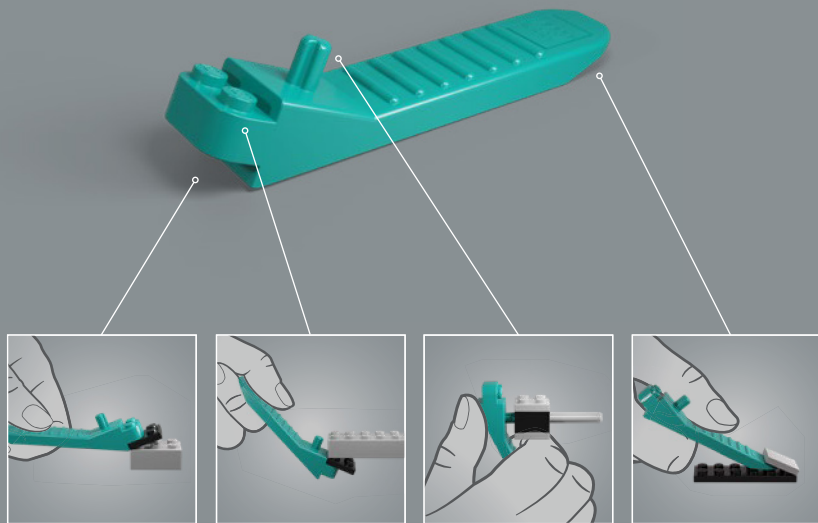





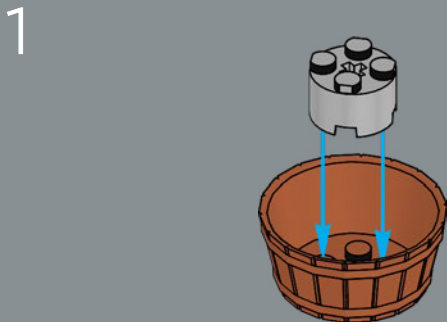
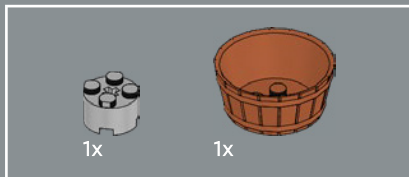

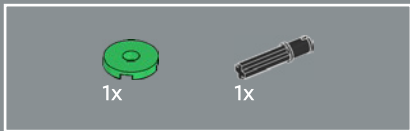

2

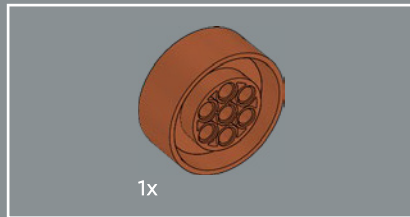
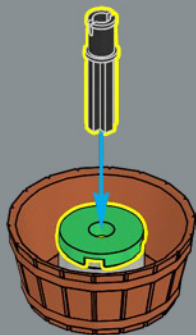

3

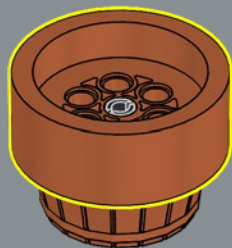



4

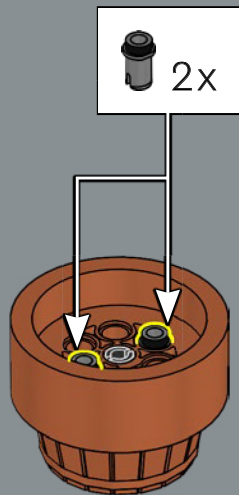

5

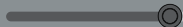



6

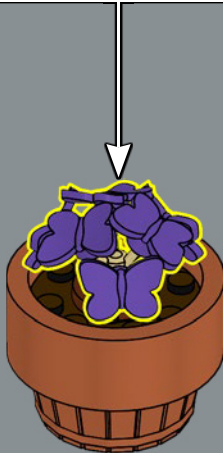
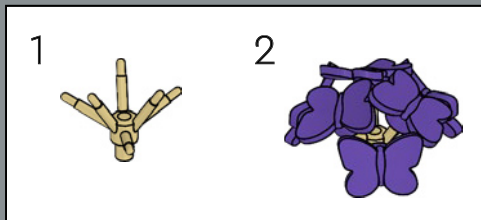

At a glance, *Oxalis triangularis* could be mistaken for a large group of butterflies, so what better way to capture this plant's iconic look than by using the LEGO® butterfly in a brand-new colour.

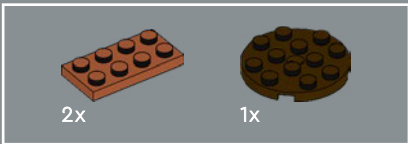
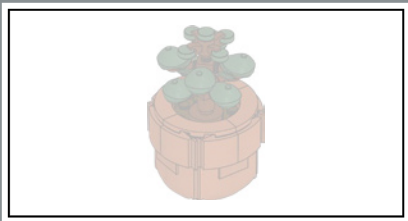

1

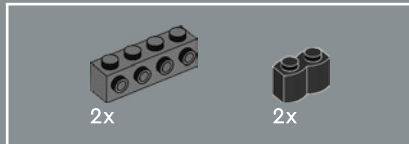
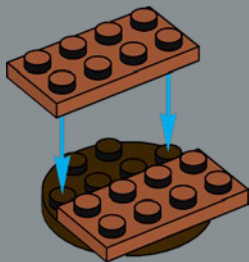

2

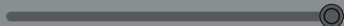
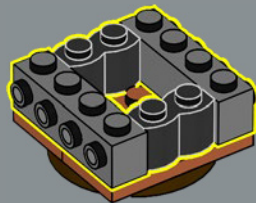

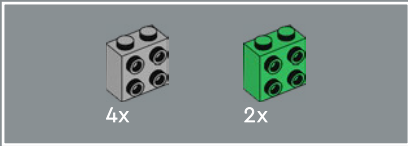

3

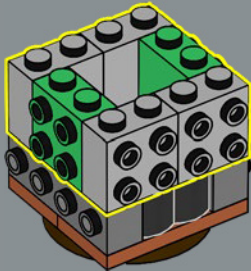

4

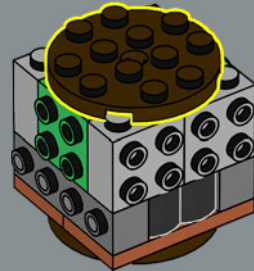

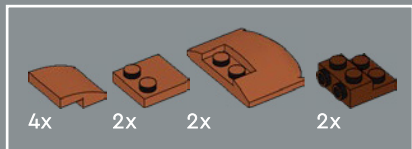

5

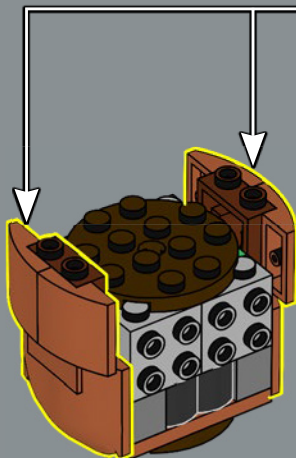
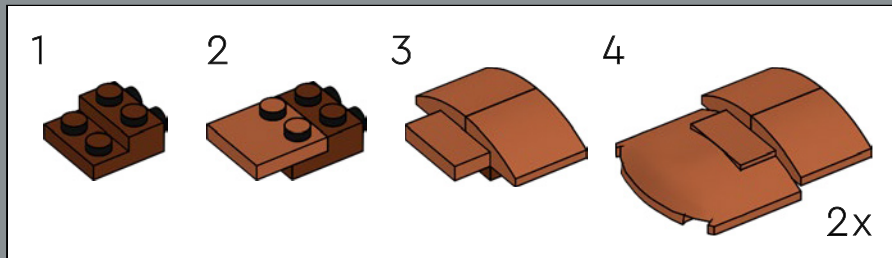



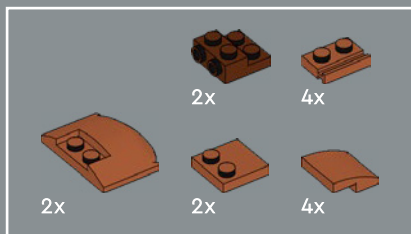

6

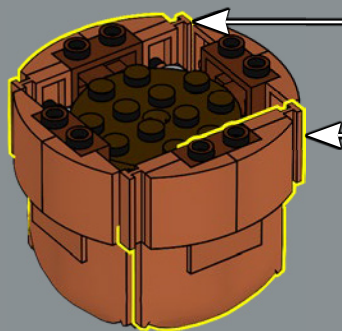
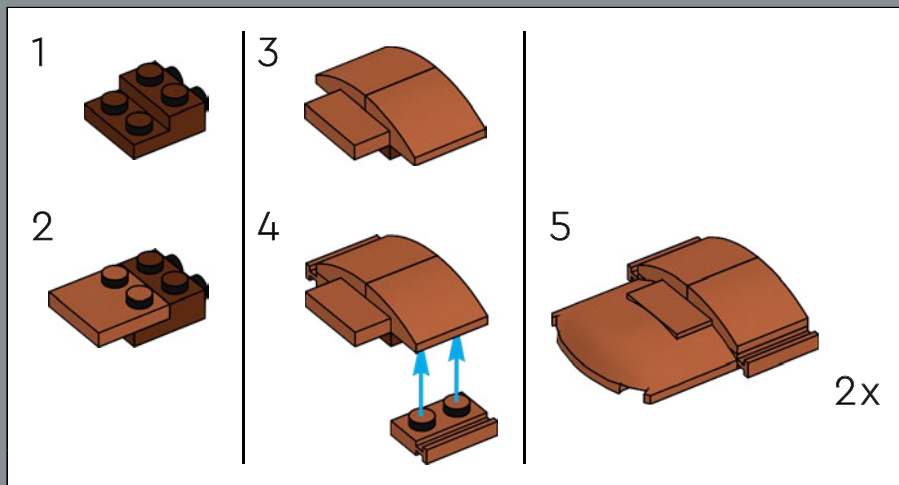

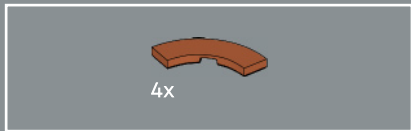

Have you ever considered learning the art of growing bonsai trees?  
Jade plants grow quickly, are very accommodating and can easily  
be trimmed to your liking.

7

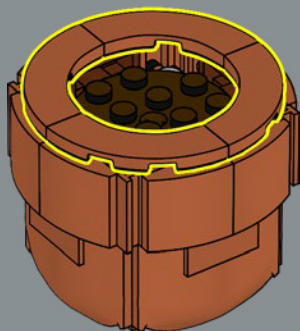



8



9

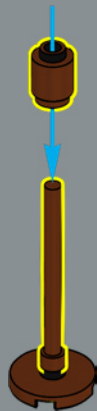



10

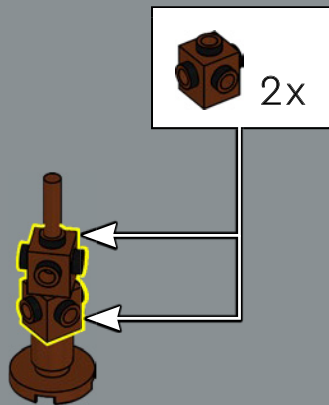

11

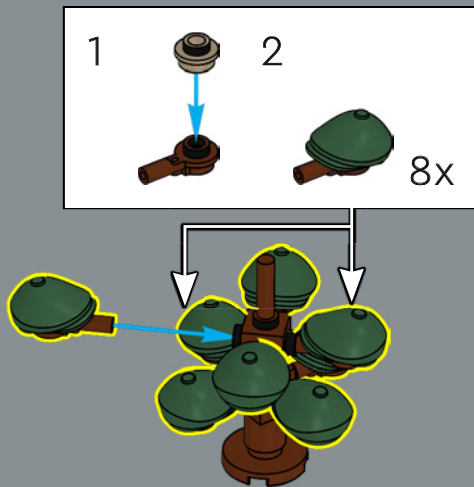



12

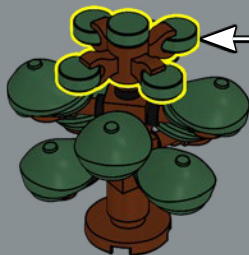

13

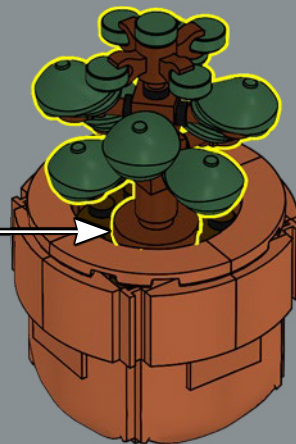

Extra! Extra! Read all about it! Flat cap in a new colour! To replicate the thick leaves of the jade plant, we used eight LEGO® flat caps first seen in the Newspaper Kid Collectible LEGO Minifigure.

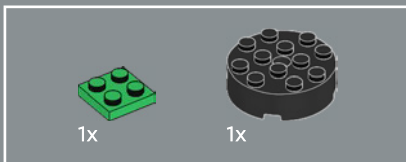
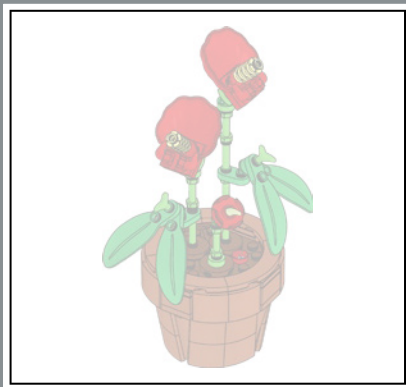

1

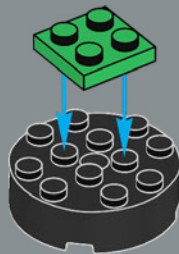

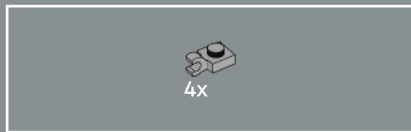

2

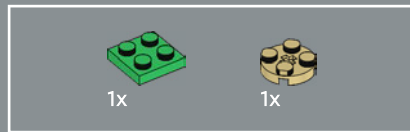
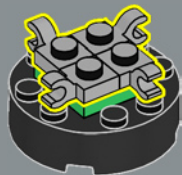

3

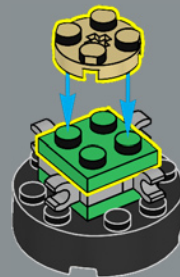

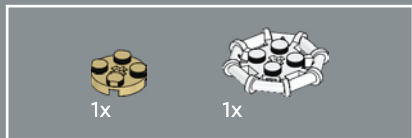

4





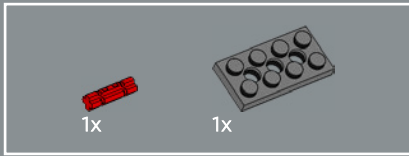

5

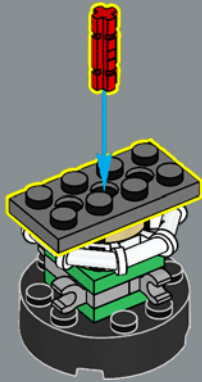

6



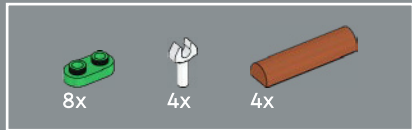

7

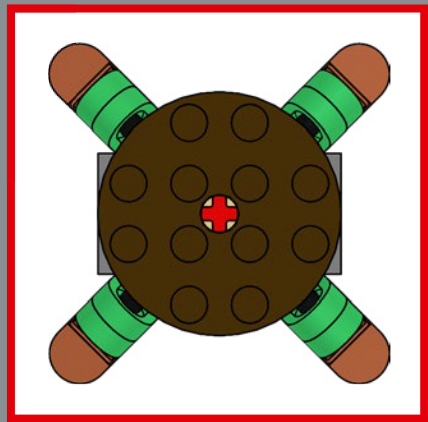
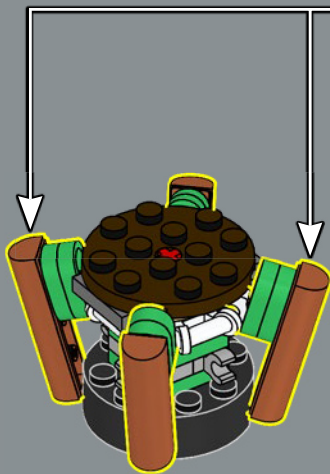
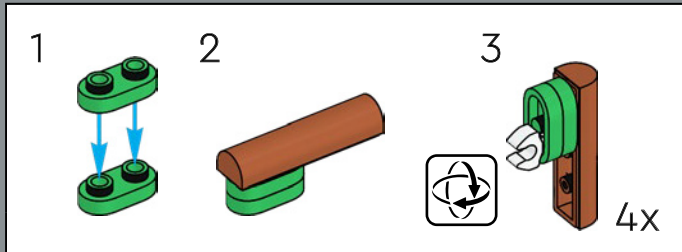

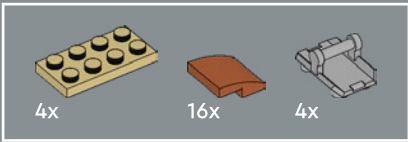

8

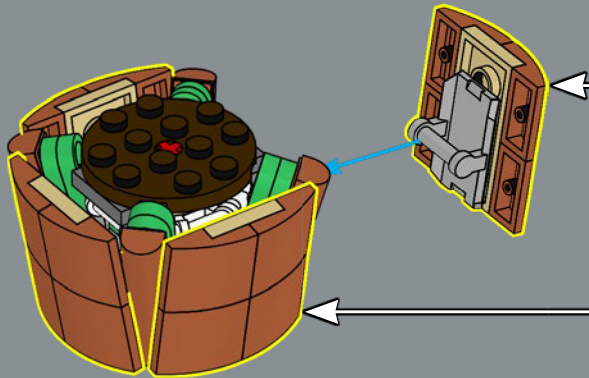
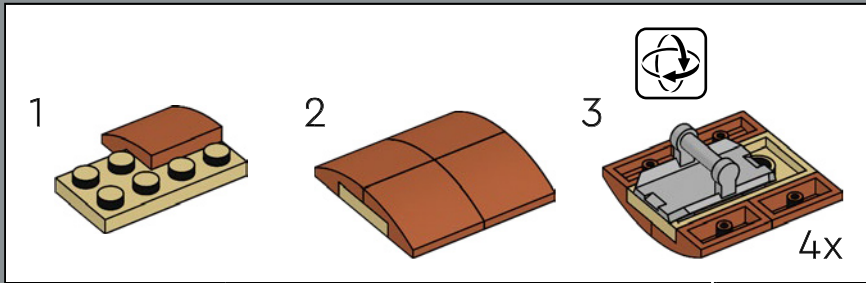

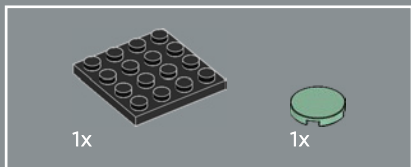
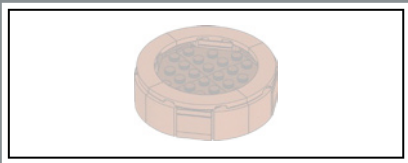

9

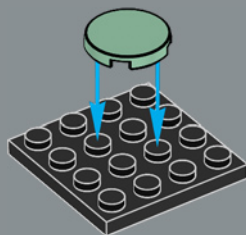



10

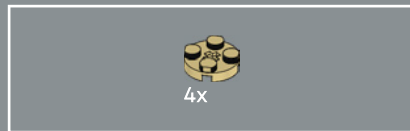
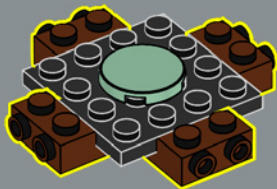

11

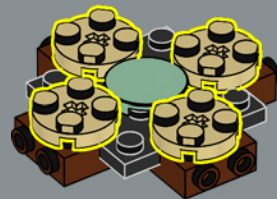



12

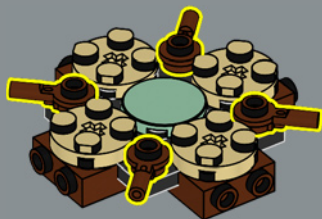

13

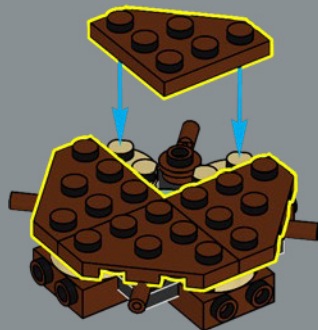



14

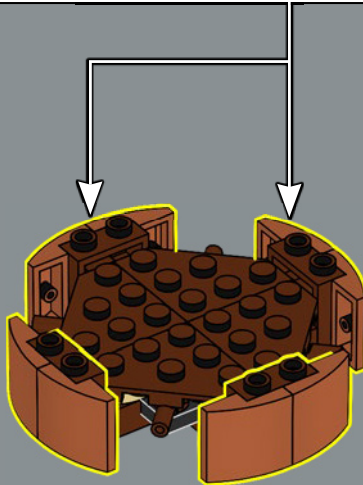
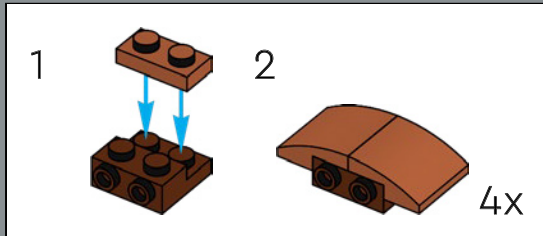



15

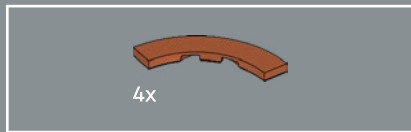
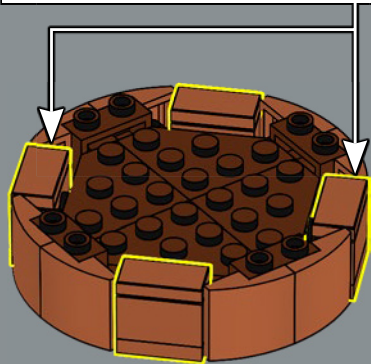
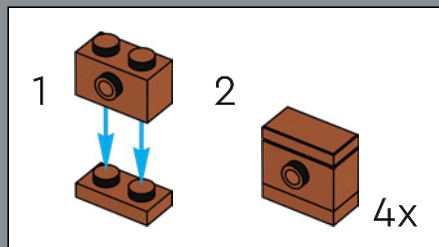

16

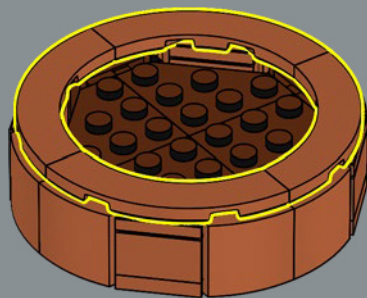



Laceleaves are susceptible to pests like aphids and spider mites, so having a hungry ladybug in the pot is a good way to keep your plant healthy.

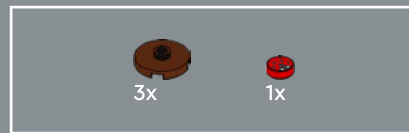

17

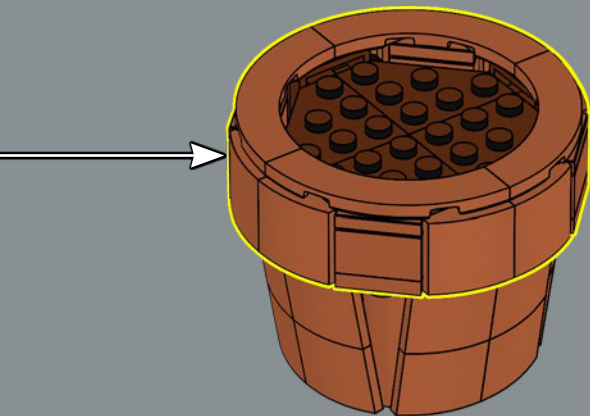

18

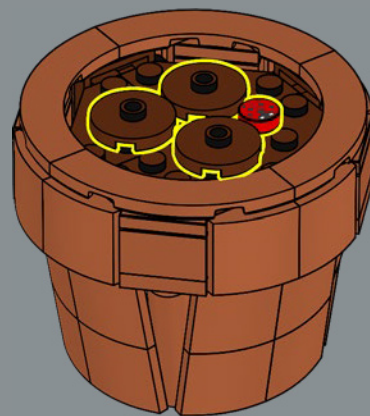

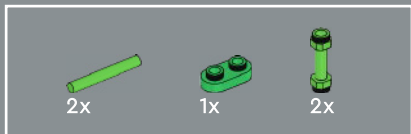

19

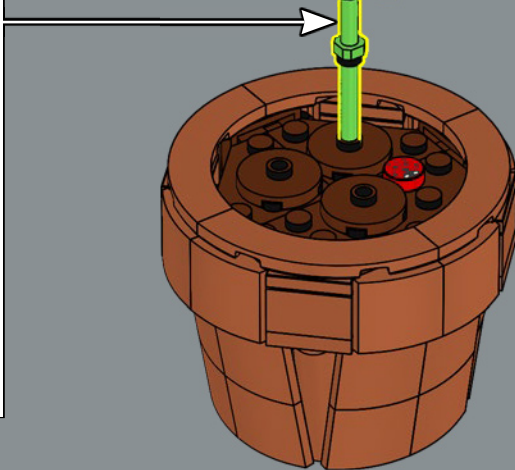
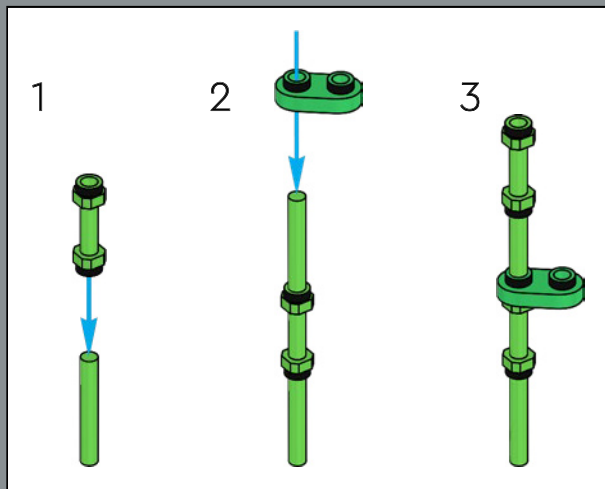

You may also know laceleaf (or Anthurium) by one of its many other names, for example, flamingo flower or painter's palette. We love the abundance of alliteration here!

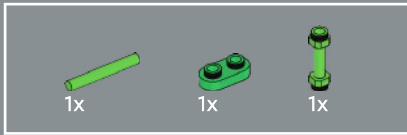

20

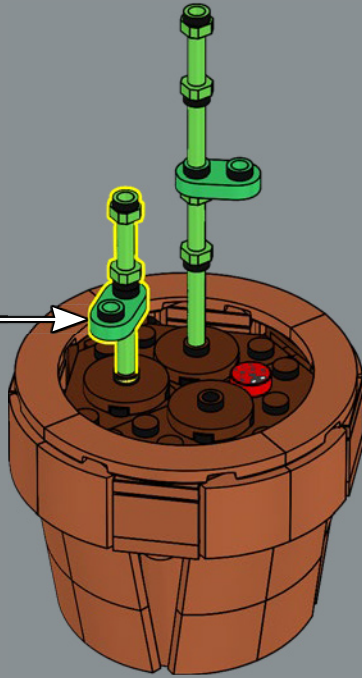
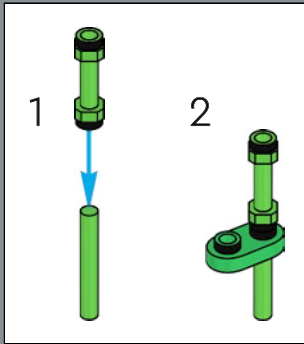

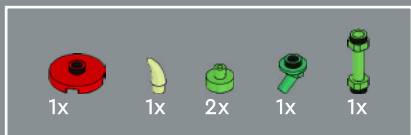

21

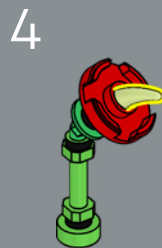
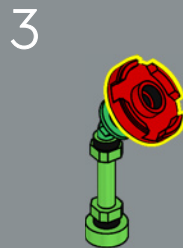
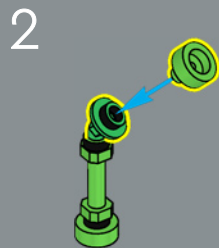
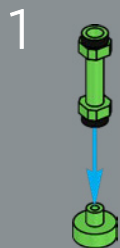

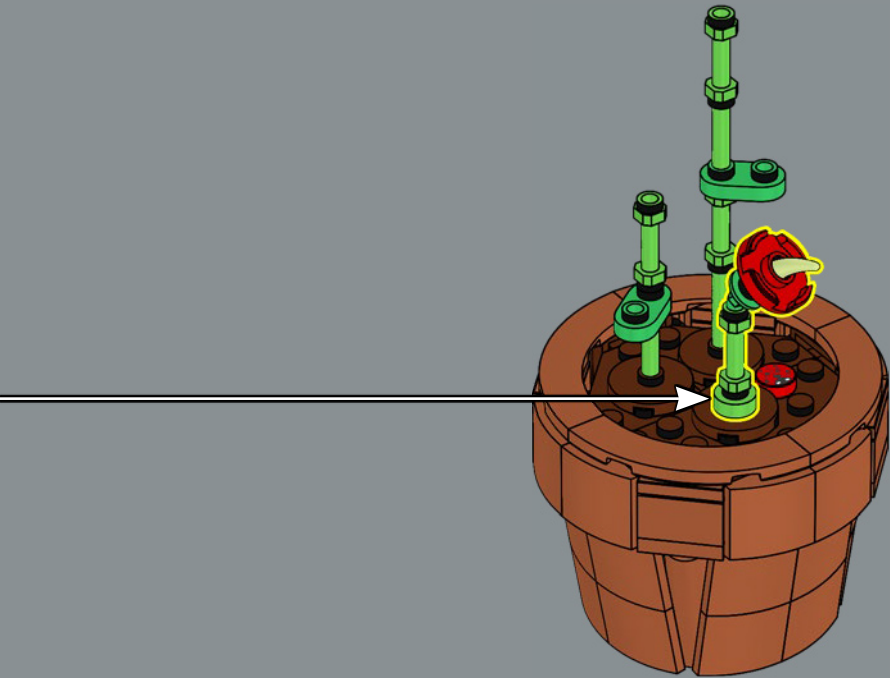

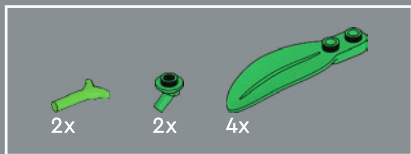

22

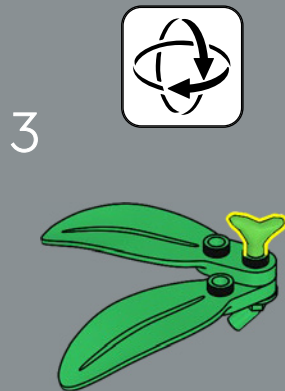
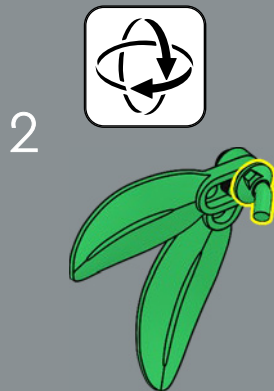
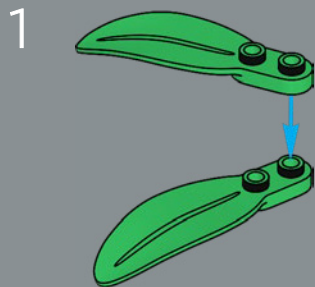

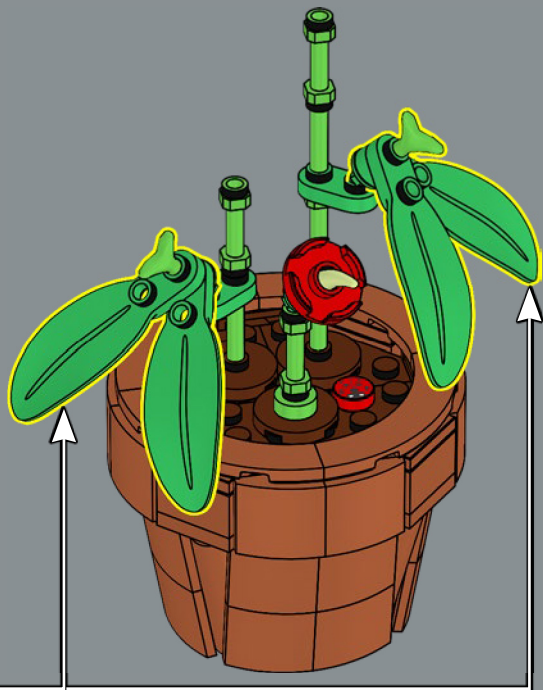

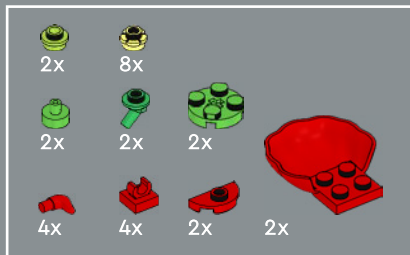
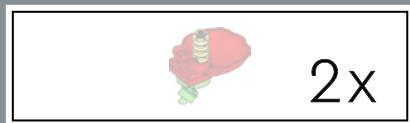

23

1

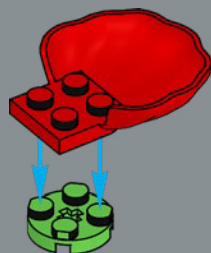

2

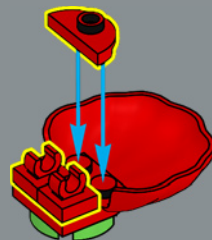



To capture the iconic ridged flower of the laceleaf, we used LEGO® clam shell elements in a new colour.

3

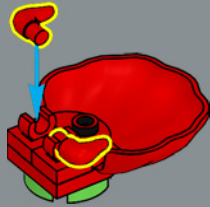

4



5

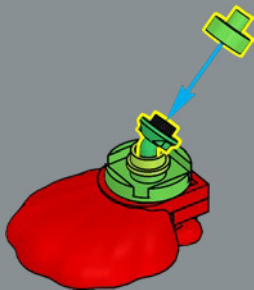

6

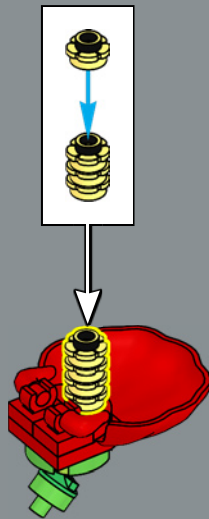

2x

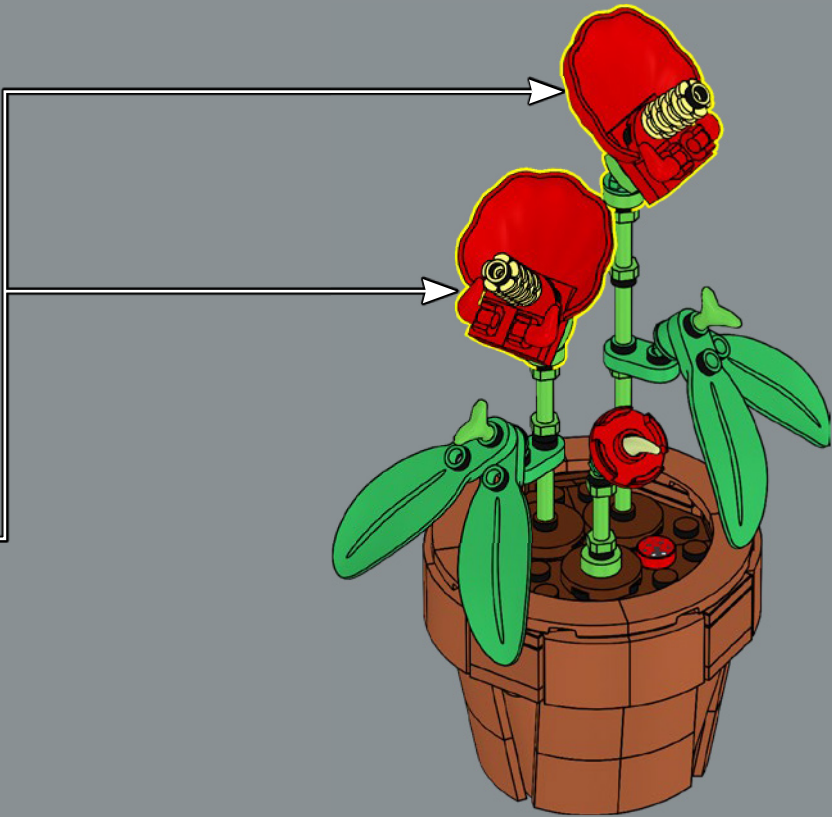



LEGO and the LEGO logo are trademarks of the LEGO Group. ©2024 The LEGO Group. 6494681